

# 1.25mm (0.049") PITCH CONNECTOR

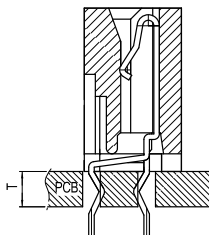

FPC/FFC Connector  
Housing

**12511HS Series**  
**DIP, NON-ZIF(VERTICAL Through Hole)**  
**Straight**

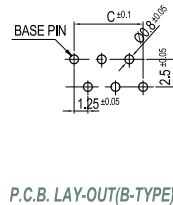
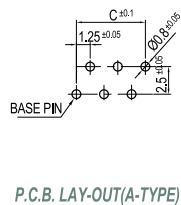
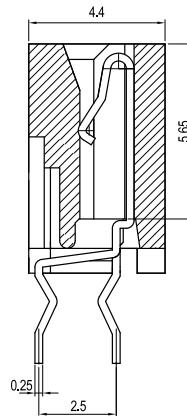
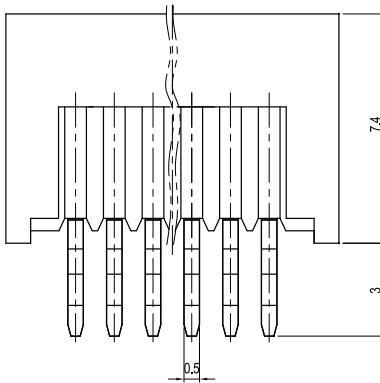
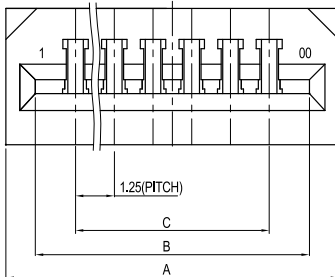
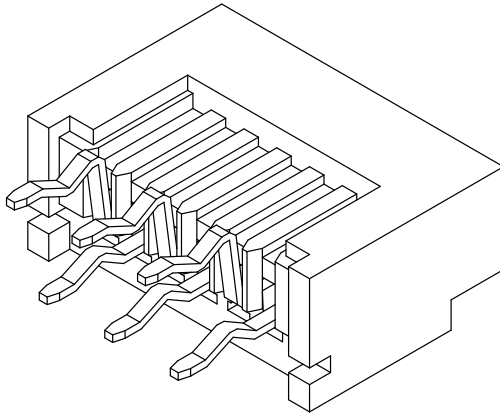

**PARTS NO.**

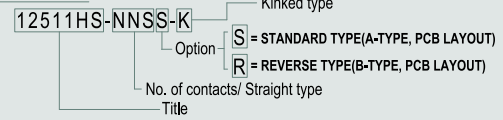

**Material**

I/NO	DESCRIPTION	TITLE	MATERIAL
1	HOUSING	12511HS	PBT, UL 94V Grade
2	TERMINAL		Phosphor Bronze & Tin plated

**Available Pin**

PARTS NO.	A	B	C
12511HS-04SS-K	8.25	6.35	3.75
12511HS-05SS-K	9.50	7.60	5.00
12511HS-06SS-K	10.75	8.85	6.25
12511HS-07SS-K	12.00	10.10	7.50
12511HS-08SS-K	13.25	11.35	8.75
12511HS-09SS-K	14.50	12.60	10.00
12511HS-10SS-K	15.75	13.85	11.25
12511HS-11SS-K	17.00	15.10	12.50
12511HS-12SS-K	18.25	16.35	13.75
12511HS-13SS-K	19.50	17.60	15.00
12511HS-14SS-K	20.75	18.85	16.25
12511HS-15SS-K	22.00	20.10	17.50
12511HS-16SS-K	23.25	21.35	18.75
12511HS-17SS-K	24.50	22.60	20.00
12511HS-18SS-K	25.75	23.85	21.25
12511HS-19SS-K	27.00	25.10	22.50
12511HS-20SS-K	28.25	26.35	23.75
12511HS-21SS-K	29.50	27.60	25.00
12511HS-22SS-K	30.75	28.85	26.25
12511HS-23SS-K	32.00	30.10	27.50
12511HS-24SS-K	33.25	31.35	28.75
12511HS-25SS-K	34.50	32.60	30.00
12511HS-26SS-K	35.75	33.85	31.25
12511HS-27SS-K	37.00	35.10	32.50
12511HS-28SS-K	38.25	36.35	33.75
12511HS-29SS-K	39.50	37.60	35.00
12511HS-30SS-K	40.75	38.85	36.25
12511HS-31SS-K	42.00	40.10	37.50
12511HS-32SS-K	43.25	41.35	38.75
12511HS-33SS-K	44.50	42.60	40.00
12511HS-34SS-K	45.75	43.85	41.25
12511HS-35SS-K	47.00	45.10	42.50
12511HS-36SS-K	48.25	46.35	43.75
12511HS-37SS-K	49.50	47.60	45.00
12511HS-38SS-K	50.75	48.85	46.25
12511HS-39SS-K	52.00	50.10	47.50
12511HS-40SS-K	53.25	51.35	48.75

**Specification**

ITEM	SPEC
Voltage Rating	AC/DC 250V
Current Rating	AC/DC 1A
Operating Temperature	-25°C ~ +85°C
Contact Resistance	30mΩ MAX
Withstanding Voltage	AC500V/1min
Insulation Resistance	500MΩ MIN
Applicable Wire	-
Applicable P.C.B	1.2 ~ 1.6mm
Applicable FPC/FFC	0.30±0.05mm
Solder Height	-
Crimp Tensile Strength	-
UL FILE NO	-