

# OPERATION MANUAL

## FOR YC tools



The Quality Connection

(HAND CRIMP TOOL FOR LOOSE PIECE OPEN BARREL TERMINALS)

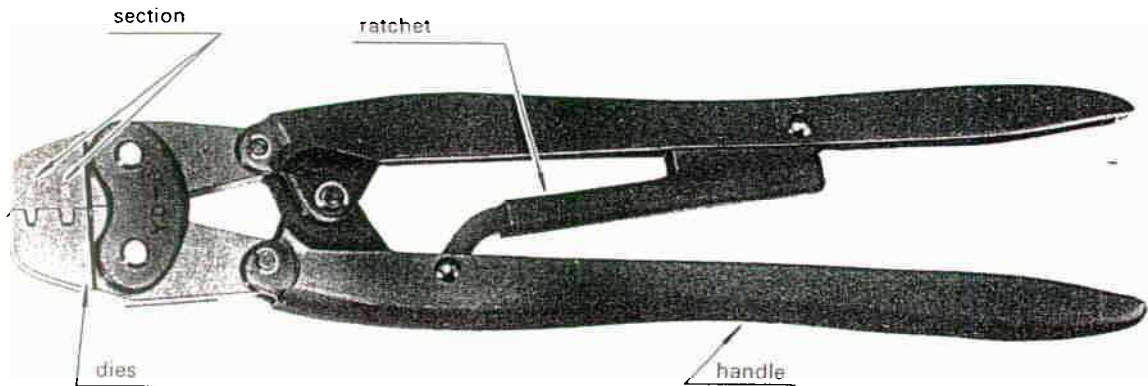

### 1. General

The YC series hand crimp tools are used to crimp loose piece open barrel terminals to wire in the recommended wire range for each terminal. Each tool has two crimping sections (A & B). Please refer to the chart to find which section should be used. Some tools come equipped with a locator spring to aid in positioning of the terminal.

### 2. Crimp Operation

- (1) Squeeze handles until the ratchet releases and handles open.
- (2) Position a terminal in A or B section as shown in Fig. 1.
- (3) If the tool is the locator-equipped type, place the terminal as shown in Fig. 3, so that the locator comes between the wire barrel and the insulation barrel.
- (4) Squeeze handles gently until the terminal is held by the dies per Fig. 2. Do not deform the terminal at this stage.
- (5) Now insert a wire, which is stripped per Fig. 4 into the barrels of the terminal.
- (6) Squeeze handles completely until the ratchet releases, holding the wire by hand in the proper position.
- (7) Open handles, remove the crimped terminal and inspect it. (See Fig. 5. )

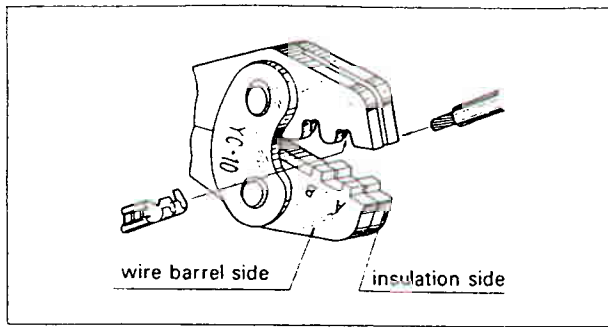

Fig. 1

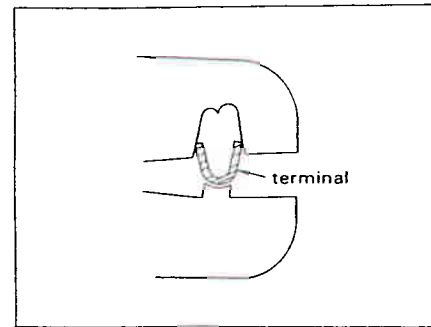

Fig. 2

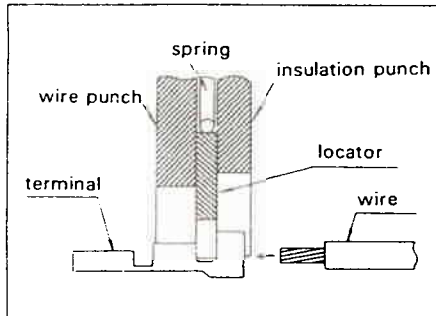

Fig. 3

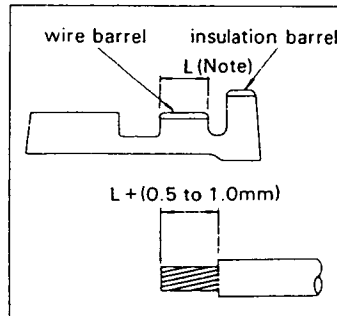

Fig. 4

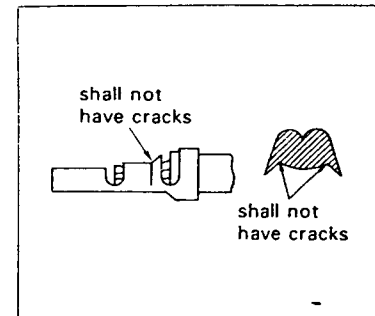

Fig. 5

Note: Refer to catalog for dimension L of barrel length.

### 3. Suggestions

- a. Do not use tool if broken or damaged in any way. Return to JST or the nearest representative. Do not attempt to repair or adjust dies or ratchet.
- b. Periodically oil all parts of the tool and store in paper or plastic bag when not in use.
- c. To check if a wire is crimped correctly, measure wire tensile strength. Consult JST if wire tensile strength specifications are needed.
- d. Make sure correct tool and section are used for each terminal.
- e. Do not abuse tool or use in a manner not intended.
- f. The ratchet mechanism does not allow handles to open until crimping is completed. Do not open handles by force.
- g. Do not use the tool with rust, damage or foreign particles on the dies.
- h. When hand crimping board-in terminals (\*\* marked ones), care should be taken not to contaminate their solder tails, as with greasy or oily fingers. If a solder problem arises, some cleaning of the tips of the terminal may be advisable.
- i. Before operation, make sure:—
  - Dies are clean without damage, rust or dirt.
  - Ratchet mechanism functions well.
  - Terminals are properly crimped. (Try a couple of samples and check the appearance, etc.)
- j. There are no adjustments for crimp heights in this tool. For improved crimping, please consider the purchase or lease of one of JST's crimp machine.
- k. The YC-2A, locator-equipped type of YC-2, is to be applied to o-marked terminals only.
- l. The prefix 'B' or 'L' in the terminal part no. denotes the terminal barrel configuration as shown below. The chain terminals can be terminated with the YC type crimping tool if they are first cut into individual contacts (as in the case of end to end terminals) or cut off their carrier strip (as in the case of side terminals). In that case, the barrel condition is as described with the suffix 'B'.
- m. The crimp height is not adjustable, therefore, applicable wires are limited. Check the appearance and the tensile strength for every kind of wire.
- n. For any questions, please contact JST.

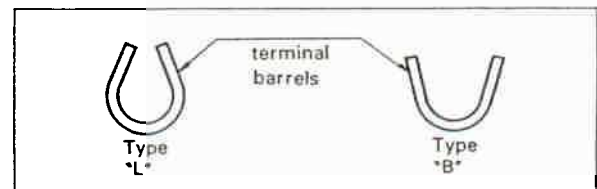

Fig. 6

In line with a policy of continual product development, JST reserves the right to change the specifications of the goods at any time and without prior notice.