

# GaAs Constant Gamma Hyperabrupt Tuning Varactors MA46410 thru 480 Series

V3.00

## Features

- Constant Gamma = 1.0, 1.25 or 1.5
- High Q (up to 4000 at -4 Volts)
- Larger Capacitance Change with Voltage
- More Linear Frequency Tuning
- High and Nearly Constant Modulation Sensitivity

## Description

The MA46450, MA46470 and MA46410 series of tuning varactors are hyperabrupt junction Gallium Arsenide diodes featuring constant gamma 1.0 (MA46450 series), 1.25 (MA46470 series) or 1.5 (MA46410 series). These diodes offer high Q (up to 4000) permitting excellent tuning performance from VHF through Ka band. Each part in this series exhibits the large change in capacitance versus bias voltage characteristic of hyperabrupt junctions. The standard capacitance tolerance is  $\pm 10\%$ , with tighter tolerances available. Capacitance matching at one or more bias voltages is also available. All diode types are available in a wide selection of ceramic packages and in chip form.

## Applications

The constant gamma value of 1.0, 1.25 or 1.5 available with these diodes enables the circuit designer to produce significant improvements in circuit performance. Constant gamma tuning varactors permit more linear VCO frequency tuning than do conventional hyperabrupt tuning varactors. These varactors are particularly well suited for use in voltage tuned filters, analog phase shifters, and modulator circuits.

## Case Styles

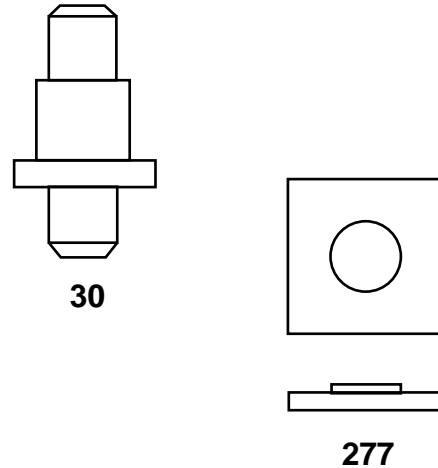

PACKAGED TUNING VARACTOR EQUIVALENT CIRCUIT

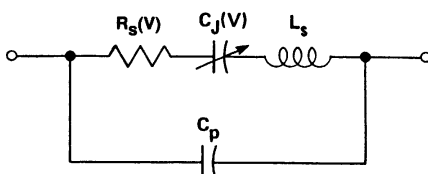

TYPICAL JUNCTION CAPACITANCE vs TUNING VOLTAGE

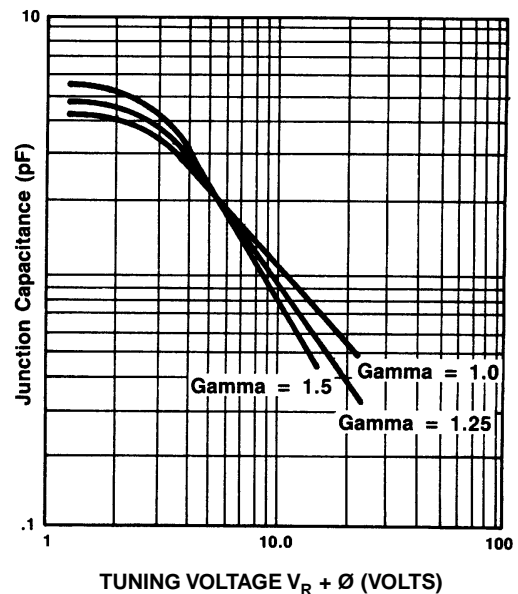

Specifications Subject to Change Without Notice.

**M/A-COM, Inc.**

North America: Tel. (800) 366-2266  
Fax (800) 618-8883

■ Asia/Pacific: Tel. +81 (03) 3226-1671  
Fax +81 (03) 3226-1451

■ Europe: Tel. +44 (1344) 869 595  
Fax +44 (1344) 300 020

## Electrical Specifications at 25°C

## MA46450 Series Gamma = 1.0

Reverse Voltage<sup>6</sup> = 22 Volts minimumGamma<sup>4</sup> = 0.9 - 1.1, V<sub>R</sub> = 2 - 20 VoltsJunction Capacitance Ratio (C<sub>J2</sub>/C<sub>J20</sub>) = 5.0 - 8.0

Model Number	Cases <sup>1</sup> Style	Total <sup>2, 3, 5, 7</sup> Capacitance @ -4 Volts Min./Max. (pF)	Total Capacitance <sup>7</sup> Ratio (2/20) Min./Max.	50 MHz Q at -4 Volts Typical
MA46450	30	0.5	2.0-3.8	4000
MA46451	30	0.7	2.9-4.4	4000
MA46452	30	1.0	3.6-5.2	3000
MA46454	30	1.5	3.8-5.5	3000
MA46455	30	1.8	4.1-6.1	3000
MA46457	30	2.2	4.1-6.1	3000
MA46459	30	3.3	4.5-6.7	2000
MA46461	30	4.7	4.8-7.2	1500

## MA46410 Series Gamma = 1.5

Breakdown Voltage<sup>6</sup> = 18 Volts minimumGamma<sup>4</sup> = 1.4 - 1.6, V<sub>R</sub> = 2 - 12 VoltsJunction Capacitance Ratio (C<sub>J2</sub>/C<sub>J12</sub>) = 6.2 - 10.84

Model Number	Case <sup>1</sup> Style	Total <sup>2, 6, 7</sup> Capacitance @ -4 Volts Min./Max. (pF)	Total Capacitance <sup>7</sup> Ratio (2/12) Min./Max.	50 MHz Q at -4 Volts Typical
MA46410	30	0.45-0.60	2.7-4.3	3000
MA46413	30	0.90-1.10	4.2-5.7	2500
MA46416	30	1.62-1.98	5.2-4.9	2500
MA46418	30	2.42-2.97	5.7-7.6	1800
MA46420	30	3.33-4.22	6.0-8.1	1800
MA46421	30	4.22-5.17	6.2-8.3	1200
MA46422	30	5.04-6.16	6.3-8.4	1200
MA46425	30	9.00-11.00	6.6-8.8	1200

## Absolute Maximum Ratings at +25°C

Parameter	Absolute Maximum
Operating Temperature*	-65°C to +175°C
Storage Temperature	-65°C to +200°C
Reverse Voltage	Breakdown Voltage

\* The maximum storage and operating temperature of the plastic 1088 case style is 125°C.

## MA46470 Series Gamma = 1.25

Reverse Voltage<sup>6</sup> = 22 Volts minimumGamma<sup>4</sup> = 1.13 - 1.38, V<sub>R</sub> = 2 - 20 VoltsJunction Capacitance Ratio (C<sub>J2</sub>/C<sub>J20</sub>) = 8.15 - 12.99

Model Number	Case <sup>1</sup> Style	Total <sup>2, 3, 5, 7</sup> Capacitance @ -4 Volts Min./Max. (pF)	Total Capacitance <sup>7</sup> Ratio (2/20) Min./Max.	50 MHz Q at -4 Volts Minimum
MA46470	30	0.5	2.2/4.1	4000
MA46471	30	0.7	3.6/5.6	4000
MA46472	30	1.0	4.8/7.4	3000
MA46473	30	1.2	4.8/7.4	3000
MA46474	30	1.5	5.0/7.4	3000
MA46475	30	1.8	6.6/8.7	3000
MA46476	30	2.0	6.6/8.7	3000
MA46477	30	2.2	6.6/8.7	3000
MA46478	30	2.7	6.4/10.0	2000
MA46479	30	3.3	6.4/10.0	2000
MA46480	30	3.7	6.8/11.0	2000
MA46481	30	4.7	6.9/11.1	1500
MA46482	30	5.6	7.2/11.5	1500
MA46483	30	6.8	7.2/11.5	1500
MA46484	30	8.2	7.2/11.5	1500
MA46485	30	10.0	7.5/12.0	1500

## Notes:

- All GaAs tuning varactors are available in chip form as well as the case styles shown on the following page. When ordering, specify the desired case by adding the case designation as a suffix to the type number.
- Case parasitics (C<sub>p</sub> and L<sub>s</sub>) are given for most case styles along with case outlines in the appendix. The Cp values listed typically have tolerances of ±0.02 pF.
- The nominal tolerance at -4 Volts is ± 10%. Closer tolerances are available upon request. By adding the suffix A to the part number, a tolerance of ± 5% at -4 Volts is guaranteed.
- The values guaranteed for gamma are measured on unpackaged chips. The total capacitance versus bias voltage curve will deviate slightly from the chip capacitance versus bias voltage curve due to the package parasitic capacitance (C<sub>p</sub>).
- Capacitance is measured at 1 MHz.
- Reverse voltage (V<sub>R</sub>) is measured at 10 microamps.
- The total capacitance and capacitance ratios shown are for diodes housed in case style 30. Other case styles will result in different values.

## Environmental Ratings PER MIL-STD-750

	MIL Method	Level
Storage Temperature	1031	See maximum ratings
Temperature Cycle	1051	10 cycles, -65°C to +175°C
Shock	2016	500 g's
Vibration	2056	15 g's
Constant Acceleration	2006	20,000 g's
Humidity	1021	10 days

Specifications Subject to Change Without Notice.

Case Styles (See appendix for complete dimensions)

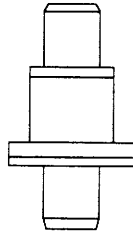

30

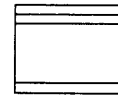

120

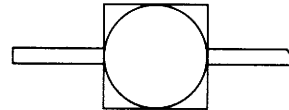

186

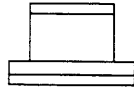

94

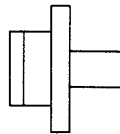
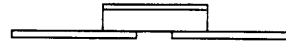

95

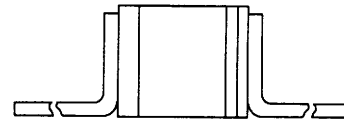

276

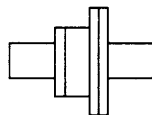
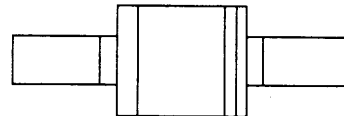

97

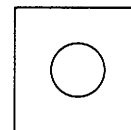

277

Typical Performance Curves

TOTAL CAPACITANCE vs REVERSE BIAS VOLTAGE ( $\gamma = 1.0$ )  
(PARTS IN CASE STYLE 30)

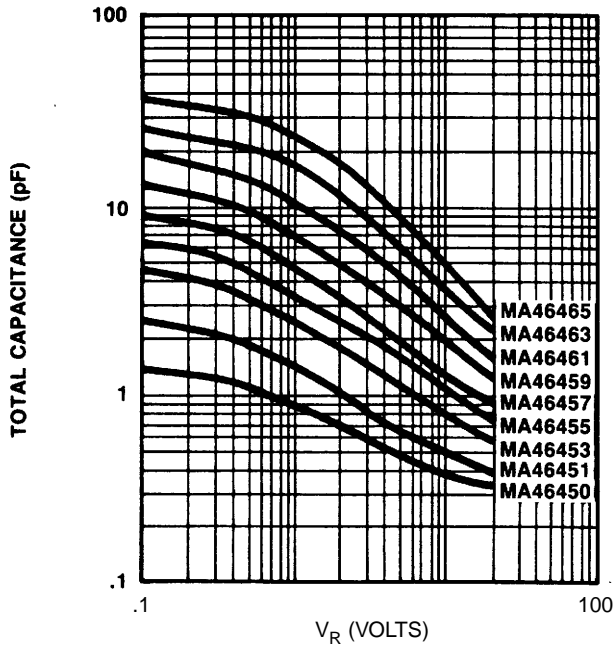

JUNCTION CAPACITANCE vs REVERSE BIAS VOLTAGE ( $\gamma = 1.0$ )  
(CHIPS)

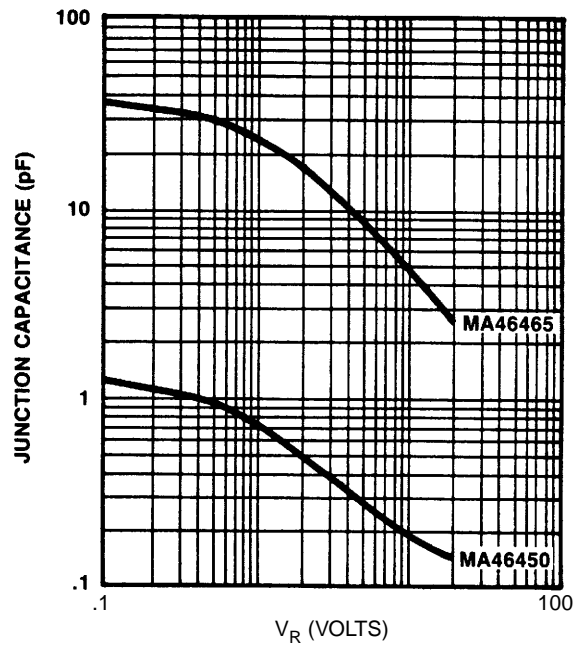

TOTAL CAPACITANCE vs REVERSE BIAS VOLTAGE ( $\gamma = 1.25$ )  
(PARTS IN CASE STYLE 30)

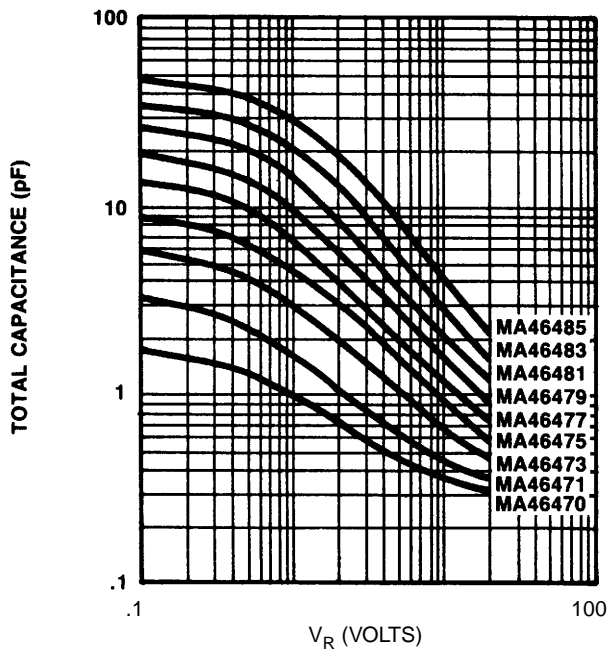

JUNCTION CAPACITANCE vs REVERSE BIAS VOLTAGE ( $\gamma = 1.25$ )  
(CHIPS)

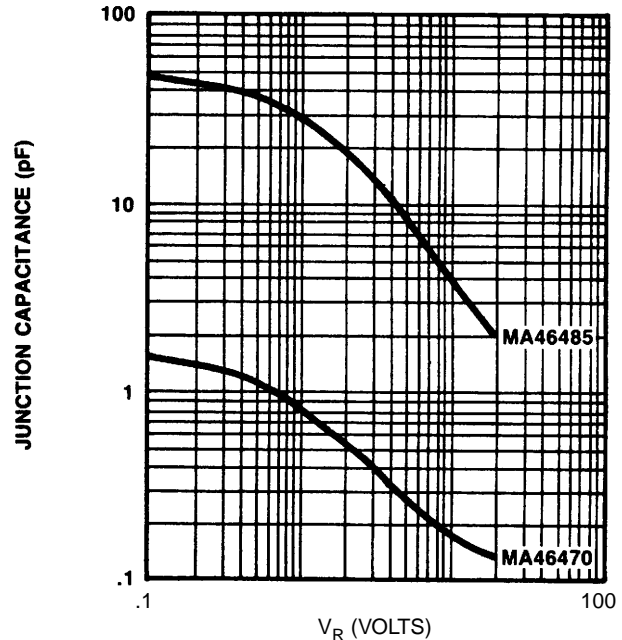

Specifications Subject to Change Without Notice.

Typical Performance Curves (Cont'd)

TOTAL CAPACITANCE vs REVERSE BIAS VOLTAGE ( $\gamma = 1.5$ )  
(PARTS IN CASE STYLE 30)

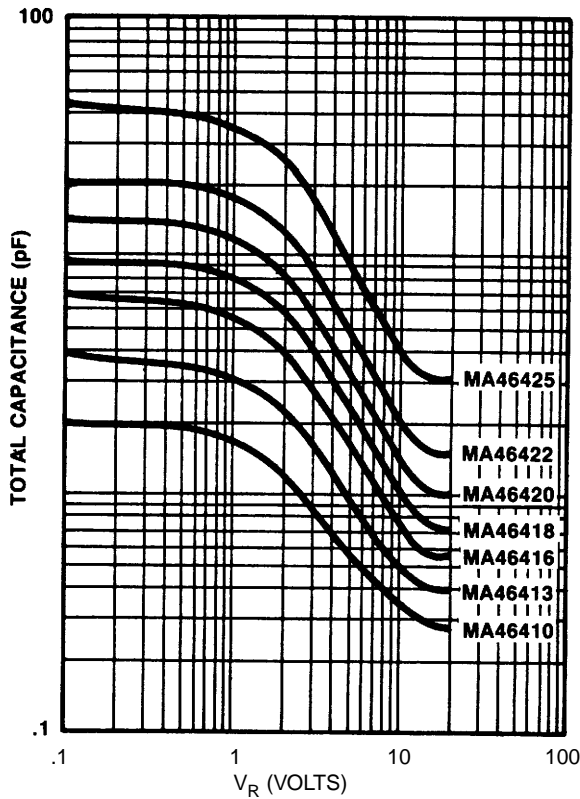

JUNCTION CAPACITANCE vs REVERSE BIAS VOLTAGE ( $\gamma = 1.5$ )  
(CHIPS)

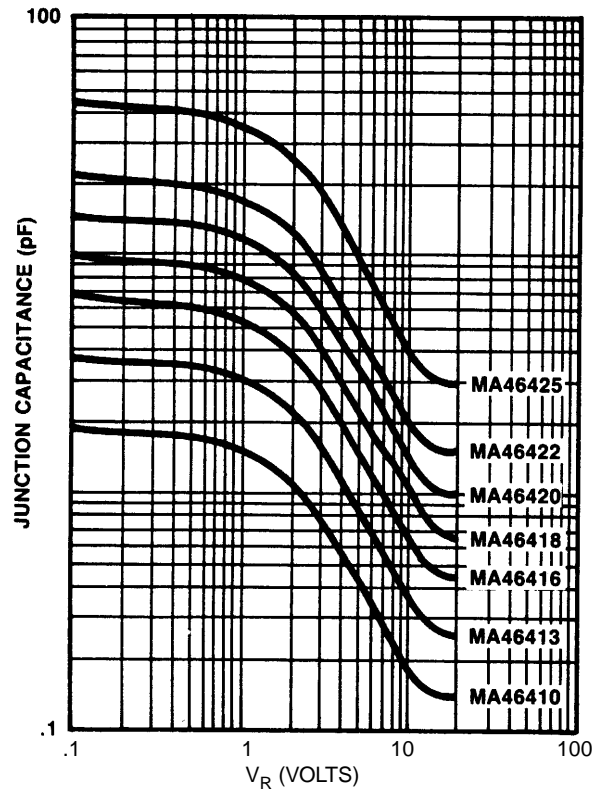

GAMMA vs VOLTAGE

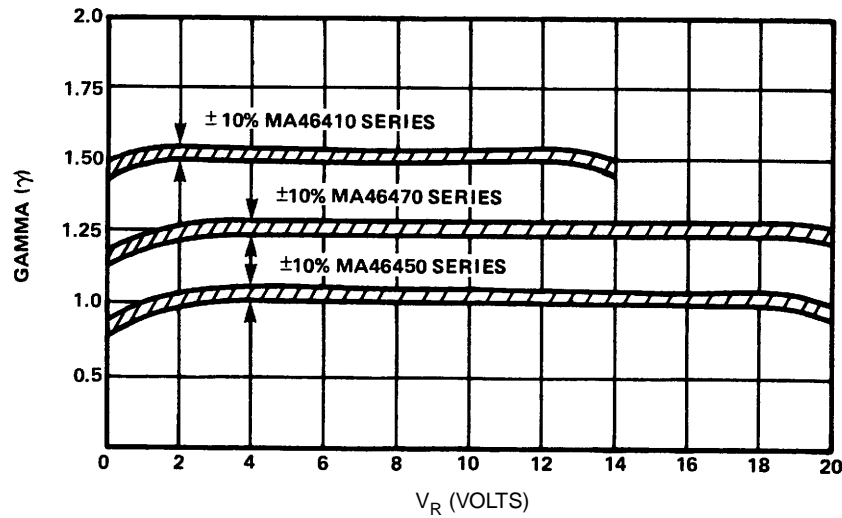

Specifications Subject to Change Without Notice.

M/A-COM, Inc.

North America: Tel. (800) 366-2266  
Fax (800) 618-8883

Asia/Pacific: Tel. +81 (03) 3226-1671  
Fax +81 (03) 3226-1451

Europe: Tel. +44 (1344) 869 595  
Fax +44 (1344) 300 020