

Mini Relay K (Open – Sealed)



Features

- Limiting continuous current 20 A
- Also available for 42 V applications

Customized Versions on Request

- 24 V versions with special contact gap
- Various contact arrangements and materials

Typical Applications

- Car alarm
- Hazard warning signal
- Heated rear screen
- Immobilizer
- Lamps front, rear, fog light
- Interior lights
- Sun roof
- Turn signal
- Wiper control

Please contact Tyco Electronics for relay application support.

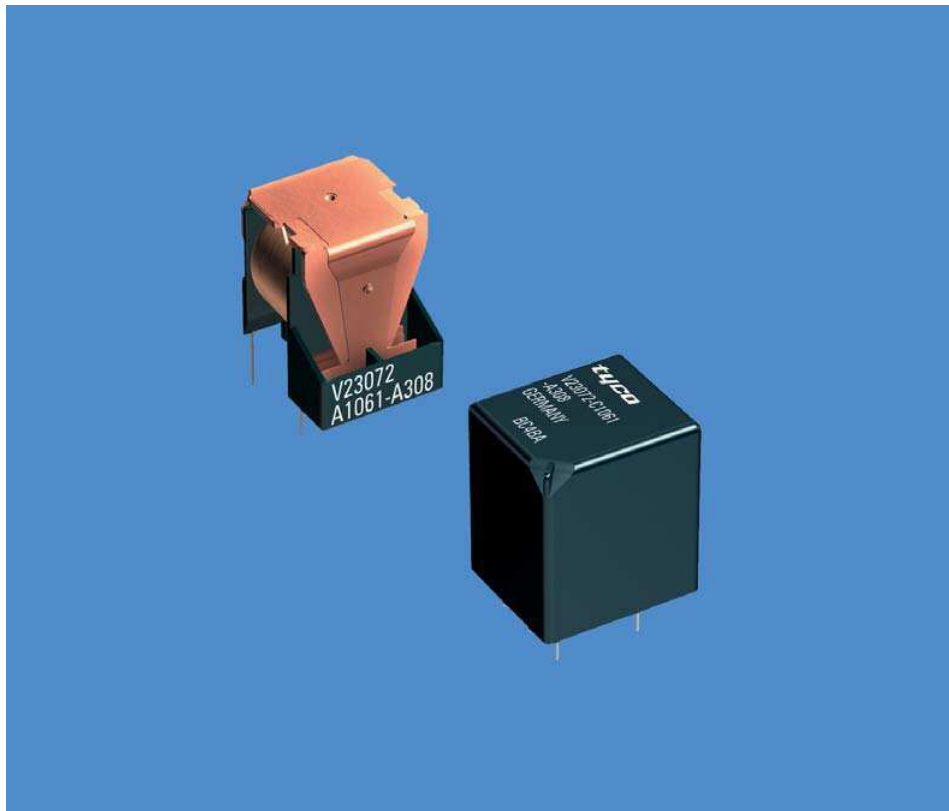

Mini_Kos_3d01

Design

- ELV/RoHS/WEEE compliant
- Open: flux tight type
- Sealed: washable type

Weight

- Approx. 8 g (0.28 oz.) open version
- Approx. 9 g (0.32 oz.) sealed version

Nominal Voltage

12 V or 24 V

Terminals

PCB terminals for assembly on printed circuit boards.

Conditions

All parametric, environmental and endurance tests are performed according to EIA Standard RS-407-A at standard test conditions unless otherwise noted:
23°C ambient temperature,
20 - 50% RH, 998.9 ±33.9 hPa.

For general storage and processing recommendations please refer to our Application Notes and especially to *Storage* in the "Glossary" page 23 or at <http://relays.tycoelectronics.com/appnotes/>

Disclaimer

All technical performance data apply to the relay as such, specific conditions of the individual application are not considered. Please always check the suitability of the relay for your intended purpose. We do not assume any responsibility or liability for not complying herewith. We recommend to complete our questionnaire and to request our technical service. Any responsibility for the application of the product remains with the customer only. All specifications are subject to change without notification. All rights of Tyco Electronics are reserved.

Mini Relay K (Open)

Dimensional Drawing

Mini Relay K Open Version

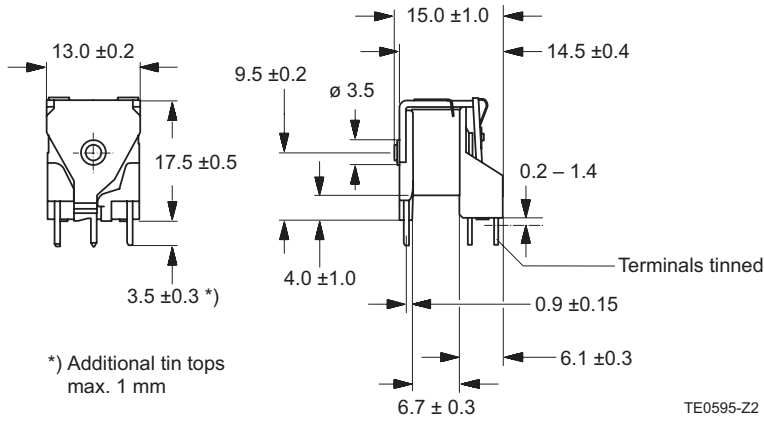

View of the Terminals (bottom view)

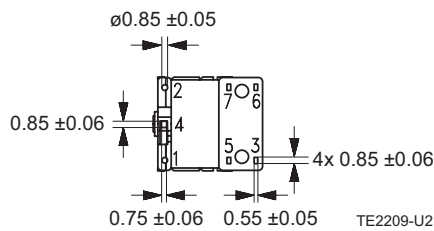

Mounting Hole Layout (bottom view)

Grid 1.25 ... 1.27 mm

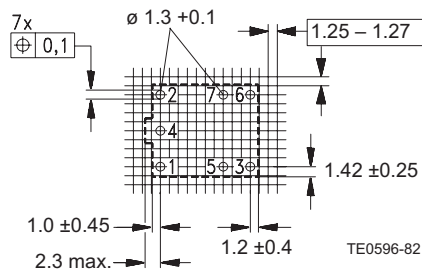

Mini Relay K (Sealed)

Dimensional Drawing

Mini Relay K Sealed Version

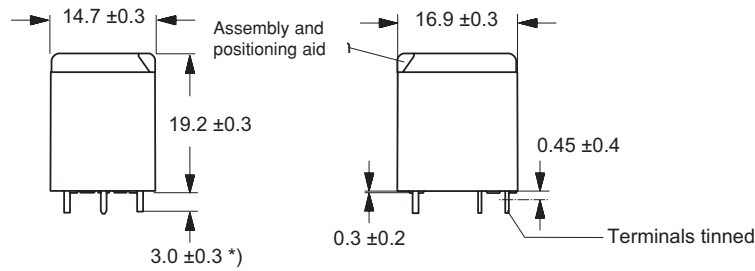

*) additional tin tops
max. 1 mm

TE1112-32

View of the Terminals (bottom view)

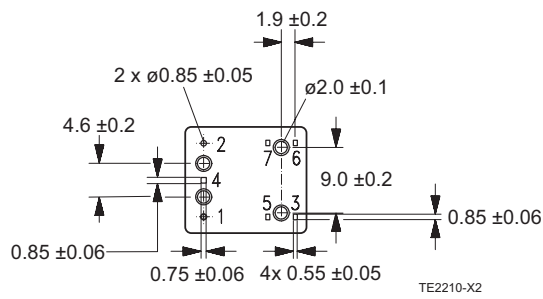

Mounting Hole Layout (bottom view)

Grid 1.25 ... 1.27 mm

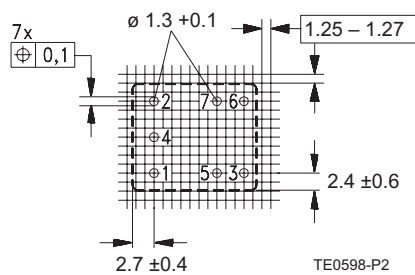

Mini Relay K (Open – Sealed)

Contact Data					
Typical areas of application	Resistive/inductive loads			Head/indicator lamps	
Contact configuration	1 Make contact/ 1 Form A	1 Changeover contact/ 1 Form C	1 Double make contact/ 1 Form U	1 Make contact/ Form A	1 Double make contact/ 1 Form U
Circuit symbol (see also Pin assignment)					
Rated voltage	12 V				
Rated current	10 A	5 A/10 A	2 x 6 A	5 A	2 x 5 A
Limiting continuous current	23°C	15 A	10 A/15 A	2 x 10 A	6 A
	85°C	10 A	5 A/10 A	2 x 6 A	2 x 5 A
Contact material	AgNi0.15			AgSnO ₂	
Max. switching voltage/power	See load limit curve				
Max. switching current ¹⁾					
On ²⁾	60 A	NC/NO 12 A/60 A	2 x 40 A	60 A ³⁾	120 A ³⁾
Off	20 A	10 A/20 A	2 x 20 A	6 A	12 A
Min. recommended load ⁴⁾	1 A at 5 V				
Voltage drop at 10 A (initial) for NC/NO contacts	Typ. 50 mV, 300 mV max.		Typ. 2 x 50 mV, 300 mV max.	Typ. 150 mV, 300 mV max.	
Mechanical endurance (without load)	> 10 ⁷ operations				
Electrical endurance	> 2 x 10 ⁵ operations 10 A, 13.5 V			> 1 x 10 ⁶ operations up to 6 x 21 W	> 1.5 x 10 ⁶ operations up to 6 x 21 W
				> 1.5 x 10 ⁵ operations 100 A on/10 A off High beam	> 7.5 x 10 ⁵ operations 100 A on/10 A off High beam

- The values apply to a resistive load or inductive load with suitable spark suppression and at maximum 13.5 V for 12 V and 27 V for 24 V load voltages.
- For a load current duration of maximum 3 s for a make/break ratio of 1:10.
- Corresponds to the peak inrush current on initial actuation (cold filament).
- See chapter Diagnostics of Relays in our Application Notes page 31 or consult the internet at <http://relays.tycoelectronics.com/appnotes/>

Load Limit Curve

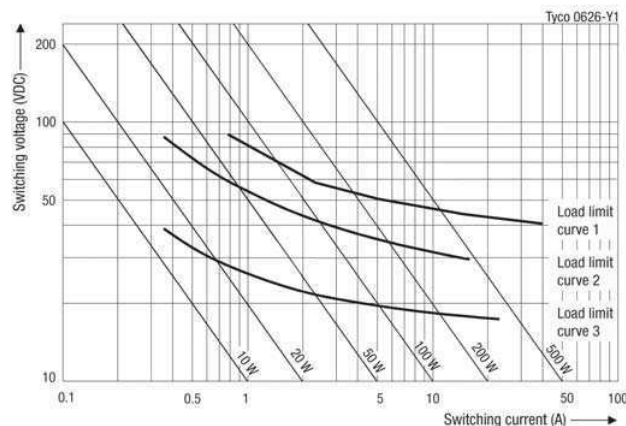

Load limit curve 1 ≙ safe shutdown, connected as Form X, load on pin 5 and 7
 Load limit curve 2 ≙ safe shutdown, no stationary arc/make contact
 Load limit curve 3 ≙ arc extinguishes during transit time (changeover contact)

Mini Relay K (Open – Sealed)

Circuit Diagram (Open and Sealed)

1 Make contact/1 Form A

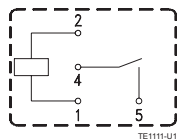

1 Double make contact/1 Form U

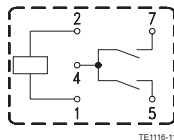

1 Changeover contact/1 Form C

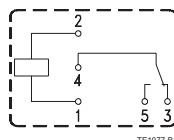

Coil Data

Available for nominal voltages	12 V / 24 V (other coils on request)
Nominal power consumption of the unsuppressed coil at nominal voltage	1.1 W
Test voltage winding/contact	500 VAC _{rms}
Maximum ambient temperature range ¹⁾	-40 to +85°C
Operate time at nominal voltage	Typ. 3 ms
Release time at nominal voltage ²⁾	Typ. 1.5 ms

¹⁾ See also operating voltage range diagram.

²⁾ For unsuppressed relay coil.

Note:

A low resistive suppression device in parallel to the relay coil increases the release time and reduces the lifetime caused by increased erosion and/or higher risk of contact tack welding.

Operating Voltage Range

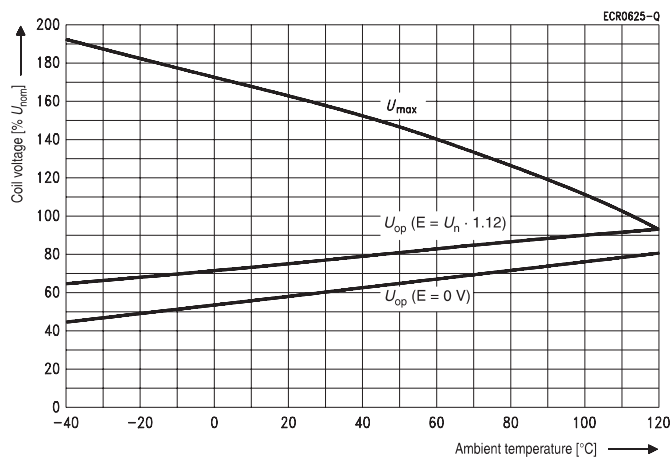

Does not take into account the temperature rise due to the contact current
E = pre-energization

Mini Relay K (Open – Sealed)

Environmental Conditions				
Temperature range, storage	Refer to <i>Storage</i> in the “Glossary” catalog page 23 or http://relays.tycoelectronics.com/appnotes/			
Test	Relevant standard	Testing as per	Dimension	Comments
Climatic cycling with condensation ¹⁾	EN ISO 6988		20 cycles	Storage 8/16 h
Temperature cycling ¹⁾	IEC 68-2-14	Na	720 cycles	-40/+85°C (dwell time 1 h)
Damp heat ¹⁾				
constant	IEC 68-2-3	Method Ca	56 days	Upper air temperature 55°C
Corrosive gas ¹⁾	IEC 68-2-42 IEC 68-2-43		10 days 10 days	
Vibration resistance	IEC 68-2-6 (sine pulse form) acceleration, acc. to position		10 - 200 Hz 23 - 35 g	No change in the switching state > 10 µs
Shock resistance	IEC 68-2-27 (half sine form single pulses) acceleration		4 - 6 ms 23 - 280 g	No change in the switching state > 10 µs
Solderability	IEC 68-2-20	Ta, Method 1	Hot dip 5 s 215°C	Aging 3 (4 h/155°C) for leaded process (T _m = 183°C) for Pb-free process (T _m = 217°C)
Resistance to soldering heat	IEC 68-2-20	Tb, Method 1A	Hot dip 10 s 260°C	with thermal screen
Sealing ¹⁾	IEC 68-2-17	Qc, Method 2		1 min/70°C
Flammability	UL94-HB			

¹⁾ Only sealed version

Ordering Information

Part Numbers (see table below for coil data)		Contact Arrangement	Contact Material	Enclosure	Terminals
Relay Description	Part Number				
V23072-A1061-A303	3-1393272-2	1 Form C	AgNi0.15	Open	Printed circuit
V23072-A1062-A303	5-1393272-2	1 Form C	AgNi0.15	Open	Printed circuit
V23072-A1061-A308	3-1393272-6	1 Form U, X	AgNi0.15	Open	Printed circuit
V23072-A1062-A308	5-1393272-3	1 Form U, X	AgNi0.15	Open	Printed circuit
V23072-C1061-A302	4-1393273-9	1 Form A	AgNi0.15	Sealed	Printed circuit
V23072-C1062-A302	7-1393273-6	1 Form A	AgNi0.15	Sealed	Printed circuit
V23072-C1061-A303	5-1393273-6	1 Form C	AgNi0.15	Sealed	Printed circuit
V23072-C1062-A303	7-1393273-8	1 Form C	AgNi0.15	Sealed	Printed circuit
V23072-C1061-A308	6-1393273-0	1 Form U, X	AgNi0.15	Sealed	Printed circuit
V23072-C1062-A308	8-1393273-2	1 Form U, X	AgNi0.15	Sealed	Printed circuit
V23072-C1061-A402	2-1416001-0	1 Form A (Lamp load)	AgSnO ₂	Sealed	Printed circuit
V23072-C1061-A408	1-1416001-4	1 Form U, X (Lamp/Flasher load)	AgSnO ₂	Sealed	Printed circuit

Coil Versions

Coil Data for Mini K	Rated Coil Voltage (V)	Coil Resistance ±10% (Ω)	Must Operate Voltage (V)	Must Release Voltage (V)	Allowable Overdrive¹⁾ Voltage (V)		
					at 23°C	at 85°C	
Open and sealed	V23072-**061-****	12	130	6.9	1.2	19.2	14.9
	V23072-**062-****	24	520	14.1	2.4	38.4	29.8

¹⁾ Allowable overdrive is stated with no load applied and minimum coil resistance.

Standard Delivery Packs (orders in multiples of delivery pack)

Mini K – Open: 600 pieces
Mini K – Sealed: 504 pieces