

SMD Transient Voltage Suppressor

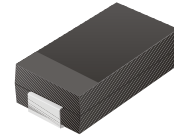

TV15C5V0-G Thru TV15C171-G

Working Peak Reverse Voltage: 5.0 - 170 Volts
 Power Dissipation: 1500 Watts
 RoHS Device



Features

- Ideal for surface mount applications
- Easy pick and place
- Plastic package has Underwriters Lab. flammability classification 94V-0
- Typical IR less than 1uA above 10V
- Fast reponse time: typically less 1nS for uni-direction, less than 5nS for bi-directiona, from 0 V to BV min.

Mechanical data

- Case: JEDEC DO-214AB molded plastic
- Terminals: solderable per MIL-STD-750, method 2026
- Polarity: Cathode band denoted
- Approx. Weight:0.21 gram

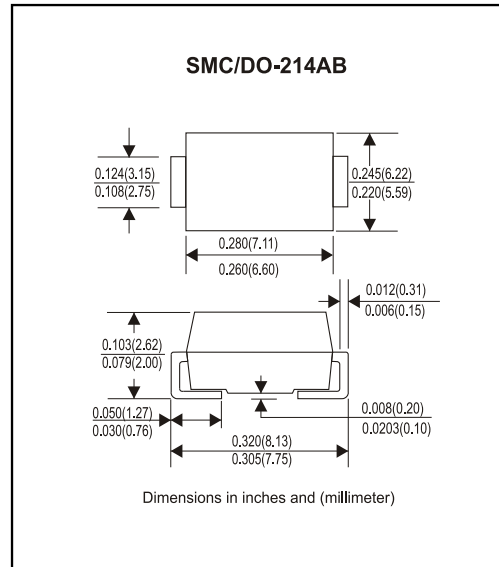

Maximum Ratings and Electrical Characteristics

Rating at 25°C ambient temperature unless otherwise specified.
 Single phase, half wave, 60Hz, resistive or inductive load.
 For capacitive load, derate current by 20%

| Characteristics | Symbol | Value | Units |
|-------------------------------------------------------------------------------------------------------------------|--------|-------------|-------|
| Peak Power Dissipation on 10/1000uS Waveform (Note 1, Fig. 1) | PPPM | 1500 | Watts |
| Peak Pulse Current of on 10/1000uS Waveform (Note 1, Fig. 3) | IPPM | See Table 1 | A |
| Steady State Power Dissipation at TL=75°C (Note 2) | PM(AV) | 5.0 | Watts |
| Peak Forfard Surge Current, 8.3mS Single Half Sine-Wave Superimposed on Rated Load, Uni-Directional Only (Note 3) | IFSM | 200 | A |
| Maximum Instantaneous Forward Voltage at 100A for Uni-Directional only (Note 3 & 4) | VF | 3.5/5.0 | Volts |
| Operation Junction Temperature Range | Tj | -55 to +150 | °C |
| Storage Temperature Range | TSTG | -55 to +150 | °C |

Note: 1. Non-Repetitive Current Pulse, per Fig. 3 and Derated above TA=25°C, per Fig. 2.
 2. Mounted on 8.0x8.0 mm² Copper Pads to Each Terminal.
 3. Measured on 8.3 mS Single Half Sine-Wave or Equivalent Square Wave, Duty Cycle=4 Pulse per Minute Maximum.
 4. VF=3.5V on TV15C5V0 thru TV15C900 Devices and VF=5.0V on TV15C101 thru TV15C171.

Rating and Characteristic Curves (TV15C5V0 Thru TV15C171)

Fig. 1 - Reverse Characteristics

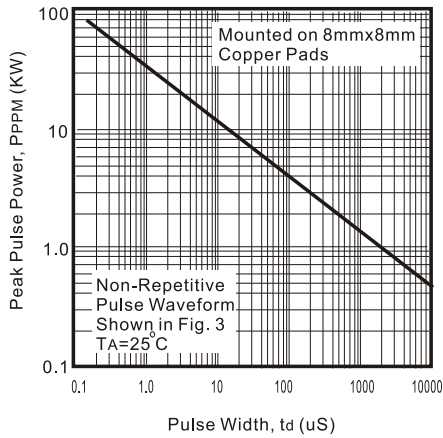

Fig. 2 - Pulse Derating Curve

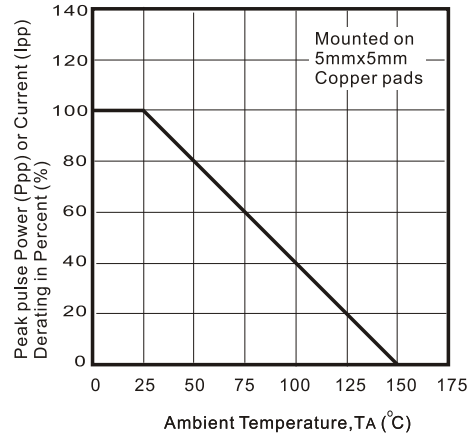

Fig. 3 - Pulse Waveform

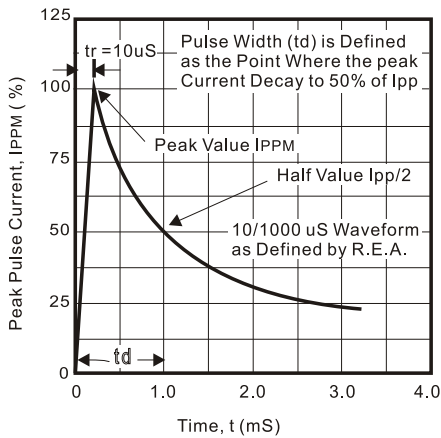

Fig. 4 - Typical Junction Capacitance for Uni-Directional Devices

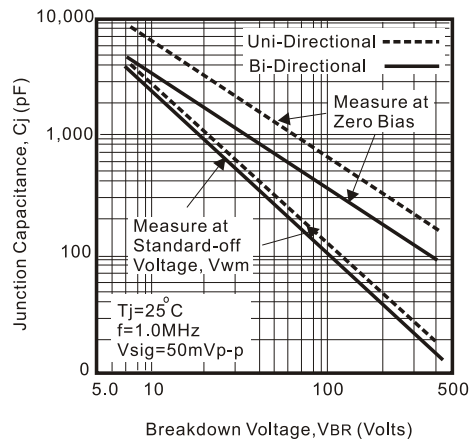

Fig. 5 - Steady State Power Derating Curve

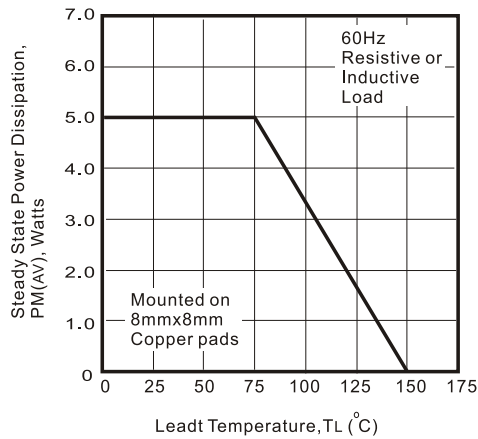
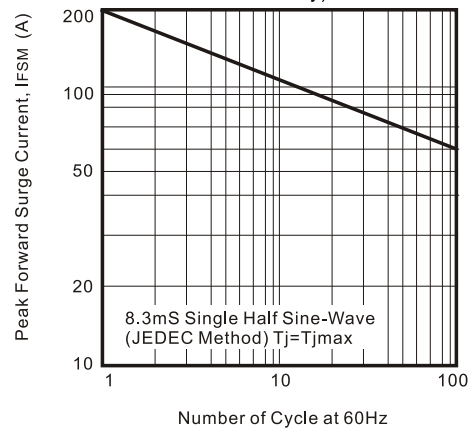

Fig. 6 - Maximum Non-Repetitive Peak Forward Surge Current (Uni-Directional Only)



SMD Transient Voltage Suppressor



SMD Diodes Specialist

Table 1. Specification

| Part No | Absolute Maximum Rating(T _a =25°C) | | | | | Electrical Characteristic(T _a =25°C) | | | | |
|----------------|-----------------------------------------------|----------------------|----------------------|----------------|------------------|-------------------------------------------------|----------------------|---------------|-----|-----|
| | V _{RWM} | V _{BR} Min. | V _{BR} Max. | I _T | I _{FSM} | Max V _C | I _{RR@VRWM} | Marking Code. | | |
| | (V) | (V) | (V) | (mA) | (A)@8.3ms | (V) | I _{PP} (A) | (uA) | UNI | BI |
| TV15C5V0K(B)-G | 5.00 | 6.40 | 7.82 | 10 | 200 | 9.6 | 156.2 | 800 | GDD | BDD |
| TV15C5V0J(B)-G | 5.00 | 6.40 | 7.07 | 10 | 200 | 9.2 | 163.0 | 800 | GDE | BDE |
| TV15C6V0K(B)-G | 6.00 | 6.67 | 8.15 | 10 | 200 | 11.4 | 131.6 | 800 | GDF | BDF |
| TV15C6V0J(B)-G | 6.00 | 6.67 | 7.37 | 10 | 200 | 10.3 | 145.6 | 800 | GDG | BDG |
| TV15C6V5K(B)-G | 6.50 | 7.22 | 8.82 | 10 | 200 | 12.3 | 122.0 | 500 | GDH | BDH |
| TV15C6V5J(B)-G | 6.50 | 7.22 | 7.98 | 10 | 200 | 11.2 | 133.9 | 500 | GDK | BDK |
| TV15C7V0K(B)-G | 7.00 | 7.78 | 9.51 | 1 | 200 | 13.3 | 112.8 | 200 | GDL | BDL |
| TV15C7V0J(B)-G | 7.00 | 7.78 | 8.60 | 1 | 200 | 12.0 | 125.0 | 200 | GDM | BDM |
| TV15C7V5K(B)-G | 7.50 | 8.33 | 10.2 | 1 | 200 | 14.3 | 104.9 | 100 | GDN | BDN |
| TV15C7V5J(B)-G | 7.50 | 8.33 | 9.21 | 1 | 200 | 12.9 | 116.3 | 100 | GDP | BDP |
| TV15C8V0K(B)-G | 8.00 | 8.89 | 10.9 | 1 | 200 | 15.0 | 100.0 | 50 | GDQ | BDQ |
| TV15C8V0J(B)-G | 8.00 | 8.89 | 9.83 | 1 | 200 | 13.6 | 110.3 | 50 | GDR | BDR |
| TV15C8V5K(B)-G | 8.55 | 9.44 | 11.5 | 1 | 200 | 15.9 | 94.3 | 10 | GDS | BDS |
| TV15C8V5J(B)-G | 8.55 | 9.44 | 10.4 | 1 | 200 | 14.4 | 104.2 | 10 | GDT | BDT |
| TV15C9V0K(B)-G | 9.00 | 10.0 | 12.2 | 1 | 200 | 16.9 | 88.7 | 5 | GDU | BDU |
| TV15C9V0J(B)-G | 9.00 | 10.0 | 11.1 | 1 | 200 | 15.4 | 97.4 | 5 | GDV | BDV |
| TV15C100K(B)-G | 10.0 | 11.1 | 13.6 | 1 | 200 | 18.8 | 79.8 | 5 | GDW | BDW |
| TV15C100J(B)-G | 10.0 | 11.1 | 12.3 | 1 | 200 | 17.0 | 88.2 | 5 | GDX | BDX |
| TV15C110K(B)-G | 11.0 | 12.2 | 14.9 | 1 | 200 | 20.1 | 74.6 | 5 | GDY | BDY |
| TV15C110J(B)-G | 11.0 | 12.2 | 13.5 | 1 | 200 | 18.2 | 82.4 | 5 | GDZ | BDZ |
| TV15C120K(B)-G | 12.0 | 13.3 | 16.3 | 1 | 200 | 22.0 | 68.2 | 5 | GED | BED |
| TV15C120J(B)-G | 12.0 | 13.3 | 14.7 | 1 | 200 | 19.9 | 75.3 | 5 | GEE | BEE |
| TV15C130K(B)-G | 13.0 | 14.4 | 17.6 | 1 | 200 | 23.8 | 63.0 | 5 | GEF | BEF |
| TV15C130J(B)-G | 13.0 | 14.4 | 15.9 | 1 | 200 | 21.5 | 69.7 | 5 | GEG | BEG |
| TV15C140K(B)-G | 14.0 | 15.6 | 19.1 | 1 | 200 | 25.8 | 58.1 | 5 | GEH | BEH |
| TV15C140J(B)-G | 14.0 | 15.6 | 17.2 | 1 | 200 | 23.2 | 64.7 | 5 | GEK | BEK |
| TV15C150K(B)-G | 15.0 | 16.7 | 20.4 | 1 | 200 | 26.9 | 55.8 | 5 | GEL | BEL |
| TV15C150J(B)-G | 15.0 | 16.7 | 18.5 | 1 | 200 | 24.4 | 61.5 | 5 | GEM | BEM |
| TV15C160K(B)-G | 16.0 | 17.8 | 21.8 | 1 | 200 | 28.8 | 52.1 | 5 | GEN | BEN |
| TV15C160J(B)-G | 16.0 | 17.8 | 19.7 | 1 | 200 | 26.0 | 57.7 | 5 | GEP | BEP |
| TV15C170K(B)-G | 17.0 | 18.9 | 23.1 | 1 | 200 | 30.5 | 49.2 | 5 | GEQ | BEQ |
| TV15C170J(B)-G | 17.0 | 18.9 | 20.9 | 1 | 200 | 27.6 | 53.3 | 5 | GER | BER |
| TV15C180K(B)-G | 18.0 | 20.0 | 24.4 | 1 | 200 | 32.2 | 46.6 | 5 | GES | BES |
| TV15C180J(B)-G | 18.0 | 20.0 | 22.1 | 1 | 200 | 29.2 | 51.4 | 5 | GET | BET |
| TV15C200K(B)-G | 20.0 | 22.2 | 27.1 | 1 | 200 | 35.8 | 41.9 | 5 | GEU | BEU |
| TV15C200J(B)-G | 20.0 | 22.2 | 24.5 | 1 | 200 | 32.4 | 46.3 | 5 | GEV | BEV |
| TV15C220K(B)-G | 22.0 | 24.4 | 29.8 | 1 | 200 | 39.4 | 38.1 | 5 | GEW | BEW |
| TV15C220J(B)-G | 22.0 | 24.4 | 26.9 | 1 | 200 | 35.5 | 42.2 | 5 | GEX | BEX |
| TV15C240K(B)-G | 24.0 | 26.7 | 32.6 | 1 | 200 | 43.0 | 34.9 | 5 | GEY | BEY |
| TV15C240J(B)-G | 24.0 | 26.7 | 29.5 | 1 | 200 | 38.9 | 38.6 | 5 | GEZ | BEZ |
| TV15C260K(B)-G | 26.0 | 28.9 | 35.3 | 1 | 200 | 46.6 | 32.2 | 5 | GFD | BFD |
| TV15C260J(B)-G | 26.0 | 28.9 | 31.9 | 1 | 200 | 42.1 | 35.6 | 5 | GFE | BFE |
| TV15C280K(B)-G | 28.0 | 31.1 | 38.0 | 1 | 200 | 50.0 | 30.0 | 5 | GFF | BFF |
| TV15C280J(B)-G | 28.0 | 31.1 | 34.4 | 1 | 200 | 45.4 | 33.0 | 5 | GFG | BFG |
| TV15C300K(B)-G | 30.0 | 33.3 | 40.7 | 1 | 200 | 53.5 | 28.0 | 5 | GFH | BFH |
| TV15C300J(B)-G | 30.0 | 33.3 | 36.8 | 1 | 200 | 48.4 | 31.0 | 5 | GFK | BFK |
| TV15C330K(B)-G | 33.0 | 36.7 | 44.9 | 1 | 200 | 59.0 | 25.2 | 5 | GFL | BFL |
| TV15C330J(B)-G | 33.0 | 36.7 | 40.6 | 1 | 200 | 53.3 | 28.1 | 5 | GFM | BFM |
| TV15C360K(B)-G | 36.0 | 40.0 | 48.9 | 1 | 200 | 64.3 | 23.3 | 5 | GFN | BFN |
| TV15C360J(B)-G | 36.0 | 40.0 | 44.2 | 1 | 200 | 58.1 | 25.8 | 5 | GFP | BFP |
| TV15C400K(B)-G | 40.0 | 44.4 | 54.3 | 1 | 200 | 71.4 | 21.0 | 5 | GFQ | BFQ |
| TV15C400J(B)-G | 40.0 | 44.4 | 49.1 | 1 | 200 | 64.5 | 23.2 | 5 | GFR | BFR |
| TV15C430K(B)-G | 43.0 | 47.8 | 58.4 | 1 | 200 | 76.7 | 19.6 | 5 | GFS | BFS |
| TV15C430J(B)-G | 43.0 | 47.8 | 52.8 | 1 | 200 | 69.4 | 21.6 | 5 | GFT | BFT |
| TV15C450K(B)-G | 45.0 | 50.0 | 61.1 | 1 | 200 | 80.3 | 18.7 | 5 | GFU | BFU |
| TV15C450J(B)-G | 45.0 | 50.0 | 55.3 | 1 | 200 | 72.7 | 20.6 | 5 | GFV | BFV |

Rev. A

SMD Transient Voltage Suppressor



Table 1. Specification

| Part No | Absolute Maximum Rating(Ta=25°C) | | | | | Electrical Characteristic(Ta=25°C) | | | | |
|----------------|----------------------------------|----------------------|----------------------|----------------|------------------|------------------------------------|---------------------|----------------------------------|---------------|-----|
| | V _{RWM} | V _{BR} Min. | V _{BR} Max. | I _T | I _{FSM} | Max V _C | I _{PP} (A) | I _R @V _{RWM} | Marking Code. | |
| | (V) | (V) | (V) | (mA) | (A)@8.3ms | (V) | | (uA) | UNI | BI |
| TV15C480K(B)-G | 48.0 | 53.3 | 65.1 | 1 | 200 | 76.7 | 17.5 | 5 | GFW | BFW |
| TV15C480J(B)-G | 48.0 | 53.3 | 58.9 | 1 | 200 | 69.4 | 21.6 | 5 | GFX | BFX |
| TV15C510K(B)-G | 51.0 | 56.7 | 69.3 | 1 | 200 | 80.3 | 18.7 | 5 | GFY | BFY |
| TV15C510J(B)-G | 51.0 | 56.7 | 62.7 | 1 | 200 | 72.7 | 20.6 | 5 | GFZ | BFZ |
| TV15C540K(B)-G | 54.0 | 60.0 | 73.3 | 1 | 200 | 85.5 | 15.6 | 5 | GGD | BGD |
| TV15C540J(B)-G | 54.0 | 60.0 | 66.3 | 1 | 200 | 77.4 | 17.2 | 5 | GGE | BGE |
| TV15C580K(B)-G | 58.0 | 64.4 | 78.7 | 1 | 200 | 91.1 | 14.6 | 5 | GGF | BGF |
| TV15C580J(B)-G | 58.0 | 64.4 | 71.2 | 1 | 200 | 82.4 | 16.0 | 5 | GGG | BGG |
| TV15C600K(B)-G | 60.0 | 66.7 | 81.5 | 1 | 200 | 96.3 | 14.0 | 5 | GGH | BGH |
| TV15C600J(B)-G | 60.0 | 66.7 | 73.7 | 1 | 200 | 87.1 | 15.5 | 5 | GGK | BGK |
| TV15C640K(B)-G | 64.0 | 71.1 | 86.9 | 1 | 200 | 103.0 | 13.2 | 5 | GGL | BGL |
| TV15C640J(B)-G | 64.0 | 71.1 | 78.6 | 1 | 200 | 93.6 | 14.6 | 5 | GGM | BGM |
| TV15C700K(B)-G | 70.0 | 77.8 | 95.1 | 1 | 200 | 107.0 | 12.0 | 5 | GGN | BGN |
| TV15C700J(B)-G | 70.0 | 77.8 | 86.0 | 1 | 200 | 96.8 | 13.3 | 5 | GGP | BGP |
| TV15C750K(B)-G | 75.0 | 83.3 | 102.0 | 1 | 200 | 114.0 | 11.2 | 5 | GGQ | BGQ |
| TV15C750J(B)-G | 75.0 | 83.3 | 92.1 | 1 | 200 | 103.0 | 12.4 | 5 | GGR | BGR |
| TV15C780K(B)-G | 78.0 | 86.7 | 106.0 | 1 | 200 | 139.0 | 10.8 | 5 | GGS | BGS |
| TV15C780J(B)-G | 78.0 | 86.7 | 95.8 | 1 | 200 | 126.0 | 11.4 | 5 | GGT | BGT |
| TV15C850K(B)-G | 85.0 | 94.4 | 115.0 | 1 | 200 | 151.0 | 9.9 | 5 | GGU | BGU |
| TV15C850J(B)-G | 85.0 | 94.4 | 104.0 | 1 | 200 | 137.0 | 10.4 | 5 | GGV | BGV |
| TV15C900K(B)-G | 90.0 | 100 | 122.0 | 1 | 200 | 160.0 | 9.4 | 5 | GGW | BGW |
| TV15C900J(B)-G | 90.0 | 100 | 111.0 | 1 | 200 | 146.0 | 10.3 | 5 | GGX | BGX |
| TV15C101K(B)-G | 100 | 111 | 136.0 | 1 | 200 | 179.0 | 8.4 | 5 | GGY | BGY |
| TV15C101J(B)-G | 100 | 111 | 123.0 | 1 | 200 | 162.0 | 9.3 | 5 | GGZ | BGZ |
| TV15C111K(B)-G | 110 | 122 | 149.0 | 1 | 200 | 196.0 | 7.7 | 5 | GHD | BHD |
| TV15C111J(B)-G | 110 | 122 | 135.0 | 1 | 200 | 177.0 | 8.4 | 5 | GHE | BHE |
| TV15C121K(B)-G | 120 | 133 | 163.0 | 1 | 200 | 214.0 | 7.0 | 5 | GHF | BHF |
| TV15C121J(B)-G | 120 | 133 | 147.0 | 1 | 200 | 193.0 | 7.9 | 5 | GHG | BHG |
| TV15C131K(B)-G | 130 | 144 | 176.0 | 1 | 200 | 231.0 | 6.5 | 5 | GHH | BHH |
| TV15C131J(B)-G | 130 | 144 | 159.0 | 1 | 200 | 209.0 | 7.2 | 5 | GHK | BHK |
| TV15C151K(B)-G | 150 | 167 | 204.0 | 1 | 200 | 268.0 | 5.6 | 5 | GHL | BHL |
| TV15C151J(B)-G | 150 | 167 | 185.0 | 1 | 200 | 243.0 | 6.2 | 5 | GHM | BHM |
| TV15C161K(B)-G | 160 | 178 | 218.0 | 1 | 200 | 287.0 | 5.2 | 5 | GHN | BHN |
| TV15C161J(B)-G | 160 | 178 | 197.0 | 1 | 200 | 259.0 | 5.8 | 5 | GHP | BHP |
| TV15C171K(B)-G | 170 | 189 | 231.0 | 1 | 200 | 304.0 | 4.9 | 5 | GHQ | BHQ |
| TV15C171J(B)-G | 170 | 189 | 209.0 | 1 | 200 | 275.0 | 5.5 | 5 | GHR | BHR |

Note:

- 1) Suffix K denotes 10% tolerance devices, suffix J denotes 5% tolerance devices.
- 2) Suffix B after part number to specify bi-directional devices.
- 3) For bi-directional devices having VR of 10 volts and under, the IR limit is double.