

IR Receiver Modules for Remote Control Systems

Description

The TSOP341.. - series are miniaturized receivers for infrared remote control systems. PIN diode and preamplifier are assembled on lead frame, the epoxy package is designed as IR filter.

The demodulated output signal can directly be decoded by a microprocessor. The main benefit is the operation with short burst transmission codes and high data rates at a supply voltage of 3 V.

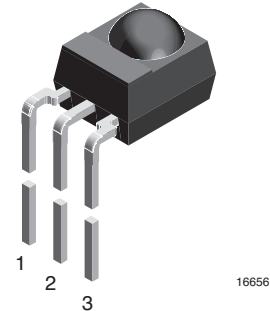

Features

- Photo detector and preamplifier in one package
- Internal filter for PCM frequency
- Improved shielding against electrical field disturbance
- TTL and CMOS compatibility
- Output active low
- Supply voltage range: 2.7 V to 5.5 V
- High immunity against ambient light



Mechanical Data

Pinning:

1 = OUT, 2 = GND, 3 = V_S

Parts Table

| Part | Carrier Frequency |
|--------------|-------------------|
| TSOP34130SB1 | 30 kHz |
| TSOP34133SB1 | 33 kHz |
| TSOP34136SB1 | 36 kHz |
| TSOP34137SB1 | 36.7 kHz |
| TSOP34138SB1 | 38 kHz |
| TSOP34140SB1 | 40 kHz |
| TSOP34156SB1 | 56 kHz |

Special Features

- Enhanced data rate up to 4000 bit/s
- Operation with short short bursts possible (≥ 6 cycles/burst)

Block Diagram

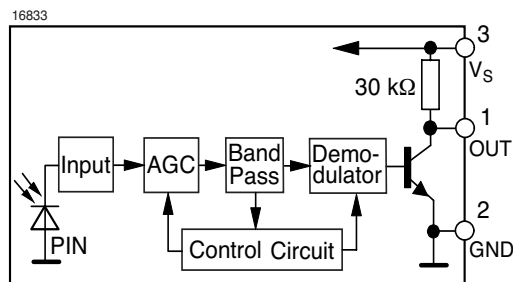

Application Circuit

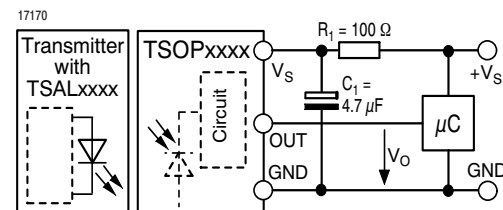

$R_1 + C_1$ recommended to suppress power supply disturbances.

The output voltage should not be hold continuously at a voltage below $V_O = 2.0$ V by the external circuit.

Absolute Maximum Ratings

Absolute Maximum Ratings

$T_{amb} = 25\text{ }^{\circ}\text{C}$, unless otherwise specified

| Parameter | Test condition | Symbol | Value | Unit |
|-----------------------------|---|-----------|-----------------------------|--------------------|
| Supply Voltage | (Pin 3) | V_S | - 0.3 to + 6.0 | V |
| Supply Current | (Pin 3) | I_S | 3 | mA |
| Output Voltage | (Pin 1) | V_O | - 0.3 to ($V_S + 0.3$) | V |
| Output Current | (Pin 1) | I_O | 10 | mA |
| Junction Temperature | | T_j | 100 | $^{\circ}\text{C}$ |
| Storage Temperature Range | | T_{stg} | - 25 to + 85 | $^{\circ}\text{C}$ |
| Operating Temperature Range | | T_{amb} | - 25 to + 85 | $^{\circ}\text{C}$ |
| Power Consumption | ($T_{amb} \leq 85\text{ }^{\circ}\text{C}$) | P_{tot} | 30 | mW |
| Soldering Temperature | $t \leq 10\text{ s}$, 1 mm from case | T_{sd} | 260 | $^{\circ}\text{C}$ |

Electrical and Optical Characteristics

$T_{amb} = 25\text{ }^{\circ}\text{C}$, unless otherwise specified

| Parameter | Test condition | Symbol | Min | Typ. | Max | Unit |
|----------------------------------|---|-----------------|-----|----------|-----|-----------------|
| Supply Current (Pin 3) | $E_v = 0$ | I_{SD} | 0.7 | 1.2 | 1.5 | mA |
| | $E_v = 40\text{ klx}$, sunlight | I_{SH} | | 1.3 | | mA |
| Supply Voltage | | V_S | 2.7 | | 5.5 | V |
| Transmission Distance | $E_v = 0$, test signal see fig.1, IR diode TSAL6200, $I_F = 250\text{ mA}$ | d | | 35 | | m |
| Output Voltage Low (Pin 1) | $I_{OSL} = 0.5\text{ mA}$, $E_e = 0.7\text{ mW/m}^2$, test signal see fig. 1 | V_{OSL} | | | 250 | mV |
| Minimum Irradiance (30 - 40 kHz) | $V_S = 3\text{ V}$ Pulse width tolerance: $t_{pi} - 5/f_o < t_{po} < t_{pi} + 6/f_o$, test signal see fig.3 | $E_{e\ min}$ | | 0.2 | 0.4 | mW/m^2 |
| Minimum Irradiance (56 kHz) | $V_S = 3\text{ V}$ Pulse width tolerance: $t_{pi} - 5/f_o < t_{po} < t_{pi} + 6/f_o$, test signal see fig.3 | $E_{e\ min}$ | | 0.3 | 0.5 | mW/m^2 |
| Minimum Irradiance (30 - 40 kHz) | $V_S = 5\text{ V}$ Pulse width tolerance: $t_{pi} - 5/f_o < t_{po} < t_{pi} + 6/f_o$, test signal see fig.3 | $E_{e\ min}$ | | 0.35 | 0.5 | mW/m^2 |
| Minimum Irradiance (56 kHz) | $V_S = 5\text{ V}$ Pulse width tolerance: $t_{pi} - 5/f_o < t_{po} < t_{pi} + 6/f_o$, test signal see fig.3 | $E_{e\ min}$ | | 0.45 | 0.6 | mW/m^2 |
| Maximum Irradiance | $t_{pi} - 5/f_o < t_{po} < t_{pi} + 6/f_o$, test signal see fig. 3 | $E_{e\ max}$ | 30 | | | W/m^2 |
| Directivity | Angle of half transmission distance | $\varphi_{1/2}$ | | ± 45 | | deg |

Typical Characteristics (Tamb = 25 °C unless otherwise specified)

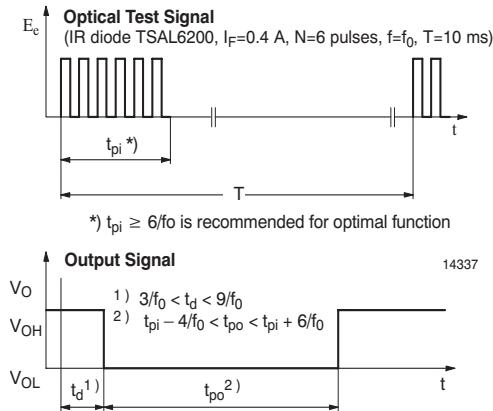

Figure 1. Output Function

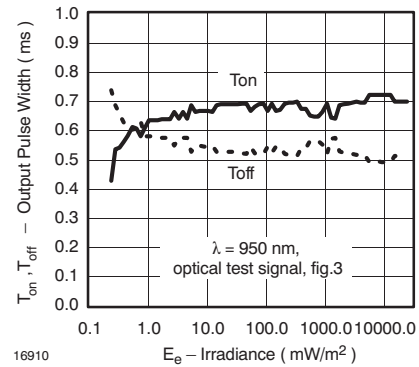

Figure 4. Output Pulse Diagram

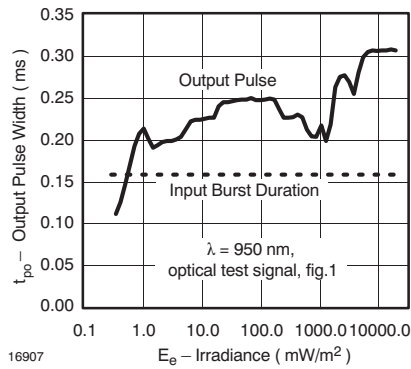

Figure 2. Pulse Length and Sensitivity in Dark Ambient

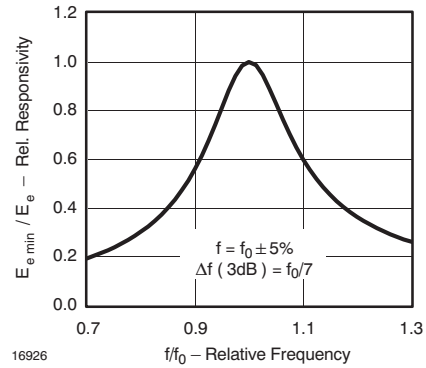

Figure 5. Frequency Dependence of Responsivity

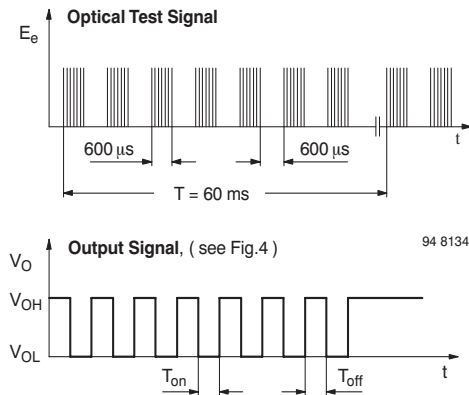

Figure 3. Output Function

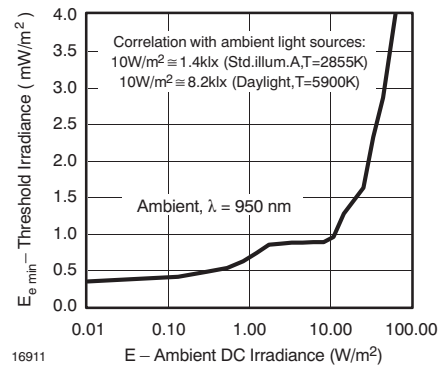

Figure 6. Sensitivity in Bright Ambient

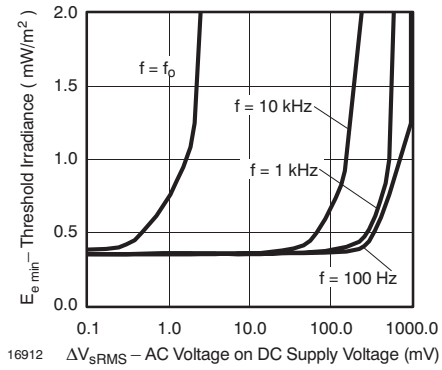

Figure 7. Sensitivity vs. Supply Voltage Disturbances

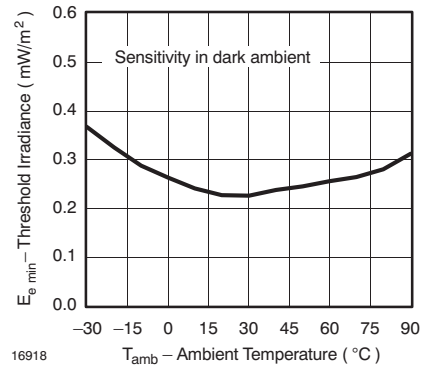

Figure 10. Sensitivity vs. Ambient Temperature

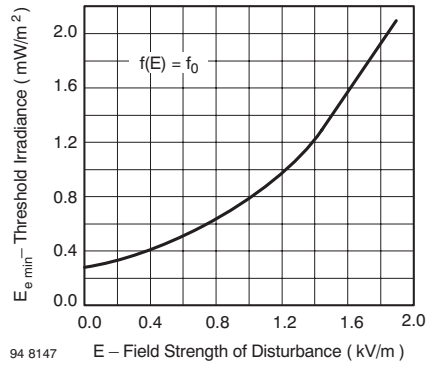

Figure 8. Sensitivity vs. Electric Field Disturbances

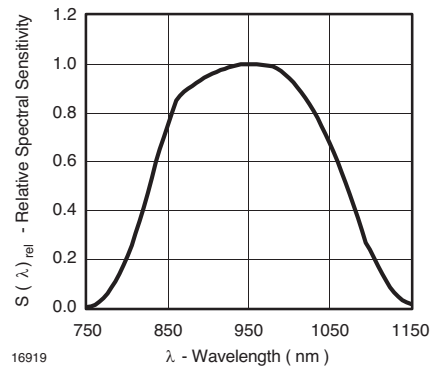

Figure 11. Relative Spectral Sensitivity vs. Wavelength

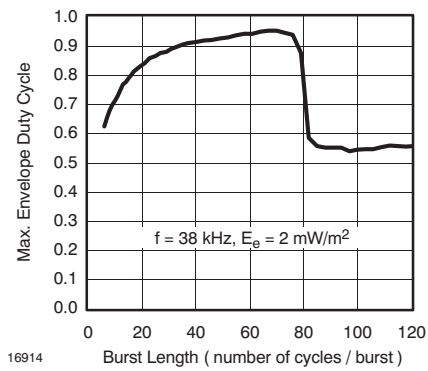

Figure 9. Max. Envelope Duty Cycle vs. Burstlength

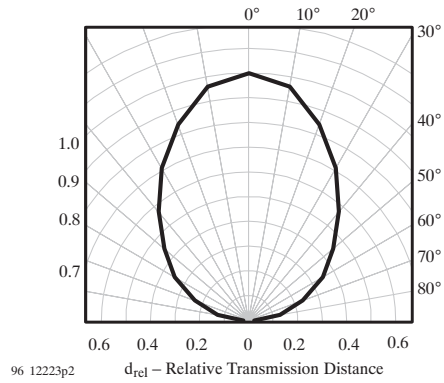

Figure 12. Directivity

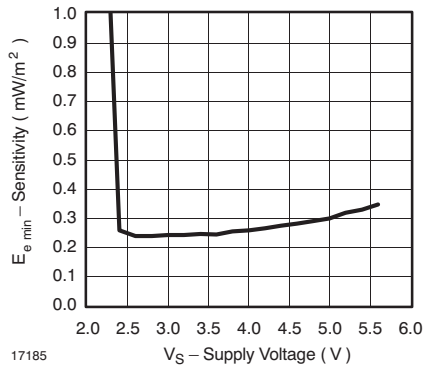

Figure 13. Sensitivity vs. Supply Voltage

Suitable Data Format

The circuit of the TSOP341.. is designed in that way that unexpected output pulses due to noise or disturbance signals are avoided. A bandpass filter, an integrator stage and an automatic gain control are used to suppress such disturbances.

The distinguishing mark between data signal and disturbance signal are carrier frequency, burst length and duty cycle.

The data signal should fulfill the following conditions:

- Carrier frequency should be close to center frequency of the bandpass (e.g. 38 kHz).
- Burst length should be 6 cycles/burst or longer.
- After each burst which is between 6 cycles and 70 cycles a gap time of at least 10 cycles is necessary.
- For each burst which is longer than 1.8 ms a corresponding gap time is necessary at some time in the data stream. This gap time should have at least same length as the burst.
- Up to 2200 short bursts per second can be received continuously.

Some examples for suitable data format are: NEC Code, Toshiba Micom Format, Sharp Code, RC5 Code, RC6 Code, RCMM Code, R-2000 Code, RECS-80 Code.

When a disturbance signal is applied to the TSOP341.. it can still receive the data signal. However the sensitivity is reduced to that level that no unexpected pulses will occur.

Some examples for such disturbance signals which are suppressed by the TSOP341.. are:

- DC light (e.g. from tungsten bulb or sunlight)

- Continuous signal at 38 kHz or at any other frequency
- Signals from fluorescent lamps with electronic ballast (an example of the signal modulation is in the figure below).

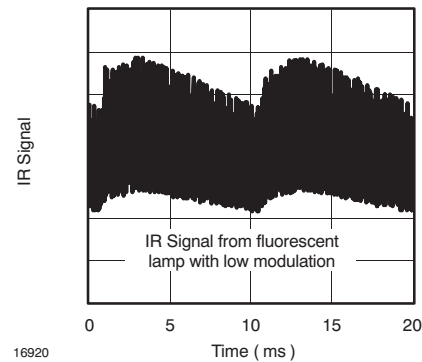

Figure 14. IR Signal from Fluorescent Lamp with low Modulation

TSOP341..SB1

Vishay Semiconductors



Package Dimensions in mm

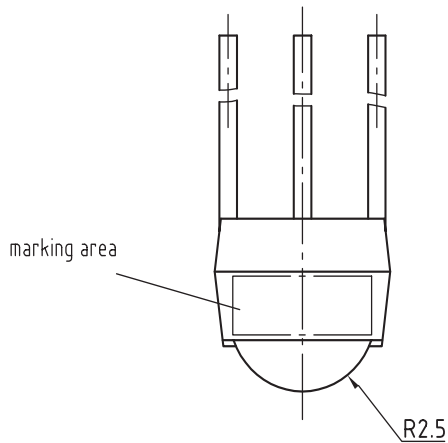
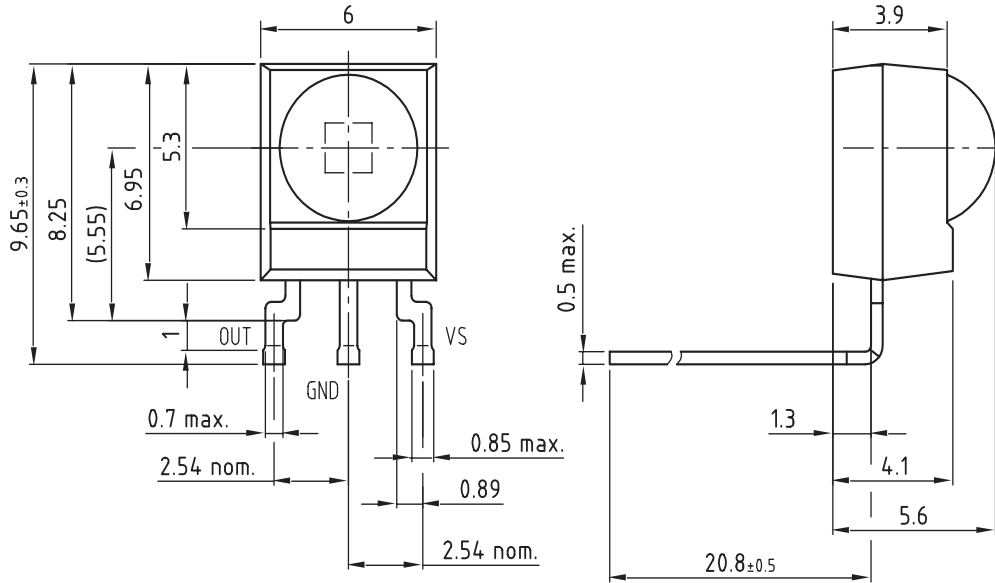

All dimensions in mm
Not indicated tolerances ±0.2

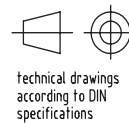

Drawing-No.: 6.550-5180.12-4
Issue: 3; 12.12.03

16777

Ozone Depleting Substances Policy Statement

It is the policy of Vishay Semiconductor GmbH to

1. Meet all present and future national and international statutory requirements.
2. Regularly and continuously improve the performance of our products, processes, distribution and operating systems with respect to their impact on the health and safety of our employees and the public, as well as their impact on the environment.

It is particular concern to control or eliminate releases of those substances into the atmosphere which are known as ozone depleting substances (ODSs).

The Montreal Protocol (1987) and its London Amendments (1990) intend to severely restrict the use of ODSs and forbid their use within the next ten years. Various national and international initiatives are pressing for an earlier ban on these substances.

Vishay Semiconductor GmbH has been able to use its policy of continuous improvements to eliminate the use of ODSs listed in the following documents.

1. Annex A, B and list of transitional substances of the Montreal Protocol and the London Amendments respectively
2. Class I and II ozone depleting substances in the Clean Air Act Amendments of 1990 by the Environmental Protection Agency (EPA) in the USA
3. Council Decision 88/540/EEC and 91/690/EEC Annex A, B and C (transitional substances) respectively.

Vishay Semiconductor GmbH can certify that our semiconductors are not manufactured with ozone depleting substances and do not contain such substances.

We reserve the right to make changes to improve technical design and may do so without further notice.

Parameters can vary in different applications. All operating parameters must be validated for each customer application by the customer. Should the buyer use Vishay Semiconductors products for any unintended or unauthorized application, the buyer shall indemnify Vishay Semiconductors against all claims, costs, damages, and expenses, arising out of, directly or indirectly, any claim of personal damage, injury or death associated with such unintended or unauthorized use.

Vishay Semiconductor GmbH, P.O.B. 3535, D-74025 Heilbronn, Germany
Telephone: 49 (0)7131 67 2831, Fax number: 49 (0)7131 67 2423



Notice

Specifications of the products displayed herein are subject to change without notice. Vishay Intertechnology, Inc., or anyone on its behalf, assumes no responsibility or liability for any errors or inaccuracies.

Information contained herein is intended to provide a product description only. No license, express or implied, by estoppel or otherwise, to any intellectual property rights is granted by this document. Except as provided in Vishay's terms and conditions of sale for such products, Vishay assumes no liability whatsoever, and disclaims any express or implied warranty, relating to sale and/or use of Vishay products including liability or warranties relating to fitness for a particular purpose, merchantability, or infringement of any patent, copyright, or other intellectual property right.

The products shown herein are not designed for use in medical, life-saving, or life-sustaining applications. Customers using or selling these products for use in such applications do so at their own risk and agree to fully indemnify Vishay for any damages resulting from such improper use or sale.