

TLV320AIC3104EVM and TLV320AIC3104EVM-PDK

This user's guide describes the characteristics, operation, and use of the TLV320AIC3104EVM, both by itself and as part of the TLV320AIC3104EVM-PDK. This evaluation module (EVM) is a complete stereo audio codec with several inputs and outputs, extensive audio routing, mixing, and effects capabilities. A complete circuit description, schematic diagram, and bill of materials are also included.

The following related documents are available through the Texas Instruments Web site at www.ti.com.

EVM-Compatible Device Data Sheets

Device	Literature Number
TLV320AIC3104	SLAS510
TAS1020B	SLES025
REG1117-3.3	SBVS001
TPS767D318	SLVS209
SN74LVC125A	SCAS290
SN74LVC1G125	SCES223
SN74LVC1G07	SCES296

Contents

1	EVM Overview	3
2	EVM Description and Basics	3
3	TLV320AIC3104EVM-PDK Setup and Installation	7
4	TLV320AIC3104EVM Software	9
Appendix A	EVM Connector Descriptions	37
Appendix B	TLV320AIC3104EVM Schematic	41
Appendix C	TLV320AIC3104EVM Layout Views	42
Appendix D	TLV320AIC3104EVM Bill of Materials	45
Appendix E	USB-MODEVM Schematic	46
Appendix F	USB-MODEVM Bill of Materials	47
Appendix G	USB-MODEVM Protocol	49

List of Figures

1	TLV320AIC3104EVM-PDK Block Diagram	4
2	Default Software Screen	8
3	Device Selection Window	9
4	Interface Selection Window	9
5	I ² C Address Selection Window	10
6	Default Configuration Tab	12
7	Audio Input Tab	13
8	Bypass Paths	14
9	Audio Interface Tab	15
10	Clocks Tab	17
11	GPIO Tab	19
12	AGC Tab	21

I²S, I²C are trademarks of Koninklijke Philips Electronics N.V.
Windows is a trademark of Microsoft Corporation.
SPI is a trademark of Motorola, Inc.
LabView is a trademark of National Instruments.

13	Left AGC Settings	22
14	Advanced	22
15	Filters Tab	23
16	ADC High Pass Filters	24
17	ADC High-Pass Filter Settings	24
18	DAC Filters	25
19	De-emphasis Filters	25
20	Enabling Filters	26
21	Shelf Filters	26
22	EQ Filters	27
23	Analog Simulation Filters	27
24	Preset Filters	28
25	User Filters	28
26	3D Effect Settings	29
27	Output Stage Configuration Tab	30
28	DAC/Line Outputs Tab	32
29	High-Power Outputs Tab	34
30	Command Line Interface Tab	35
31	File Menu	36
C-1	Assembly layer	42
C-2	Top Layer	42
C-3	Layer 3	43
C-4	Layer 4	43
C-5	Silk Screen	44
C-6	Bottom Layer	44

List of Tables

1	USB-MODEVM SW2 Settings	5
2	List of Jumpers	5
A-1	Analog Interface Pinout	37
A-2	Alternate Analog Connectors	38
A-3	Digital Interface Pinout	39
A-4	Power Supply Pinout	40
D-1	TLV320AIC3104EVM Bill of Materials	45
F-1	USB-MODEVM Bill of Materials	47
G-1	USB Control Endpoint HIDSETREPORT Request	49
G-2	Data Packet Configuration	49
G-3	GPIO Pin Assignments	52

1 EVM Overview

1.1 Features

- Full-featured evaluation board for the TLV320AIC3104 stereo audio codec.
- Modular design for use with a variety of digital signal processor (DSP) and microcontroller interface boards.
- USB connection to PC provides power, control, and streaming audio data for easy evaluation.
- Onboard microphone for ADC evaluation
- Connection points for external control and digital audio signals for quick connection to other circuits/input devices.

The TLV320AIC3104EVM-PDK is a complete evaluation kit, which includes a universal serial bus (USB)-based motherboard and evaluation software for use with a personal computer (PC) running the Microsoft Windows™ operating system (Win2000 or XP).

1.2 Introduction

The TLV320AIC3104EVM is in the Texas Instruments modular EVM form factor, which provides direct evaluation of the device performance and operating characteristics, and eases software development and system prototyping. This EVM is compatible with the 5-6K Interface Evaluation Module ([SLAU104](#)) and the HPA-MCUINTERFACE ([SLAU106](#)) from Texas Instruments and additional third-party boards which support the Texas Instrument modular EVM format.

The TLV320AIC3104EVM-PDK is a complete evaluation/demonstration kit, which includes a USB-based motherboard called the USB-MODEVM Interface board and evaluation software for use with a personal computer running the Microsoft Windows operating systems.

The TLV320AIC3104EVM-PDK is operational with one USB cable connection to a personal computer. The USB connection provides power, control, and streaming audio data to the EVM for reduced setup and configuration. The EVM also provides external control signals, audio data, and power for advanced operation, which allows prototyping and connection to the rest of the development or system evaluation.

2 EVM Description and Basics

This section provides information on the analog input and output, digital control, power and general connection of the TLV320AIC3104EVM.

2.1 TLV320AIC3104EVM-PDK Block Diagram

The TLV320AIC3104EVM-PDK consists of two separate circuit boards, the USB-MODEVM and the TLV320AIC3104EVM. The USB-MODEVM is built around a TAS1020B streaming audio USB controller with an 8051-based core. The motherboard features two positions for modular EVM, or one double-wide serial modular EVM may be installed. The TLV320AIC3104EVM is one of the double-wide modular EVM that is designed to work with the USB-MODEVM.

The simple diagram below ([Figure 1](#)) shows the how the TLV320AIC3104EVM is connected to the USB-MODEVM. The USB-MODEVM Interface board is intended to be used in USB mode, where control of the installed EVM is accomplished using the onboard USB controller device. Provision is made, however, for driving all the data buses (I²C, SPI™, I²S/AC97) externally. The source of these signals is controlled by SW2 on the USB-MODEVM. Refer to [Table 1](#) for details on the switch settings.

The USB-MODEVM has two EVM positions that allow for the connection of two small evaluation module or one larger evaluation module. The TLV320AIC3104EVM is designed to fit over both of the smaller evaluation module slots as shown below.

2.1.1 USB-MODEVM Interface Board

The simple diagram shown in Figure 1 shows only the basic features of the USB-MODEVM Interface board.

Because the TLV320AIC3104EVM is a double-wide modular EVM, it is installed with connections to both EVM positions, which connects the TLV320AIC3104 digital control interface to the I²C port realized using the TAS1020B, as well as the TAS1020B digital audio interface..

In the factory configuration, the board is ready to use with the TLV320AIC3104EVM. To view all the functions and configuration options available on the USB-MODEVM board, see the USB-MODEVM Interface Board schematic in Appendix E.

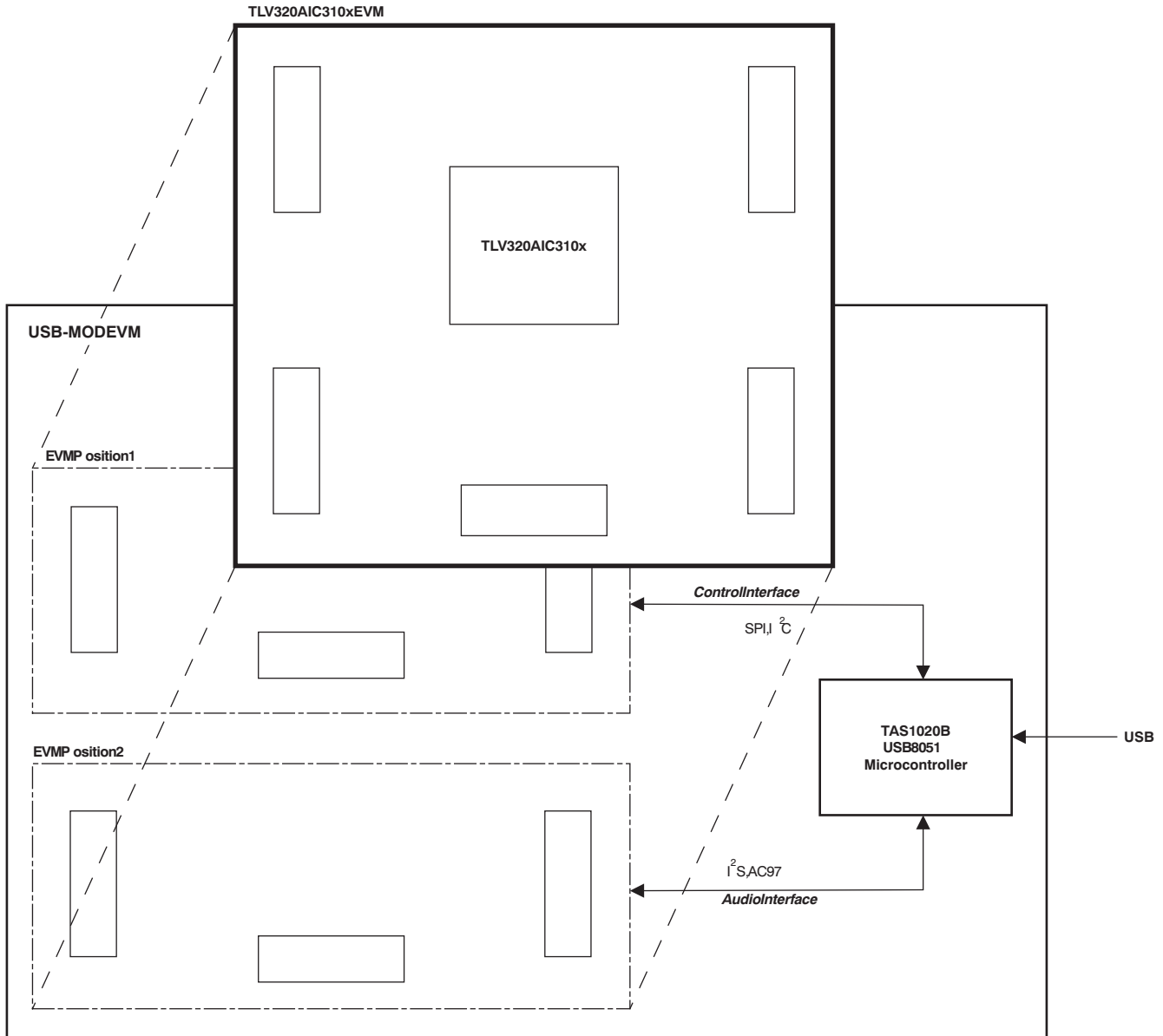

Figure 1. TLV320AIC3104EVM-PDK Block Diagram

2.2 Default Configuration and Connections

2.2.1 USB-MODEVM

Table 1 provides a list of the SW2 settings on the USB=MODEVM. For use with the TLV320AIC3104EVM, SW-2 positions 1 through 7 should be set to ON, while SW-2.8 should be set to OFF.

Table 1. USB-MODEVM SW2 Settings

SW-2 Switch Number	Label	Switch Description
1	A0	USB-MODEVM EEPROM I ² C Address A0 ON: A0 = 0 OFF: A0 = 1
2	A1	USB-MODEVM EEPROM I ² C Address A1 ON: A1 = 0 OFF: A1 = 1
3	A2	USB-MODEVM EEPROM I ² C Address A2 ON: A2 = 0 OFF: A2 = 1
4	USB I ² S	I ² S Bus Source Selection ON: I ² S Bus connects to TAS1020 OFF: I ² S Bus connects to USB-MODEVM J14
5	USB MCK	I ² S Bus MCLK Source Selection ON: MCLK connects to TAS1020 OFF: MCLK connects to USB-MODEVM J14
6	USB SPI	SPI Bus Source Selection ON: SPI Bus connects to TAS1020 OFF: SPI Bus connects to USB-MODEVM J15
7	USB RST	RST Source Selection ON: EVM Reset Signal comes from TAS1020 OFF: EVM Reset Signal comes from USB-MODEVM J15
8	EXT MCK	External MCLK Selection ON: MCLK Signal is provided from USB-MODEVM J10 OFF: MCLK Signal comes from either selection of SW2-5

2.2.2 TLV320AIC3104 Jumper Locations

Table 2 provides a list of jumpers found on the EVM and their factory default conditions.

Table 2. List of Jumpers

Jumper	Default Position	Jumper Description
JMP1	2-3	When connecting 2-3, mic bias comes from the MICBIAS pin on the device; when connecting 1-2, mic bias is supplied from the power supply through a resistor, which the user must install.
JMP2	Installed	Connects onboard Mic to Left Microphone Input.
JMP3	Installed	Connects onboard Mic to Right Microphone Input.
JMP4	Installed	Provides a means of measuring IOVDD current.
JMP5	Installed	Provides a means of measuring AVDD_ADC current.
JMP6	Installed	Provides a means of measuring DVDD current.
JMP7	Installed	Provides a means of measuring DRVDD current.
JMP8	Installed	Provides a means of measuring AVDD_DAC current.
JMP9	Installed	Connects Analog and Digital Grounds.
JMP10	3-5	When connecting 3 to 5, I ² C is selected as control mode; when connecting 1 to 3, SPI is selected as control mode. When connecting 3 to 4, mode selection can be made by a logic level at J16.12
JMP11	3-5	In I ² C control mode, this jumper sets the state of A0. When connecting 3 to 5, A0 = 0; when connecting 1 to 3, A0 = 1. In SPI control mode, connecting 3 to 4, SPI /SS is provided from J16.2
JMP12	3-5	In I ² C control mode, this jumper sets the state of A1. When connecting 3 to 5, A1 = 0; when connecting 1 to 3, A1 = 1. In SPI control mode, connecting 3 to 4, SPI SCLK is provided from J16.3
JMP13	Installed	When installed, shorts across the output capacitor on HPOUT; remove this jumper if using AC-coupled output drive

Table 2. List of Jumpers (continued)

Jumper	Default Position	Jumper Description
JMP14	Installed	When installed, shorts across the output capacitor on HPLCOM; remove this jumper if using AC-coupled output drive
JMP15	Installed	When installed, shorts across the output capacitor on HPROUT; remove this jumper if using AC-coupled output drive
JMP16	Installed	When installed, shorts HPLCOM and HPRCOM. Use only if these signals are set to constant VCM.
JMP17	Installed	When installed, shorts across the output capacitor on HPRCOM; remove this jumper if using AC-coupled output drive
JMP18	Open	Selects onboard EEPROM as Firmware Source.
JMP19	Open	When installed, allows the USB-MODEVM to hardware reset the device under user control

2.3 Analog Signal Connections

2.3.1 Analog Inputs

The analog inputs to the EVM can be connected through two different methods. The analog input sources can be applied directly to J13 (top or bottom side) or through the analog headers (J1-3 and J6) around the edge of the board. The connection details of each header/connector can be found in Appendix A.

2.3.2 Analog Output

The analog outputs to the EVM can be connected through two different methods. The analog outputs are available from the J13 and J14 (top or bottom) or they may be accessed through J4, J5, J7, J11, and J12 at the edges of the board. The connection details can be found in Appendix A.

2.4 Digital Signal Connections

2.4.1 Digital Inputs and Outputs

The digital inputs and outputs of the EVM can be monitored through J16 and J17. If external signals need to be connected to the EVM, digital inputs should be connected via J14 and J15 on the USB-MODEVM and the SW2 switch should be changed accordingly (see [Section 2.2.1](#)). The connector details are available in [Section A.2](#).

2.4.2 Digital Controls

The digital control signals can be applied directly to J16 and J17 (top or bottom side). The modular TLV320AIC3104EVM can also be connected directly to a DSP interface board, such as the 5-6KINTERFACE or HPA-MCUINTERFACE, or to the USB-MODEVM Interface board if purchased as part of the TLV320AIC3104EVM-PDK. See the product folders on the TI Web site for these evaluation modules or the TLV320AIC3104 for a current list of compatible interface and/or accessory boards.

2.5 Power Connections

The TLV320AIC3104EVM can be powered independently when being used in stand-alone operation or by the USB-MODEVM when it is plugged onto the motherboard.

2.5.1 Stand-Alone Operation

When used as a stand-alone EVM, power is applied to J15 directly, making sure to reference the supplies to the appropriate grounds on that connector.

CAUTION

Verify that all power supplies are within the safe operating limits shown on the [TLV320AIC3104](#) data sheet before applying power to the EVM.

J15 provides connection to the common power bus for the TLV320AIC3104EVM. Power is supplied on the pins listed in [Table A-4](#).

The TLV320AIC3104EVM-PDK motherboard (the USB-MODEVM Interface board) supplies power to J15 of the TLV320AIC3104EVM. Power for the motherboard is supplied either through its USB connection or via terminal blocks on that board.

2.5.2 USB-MODEVM Operation

The USB-MODEVM Interface board can be powered from several different sources:

- USB
- 6-Vdc to 10-Vdc AC/DC external wall supply (not included)
- Lab power supply

When powered from the USB connection, JMP6 should have a shunt from pins 1–2 (this is the default factory configuration). When powered from 6-V to 10-Vdc, either through the J8 terminal block or J9 barrel jack, JMP6 should have a shunt installed on pins 2–3. If power is applied in any of these ways, onboard regulators generate the required supply voltages and no further power supplies are necessary.

If laboratory supplies are used to provide the individual voltages required by the USB-MODEVM Interface, JMP6 should have no shunt installed. Voltages are then applied to J2 (+5 VA), J3 (+5 VD), J4 (+1.8 VD), and J5 (+3.3 VD). The +1.8 VD and +3.3 VD can also be generated on the board by the onboard regulators from the +5VD supply; to enable this configuration, the switches on SW1 need to be set to enable the regulators by placing them in the ON position (lower position, looking at the board with text reading right-side up). If +1.8 VD and +3.3 VD are supplied externally, disable the onboard regulators by placing SW1 switches in the OFF position.

Each power supply voltage has an LED (D1-D7) that lights when the power supplies are active.

3 TLV320AIC3104EVM-PDK Setup and Installation

The following section provides information on using the TLV320AIC3104EVM-PDK, including set up, program installation, and program usage.

Note: If using the EVM in stand-alone mode, the software should be installed per below, but the hardware configuration may be different.

3.1 Software Installation

1. Locate installation file on the CD-ROM included with the EVMs or download the latest version of the software located on the [AIC3104 Product Page](#). If downloading the software from the TI Web site, an option is available to allow the user to be notified when the software is updated.
2. Unzip the installation file by clicking on the self-extracting zip file.
3. Install the EVM software by double-clicking the **Setup** executable and follow the directions. The user may be prompted to restart their computer.

This should install all the TLV320AIC310x software and required drivers onto their PC.

3.2 EVM Connections

1. Ensure that the TLV320AIC3104EVM is installed on the USB-MODEVM Interface board, aligning J13, J14, J15, J16, and J17 with the corresponding connectors on the USB-MODEVM.
2. Verify that the jumpers and switches are in their default conditions.
3. Attach a USB cable from the PC to the USB-MODEVM Interface board. The default configuration will provide power, control signals, and streaming audio via the USB interface from the PC. On the USB-MODEVM, LEDs D3-6 should light to indicate the power is being supplied from the USB.
4. For the first connection, the PC should recognize new hardware and begin an initialization process. The user may be prompted to identify the location of the drivers or allow the PC to automatically search for them. Allow the automatic detection option.
5. Once the PC confirms that the hardware is operational, D2 on the USB-MODEVM should light to indicate that the firmware has been loaded and the EVM is ready for use. If the LED is not lite, verify that the drivers were installed and trying to unplug and restart at Step 3.

After the TLV320AIC3104EVM-PDK software installation (described in [Section 3.2](#)) is complete, evaluation and development with the TLV320AIC3104 can begin.

The TLV320AIC310xEVM software can now be launched. The user should see an initial screen that looks similar to [Figure 2](#).

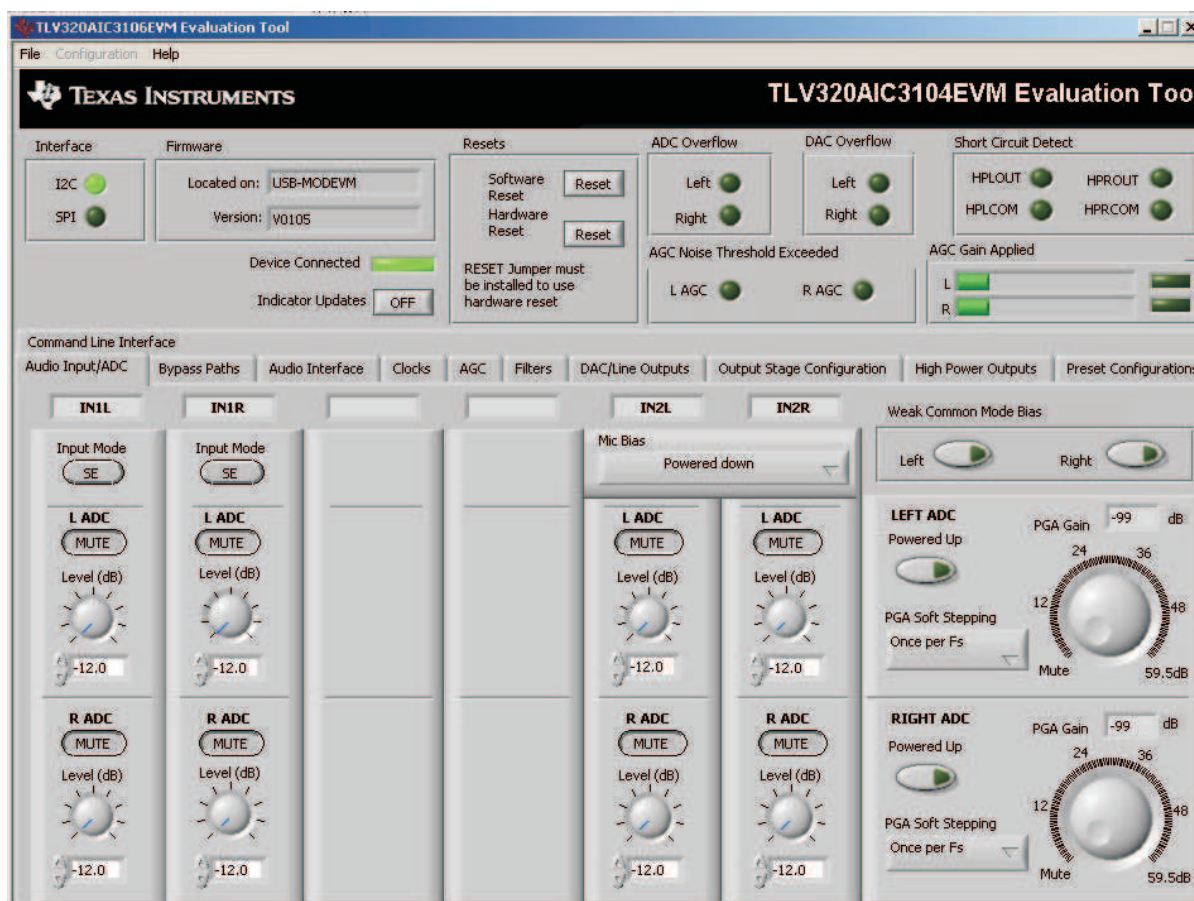

Figure 2. Default Software Screen

4 TLV320AIC3104EVM Software

The following section discusses the details and operation of the EVM software.

Note: For configuration of the codec, the TLV320AIC3104 block diagram located in the [TLV320AIC3104](#) data sheet is a good reference to help determine the signal routing.

4.1 Device Selection for Operation With AIC3104EVM

The software that is installed provides operation for several devices. An initial window should appear that looks like [Figure 3](#). For operation with the TLV320AIC3104EVM, the user should select *AIC3104* from the pull-down menu and click **Accept**. The software will take a few seconds to configure the software for operation before proceeding. A progress bar should appear and show the status of the configuration.

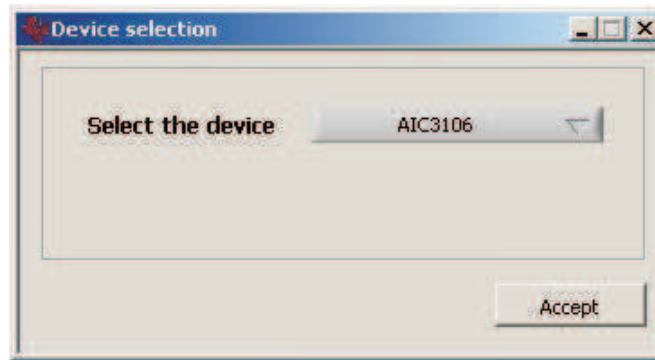

Figure 3. Device Selection Window

4.2 Interface Selection

When the program first starts up, a small window ([Figure 4](#)) appears that gives two choices for the control interface: IC or SPI. Click on the interface that will be used by the EVM, as selected by the jumper settings detailed in [Table 2](#). The setting of J10 should agree with the selection. ²C interface is the default interface used by the EVM.

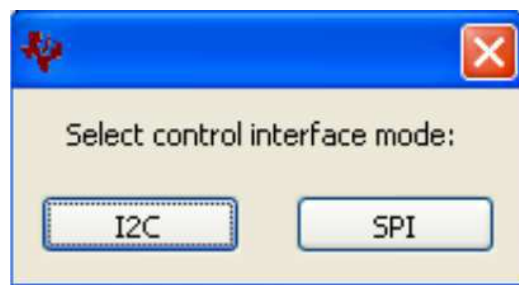

Figure 4. Interface Selection Window

If the I²C interface is selected, a second window then appears which allows for selecting the address of the TLV320AIC3104. This window (see [Figure 5](#)) has two sliders for setting the state of **A0** and **A1**. To allow proper communication with the EVM, these should match the settings of J11 and J12 ([Table 2](#)). When **A0** and **A1** are adjusted, the correct device address will be shown. Note that the actual I²C address shown and the address for the software may be different. This is done for programming reasons and the correct address should be used for system development.

If the I²C address is desired to be changed at any time during normal operation of the EVM, this menu can also be accessed from the pulldown menu under the *Configuration* item. This function can be used to help program multiple devices.

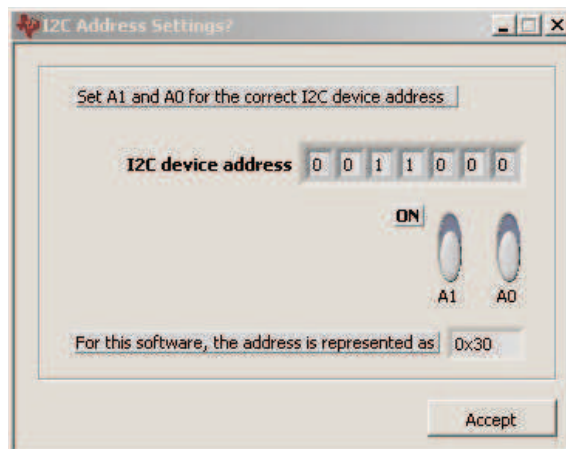

Figure 5. I²C Address Selection Window

Note: For operation of the EVM in the default status, no changes are required on this panel. The default settings are A1=A0=0. Changes to this panel are only required when operating the EVM with a specific I²C address (other than default) or when evaluating multiple EVM.

4.3 Front Page Indicators and Functions

Figure 2 illustrates the main screen of the EVM software. The indicators and buttons located above the tabbed section of the front page are visible regardless of which tab is currently being selected.

At the top left of the screen is an **Interface** indicator. This indicator shows which interface is selected for controlling the TLV320AIC3104, either I²C or SPI.

To the right of the Interface indicator is a group box called . This box indicates where the firmware being used is operating from—in this release, the firmware is on the USB-MODEVM, so the user should see *USB-MODEVM* in the box labeled **Located On:**. The version of the firmware appears in the **Version** box below this.

To the right, the next group box contains controls for resetting the TLV320AIC3104. A software reset can be done by writing to a register in the TLV320AIC3104, and this is accomplished by pushing the button labeled **Software Reset**. The TLV320AIC3104 also may be reset by toggling a pin on the TLV320AIC3104, which is done by pushing the **Hardware Reset** button.

CAUTION

In order to perform a hardware reset, the RESET jumper (JMP19) must be installed and SW2-7 on the USB-MODEVM must be turned OFF. Failure to do either of these steps results in not generating a hardware reset or causing unstable operation of the EVM, which may require cycling power to the USB-MODEVM.

Below the **Firmware** box, the **Device Connected** LED should be green when the EVM is connected. If the indicator is red, the EVM is not properly connected to the PC. Disconnect the EVM and verify that the drivers were correctly installed, then reconnect and try restarting the software.

On the upper right portion of the screen, several indicators are located which provide the status of various portions of the TLV320AIC3104. These indicators are activated by pressing the **Indicator Updates** button below the **Device Connected** LED. These indicators, as well as the other indicators on this panel, are updated only when the software's front panel is inactive, once every 20ms.

The **ADC Overflow** and **DAC Overflow** indicators light when the overflow flags are set in the TLV320AIC3104. Below these indicators are the **AGC Noise Threshold Exceeded** indicators that show when the AGC noise threshold is exceeded. To the far right of the screen, the **Short Circuit Detect** indicators show when a short-circuit condition is detected, if this feature has been enabled. Below the short-circuit indicators, the **AGC Gain Applied** indicators use a bar graph to show the amount of gain which has been applied by the AGC, and indicators that light when the AGC is saturated.

4.4 Default Configuration (Presets) Tab

The Default Configuration Tab [Figure 6](#) provides several different preset configurations of the codec. The **Preset Configurations** buttons allow the user to choose from the provided defaults. When the selection is made, the **Preset Configuration Description** shows a summary of the codec setup associated with the choice made. If the choice is acceptable, the **Load** button can be pressed and the preset configuration will be loaded into the codec. The user can change to the **Command Line Interface** Tab (see [Figure 30](#)) to view the actual settings that were programmed into the codec.

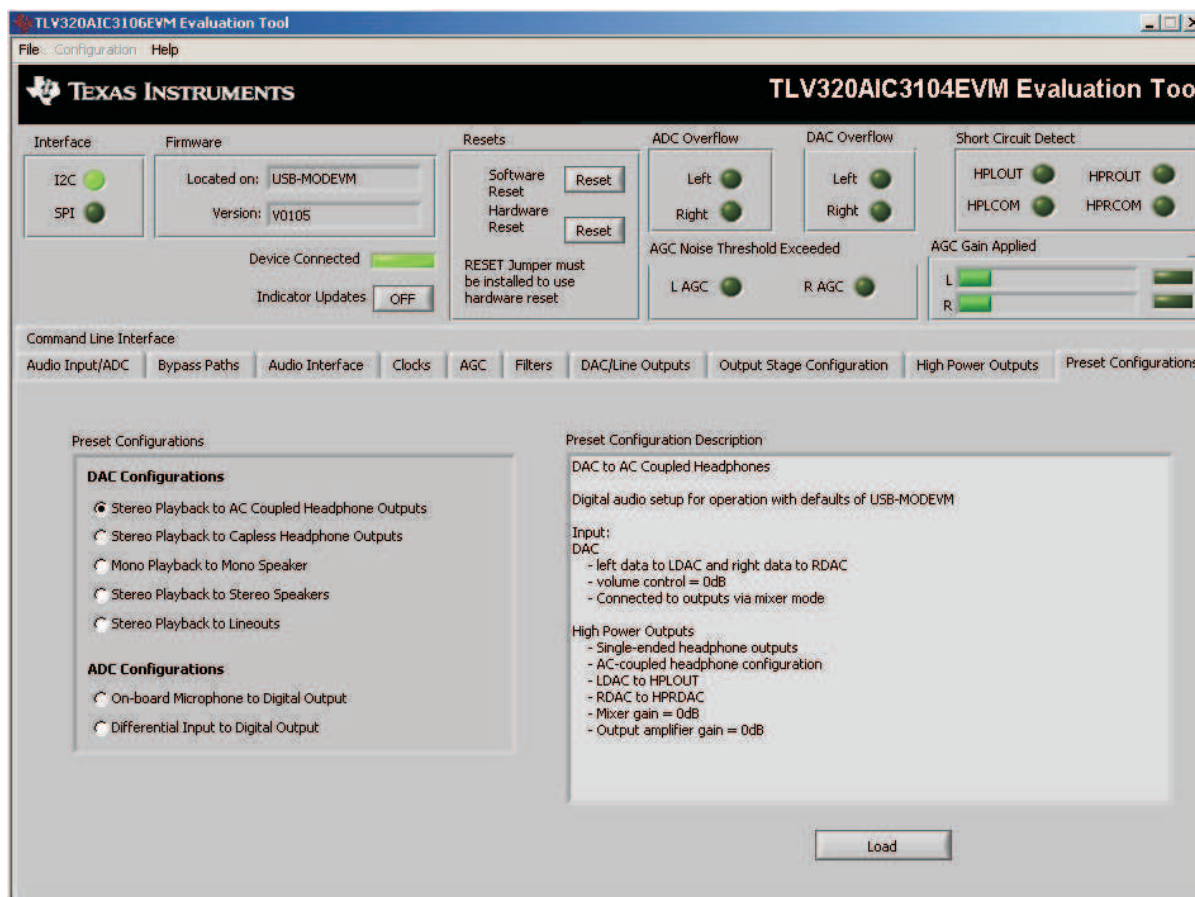

Figure 6. Default Configuration Tab

4.5 Audio Input/ADC Tab

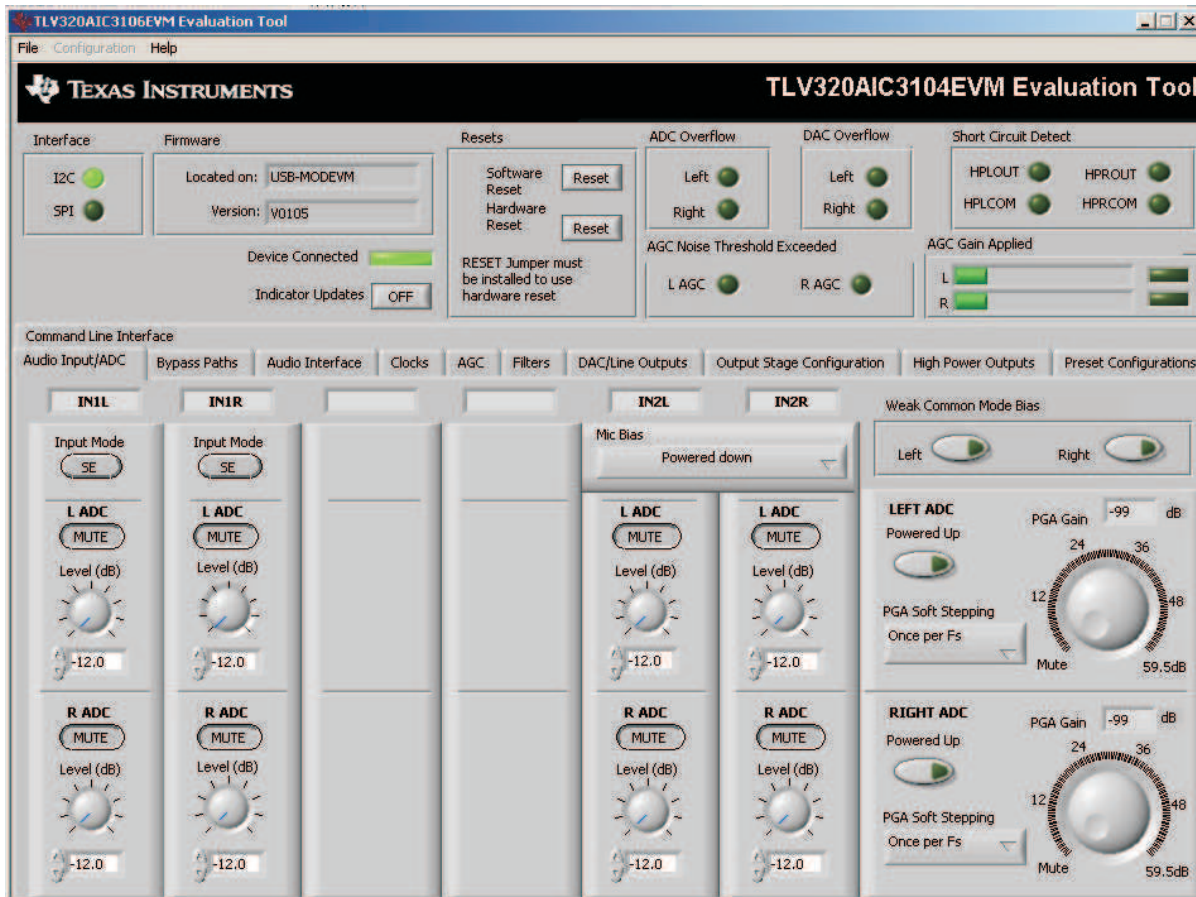

Figure 7. Audio Input Tab

The **Audio Input/ADC** Tab allows control of the analog input mixer and the ADC. The controls are displayed to look similar to an audio mixing console (see Figure 7). Each analog input channel has a vertical strip that corresponds to that channel. By default, all inputs are muted when the TLV320AIC3104 is powered up.

To route an analog input to the ADC:

1. Select the **Input Mode** button to correctly show if the input signal is single-ended (*SE*) or fully-differential (*Diff*). Inputs that are single-ended should be made to the positive signal terminal.
2. Click on the button of the analog input channel that corresponds to the correct ADC. The caption of the button should change to *Active*. Note that the user can connect some channels to both ADCs, while others will only connect to one ADC.
3. Adjust the **Level** control to the desired attenuation for the connected channel. This level adjustment can be done independently for each connection.

The TLV320AIC3104 offers a programmable microphone bias that can either be powered down or set to 2 V, 2.5 V, or the power supply voltage of the ADC ($AVDD_ADC$). Control of the microphone bias (mic bias) voltage is accomplished by using the **Mic Bias** pulldown menu button above the last two channel strips. To use the onboard microphone, JMP2 and JMP3 must be installed and nothing should be plugged into J6. In order for the mic bias settings in the software to take effect, JMP1 should be set to connect positions 2 and 3, so that mic bias is controlled by the TLV320AIC3104.

In the upper right portion of this tab are controls for **Weak Common Mode Bias**. Enabling these controls will result in unselected inputs to the ADC channels to be weakly biased to the ADC common mode voltage.

Below these controls are the controls for the ADC PGA, including the master volume controls for the ADC inputs. Each channel of the ADC can be powered up or down as needed using the **Powered Up** buttons. PGA soft-stepping for each channel is selected using the pulldown menu control. The two large knobs set the actual **ADC PGA Gain** and allow adjustment of the PGA gains from 0 dB to 59.5 dB in 0.5-dB steps (excluding Mute). At the extreme counterclockwise rotation, the channel is muted. Rotating the knob clockwise increases the PGA gain, which is displayed in the box directly above the volume control.

4.6 Bypass Paths

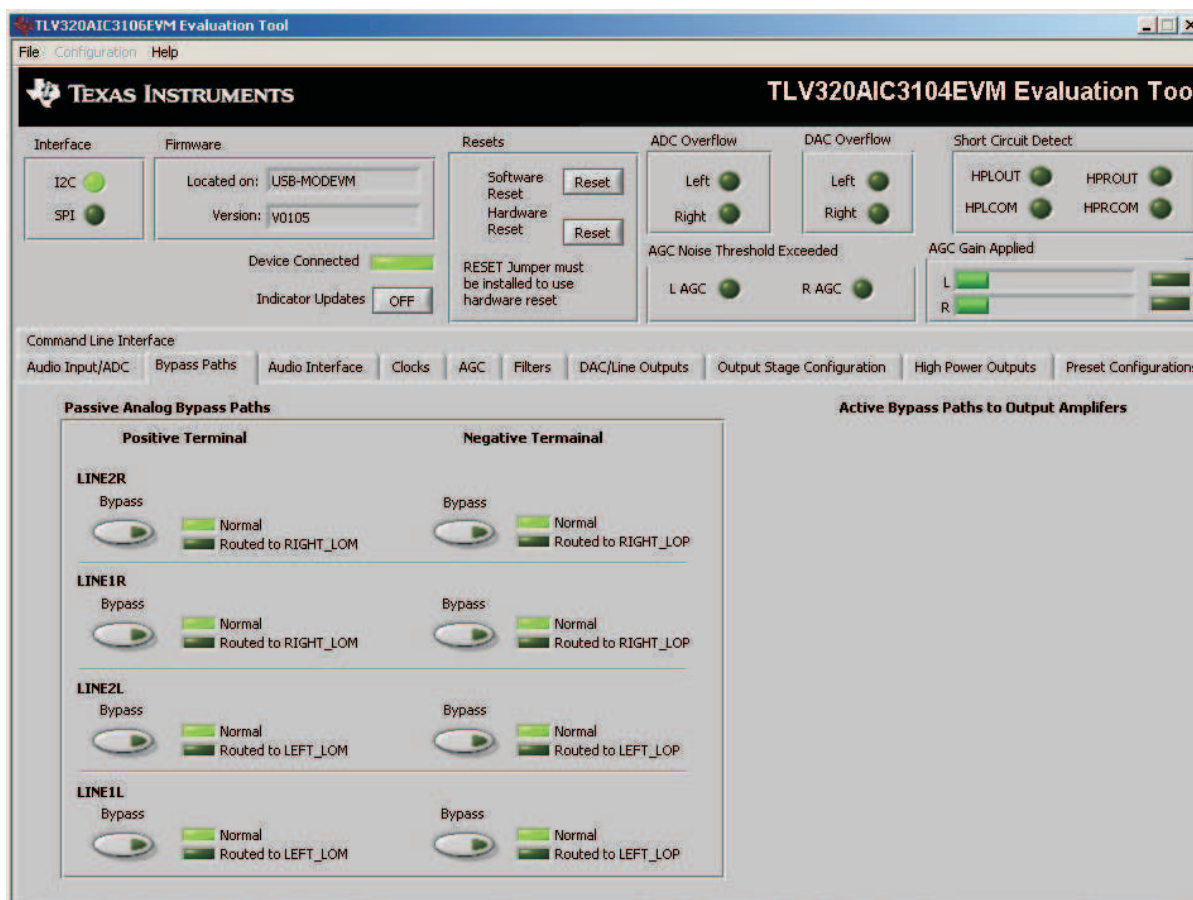

Figure 8. Bypass Paths

The **Bypass Paths** tab shows the active and passive bypass paths available for control.

The passive analog bypass paths allow the inputs to be routed straight through the device to the outputs without turning on any of the internal circuitry. This provides a signal path through the device with minimal power consumption.

The active bypass paths allow the inputs to bypass the ADC and DAC functional blocks and be routed to the analog output mixers to be summed into the output amplifiers.

4.7 Audio Interface Tab

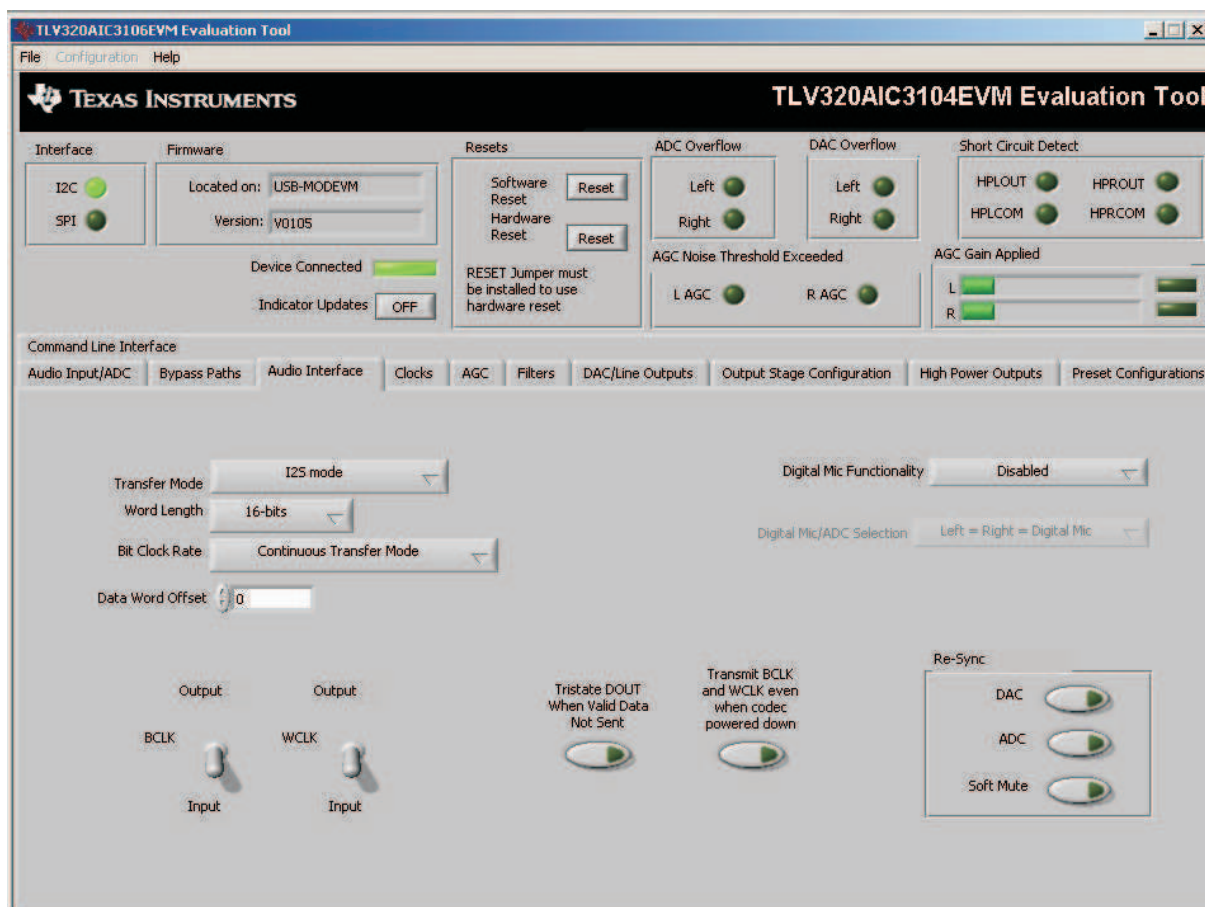

Figure 9. Audio Interface Tab

The Audio Interface tab (Figure 9) allows configuration of the audio digital data interface to the TLV320AIC3104.

The interface mode may be selected using the **Transfer Mode** control—selecting either I²S mode, DSP mode, or Right- or Left-Justified modes. Word length can be selected using the **Word Length** control, and the bit clock rate can also be selected using the **Bit Clock** rate control. The **Data Word Offset**, used in TDM mode (see the [TLV320AIC3104](#) data sheet) can also be selected on this tab.

Along the bottom of this tab are controls for choosing the **BLCK** and **WCLK** as being either inputs or outputs. With the codec configured in *Slave* mode, both the BCLK and WCLK are set to inputs. If the codec is in *Master* mode, then BCLK and WCLK are configured as outputs. Additionally, two buttons provide the option for placing the DOUT line in a 3-state mode when there is not valid data and transmitting BLCK and WCLK when the codec is powered down.

Re-synchronization of the audio bus is enabled using the controls in the lower right corner of this screen. Re-synchronization is done if the group delay changes by more than $\pm FS/4$ for the ADC or DAC sample rates (see the [TLV320AIC3104](#) data sheet). The channels can be soft muted when doing the re-sync if the **Soft Mute** button is enabled.

In the upper right corner of this tab is the **Digital Mic Functionality** control. The TLV320AIC3104 can accept a data stream from a digital microphone, which would have its clock pin connected to the TLV320AIC3104 GPIO1 pin, and the mic data connected to the GPIO2 pin. Once the digital microphone functionality is enabled, the **Digital Mic/ADC Selection** selection allows the user to choose if one or two digital microphones are connected to the codec. If only one digital microphone is connected, then the remaining ADC can be used with an analog input signal from the analog input pins. Refer to section

[Section 4.9](#) for a discussion of setting the GPIO pin options. The TLV320AIC3104 can provide a modulator clock to the digital microphone with oversampling ratios (OSR) of 128, 64, or 32. For a detailed discussion of how to connect a digital microphone on this platform, refer to the application note *Using the Digital Microphone Function on TLV320AIC3104 with AIC33EVM/USB-MODEVM System* ([SLAA275](#)), available for download at www.ti.com.

The default mode for the EVM is configured as 44.1 kHz, 16-bit, I² words, and the codec is a slave (BCLK and WCLK are supplied to the codec externally). For use with the PC software and the USB-MODEVM, the default settings should be used; no change to the software are required.

4.8 Clocks Tab

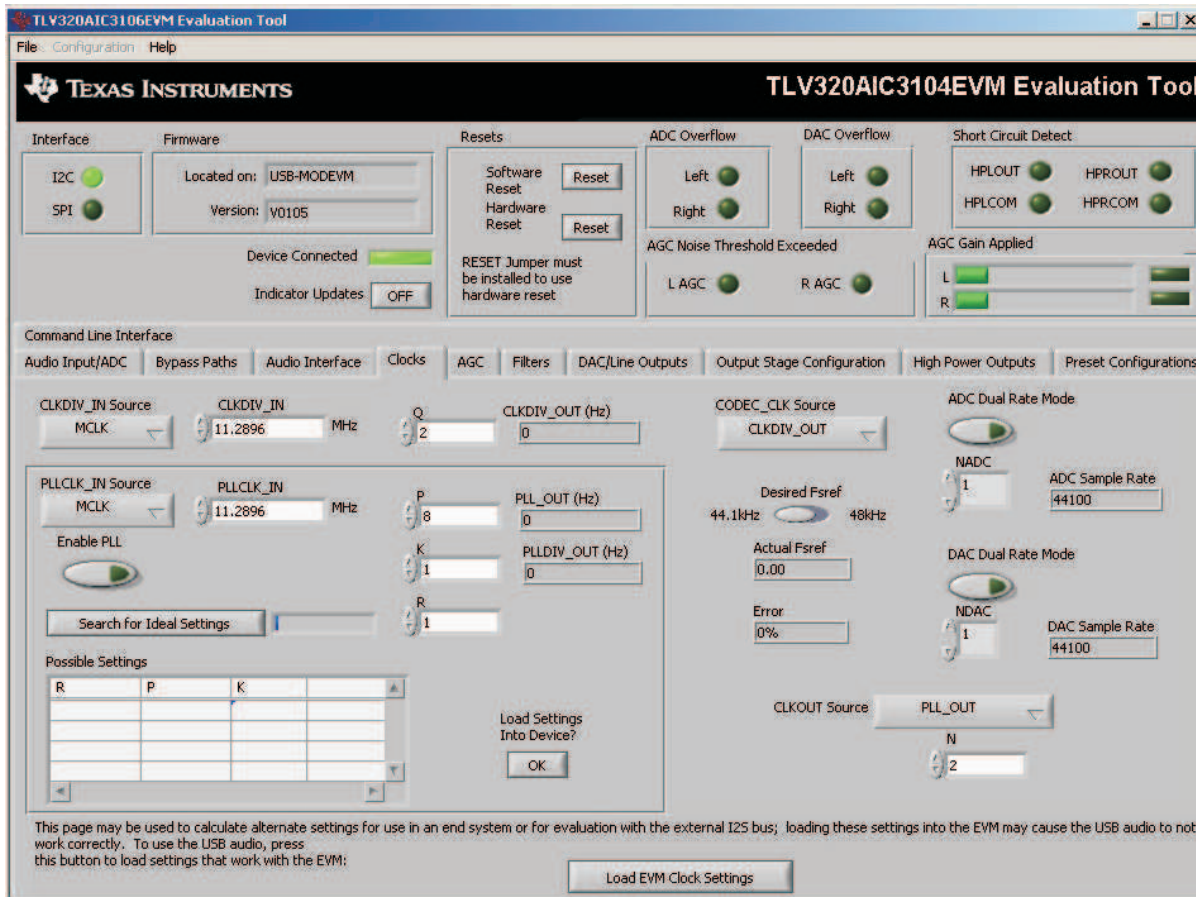

Figure 10. Clocks Tab

The TLV320AIC3104 provides a phase-locked loop (PLL) that allows flexibility in the clock generation for the ADC and DAC sample rates. The Clocks tab contains the controls that can be used to configure the TLV320AIC3104 for operation with a wide range of master clocks. See the Audio Clock Generation Processing figure in the [TLV320AIC3104](#) data sheet for further details of selecting the correct clock settings.

For use with the PC software and the USB-MODEVM, the clock settings must be set a certain way. If the settings are changed from the default settings which allow operation from the USB-MODEVM clock reference, the EVM settings can be restored automatically by pushing the **Load EVMS Clock Settings** button at the bottom of this tab. Note that changing any of the clock settings from the values loaded when this button is pushed may result in the EVM not working properly with the PC software or USB interface. If an external audio bus is used (audio not driven over the USB bus), then settings may be changed to any valid combination. See [Figure 10](#).

4.8.1 Configuring the codec clocks and Fsref calculation

The codec clock source is chosen by the **CODEC_CLK Source** control. When this control is set to *CLKDIV_OUT*, the PLL is not used; when set to *PLLDIV_OUT*, the PLL is used to generate the clocks.

Note: Per the [TLV320AIC3104](#) data sheet, the codec should be configured to allow the value of Fsref to fall between the values of 39 kHz to 53 kHz.

4.8.1.1 Use Without PLL

Setting up the TLV320AIC3104 for clocking without using the PLL permits the lowest power consumption by the codec. The **CLKDIV_IN** source can be selected as either *MCLK*, *GPIO2*, or *BCLK*, the default is *MCLK*. The **CLKDIV_IN** frequency is then entered into the **CLKDIV_IN** box, in megahertz (MHz). The default value shown, 11.2896 MHz, is the frequency used on the USB-MODEVM board. This value is then divided by the value of **Q**, which can be set from 2 to 17; the resulting **CLKDIV_OUT** frequency is shown in the indicator next to the **Q** control. The result frequency is shown as the *Actual Fsref*.

4.8.1.2 Use With The PLL

When **PLLDIV_OUT** is selected as the codec clock source, the PLL will be used. The PLL clock source is chosen using the **PLLCLK_IN** control, and may be set to either *MCLK*, *GPIO2*, or *BCLK*. The **PLLCLK_IN** frequency is then entered into the **PLLCLK_IN Source** box.

The **PLL_OUT** and **PLLDIV_OUT** indicators show the resulting PLL output frequencies with the values set for the **P**, **K**, and **R** parameters of the PLL. See the [TLV320AIC3104](#) data sheet for an explanation of these parameters. The parameters can be set by clicking on the up/down arrows of the **P**, **K**, and **R** combo boxes, or they can be typed into these boxes.

The values can also be calculated by the PC software. To use the PC software to find the ideal values of **P**, **K**, and **R** for a given PLL input frequency and desired **Fsref**:

1. Verify the correct reference frequency is entered into the **PLLCLK_IN Source** box in megahertz (MHz)
2. The desired **Fsref** should be set using the **Fsref** switch.
3. Push the **Search for Ideal Settings** button. The software will start searching for ideal combinations of **P**, **K**, and **R** which achieve the desired **Fsref**. The possible settings for these parameters are displayed in the spreadsheet-like table labeled *Possible Settings*.
4. Click on a row in this table to select the **P**, **K**, and **R** values located in that row. Notice that when this is done, the software updates the **P**, **K**, **R**, **PLL_OUT**, and **PLLDIV_OUT** readings, as well as the *Actual Fsref* and **Error** displays. The values show the calculations based on the values that were selected. This process does not actually load the values into the TLV320AIC3104, however; it only updates the displays in the software. If more than one row exists, the user can choose the other rows to see which of the possible settings comes closest to the ideal settings.

When a suitable combination of **P**, **K**, and **R** have been chosen, pressing the **Load Settings into Device?** button will download these values into the appropriate registers on the TLV320AIC3104.

4.8.1.3 Setting the ADC and DAC Sampling Rates

The **Fsref** frequency that is determine either enabling or bypassing the PLL (see [Section 4.8.1.1](#) or [Section 4.8.1.2](#)) is used to determine the actual ADC and DAC sampling rates. Using the **NADC** and **NDAC** factors the sampling rates are derived from the **Fsref**. If dual rate mode is desired, this option can be enabled for either the ADC or DAC by pressing the corresponding **Dual Rate Mode** button. The ADC and DAC sampling rates are shown in the box to the right of each control.

4.9 GPIO Tab

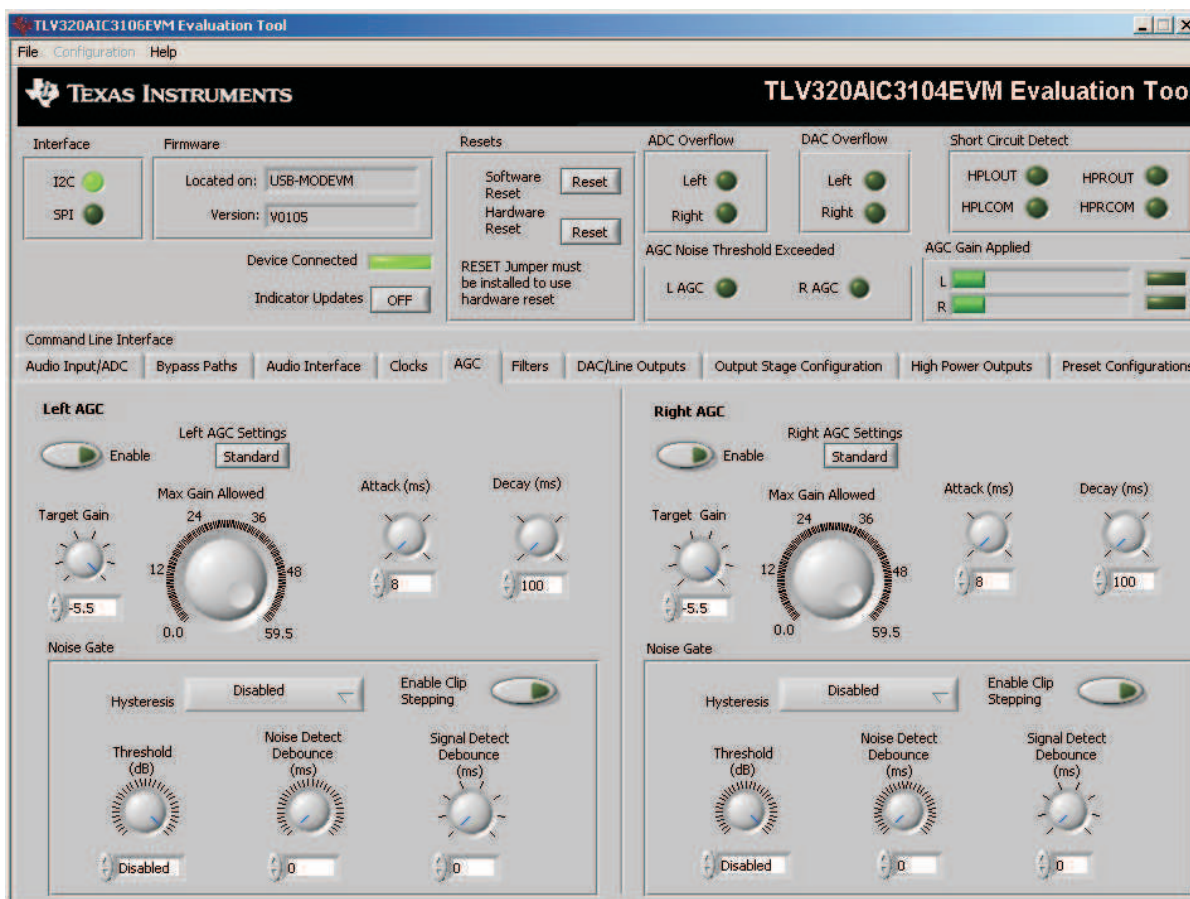

Figure 11. GPIO Tab

The GPIO tab (see Figure 11) selects options for the general-purpose inputs and outputs (GPIO) of the TLV320AIC3104. Many pins on the TLV320AIC3104 are denoted as *multifunction* pins, meaning they may be used for many different purposes.

The **GPIO1** group box contains controls for setting options for the GPIO1 pin. The **Function** control selects the function of GPIO1 from the following:

- ADC Word Clock
- An output clock derived from the reference clock (see [TLV320AIC3104](#) data sheet)
- Interrupt output pin to signal:
 - Short Circuit
 - AGC Noise Threshold detection
 - Jack/Headset detection
 - For use as an interrupt output, the behavior of the interrupt can be selected using the **Interrupt Duration** control. A *Single, 2ms* pulse can be delivered when the selected interrupt occurs, or *Continuous Pulses* can be generated signaling the interrupt.
- Alternate I²S Word Clock
- A digital microphone output–modulator clock for use with a digital microphone (see [Section 4.7](#) and the [TLV320AIC3104](#) data sheet).
- A general-purpose I/O pin
 - If selected as a *General Purpose Input*, the state of the GPIO1 pin is reflected by the **Input Level** indicator. If selected as a *General Purpose Output*, the state of the GPIO1 pin can be set by using the **Output Level** button.

In similar fashion, the GPIO2 pin can be configured as the following using the **Function** control in the **GPIO2** group box.

- An alternate I²S bus
- An interrupt output
- A general-purpose I/O pin
- A digital microphone input

The other controls in this group box work the same as the corresponding controls for GPIO1.

When the control interface for the TLV320AIC3104 is selected to be I²C, the **SDA** and **SCL** group boxes and controls within them are disabled. If SPI mode is selected, however, the SDA and SCL pins can be used as GPIO, and selected as either inputs or outputs using the **SDA Function** and **SCL Function** controls. The **Output Level** and **Input Level** controls function for these pins in the same way that they do for GPIO1 or GPIO2.

When the control interface for the TLV320AIC3104 is selected to be SPI, the **Multifunction Pins** group box and controls within it are disabled, because these pins are used by the SPI bus. When in I²C mode, however, these controls are enabled. The **MFP3 Function** control selects MFP3 to be used either as a *General Purpose Input* or as the data input line for the alternate I²S bus. The **MFP2 Function** control selects MFP2 as either *Disabled* or as a *General Purpose Output*. When used as an output, the **MFP2 Output Level** control sets the output state of the MFP2 pin either high or low. The states of the MFP0, MFP1 and MFP3 inputs are indicated by the three indicator lights on the right-hand side of this group box.

4.10 AGC Tab



Figure 12. AGC Tab

The AGC tab (see [Figure 12](#)) consists of two identical sets of controls, one for the left channel and the other for the right channel. The AGC function is described in the [TLV320AIC3104](#) data sheet.

The AGC can be enabled for each channel using the **Enable AGC** button. **Target** gain, **Attack** time in milliseconds, **Decay** time in milliseconds, and the **Maximum PGA Gain Allowed** can all be set, respectively, using the four corresponding knobs in each channel.

The TLV320AIC3104 allows for the Attack and Decay times of the AGC to be set up in two different modes, standard and advanced. The **Left/Right AGC Settings** button determines the mode selection. The *Standard* mode provides several preset times that can be selected by adjustments made to the **Attack** and **Decay** knobs. If finer control over the times is required, then the *Advanced* mode is selected to change to the settings. When the *Advanced* mode is enabled, two tabs should appear that allow separate, advanced control of the Attack and Delay times of the AGC (see [Figure 13](#) and [Figure 14](#)). These options allow selection of the base time as well as a multiplier to achieve the actual times shown in the corresponding text box. The **Use advanced settings?** button should be enabled to program the registers with the correct values selected via the pulldown options for base time and multiplier.



Figure 13. Left AGC Settings

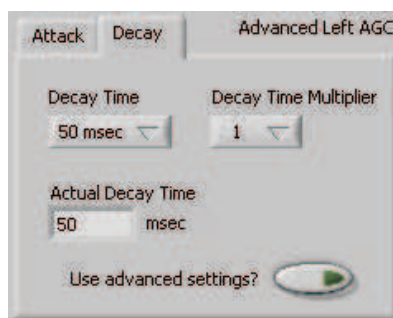

Figure 14. Advanced

Noise gate functions, such as **Hysteresis**, **Enable Clip stepping**, **Threshold (dB)**, **Signal Detect Debounce (ms)**, and **Noise Detect Debounce (ms)** are set using the corresponding controls in the **Noise Gate** group box for each channel.

4.11 Filters Tab

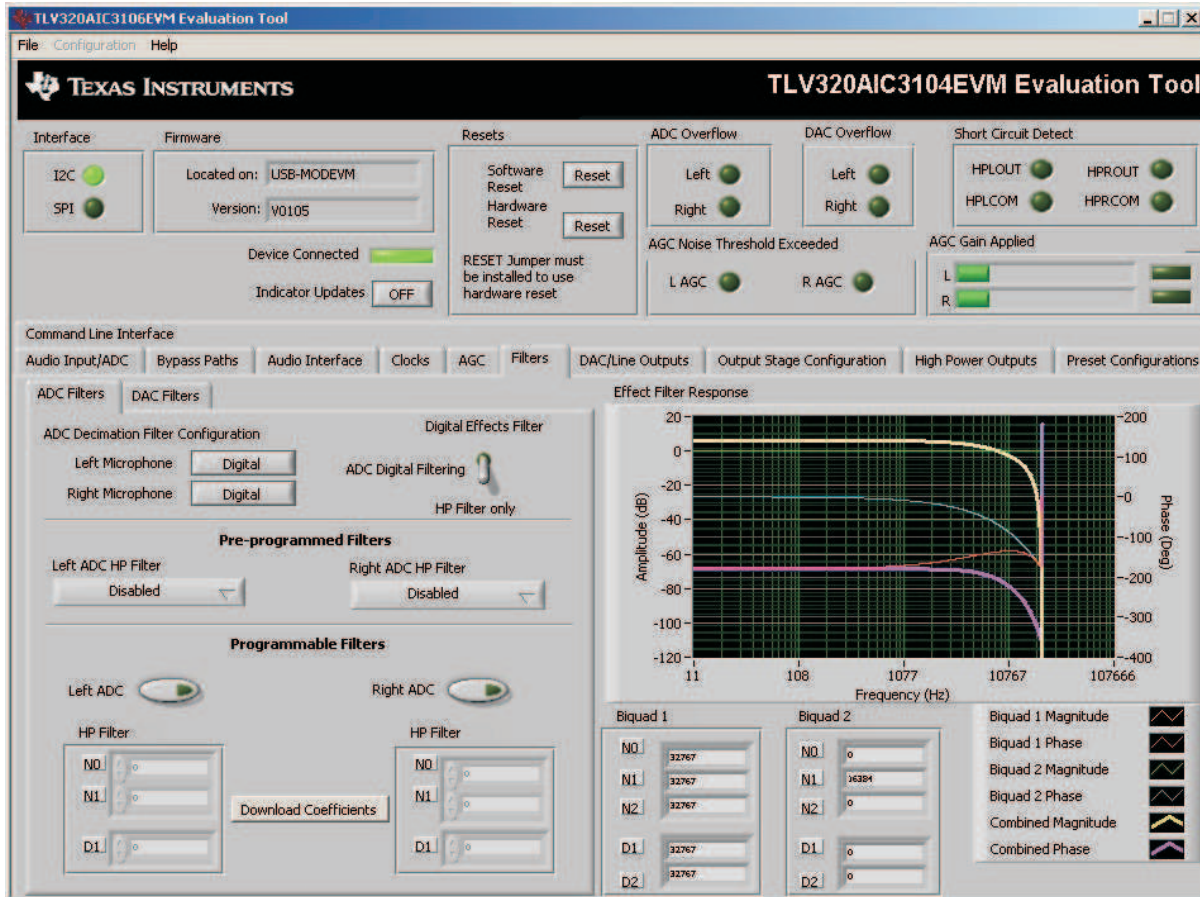

Figure 15. Filters Tab

The TLV320AIC3104 has an advanced feature set for applying digital filtering to audio signals. This tab controls all of the filter features of the TLV320AIC3104. In order to use this tab and have plotting of filter responses correct, the DAC sample rate must be set correctly. Therefore, the clocks must be set up correctly in the software following the discussion in [Section 4.8](#). See [Figure 15](#).

The AIC3104 digital filtering is available to both the ADC and DAC. The ADC has optional high pass filtering and allows the digital output from the ADC through digital effects filtering before exiting the codec through the PCM interface. Likewise, the digital audio data can be routed through the digital effects filtering before passing through the optional de-emphasis filter before the DAC. The digital effects filtering can only be connected to either the ADC or DAC, not both at the same time.

The [Figure 15](#) is divided into several areas. The left side of the tab, is used to select between the DAC or ADC filters and assist in the selection and calculating the desired filter coefficients. The right hand side of the tab shows a frequency response plot of the digital effects filter selected and the coefficients that are programmed into the device. The plots show the magnitude and phase response of each biquad section, plus the combined responses of the two biquad filters. Note that the plot shows only the responses of the effect filters, not the combined response of those filter along with the de-emphasis and ADC high-pass filters.

4.11.1 ADC Filters

4.11.1.1 High Pass Filter

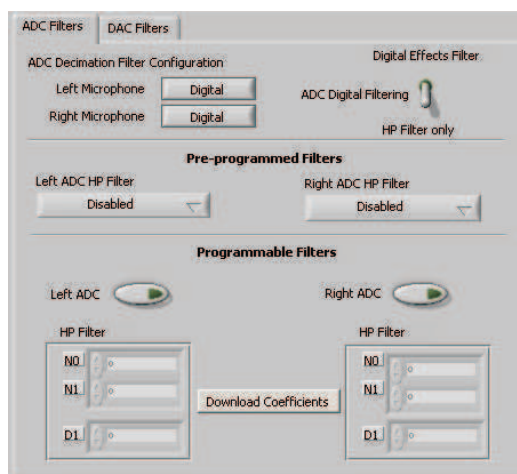

Figure 16. ADC High Pass Filters

The TLV320AIC3104 ADC provides the option of enabling a high-pass filter, which helps to reduce the effects of DC offsets in the system. The [Figure 16](#) tab shows the options for programming various filter associated with the ADC. The high-pass filter has two modes: standard and programmable.

The standard high-pass filter option ([Figure 17](#)) allows for the selection of the high-pass filter frequency from several preset options that can be chosen with the **Left ADC HP Filter** and **Right ADC HP Filter** controls. The four options for this setting are disabled, or three different corner frequencies which are based on the ADC sample rate.

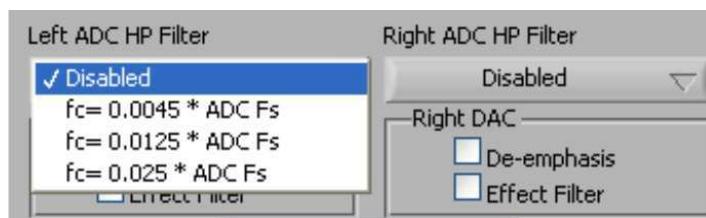

Figure 17. ADC High-Pass Filter Settings

For custom filter requirements, the programmable function allows custom coefficients to achieve a different filter than provided by the preset filters. The controls for the programmable high-pass filter are located under the **Programmable Filters** heading. The process should following the following steps:

1. Enter The filter coefficients can be entered in the **HP Filter** controls near the bottom of the tab.
2. Press the **Download Coefficients** button to download the coefficients to the codec registers.
3. Enable the Programmable High-Pass Filters by selecting the **Left ADC** and **Right ADC** buttons.

The programmable high-pass filter should now be correctly programmed and enabled. The ADC can now be enabled with the high-pass filter.

4.11.1.2 Digital Effects Filter - ADC

The ADC digital outputs stream can be routed through the digital effects filter in the codec to allow custom audio performance. The digital effects filter cannot operate on both the ADC or DAC at the same time. The digital effects filter operation is discussed in [Section 4.11.3](#)

4.11.2 DAC Filters

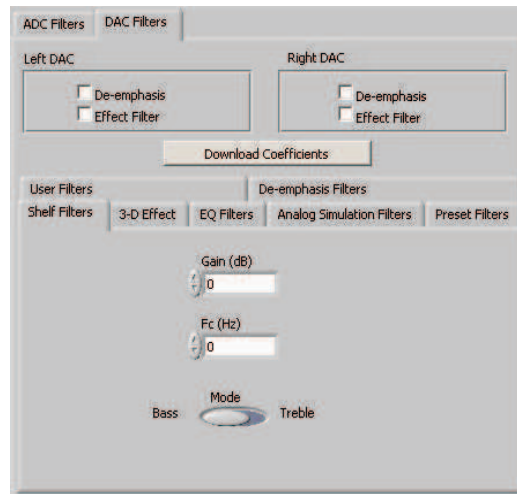

Figure 18. DAC Filters

4.11.2.1 De-emphasis Filters

The de-emphasis filters used in the TLV320AIC 3104 can be programmed as described in the [TLV320AIC3104](#) data sheet, using this tab (Figure 19). Enter the coefficients for the de-emphasis filter response desired. While on this tab, the de-emphasis response will be shown on the *Effect Filter Response* graph; however, note that this response is not included in graphs of other effect responses when on the other filter design tabs.

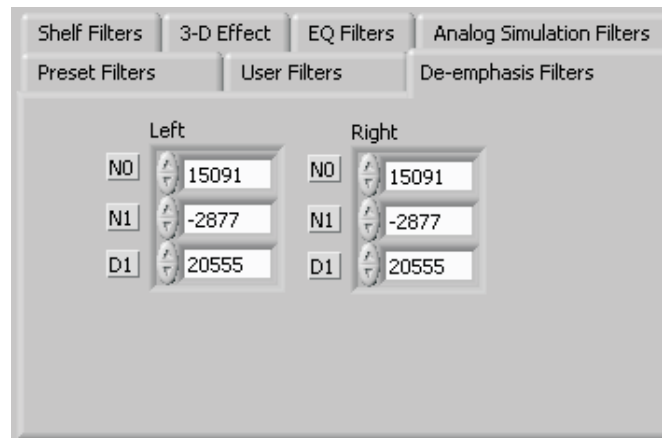

Figure 19. De-emphasis Filters

4.11.2.2 DAC Digital Effects Filter

The digital audio input stream can be routed through the digital effects filter in the codec before routing to the DAC to allow custom audio performance. The digital effects filter cannot operate on both the ADC or DAC at the same time. The digital effects filter operation is discussed in [Section 4.11.3](#)

4.11.3 Digital Effects Filters

The digital effect filters (the biquad filters) of the TLV320AIC3104 are selected using the check boxes shown in [Figure 20](#). The De-emphasis filters are described in the [TLV320AIC3104](#) data sheet, and their coefficients may be changed (see [Figure 18](#)).



Figure 20. Enabling Filters

When designing filters for use with TLV320AIC3104, the software allows for several different filter types to be used. These options are shown on a tab control in the lower left corner of the screen. When a filter type is selected, and suitable input parameters defined, the response will be shown in the *Effect Filter Response* graph. Regardless of the setting for enabling the Effect Filter, the filter coefficients are not loaded into the TLV320AIC3104 until the **Download Coefficients** button is pressed. To avoid noise during the update of coefficients, it is recommended that the user uncheck the **Effect Filter enable** check boxes before downloading coefficients. Once the desired coefficients are in the TLV320AIC3104, enable the Effect Filters by checking the boxes again.

4.11.3.1 Shelf Filters

A shelf filter is a simple filter that applies a gain (positive or negative) to frequencies above or below a certain corner frequency. As shown in [Figure 21](#), in *Bass* mode a shelf filter applies a gain to frequencies below the corner frequency; in *Treble* mode the gain is applied to frequencies above the corner frequency.

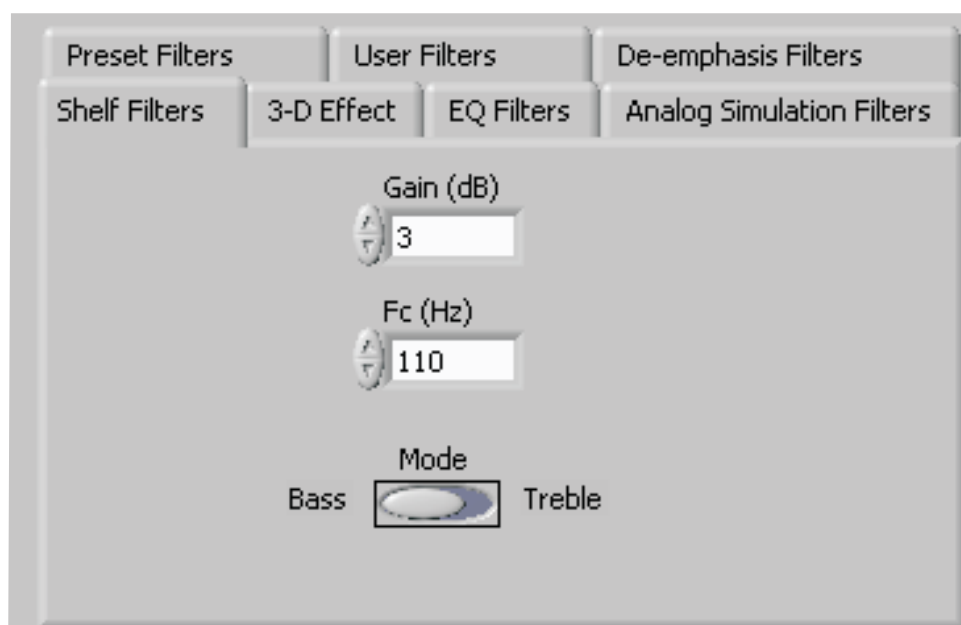

Figure 21. Shelf Filters

To use these filters, enter the gain desired and the corner frequency. Choose the mode to use (*Bass* or *Treble*); the response will be plotted on the *Effect Filter Response* graph.

4.11.3.2 EQ Filters

EQ, or parametric, filters can be designed on this tab (see [Figure 22](#)). Enter a gain, bandwidth, and a center frequency (Fc). Either bandpass (positive gain) or band-reject (negative gain) filters can be created

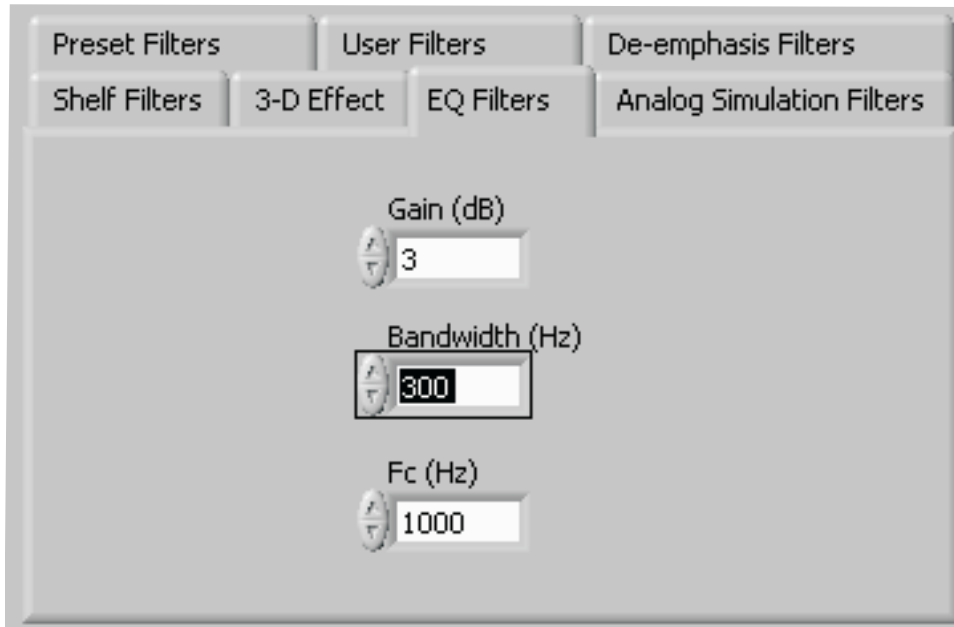

Figure 22. EQ Filters

4.11.3.3 Analog Simulation Filters

Biquads are quite good at simulating analog filter designs. For each biquad section on this tab, enter the desired analog filter type to simulate (Butterworth, Chebyshev, Inverse Chebyshev, Elliptic or Bessel). Parameter entry boxes appropriate to the filter type will be shown (ripple, for example, with Chebyshev filters, etc.). Enter the desired design parameters and the response will be shown. (See [Figure 23](#).)

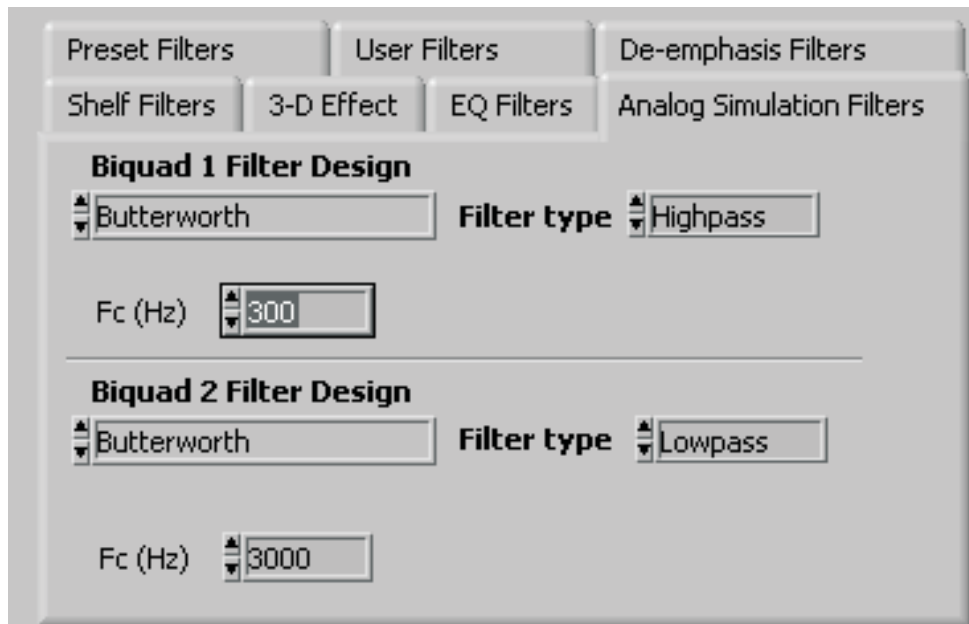

Figure 23. Analog Simulation Filters

4.11.3.4 Preset Filters

Many applications are designed to provide preset filters common for certain types of program material. This tab (see [Figure 24](#)) allows selection of one of four preset filter responses - Rock, Jazz, Classical, or Pop.

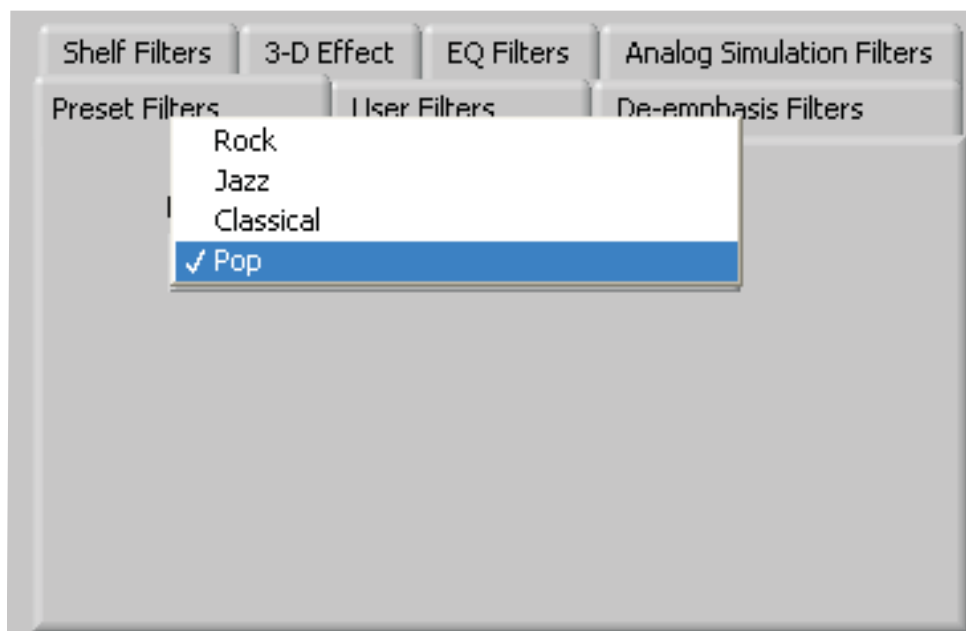

Figure 24. Preset Filters

4.11.3.5 User Filters

If filter coefficients are known, they can be entered directly on this tab (see [Figure 25](#)) for both biquads for both left and right channels. The filter response will **not** be shown on the *Effect Filter Response* graph for user filters.

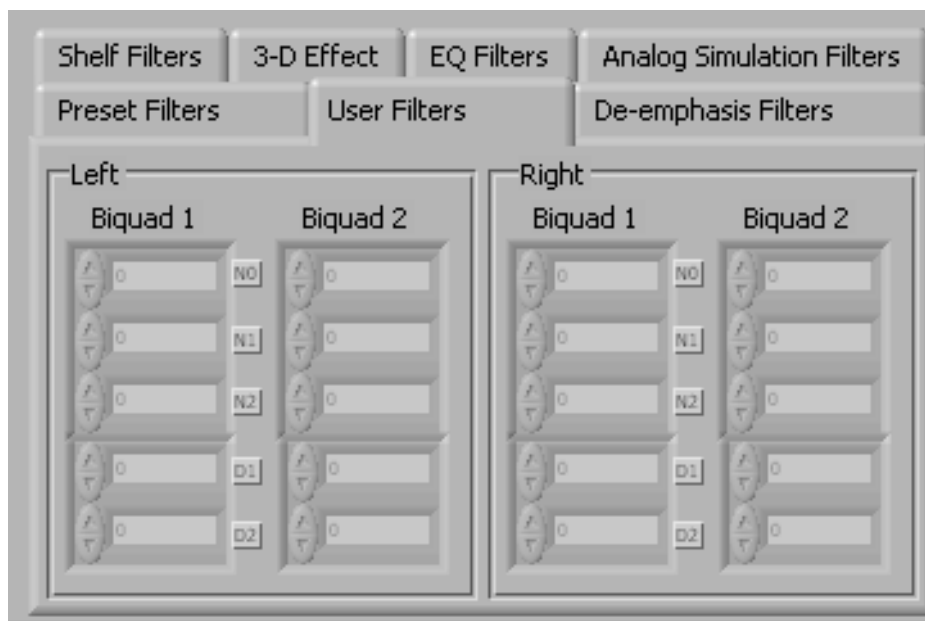

Figure 25. User Filters

4.11.3.6 3D Effect

The 3D effect is described in the [TLV320AIC3104](#) data sheet. It uses the two biquad sections differently than most other effect filter settings. To use this effect properly, make sure the appropriate coefficients are already loaded into the two biquad sections. The User Filters tab may be used to load the coefficients. See [Figure 26](#).

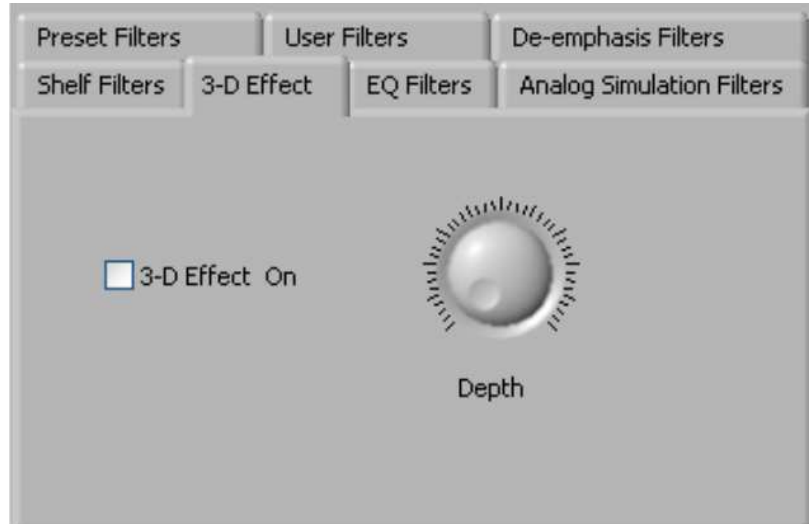

Figure 26. 3D Effect Settings

To enable the 3D effect, check the **3D Effect On** box. The **Depth** knob controls the value of the 3D Attenuation Coefficient.

4.12 Output Stage Configuration Tab

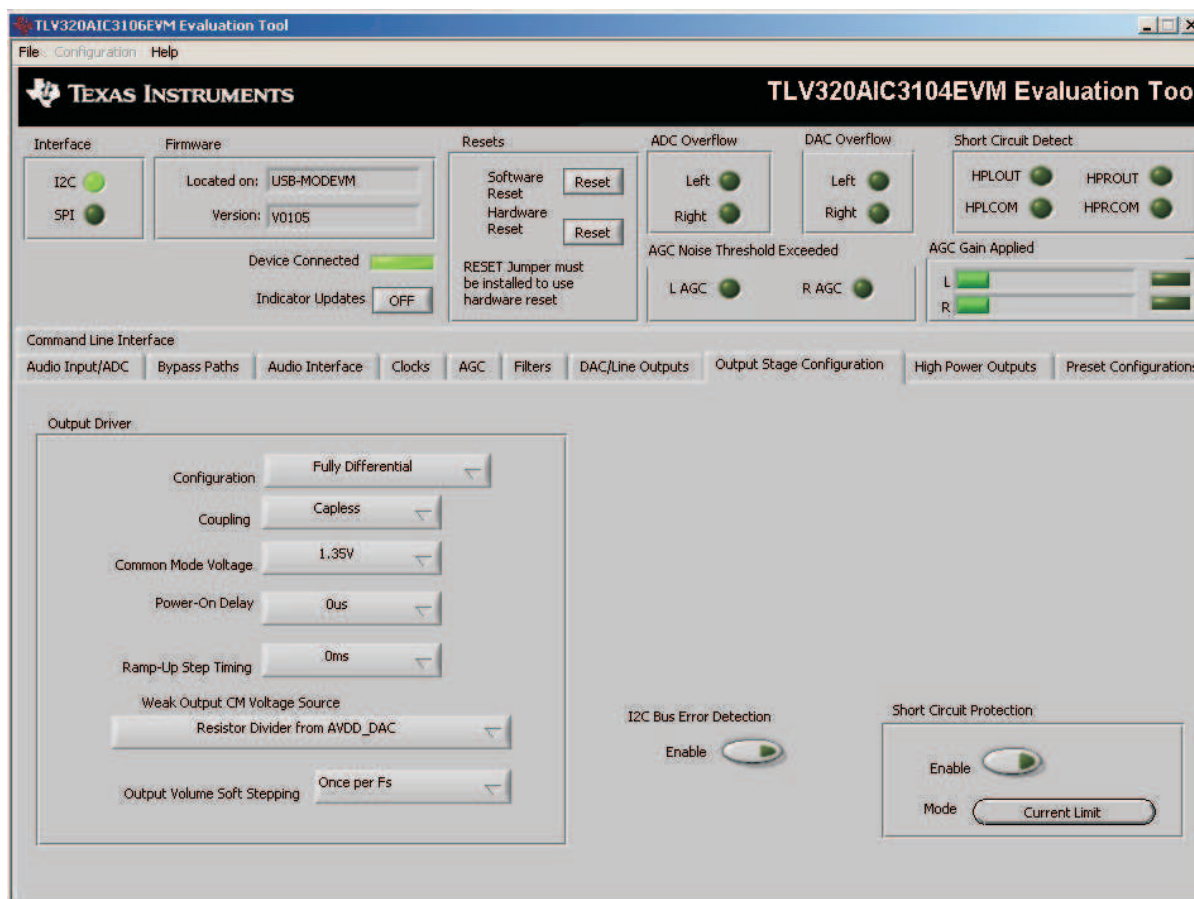

Figure 27. Output Stage Configuration Tab

The Output Stage Configuration tab (Figure 27) allows for setting various features of the output drivers.

The **Configuration** control may be set as either *Fully-Differential* or *Pseudo-Differential*. This control is used to determine if the output stage is being used to drive a fully differential output load or a output load where one of the outputs is referenced to a common-mode voltage (pseudo-differential).

The output **Coupling** control can be chosen as either *Capless* or *AC-coupled*. This setting should correspond to the setting of the hardware switch (SW1) on the TLV320AIC3104EVM.

The common mode voltage of the outputs may be set to 1.35 V, 1.5 V, 1.65 V, or 1.8 V using the **Common Mode Voltage** control.

The TLV320AIC3104 offers several options to help reduce the turnon/off pop of the output amplifiers. The **Power-On Delay** of the output drivers can be set using the corresponding control from 0's up to 4 seconds. **Ramp-Up Step Timing** can also be adjusted from 0ms to 4ms. The outputs can be set to soft-step their volume changes, using the **Output Volume Soft Stepping** control, and set to step once per F_s period, once per two F_s periods, or soft-stepping can be disabled altogether.

The high power outputs of the TLV320AIC3104 can be configured to go to a weak common-mode voltage when powered down. The source of this weak common-mode voltage can be set on this tab with the **Weak Output CM Voltage Source** drop-down. Choices for the source are either a resistor divider off the AVDD_DAC supply, or a bandgap reference. See the data sheet for more details on this option.

Headset detection features are enabled using the **Enable** button in the **Headset Detection** group box. When enabled, the indicators in the **HS/Button Detect** group box will light when either a button press or headset is detected. When a headset is detected, the type of headset is displayed in the **Detection Type** indicator. Debounce times for detection are set using the **Jack Detect Debounce** and **Button Press Debounce** controls, which offer debounce times in varying numbers of milliseconds. See the [TLV320AIC3104](#) data sheet for a discussion of headset detection.

Output short-circuit protection can be enabled in the **Short Circuit Protection** group box. Short Circuit Protection can use a current-limit mode, where the drivers will limit current output if a short-circuit condition is detected, or in a mode where the drivers will power down when such a condition exists.

The **I²C Bus Error Detection** button allows the user to enable circuitry which will set a register bit (Register 107, D0) if an I²C bus error is detected.

4.13 DAC/Line Outputs Tab

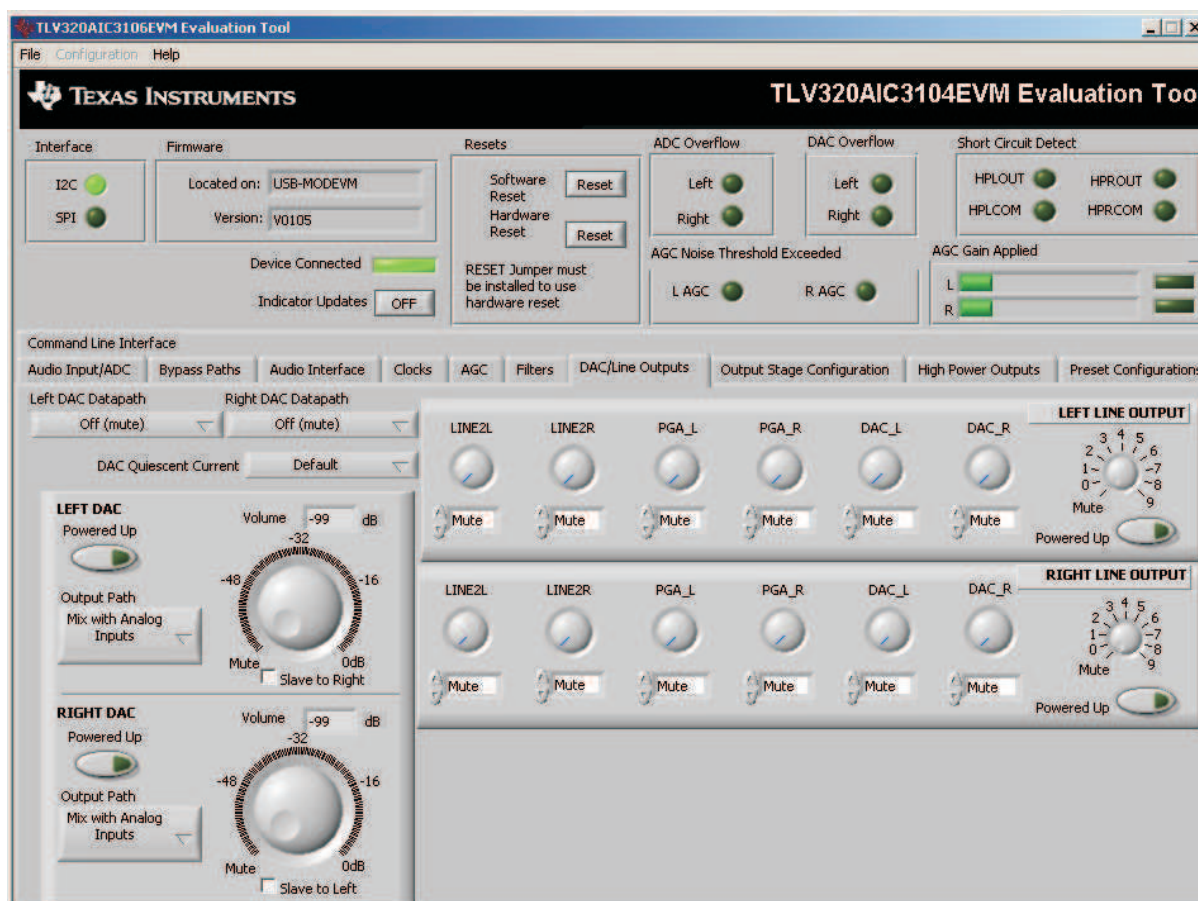

Figure 28. DAC/Line Outputs Tab

The DAC/Line Outputs tab controls the DAC power and volume, as well as routing of digital data to the DACs and the analog line output from the DACs. (See [Figure 28](#).)

4.13.1 DAC Controls

On the left side of this tab are controls for the left and right DACs.

In similar fashion as the ADC, the DAC controls are set up to allow powering of each DAC individually, and setting the output level. Each channel's level can be set independently using the corresponding **Volume** knob. Alternately, by checking the **Slave to Right** box, the left channel Volume can be made to track the right channel Volume knob setting; checking the **Slave to Left** box causes the right channel Volume knob to track the left Volume knob setting.

Data going to the DACs is selected using the drop-down boxes under the **Left** and **Right DAC Datapath**. Each DAC channel can be selected to be off, use left channel data, use right channel data, or use a mono mix of the left and right data.

Analog audio coming from the DACs is routed to outputs using the **Output Path** controls in each DAC control panel. The DAC output can be mixed with the analog inputs (LINE2L, LINE2R, PGA_L, PGA_R) and routed to the Line or High Power outputs using the mixer controls for these outputs on this tab (for the line outputs) or on the High Power Outputs tab (for the high power outputs). If the DAC is to be routed directly to either the Line or HP outputs, these can be selected as choices in the **Output Path** control. Note that if the Line or HP outputs are selected as the Output Path, the mixer controls on this tab and the High Power Output tabs have no effect.

4.13.2 Line Output Mixers

On the right side of this tab are horizontal panels where the analog output mixing functions for the line outputs are located.

Each line output master volume is controlled by the knob at the far right of these panels, below the line output labels. The output amplifier gain can be muted or set at a value between 0 and 9 dB in 1-dB steps. Power/Enabled status for the line output can also be controlled using the button below this master output knob (**Powered Up**).

If the DAC **Output Path** control is set to *Mix with Analog Inputs*, the six knobs in each panel can be used to set the individual level of signals routed and mixed to the line output. LINE2L, LINE2R, PGA_L, PGA_R, and DAC_L and DAC_R levels can each be set to create a custom mix of signals presented to that particular line output. **Note:** if the DAC **Output Path** control is set to anything other than *Mix with Analog Inputs*, these controls have no effect.

4.14 High-Power Outputs Tab



Figure 29. High-Power Outputs Tab

This tab contains four horizontal groupings of controls, one for each of the high power outputs. Each output has a mixer to mix the LINE2L, LINE2R, PGA_L, PGA_R, DAC_L and DAC_R signals, assuming that the DACs are not routed directly to the high power outputs (see Section 4.13).

At the left of each output strip is a **Powered Up** button that controls whether the corresponding output is powered up or not. The **When powered down** button allows the outputs to be tri-stated or driven weakly to a the output common mode voltage.

The **HPxCOM** outputs (*HPLCOM* and *HPRCOM*) can be used as independent output channels or can be used as complementary signals to the HPLOUT and HPROUT outputs. In these complementary configurations, the **HPxCOM** outputs can be selected as *Differential of HPxOUT* signals to the corresponding outputs or may be set to be a common mode voltage (*Constant VCM Out*). When used in these configurations, the **Powered Up** button for the **HPxCOM** output is disabled, as the power mode for that output will track the power status of the HPL or HPR output that the COM output is tracking.

The **HPRCOM Config** selector allows a couple additional options compared to the **HPLCOM Config** selector. *Differential of HPLCOM* allows the HPRCOM to be the complementary signal of HPLCOM for driving a differential load between the **HPxCOM** outputs. The selector also allows *Ext. Feedback/HPLCOM constant VCM* as an option. This option is used when the high power outputs are configured for *Capless* output drive, where HPLCOM is configured as *Constant VCM Out*. The feedback option provides feedback to the output and lowers the output impedance of HPLCOM.

At the right side of the output strip is a master volume knob for that output, which allows the output amplifier gain to be muted or set from 0 to 9 dB in 1-dB steps.

4.15 Command Line Interface Tab

A simple scripting language controls the TAS1020 on the USB-MODEVM from the LabView™-based PC software. The main program controls, described previously, do nothing more than write a script which is then handed off to an interpreter that sends the appropriate data to the correct USB endpoint. Because this system is script-based, provision is made in this tab for the user to view the scripting commands created as the controls are manipulated, as well as load and execute other scripts that have been written and saved (see Figure 30). This design allows the software to be used as a quick test tool or to help provide troubleshooting information in the rare event that the user encounters problem with this EVM.

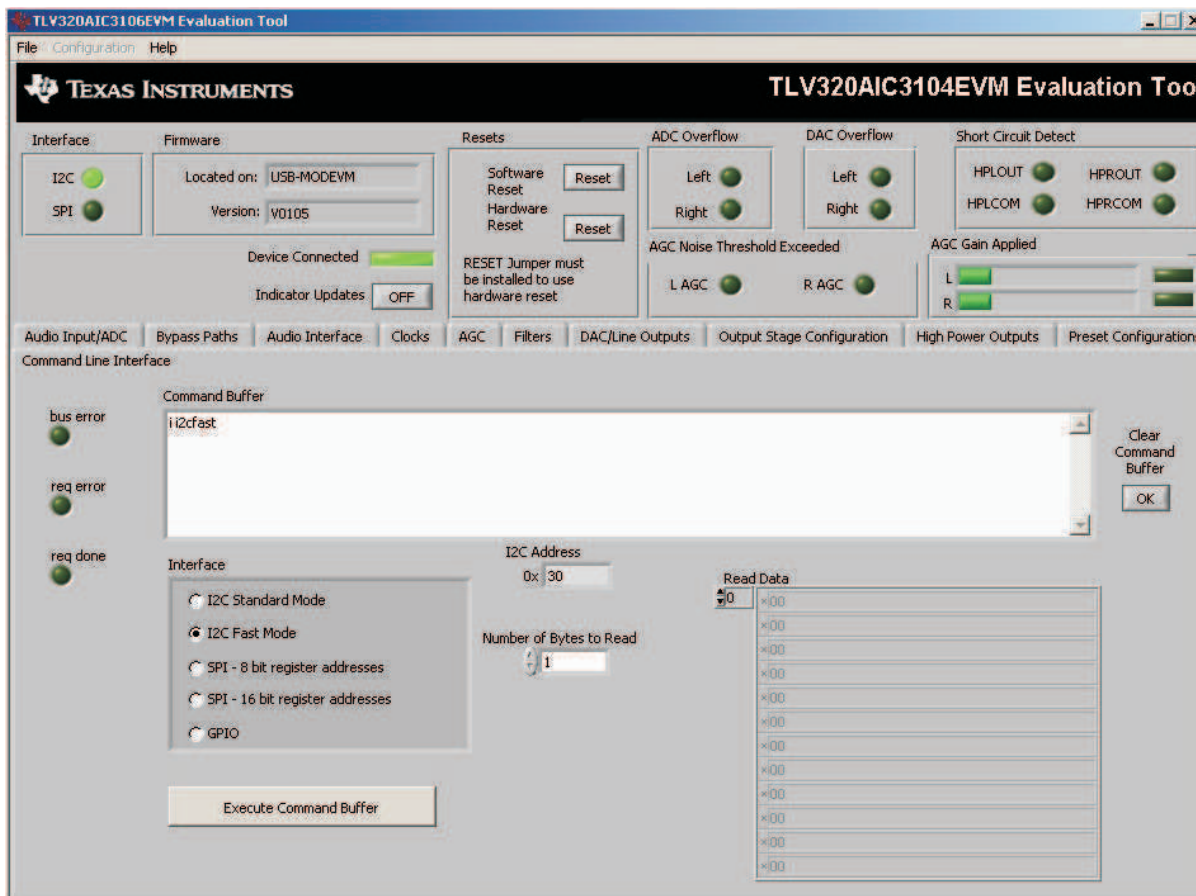

Figure 30. Command Line Interface Tab

A script is loaded into the command buffer, either by operating the controls on the other tabs or by loading a script file. When executed, the return packets of data which result from each command will be displayed in the **Read Data** array control. When executing several commands, the Read Data control shows only the results of the last command. To see the results after every executed command, use the logging function described below.

The File menu (Figure 31) provides some options for working with scripts. The first option, *Open Command File...*, loads a command file script into the command buffer. This script can then be executed by pressing the **Execute Command Buffer** button.

The second option is *Log Script and Results...*, which opens a file save dialog box. Choose a location for a log file to be written using this file save dialog. When the Execute Command Buffer button is pressed, the script will run and the script, along with resulting data read back during the script, will be saved to the file specified. The log file is a standard text file that can be opened with any text editor, and looks much like the source script file, but with the additional information of the result of each script command executed.

The third menu item is a submenu of *Recently Opened Files*. This is simply a list of script files that have previously been opened, allowing fast access to commonly-used script files. The final menu item is *Exit*, which terminates the TLV320AIC3104EVM software.

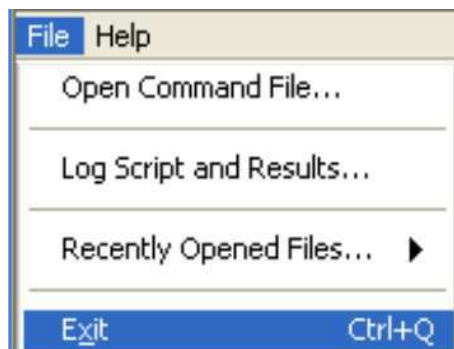

Figure 31. File Menu

Under the Help menu is an *About...* menu item which displays information about the TLV320AIC3104EVM software.

The actual USB protocol used as well as instructions on writing scripts are detailed in the following subsections. While it is not necessary to understand or use either the protocol or the scripts directly, understanding them may be helpful to some users.

Appendix A EVM Connector Descriptions

This appendix contains the connection details for each of the main header connectors on the EVM.

A.1 Analog Interface Connectors

A.1.1 Analog Dual-Row Header Details (J13 and J14)

For maximum flexibility, the TLV320AIC3104EVM is designed for easy interfacing to multiple analog sources. Samtec part numbers SSW-110-22-F-D-VS-K and TSM-110-01-T-DV-P provide a convenient 10-pin dual row header/socket combination at J13 and J14. These headers/sockets provide access to the analog input and output pins of the device. Consult Samtec at www.samtec.com or call 1-800-SAMTEC-9 for a variety of mating connector options. [Table A-1](#) summarizes the analog interface pinout for the TLV320AIC3104EVM..

Table A-1. Analog Interface Pinout

PIN NUMBER	SIGNAL	DESCRIPTION
J13.1	HPLCOM	High-Power Output Driver (Left Minus or Multifunctional)
J13.2	HPLOUT	High-Power Output Driver (Left Plus)
J13.3	HPRCOM	High-Power Output Driver (Right Minus or Multifunctional)
J13.4	HPROUT	High-Power Output Driver (Right Plus)
J13.5	LINE1LM	MIC1 or LINE1 Analog Input (Left Minus or Multifunctional)
J13.6	LINE1LP	MIC1 or LINE1 Analog Input (Left Plus or Multifunctional)
J13.7	LINE1RM	MIC1 or LINE1 Analog Input (Right Minus or Multifunctional)
J13.8	LINE1RP	MIC1 or LINE1 Analog Input (Right Plus or Multifunctional)
J13.9	AGND	Analog Ground
J13.10	MIC3L	MIC3 Input (Left or Multifunctional)
J13.11	AGND	Analog Ground
J13.12	MIC3R	MIC3 Input (Right or Multifunctional)
J13.13	AGND	Analog Ground
J13.14	MICBIAS	Microphone Bias Voltage Output
J13.15	NC	Not Connected
J13.16	MICDET	Microphone Detect
J13.17	AGND	Analog Ground
J13.18	NC	Not Connected
J13.19	AGND	Analog Ground
J13.20	NC	Not Connected
J14.1	LINE2RM	MIC2 or LINE2 Analog Input (Right Minus or Multifunctional)
J14.2	LINE2RP	MIC2 or LINE2 Analog Input (Right Plus or Multifunctional)
J14.3	LINE2LM	MIC2 or LINE2 Analog Input (Left Minus or Multifunctional)
J14.4	LINE2RP	MIC2 or LINE2 Analog Input (Left Plus or Multifunctional)
J14.5	MONO_LOP	Mono-Line Output (Plus)
J14.6	MONO_LOM	Mono-Line Output (Minus)
J14.7	LEFT_LOP	Left-Line Output (Plus)
J14.8	LEFT_LOM	Left-Line Output (Minus)
J14.9	AGND	Analog Ground
J14.10	RIGHT_LOP	Right-Line Output (Plus)
J14.11	AGND	Analog Ground
J14.12	RIGHT_LOM	Right-Line Output (Minus)
J14.13	AGND	Analog Ground
J14.14	NC	Not Connected
J14.15	NC	Not Connected
J14.16	NC	Not Connected

Table A-1. Analog Interface Pinout (continued)

PIN NUMBER	SIGNAL	DESCRIPTION
J14.17	AGND	Analog Ground
J14.18	NC	Not Connected
J14.19	AGND	Analog Ground
J14.20	NC	Not Connected

A.1.2 Analog Screw Terminal Details (J1-5 and J8-12)

In addition to the analog headers, the analog inputs and outputs can also be accessed through alternate connectors, either screw terminals or audio jacks. The stereo microphone input is also tied to J6 and the stereo headphone output (the HP set of outputs) is available at J7.

Table A-2 summarizes the screw terminals available on the TLV320AIC3104EVM.

Table A-2. Alternate Analog Connectors

DESIGNATOR	PIN 1	PIN 2	PIN3
J1	LINE1LP	LINE1LM	
J2	LINE1RP	LINE1RM	
J3	LINE2LP	LINE2LM	
J4	LINE2RP	LINE2RM	
J5	MIC3 IN LEFT	MIC3 IN RIGHT	AGND
J8	MONO OUT -	MONO OUT +	
J9	LEFT OUT -	LEFT OUT +	
J10	RIGHT OUT -	RIGHT OUT +	
J11	(+) HPLOUT	(-) HPLCOM	
J12	(+) HPROUT	(-) HPRCOM	

A.2 Digital Interface Connectors (J16 and J17)

The TLV320AIC3104EVM is designed to easily interface with multiple control platforms. Samtec part numbers SSW-110-22-F-D-VS-K and TSM-110-01-T-DV-P provide a convenient 10-pin dual row header/socket combination at J16 and J17. These headers/sockets provide access to the digital control and serial data pins of the device. Consult Samtec at www.samtec.com or call 1-800-SAMTEC-9 for a variety of mating connector options. [Table A-3](#) summarizes the digital interface pinout for the TLV320AIC3104EVM.

Table A-3. Digital Interface Pinout

PIN NUMBER	SIGNAL	DESCRIPTION
J16.1	NC	Not Connected
J16.2	GPIO1	General-Purpose Input/Output #1
J16.3	SCLK	SPI Serial Clock
J16.4	DGND	Digital Ground
J16.5	NC	Not Connected
J16.6	GPIO2	General Purpose Input/Output #2
J16.7	/SS	SPI Chip Select
J16.8	RESET INPUT	Reset signal input to AIC33EVM
J16.9	NC	Not Connected
J16.10	DGND	Digital Ground
J16.11	MOSI	SPI MOSI Slave Serial Data Input
J16.12	SPI SELECT	Select Pin (SPI vs I ² C Control Mode)
J16.13	MISO	SPI MISO Slave Serial Data Output
J16.14	AIC33 RESET	Reset
J16.15	NC	Not Connected
J16.16	SCL	I ² C Serial Clock
J16.17	NC	Not Connected
J16.18	DGND	Digital Ground
J16.19	NC	Not Connected
J16.20	SDA	I ² C Serial Data Input/Output
J17.1	NC	Not Connected
J17.2	NC	Not Connected
J17.3	BCLK	Audio Serial Data Bus Bit Clock (Input/Output)
J17.4	DGND	Digital Ground
J17.5	NC	Not Connected
J17.6	NC	Not Connected
J17.7	WCLK	Audio Serial Data Bus Word Clock (Input/Output)
J17.8	NC	Not Connected
J17.9	NC	Not Connected
J17.10	DGND	Digital Ground
J17.11	DIN	Audio Serial Data Bus Data Input (Input)
J17.12	NC	Not Connected
J17.13	DOUT	Audio Serial Data Bus Data Output (Output)
J17.14	NC	Not Connected
J17.15	NC	Not Connected
J17.16	SCL	I ² C Serial Clock
J17.17	MCLK	Master Clock Input
J17.18	DGND	Digital Ground
J17.19	NC	Not Connected
J17.20	SDA	I ² C Serial Data Input/Output

Power Supply Connector Pin Header, J15

Note that J17 comprises the signals needed for an I²S™ serial digital audio interface; the control interface (I²C™ and $\overline{\text{RESET}}$) signals are routed to J16. I²C is actually routed to both connectors; however, the device is connected only to J16.

A.3 Power Supply Connector Pin Header, J15

J15 provides connection to the common power bus for the TLV320AIC3104EVM. Power is supplied on the pins listed in [Table A-4](#).

Table A-4. Power Supply Pinout

SIGNAL	PIN NUMBER		SIGNAL
NC	J15.1	J15.2	NC
+5VA	J15.3	J15.4	NC
DGND	J15.5	J15.6	AGND
DVDD (1.8V)	J15.7	J15.8	NC
IOVDD (3.3V)	J15.9	J15.10	NC

The TLV320AIC3104EVM-PDK motherboard (the USB-MODEVM Interface board) supplies power to J15 of the TLV320AIC3104EVM. Power for the motherboard is supplied either through its USB connection or via terminal blocks on that board.

Appendix B TLV320AIC3104EVM Schematic

The schematic diagram for the modular TLV320AIC3104EVM is provided as a reference.

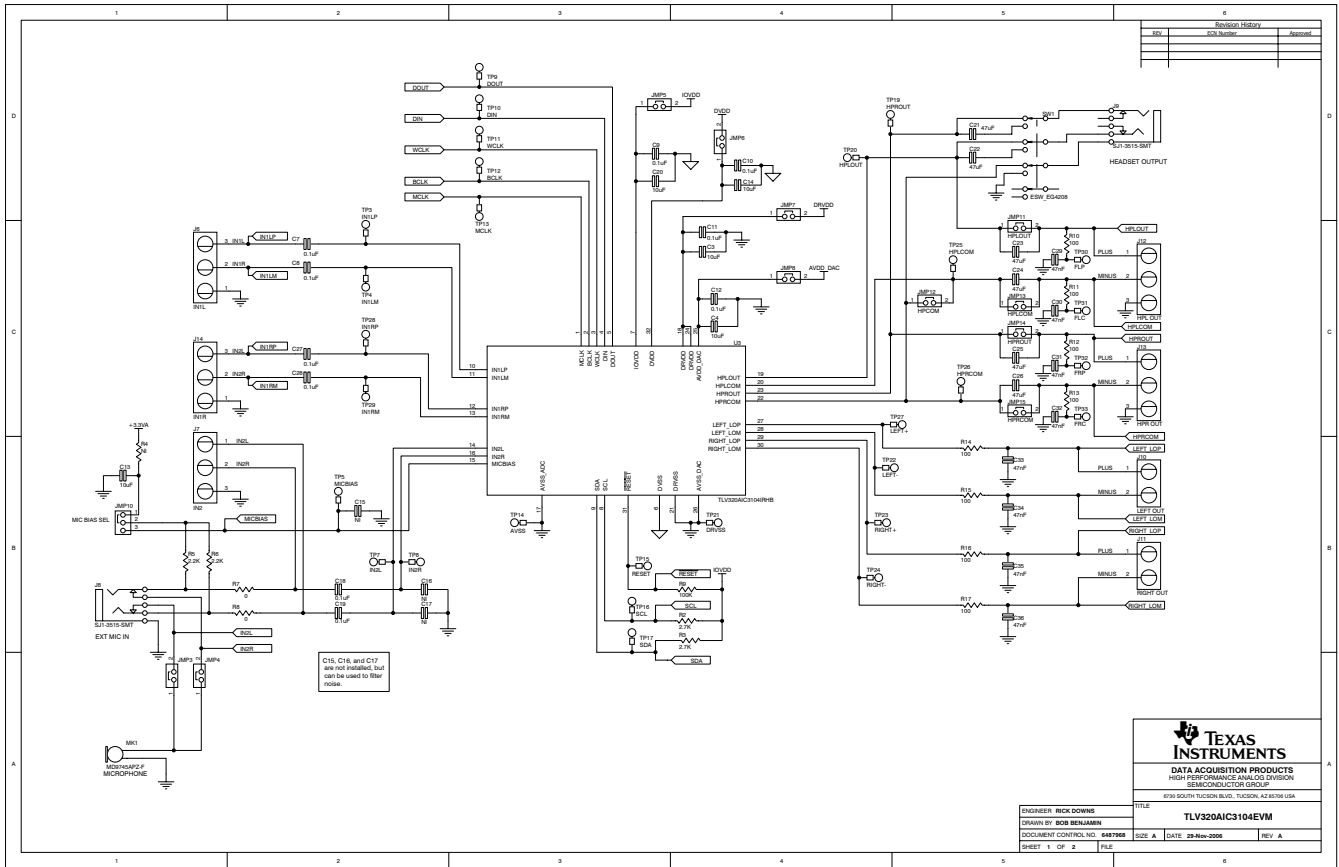

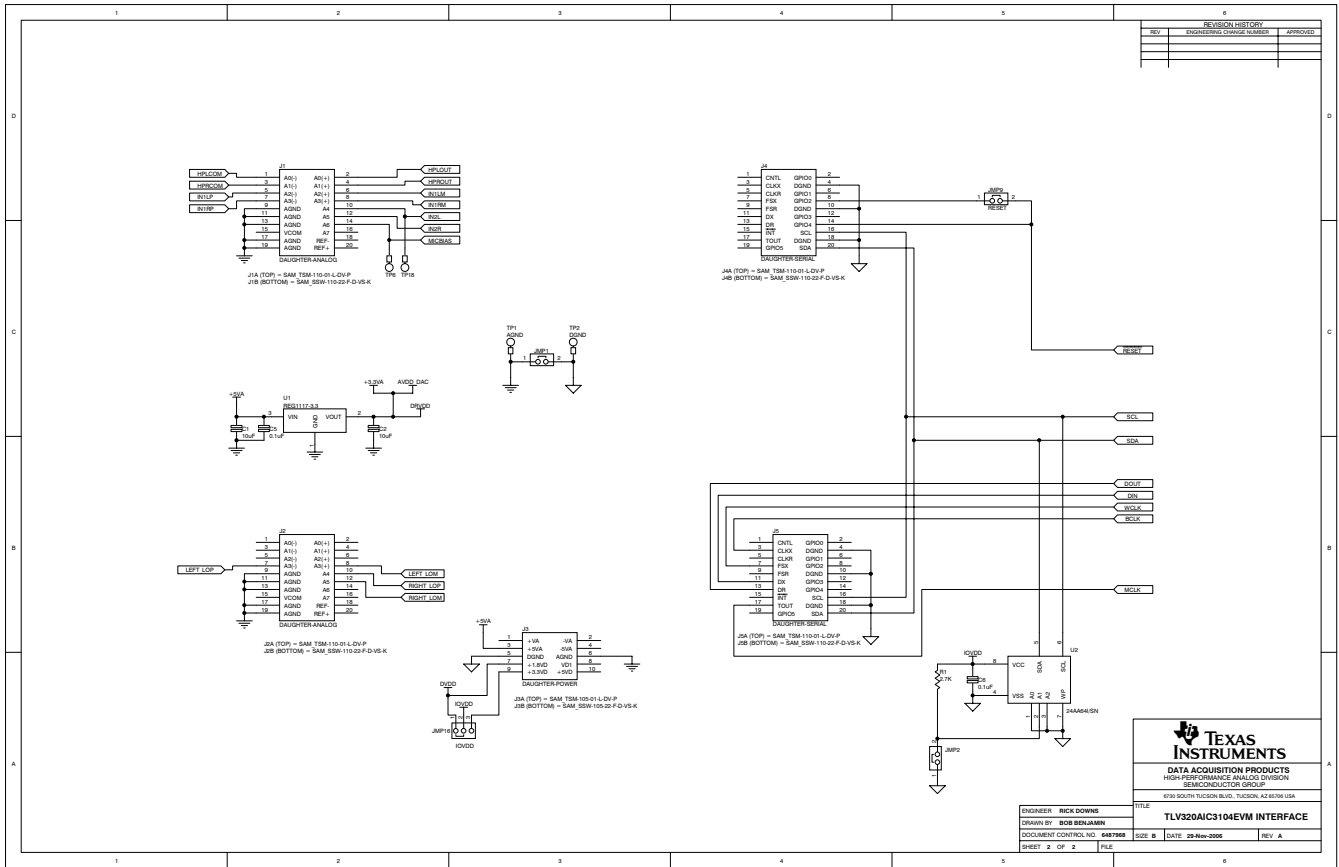

Appendix C TLV320AIC3104EVM Layout Views

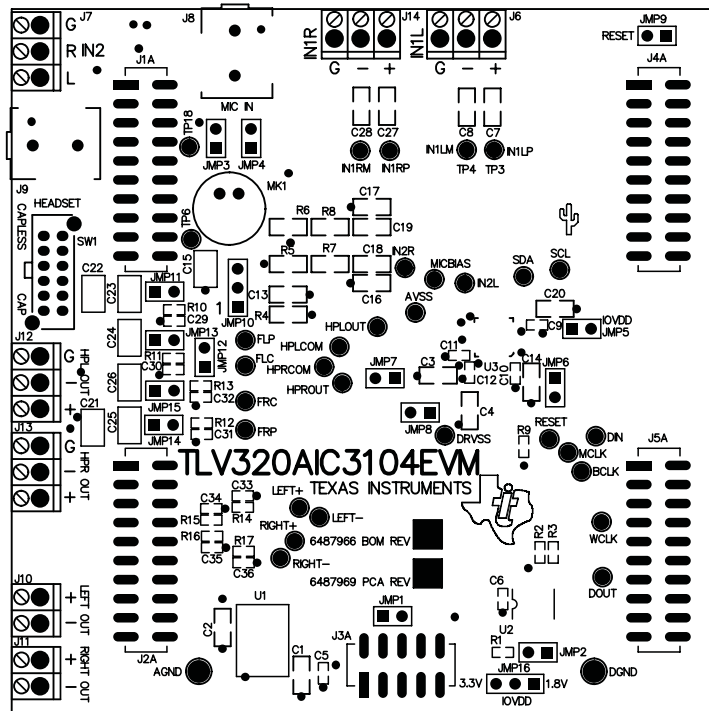

Figure C-1. Assembly layer

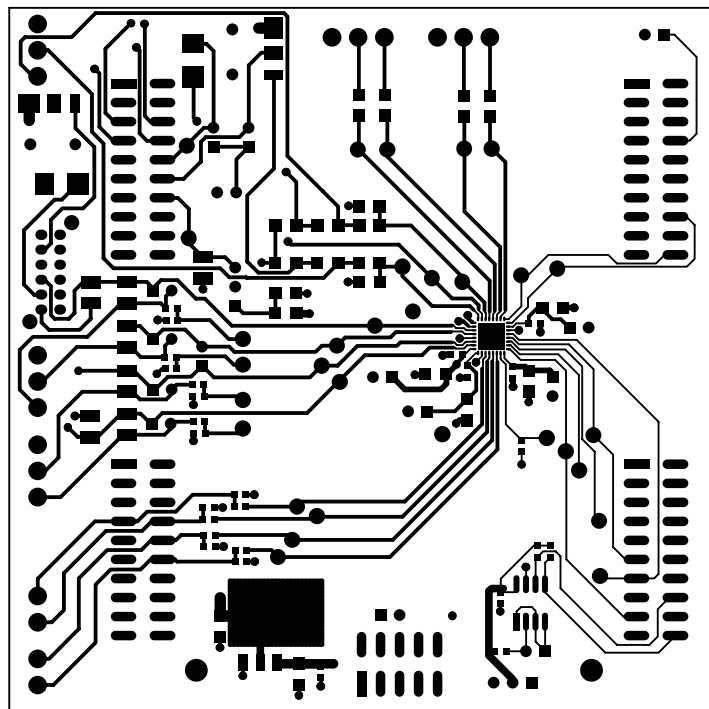

Figure C-2. Top Layer

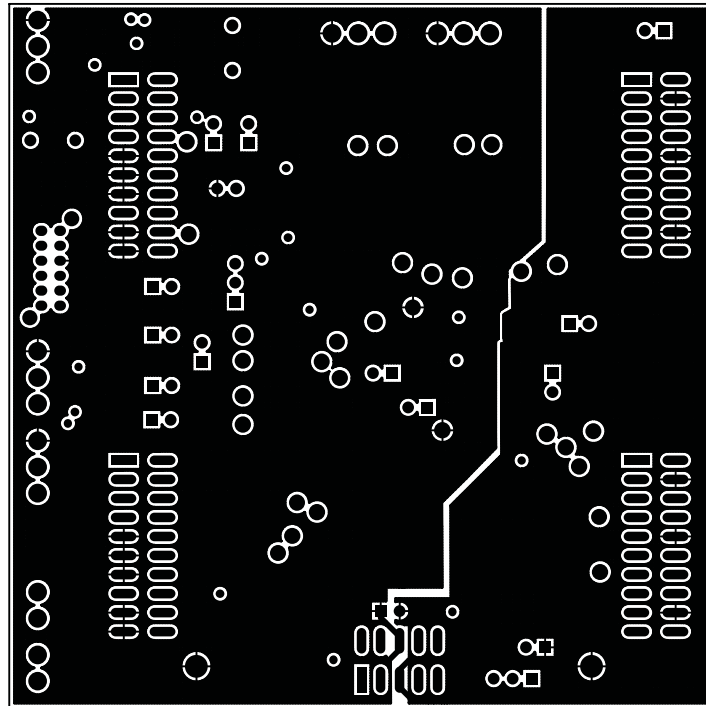

Figure C-3. Layer 3

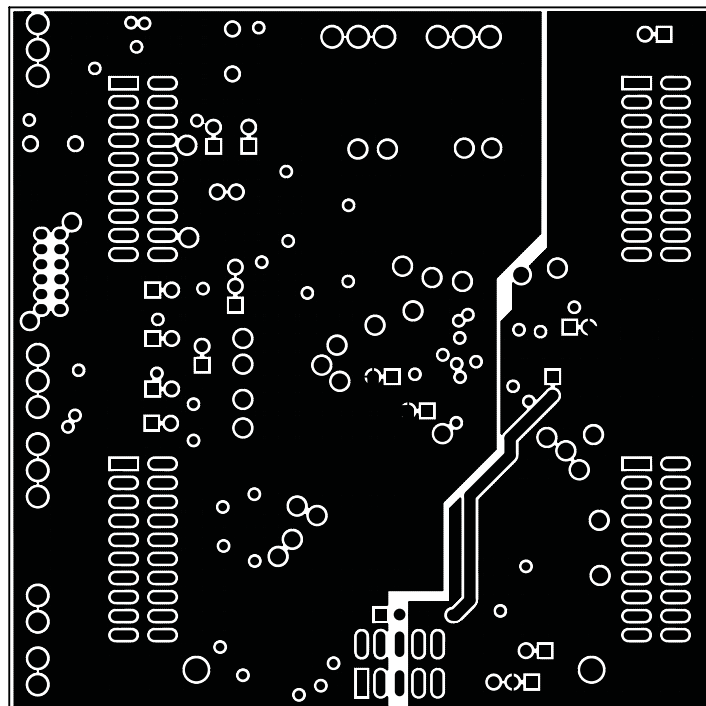

Figure C-4. Layer 4

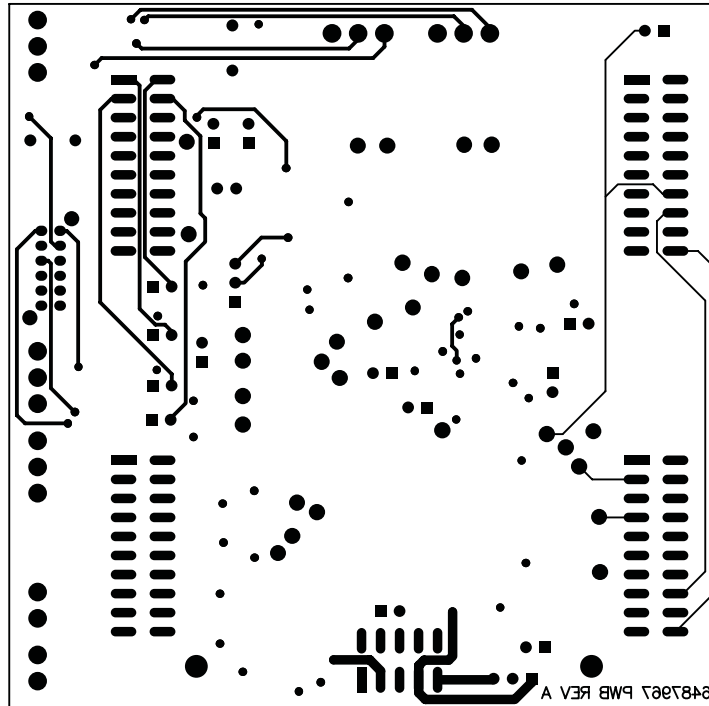

Figure C-5. Silk Screen

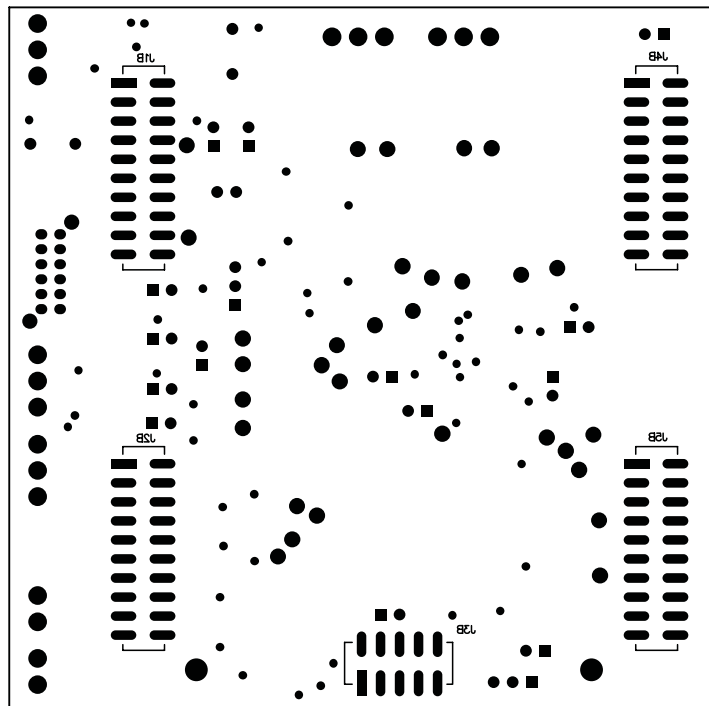

Figure C-6. Bottom Layer

Appendix D TLV320AIC3104EVM Bill of Materials

The complete bill of materials for the modular TLV320AIC3104EVM is provided as a reference.

Table D-1. TLV320AIC3104EVM Bill of Materials

QTY	Value	Ref Des	Description	Manufacturer	Mfr Part Number
2	0	R7, R8	1/4W 5% Chip Resistor	Panasonic	ERJ-8GEY0R00V
8	100	R10–R17	1/10W 1% Chip Resistor	Panasonic	ERJ-3EKF1000V
2	2.2k	R5, R6	1/4W 5% Chip Resistor	Panasonic	ERJ-8GEYJ222V
3	2.7K	R1, R2, R3	1/10W 5% Chip Resistor	Panasonic	ERJ-3GEYJ272V
1	100K	R9	1/10W 5% Chip Resistor	Panasonic	ERJ-3GEYJ104V
1	NI	R4	Chip Resistor		
8	47 nF	C29–C36	50V Ceramic chip capacitor, ±10%, X7R	TDK	C1608X7R1H473K
6	0.1 µF	C5, C6, C9–C12	16V Ceramic Chip Capacitor, ±10%, X7R	TDK	C1608X7R1C104K
6	0.1 µF	C7, C8, C18, C19, C27, C28	100V Ceramic Chip Capacitor, ±10%, X7R	TDK	C3216X7R2A104K
7	10 µF	C1–C4, C13, C14, C20	6.3V Ceramic Chip Capacitor, ±10%, X5R	TDK	C3216X5R0J106K
6	47 µF	C21–C26	6.3V Ceramic Chip Capacitor, ±20%, X5R	TDK	C3225X5R0J476M
2	NI	C16, C17	Ceramic Chip Capacitor		
1	NI	C15	Ceramic Chip Capacitor		
1		U3	Audio Codec	Texas Instruments	TLV320AIC3104IRHB
1		U1	3.3V LDO Voltage Regulator	Texas Instruments	REG1117-3.3
1		U2	64K I2C EEPROM	MicroChip	24AA64-I/SN
2		J10, J11	Screw Terminal Block, 2 Position	On Shore Technology	ED555/2DS
5		J6, J7, J12–J14	Screw Terminal Block, 3 Position	On Shore Technology	ED555/3DS
2		J8, J9	3,5 mm Audio Jack, T-R-S, SMD	CUI Inc.	SJ1-3515-SMT
			or alternate	KobiConn	161-3335-E
4		J1A, J2A, J4A, J5A	20 Pin SMT Plug	Samtec	TSM-110-01-L-DV-P
4		J1B, J2B, J4B, J5B	20 pin SMT Socket	Samtec	SSW-110-22-F-D-VS-K
1		J3A	10 Pin SMT Plug	Samtec	TSM-105-01-L-DV-P
1		J3B	10 pin SMT Socket	Samtec	SSW-105-22-F-D-VS-K
1		N/A	TLV320AIC3104EVM PWB	Texas Instruments	6487967
10		JMP1–JMP4, JMP9, JMP11–JMP15	2 Position Jumper, 0.1" spacing	Samtec	TSW-102-07-L-S
4		JMP5–JMP8	Bus Wire (18-22 Gauge)		
2		JMP10, JMP16	3 Position Jumper, 0.1" spacing	Samtec	TSW-103-07-L-S
1		MK1	Omnidirectional Microphone Cartridge	Knowles Acoustics	MD9745APZ-F
			alternate	Knowles Acoustics	MD9745APA-1
1		SW1	4PDT Right Angle Switch	E-Switch	EG4208
31	Not Installed	TP3–TP33	Miniature Test Point Terminal	Keystone Electronics	5000
2		TP1, TP2	Multipurpose Test Point Terminal	Keystone Electronics	5011
12		N/A	Header Shorting Block	Samtec	SNT-100-BK-T

ATTENTION: All components should be RoHS compliant. Some part number may be either leaded or RoHS. Verify purchased components are RoHS compliant.

Appendix E USB-MODEVM Schematic

The schematic diagram for USB-MODEVM Interface Board (included only in the TLV320AIC3104EVM-PDK) is provided as a reference.

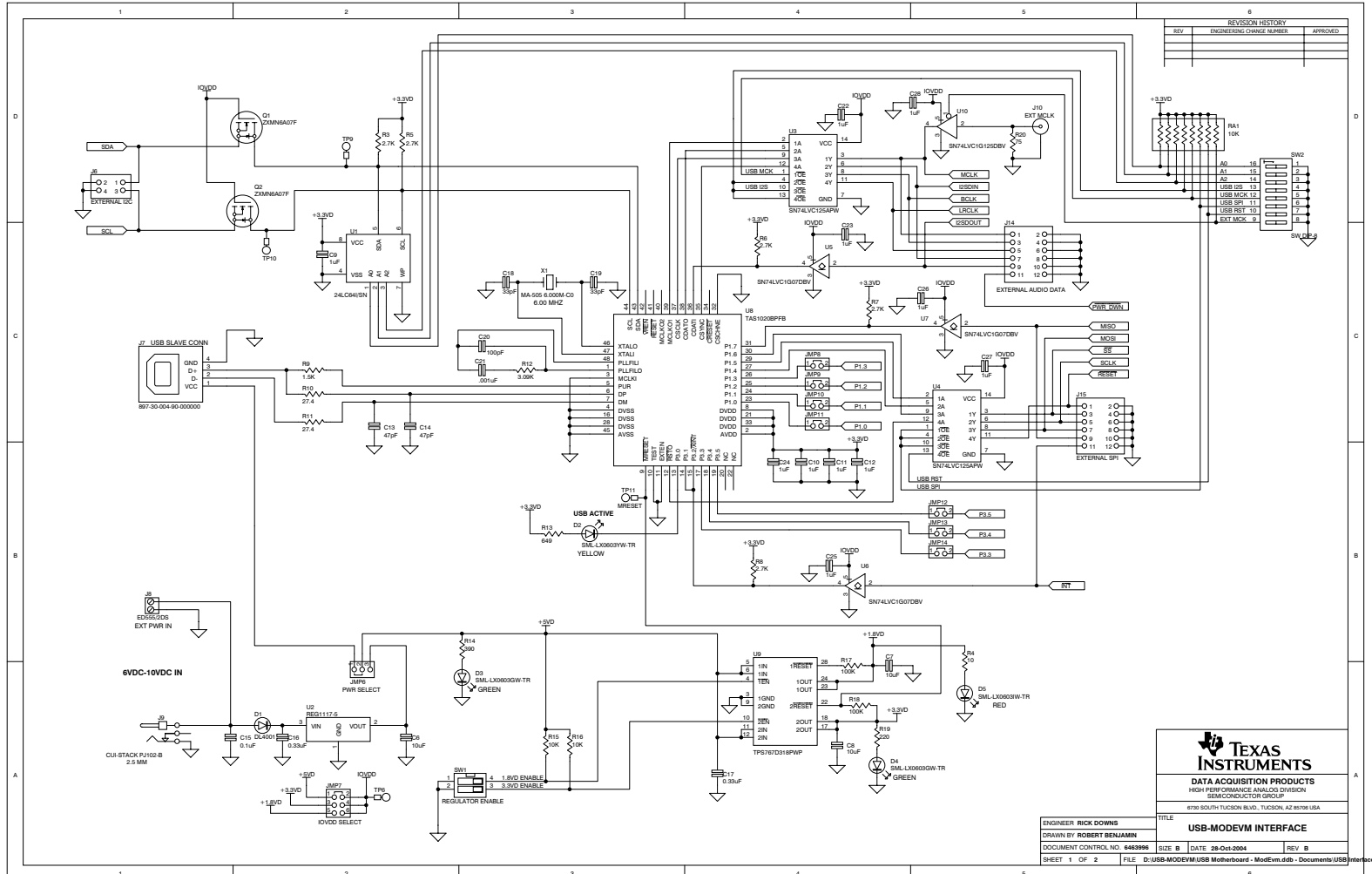

TEXAS INSTRUMENTS
 DATA ACQUISITION PRODUCTS
 HIGH PERFORMANCE ANALOG DESIGN
 SEMICONDUCTOR GROUP

ENGINEER RICK DOWNS TITLE
 DRAWN BY ROBERT BENJAMIN
 DOCUMENT CONTROL NO. 648398 SIZE B DATE 28-Oct-2004 REV B
 SHEET 1 OF 2 FILE D:\USB-MODEVM\USB ModemBoard - ModEm.dsb - Documents\USB

REVISION HISTORY		
REV	ENGINEERING CHANGE NUMBER	APPROVED

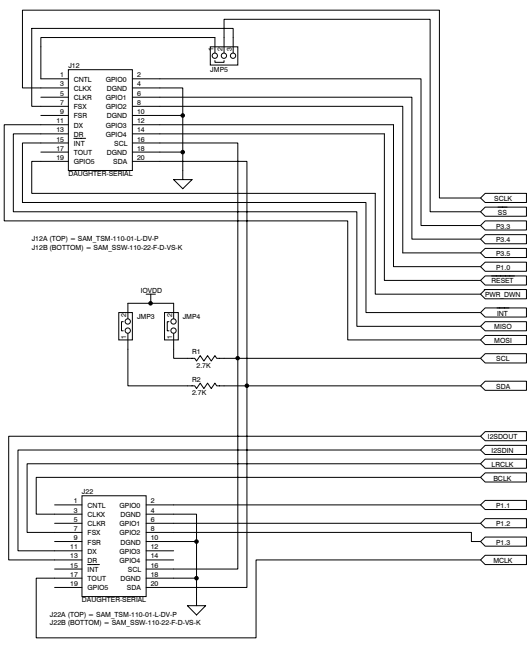
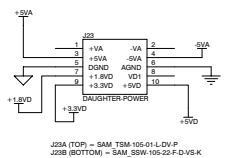
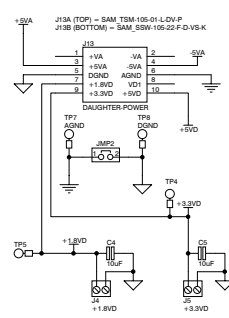
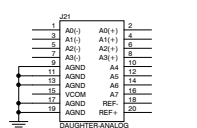
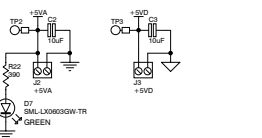
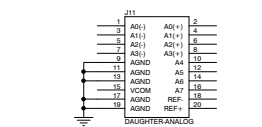

TEXAS INSTRUMENTS
 DATA ACQUISITION PRODUCTS
 HIGH-PERFORMANCE ANALOG DIVISION
 SEMICONDUCTOR GROUP

ENGINEER	RICK DOWNS	TITLE	USB-MODEM INTERFACE
DRAWN BY	ROBERT BENJAMIN	DATE	28-Oct-2004
DOCUMENT CONTROL NO.	648998	SIZE	B
SHEET	2 OF 2	FILE	D:\USB-MODEM\USB ModemBoard - ModEm.dwg - Documents\Design

Appendix F USB-MODEVM Bill of Materials

The complete bill of materials for USB-MODEVM Interface Board (included only in the TLV320AIC3104EVM-PDK) is provided as a reference.

Table F-1. USB-MODEVM Bill of Materials

Designators	Description	Manufacturer	Mfr Part Number
R4	10Ω 1/10W 5% Chip Resistor	Panasonic	ERJ-3GEYJ1300V
R10, R11	27.4Ω 1/16W 1% Chip Resistor	Panasonic	ERJ-3EKF27R4V
R20	75Ω 1/4W 1% Chip Resistor	Panasonic	ERJ-14NF75R0U
R19	220Ω 1/10W 5% Chip Resistor	Panasonic	ERJ-3GEYJ221V
R14, R21, R22	390Ω 1/10W 5% Chip Resistor	Panasonic	ERJ-3GEYJ391V
R13	649Ω 1/16W 1% Chip Resistor	Panasonic	ERJ-3EKF6490V
R9	1.5KΩ 1/10W 5% Chip Resistor	Panasonic	ERJ-3GEYJ1352V
R1–R3, R5–R8	2.7KΩ 1/10W 5% Chip Resistor	Panasonic	ERJ-3GEYJ272V
R12	3.09KΩ 1/16W 1% Chip Resistor	Panasonic	ERJ-3EKF3091V
R15, R16	10KΩ 1/10W 5% Chip Resistor	Panasonic	ERJ-3GEYJ1303V
R17, R18	100kΩ 1/10W 5% Chip Resistor	Panasonic	ERJ-3GEYJ1304V
RA1	10KΩ 1/8W Octal Isolated Resistor Array	CTS Corporation	742C163103JTR
C18, C19	33pF 50V Ceramic Chip Capacitor, ±5%, NPO	TDK	C1608C0G1H330J
C13, C14	47pF 50V Ceramic Chip Capacitor, ±5%, NPO	TDK	C1608C0G1H470J
C20	100pF 50V Ceramic Chip Capacitor, ±5%, NPO	TDK	C1608C0G1H101J
C21	1000pF 50V Ceramic Chip Capacitor, ±5%, NPO	TDK	C1608C0G1H102J
C15	0.1μF 16V Ceramic Chip Capacitor, ±10%, X7R	TDK	C1608X7R1C104K
C16, C17	0.33μF 16V Ceramic Chip Capacitor, ±20%, Y5V	TDK	C1608X5R1C334K
C9–C12, C22–C28	1μF 6.3V Ceramic Chip Capacitor, ±10%, X5R	TDK	C1608X5R0J1305K
C1–C8	10μF 6.3V Ceramic Chip Capacitor, ±10%, X5R	TDK	C3216X5R0J1306K
D1	50V, 1A, Diode MELF SMD	Micro Commercial Components	DL4001
D2	Yellow Light Emitting Diode	Lumex	SML-LX0603YW-TR
D3–D7	Green Light Emitting Diode	Lumex	SML-LX0603GW-TR
D5	Red Light Emitting Diode	Lumex	SML-LX0603IW-TR
Q1, Q2	N-Channel MOSFET	Zetex	ZXMN6A07F
X1	6MHz Crystal SMD	Epson	MA-505 6.000M-C0
U8	USB Streaming Controller	Texas Instruments	TAS1020BPFB
U2	5V LDO Regulator	Texas Instruments	REG1117-5
U9	3.3V/1.8V Dual Output LDO Regulator	Texas Instruments	TPS767D318PWP
U3, U4	Quad, 3-State Buffers	Texas Instruments	SN74LVC125APW
U5–U7	Single IC Buffer Driver with Open Drain o/p	Texas Instruments	SN74LVC1G07DBVR
U10	Single 3-State Buffer	Texas Instruments	SN74LVC1G125DBVR
U1	64K 2-Wire Serial EEPROM I ² C	Microchip	24LC64I/SN
	USB-MODEVM PCB	Texas Instruments	6463995
TP1–TP6, TP9–TP11	Miniature test point terminal	Keystone Electronics	5000
TP7, TP8	Multipurpose test point terminal	Keystone Electronics	5011
J7	USB Type B Slave Connector Thru-Hole	Mill-Max	897-30-004-90-000000
J13, J2–J5, J8	2-position terminal block	On Shore Technology	ED555/2DS
J9	2.5mm power connector	CUI Stack	PJ-102B
J130	BNC connector, female, PC mount	AMP/Tyco	414305-1
J131A, J132A, J21A, J22A	20-pin SMT plug	Samtec	TSM-110-01-L-DV-P
J131B, J132B, J21B, J22B	20-pin SMT socket	Samtec	SSW-110-22-F-D-VS-K
J133A, J23A	10-pin SMT plug	Samtec	TSM-105-01-L-DV-P
J133B, J23B	10-pin SMT socket	Samtec	SSW-105-22-F-D-VS-K
J6	4-pin double row header (2x2) 0.1"	Samtec	TSW-102-07-L-D
J134, J135	12-pin double row header (2x6) 0.1"	Samtec	TSW-106-07-L-D

Table F-1. USB-MODEVM Bill of Materials (continued)

Designators	Description	Manufacturer	Mfr Part Number
JMP1–JMP4	2-position jumper, 0.1" spacing	Samtec	TSW-102-07-L-S
JMP8–JMP14	2-position jumper, 0.1" spacing	Samtec	TSW-102-07-L-S
JMP5, JMP6	3-position jumper, 0.1" spacing	Samtec	TSW-103-07-L-S
JMP7	3-position dual row jumper, 0.1" spacing	Samtec	TSW-103-07-L-D
SW1	SMT, half-pitch 2-position switch	C&K Division, ITT	TDA02H0SK1
SW2	SMT, half-pitch 8-position switch	C&K Division, ITT	TDA08H0SK1
	Jumper plug	Samtec	SNT-100-BK-T

Appendix G USB-MODEVM Protocol

G.1 USB-MODEVM Protocol

The USB-MODEVM is defined to be a Vendor-Specific class, and is identified on the PC system as an NI-VISA device. Because the TAS1020 has several routines in its ROM which are designed for use with HID-class devices, HID-like structures are used, even though the USB-MODEVM is not an HID-class device. Data is passed from the PC to the TAS1020 using the control endpoint.

Data is sent in an HIDSETREPORT (see [Table G-1](#)):

**Table G-1. USB Control Endpoint
HIDSETREPORT Request**

Part	Value	Description
bmRequestType	0x21	00100001
bRequest	0x09	SET_REPORT
wValue	0x00	don't care
wIndex	0x03	HID interface is index 3
wLength	calculated by host	
Data		Data packet as described below

The data packet consists of the following bytes, shown in [Table G-2](#):

Table G-2. Data Packet Configuration

BYTE NUMBER	TYPE	DESCRIPTION
0	Interface	Specifies serial interface and operation. The two values are logically ORed. Operation: READ 0x00 WRITE 0x10 Interface: GPIO 0x08 SPI_16 0x04 I2C_FAST 0x02 I2C_STD 0x01 SPI_8 0x00
1	I ² C Slave Address	Slave address of I ² C device or MSB of 16-bit reg addr for SPI
2	Length	Length of data to write/read (number of bytes)
3	Register address	Address of register for I ² C or 8-bit SPI; LSB of 16-bit address for SPI
4..64	Data	Up to 60 data bytes could be written at a time. EPO maximum length is 64. The return packet is limited to 42 bytes, so advise only sending 32 bytes at any one time.

Example usage:

Write two bytes (AA, 55) to device starting at register 5 of an I²C device with address A0:

```

[ 0 ]    0x11
[ 1 ]    0xA0
[ 2 ]    0x02
[ 3 ]    0x05
[ 4 ]    0xAA
[ 5 ]    0x55
  
```

Do the same with a fast mode I²C device:

```
[ 0]    0x12
[ 1]    0xA0
[ 2]    0x02
[ 3]    0x05
[ 4]    0xAA
[ 5]    0x55
```

Now with an SPI device which uses an 8-bit register address:

```
[ 0]    0x10
[ 1]    0xA0
[ 2]    0x02
[ 3]    0x05
[ 4]    0xAA
[ 5]    0x55
```

Now let's do a 16-bit register address, as found on parts like the TSC2101. Assume the register address (command word) is **0x10E0**:

```
[ 0]    0x14
[ 1]    0x10 --> Note: the I2C address now serves as MSB of reg addr.
[ 2]    0x02
[ 3]    0xE0
[ 4]    0xAA
[ 5]    0x55
```

In each case, the TAS1020 will return, in an HID interrupt packet, the following:

[0] interface byte | status

status:

REQ_ERROR 0x80

INTF_ERROR 0x40

REQ_DONE 0x20

[1] for I²C interfaces, the I²C address as sent

for SPI interfaces, the read back data from SPI line for transmission of the corresponding byte

[2] length as sent

[3] for I²C interfaces, the reg address as sent

for SPI interfaces, the read back data from SPI line for transmission of the corresponding byte

[4..60] echo of data packet sent

If the command is sent with no problem, the returning byte [0] should be the same as the sent one logically ORed with 0x20 - in our first example above, the returning packet should be:

```
[0] 0x31
[1] 0xA0
[2] 0x02
[3] 0x05
[4] 0xAA
[5] 0x55
```

If for some reason the interface fails (for example, the I²C device does not acknowledge), it would come back as:

```
[0] 0x51 --> interface | INTF_ERROR
[1] 0xA0
[2] 0x02
[3] 0x05
[4] 0xAA
[5] 0x55
```

If the request is malformed, that is, the interface byte (byte [0]) takes on a value which is not described above, the return packet would be:

```
[0] 0x93 --> the user sent 0x13, which is not valid, so 0x93 returned
[1] 0xA0
[2] 0x02
[3] 0x05
[4] 0xAA
[5] 0x55
```

Examples above used writes. Reading is similar:

Read two bytes from device starting at register 5 of an I²C device with address A0:

```
[0] 0x01
[1] 0xA0
[2] 0x02
[3] 0x05
```

GPIO Capability

The return packet should be

```
[ 0]    0x21
[ 1]    0xA0
[ 2]    0x02
[ 3]    0x05
[ 4]    0xAA
[ 5]    0x55
```

assuming that the values we wrote above starting at Register 5 were actually written to the device.

G.2 GPIO Capability

The USB-MODEVM has seven GPIO lines. Access them by specifying the interface to be 0x08, and then using the standard format for packets—but addresses are unnecessary. The GPIO lines are mapped into one byte (see [Table G-3](#)):

Table G-3. GPIO Pin Assignments

Bit 7	6	5	4	3	2	1	0
x	P3.5	P3.4	P3.3	P1.3	P1.2	P1.1	P1.0

Example: write P3.5 to a 1, set all others to 0:

```
[ 0]    0x18 --> write, GPIO
[ 1]    0x00 --> this value is ignored
[ 2]    0x01 --> length - ALWAYS a 1
[ 3]    0x00 --> this value is ignored
[ 4]    0x40 --> 01000000
```

The user may also read back from the GPIO to see the state of the pins. Let's say we just wrote the previous example to the port pins.

Example: read the GPIO

```
[ 0]    0x08 --> read, GPIO
[ 1]    0x00 --> this value is ignored
[ 2]    0x01 --> length - ALWAYS a 1
[ 3]    0x00 --> this value is ignored
```

The return packet should be:

```
[ 0]    0x28
[ 1]    0x00
[ 2]    0x01
[ 3]    0x00
[ 4]    0x40
```

G.3 Writing Scripts

A script is simply a text file that contains data to send to the serial control buses. The scripting language is quite simple, as is the parser for the language. Therefore, the program is not very forgiving about mistakes made in the source script file, but the formatting of the file is simple. Consequently, mistakes should be rare.

Each line in a script file is one command. There is no provision for extending lines beyond one line. A line is terminated by a carriage return.

The first character of a line is the command. Commands are:

- I** Set interface bus to use
- r** Read from the serial control bus
- w** Write to the serial control bus
- #** Comment
- b** Break
- d** Delay

The first command, **I**, sets the interface to use for the commands to follow. This command must be followed by one of the following parameters:

i2cstd	Standard mode I ² C Bus
i2cfast	Fast mode I ² C bus
spi8	SPI bus with 8-bit register addressing
spi16	SPI bus with 16-bit register addressing
gpio	Use the USB-MODEVM GPIO capability

For example, if a fast mode I²C bus is to be used, the script would begin with:

I i2cfast

No data follows the break command. Anything following a comment command is ignored by the parser, provided that it is on the same line. The delay command allows the user to specify a time, in milliseconds, that the script will pause before proceeding.

Note: UNLIKE ALL OTHER NUMBERS USED IN THE SCRIPT COMMANDS, THE DELAY TIME IS ENTERED IN A DECIMAL FORMAT. Also, note that because of latency in the USB bus as well as the time it takes the processor on the USB-MODEVM to handle requests, the delay time may not be precise.

A series of byte values follows either a read or write command. Each byte value is expressed in hexadecimal, and each byte must be separated by a space. Commands are interpreted and sent to the TAS1020 by the program using the protocol described in [Section G.1](#).

The first byte following a read or write command is the I²C slave address of the device (if I²C is used) or the first data byte to write (if SPI is used—note that SPI interfaces are not standardized on protocols, so the meaning of this byte will vary with the device being addressed on the SPI bus). The second byte is the starting register address that data will be written to (again, with I²C; SPI varies—see [Section G.1](#) for additional information about what variations may be necessary for a particular SPI mode). Following these two bytes are data, if writing; if reading, the third byte value is the number of bytes to read, (expressed in hexadecimal).

For example, to write the values 0xAA 0x55 to an I²C device with a slave address of 0x90, starting at a register address of 0x03, one would write:

```
#example script
I i2cfast
w 90 03 AA 55
r 90 03 2
```

This script begins with a comment, specifies that a fast I²C bus will be used, then writes 0xAA 0x55 to the I²C slave device at address 0x90, writing the values into registers 0x03 and 0x04. The script then reads back two bytes from the same device starting at register address 0x03. Note that the slave device value does not change. It is not necessary to set the R/W bit for I²C devices in the script; the read or write commands will do that.

Writing Scripts

Here is an example of using an SPI device that requires 16-bit register addresses:

```
# setup TSC2101 for input and output
# uses SPI16 interface
# this script sets up DAC and ADC at full volume, input from onboard mic
#
# Page 2: Audio control registers
w 10 00 00 00 80 00 00 00 45 31 44 FD 40 00 31 C4
w 13 60 11 20 00 00 00 80 7F 00 C5 FE 31 40 7C 00 02 00 C4 00 00 00 23 10 FE
00 FE 00
```

Note that blank lines are allowed. However, be sure that the script does not end with a blank line. While ending with a blank line will not cause the script to fail, the program will execute that line, and therefore, may prevent the user from seeing data that was written or read back on the previous command.

In this example, the first two bytes of each command are the command word to send to the TSC2101 (0x1000, 0x1360); these are followed by data to write to the device starting at the address specified in the command word. The second line may wrap in the viewer being used to look like more than one line; careful examination will show, however, that there is only one carriage return on that line, following the last **00**.

Any text editor may be used to write these scripts; Jedit is an editor that is highly recommended for general usage. For more information, go to: <http://www.jedit.org>.

Once the script is written, it can be used in the command window by running the program, and then selecting *Open Command File...* from the File menu. Locate the script and open it. The script will then be displayed in the command buffer. The user may also edit the script once it is in the buffer, but saving of the command buffer is not possible at this time (this feature may be added at a later date).

Once the script is in the command buffer, it may be executed by pressing the *Execute Command Buffer* button. If there are breakpoints in the script, the script will execute to that point, and the user will be presented with a dialog box with a button to press to continue executing the script. When ready to proceed, push that button and the script will continue.

Here an example of a (partial) script with breakpoints:

```
# setup AIC33 for input and output
# uses I2C interface
I i2cfast
# reg 07 - codec datapath
w 30 07 8A
r 30 07 1
d 1000
# regs 15/16 - ADC volume, unmute and set to 0dB
w 30 0F 00 00
r 30 0F 2
b
```

This script writes the value 8A at register 7, then reads it back to verify that the write was good. A delay of 1000ms (one second) is placed after the read to pause the script operation. When the script continues, the values **00 00** will be written starting at register 0F. This output is verified by reading two bytes, and pausing the script again, this time with a break. The script would not continue until the user allows it to by pressing *OK* in the dialog box that will be displayed due to the break.

EVALUATION BOARD/KIT IMPORTANT NOTICE

Texas Instruments (TI) provides the enclosed product(s) under the following conditions:

This evaluation board/kit is intended for use for **ENGINEERING DEVELOPMENT, DEMONSTRATION, OR EVALUATION PURPOSES ONLY** and is not considered by TI to be a finished end-product fit for general consumer use. Persons handling the product(s) must have electronics training and observe good engineering practice standards. As such, the goods being provided are not intended to be complete in terms of required design-, marketing-, and/or manufacturing-related protective considerations, including product safety and environmental measures typically found in end products that incorporate such semiconductor components or circuit boards. This evaluation board/kit does not fall within the scope of the European Union directives regarding electromagnetic compatibility, restricted substances (RoHS), recycling (WEEE), FCC, CE or UL, and therefore may not meet the technical requirements of these directives or other related directives.

Should this evaluation board/kit not meet the specifications indicated in the User's Guide, the board/kit may be returned within 30 days from the date of delivery for a full refund. **THE FOREGOING WARRANTY IS THE EXCLUSIVE WARRANTY MADE BY SELLER TO BUYER AND IS IN LIEU OF ALL OTHER WARRANTIES, EXPRESSED, IMPLIED, OR STATUTORY, INCLUDING ANY WARRANTY OF MERCHANTABILITY OR FITNESS FOR ANY PARTICULAR PURPOSE.**

The user assumes all responsibility and liability for proper and safe handling of the goods. Further, the user indemnifies TI from all claims arising from the handling or use of the goods. Due to the open construction of the product, it is the user's responsibility to take any and all appropriate precautions with regard to electrostatic discharge.

EXCEPT TO THE EXTENT OF THE INDEMNITY SET FORTH ABOVE, NEITHER PARTY SHALL BE LIABLE TO THE OTHER FOR ANY INDIRECT, SPECIAL, INCIDENTAL, OR CONSEQUENTIAL DAMAGES.

TI currently deals with a variety of customers for products, and therefore our arrangement with the user **is not exclusive.**

TI assumes **no liability for applications assistance, customer product design, software performance, or infringement of patents or services described herein.**

Please read the User's Guide and, specifically, the Warnings and Restrictions notice in the User's Guide prior to handling the product. This notice contains important safety information about temperatures and voltages. For additional information on TI's environmental and/or safety programs, please contact the TI application engineer or visit www.ti.com/esh.

No license is granted under any patent right or other intellectual property right of TI covering or relating to any machine, process, or combination in which such TI products or services might be or are used.

FCC Warning

This evaluation board/kit is intended for use for **ENGINEERING DEVELOPMENT, DEMONSTRATION, OR EVALUATION PURPOSES ONLY** and is not considered by TI to be a finished end-product fit for general consumer use. It generates, uses, and can radiate radio frequency energy and has not been tested for compliance with the limits of computing devices pursuant to part 15 of FCC rules, which are designed to provide reasonable protection against radio frequency interference. Operation of this equipment in other environments may cause interference with radio communications, in which case the user at his own expense will be required to take whatever measures may be required to correct this interference.

EVM WARNINGS AND RESTRICTIONS

It is important to operate this EVM within the input voltage range of 3.3 V to 5 V and the output voltage range of 0 V to 5 V.

Exceeding the specified input range may cause unexpected operation and/or irreversible damage to the EVM. If there are questions concerning the input range, please contact a TI field representative prior to connecting the input power.

Applying loads outside of the specified output range may result in unintended operation and/or possible permanent damage to the EVM. Please consult the EVM User's Guide prior to connecting any load to the EVM output. If there is uncertainty as to the load specification, please contact a TI field representative.

During normal operation, some circuit components may have case temperatures greater than 30°C. The EVM is designed to operate properly with certain components above 85°C as long as the input and output ranges are maintained. These components include but are not limited to linear regulators, switching transistors, pass transistors, and current sense resistors. These types of devices can be identified using the EVM schematic located in the EVM User's Guide. When placing measurement probes near these devices during operation, please be aware that these devices may be very warm to the touch.

Mailing Address: Texas Instruments, Post Office Box 655303, Dallas, Texas 75265
Copyright © 2007, Texas Instruments Incorporated

IMPORTANT NOTICE

Texas Instruments Incorporated and its subsidiaries (TI) reserve the right to make corrections, modifications, enhancements, improvements, and other changes to its products and services at any time and to discontinue any product or service without notice. Customers should obtain the latest relevant information before placing orders and should verify that such information is current and complete. All products are sold subject to TI's terms and conditions of sale supplied at the time of order acknowledgment.

TI warrants performance of its hardware products to the specifications applicable at the time of sale in accordance with TI's standard warranty. Testing and other quality control techniques are used to the extent TI deems necessary to support this warranty. Except where mandated by government requirements, testing of all parameters of each product is not necessarily performed.

TI assumes no liability for applications assistance or customer product design. Customers are responsible for their products and applications using TI components. To minimize the risks associated with customer products and applications, customers should provide adequate design and operating safeguards.

TI does not warrant or represent that any license, either express or implied, is granted under any TI patent right, copyright, mask work right, or other TI intellectual property right relating to any combination, machine, or process in which TI products or services are used. Information published by TI regarding third-party products or services does not constitute a license from TI to use such products or services or a warranty or endorsement thereof. Use of such information may require a license from a third party under the patents or other intellectual property of the third party, or a license from TI under the patents or other intellectual property of TI.

Reproduction of TI information in TI data books or data sheets is permissible only if reproduction is without alteration and is accompanied by all associated warranties, conditions, limitations, and notices. Reproduction of this information with alteration is an unfair and deceptive business practice. TI is not responsible or liable for such altered documentation. Information of third parties may be subject to additional restrictions.

Resale of TI products or services with statements different from or beyond the parameters stated by TI for that product or service voids all express and any implied warranties for the associated TI product or service and is an unfair and deceptive business practice. TI is not responsible or liable for any such statements.

TI products are not authorized for use in safety-critical applications (such as life support) where a failure of the TI product would reasonably be expected to cause severe personal injury or death, unless officers of the parties have executed an agreement specifically governing such use. Buyers represent that they have all necessary expertise in the safety and regulatory ramifications of their applications, and acknowledge and agree that they are solely responsible for all legal, regulatory and safety-related requirements concerning their products and any use of TI products in such safety-critical applications, notwithstanding any applications-related information or support that may be provided by TI. Further, Buyers must fully indemnify TI and its representatives against any damages arising out of the use of TI products in such safety-critical applications.

TI products are neither designed nor intended for use in military/aerospace applications or environments unless the TI products are specifically designated by TI as military-grade or "enhanced plastic." Only products designated by TI as military-grade meet military specifications. Buyers acknowledge and agree that any such use of TI products which TI has not designated as military-grade is solely at the Buyer's risk, and that they are solely responsible for compliance with all legal and regulatory requirements in connection with such use.

TI products are neither designed nor intended for use in automotive applications or environments unless the specific TI products are designated by TI as compliant with ISO/TS 16949 requirements. Buyers acknowledge and agree that, if they use any non-designated products in automotive applications, TI will not be responsible for any failure to meet such requirements.

Following are URLs where you can obtain information on other Texas Instruments products and application solutions:

Products		Applications	
Amplifiers	amplifier.ti.com	Audio	www.ti.com/audio
Data Converters	dataconverter.ti.com	Automotive	www.ti.com/automotive
DSP	dsp.ti.com	Broadband	www.ti.com/broadband
Interface	interface.ti.com	Digital Control	www.ti.com/digitalcontrol
Logic	logic.ti.com	Military	www.ti.com/military
Power Mgmt	power.ti.com	Optical Networking	www.ti.com/opticalnetwork
Microcontrollers	microcontroller.ti.com	Security	www.ti.com/security
RFID	www.ti-rfid.com	Telephony	www.ti.com/telephony
Low Power Wireless	www.ti.com/lpw	Video & Imaging	www.ti.com/video
		Wireless	www.ti.com/wireless

Mailing Address: Texas Instruments, Post Office Box 655303, Dallas, Texas 75265
Copyright © 2007, Texas Instruments Incorporated