

TINI Q-G® MINIATURE CONNECTORS

- Series TA(*)F, TA(*)FB, TA(*)FL and TA(*)FLB** - Straight female cord plug
- Series TA(*)M, TA(*)MB, TA(*)ML and TA(*)MLB** - Straight male cord plug
- Series TB(*)M and TB(*)MB** - Chassis/panel mount male receptacle
- Series TY(*)F and TY(*)FPC** - Chassis/panel, female receptacle, choice of solder lugs or P.C. terminations.
- Series TLP** - Looping Plugs
- Series TBA(*)*** - Audio Adapters
- Series TRA(*)M** - PC Mount Male Receptacles



Receptacle Series	Panel Mounting		Termination	
	Front	Rear	P.C.	Solder
TB(*)M	X		X ¹	X
TY(*)F	X	X		X
TY(*)FPC	X	X	X	
TRA(*)M		X	X	

¹ P.C. board termination is recommended alternate method

MICROPHONES

Ideal for live performances, recording sessions, and audio pickups. Available in black chrome finish for use on camera or where reflected light is a problem. Disconnecting plugs from lavalier or clip-on mikes is quick and easy...press the release button and pull the plug free. Either shielded or unshielded cables can be used up to 0.115 inches (2.92 mm) in diameter (standard). Cable shield may either be connected to a pin/contact through circuit or may be connected to the cable clamp strain relief. This alternate connection permits using the metal housings of plugs to completely shield internal connections and pins/contacts.

DESIGN FEATURES

STYLE - Streamlined, miniaturized with nickel-plated metal and contrasting black plastic parts. Designed for light weight and unobtrusiveness. Also available in conductive black chrome finish.

CONSTRUCTION - Metal parts are rugged die-cast or precision machined with nickel-plating; plastic parts are molded of high dimensional-stability thermoplastic. Advanced design assures minimum weight consistent with strength and durability of cord plug housings of .413 inch (10.5 mm) diameter. Weight: Series TA(*)F plug = .25 ounce (7 g); Series TA(*)M = .3 ounce (8.5 g).

INSERTS - Precision molded of thermoplastic for high mechanical and dielectric strength. Contacts and terminals are precision formed and plated for intimate contact and low resistance connections. Terminal numbers are molded on rear of male insert and on face of female insert for easy identification (except 6-pin male insert). Inserts can be supplied for OEM installation in microphones and instrumentation for optimum connecting reliability. For cord plugs, inserts can also be supplied for replacements.

LATCHLOCK - Positive latch system assures high integrity, vibration-resistant mating and transfer of shielding connection between housing, combined with simple, easy fingertip release.

STRAIN RELIEF - Rugged internal clamp holds cable tightly, while making a secure, low resistance connection between cable shield and housing.

FLEX RELIEF - Protects by minimizing cable bending stress at point of cable entry. Maximum recommended cable diameter is .115 inch (2.92 mm) when flex relief is used. By omitting flex relief (Series T(*)FL and T(*)ML only), cable up to .170 inch (4.32 mm) diameter can be used.

INSTRUMENTATION

Tini Q-G® plugs and receptacles have the quality and versatility of functions and features for the most demanding compact connections in industrial, R and D and production instrumentation of all kinds. The 4, 5, and 6-pin/contact versions are especially suited to multi-circuit connections.

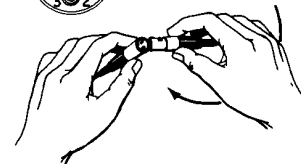
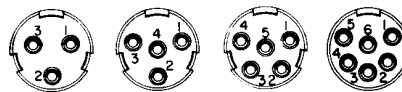

ASSEMBLY - Connector parts are mechanically keyed for simple assembly.

POLARIZATION - Mating male and female connectors are also mechanically keyed (latch and groove) so that it is impossible to mate them incorrectly.

“SCOOP-PROOF” FEATURE - Fully recessed pins on male plugs and receptacles cannot be “scooped”, bent or damaged by accidental mismatching with mating connector.

COLOR ESCUTCHEONS - Attractive color escutcheons, Series TYEF, are recommended for use with Series TY(*)F and TY(*)FPC receptacles (when rear mounted) for attractive panel trim, as well as color coding one or more connectors. Colors are: red, black, gray, green, blue, white and yellow.

CUSTOM Tini Q-G® CABLE ASSEMBLIES

On special order where production quantities warrant, Switchcraft can supply assembled and tested Tini Q-G® cables.

MOUNTING

Panel/Chassis Thickness:

Series TB(*)M: .25 inch (6.35 mm) maximum

Series TY(*)F:

Front—.375 inch (9.5 mm) maximum

Rear—.093 inch (2.3 mm) maximum

Series TY(*)FPC:

Front—.312 inch (7.9 mm) maximum

Rear—.093 inch (2.3 mm) maximum

DIMENSIONS ARE FOR REFERENCE ONLY $\frac{\text{Inch}}{\text{(mm)}}$

NOTE: Contact your Switchcraft Representative for price and delivery.

TINI Q-G® MINIATURE CONNECTORS (continued)

SPECIFICATIONS: (all Tini QG, except 6 pin)

ELECTRICAL

Contact Resistance: .010 ohms maximum after life (and after salt spray).

Current Rating (Carry Only): 5 A, 125 V AC (4 A, 125 V AC on 5 circuit) based on 30°C maximum.

Insulation Resistance: 510,000 megohms minimum @ 500 V DC (initial); 10,000 megohms minimum (after humidity test).

Dielectric Strength: 1,000 V (rms).

MECHANICAL

Life: 5,000 operations minimum

Insertion/Withdrawal Forces (after life): 6.1 lb./2.77 kg after life, insertion; 5.6 lb/2.54 kg, withdrawal.

Solderability Standard: Meets EIA RS-186-9E.

Mechanical Shock: Meets MIL-STD-202, method 213B.

Vibration: Meets MIL-STD-202, method 201A.

Wire Size: #22 wire gauge solid; #24 wire gauge stranded.

ENVIRONMENTAL

Thermal Range: -55°C to + 85°C.

Humidity: Meets MIL-STD-202, method 106D.

Thermal Shock: Meets MIL-STD-202, method 107D.

Salt Spray: Meets MIL-STD-202, method 101.

MATERIAL

Housing, Plugs and Male Receptacles: Brass, nickel-plated.

Female Receptacle—Die-cast zinc, nickel-plated.

Black Tini Q-G® Housing: Brass, black chrome-plated.

Pin and Socket Contacts: Copper alloy, silver-plated.

Flex Relief: Molded black thermoplastic elastomer.

Latch Button: Molded black thermoplastic.

Release Lever and Mounting Washer: Steel, nickel-plated.

Standoff/Ground Terminal and Cable Clamp: Steel, electroplated.

Inserts and Insulating Spacer: Molded, high strength thermoplastic.

Latch (Female): Beryllium copper, nickel-plated.

Mounting Nut: Brass, nickel-plated.

SPECIFICATIONS: (6 Pin Plugs, Receptacles and Adapters)

ELECTRICAL

Contact Resistance: .010 ohm maximum after life.

Current Rating (Carry only): 1.5A, 125 VAC, based on 30° maximum

Insulation Resistance: 510,000 MΩ minimum @ 500 VDC (initial).

Dielectric Strength: 250 V rms.

MECHANICAL

Life: 2,000 operations

Insertion/Withdrawal Forces (after life): —13 pound insertion; —13 pound maximum withdrawal

Solderability Standard: Meets EIA RS-186-9E.

Wire Size: 28 wire gauge stranded.

MATERIAL

Housings, Plugs and Male Receptacles: Brass, nickel-plated.

Socket Contacts: Copper alloy, silver-plated.

Pin Contacts: Copper alloy, electroplated.

Flex Relief and Latch Button: Molded thermoplastic.

Ground Terminal: Beryllium copper, electroplated.

Inserts and Insulating Spacer: Molded high strength thermoplastic, UL 94 V-0.

Latch (Female): Beryllium copper, nickel-plated.

Mounting Nut: Brass, nickel-plated.

Ferrite: 43 material, shielded head.

Frame: Molded thermoplastic, UL 94 V-0.

TINI Q-G® CONNECTOR PART NUMBERING SYSTEM

Series	Number of Contacts	Gender	Options
TA CORD PLUG	3	M MALE	B BLACK CHROME FINISH
TB FRONT PANEL MOUNT USING NUT (MALE ONLY)	4	F FEMALE	L LARGE HANDLE
TRA RIGHT ANGLE PC/REAR PANEL MOUNT (MALE ONLY)	5		AU GOLD CONTACTS
TY FRONT/REAR PANEL MOUNT (FEMALE ONLY)	6		
OPTIONS SHOWN IN ORDER OF APPEARANCE			

NOTE 1:

1. TRA SERIES AVAILABLE IN 3 AND 6 PIN VERSIONS ONLY.
2. TY SERIES AVAILABLE IN 3, 4, AND 5 PIN VERSIONS ONLY

DIMENSIONS ARE FOR REFERENCE ONLY $\frac{\text{Inch}}{\text{(mm)}}$

NOTE: Contact your Switchcraft Representative for price and delivery.

TA(*)F, TA(*)FL AND TA(*)FB CORD PLUG

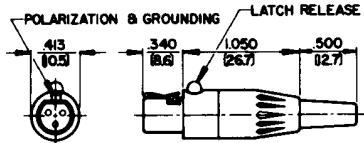
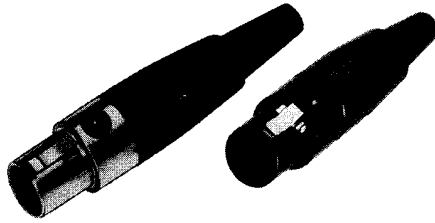

STRAIGHT FEMALE CORD PLUG

Part Number	Insert Contacts	Part Number	Insert Contacts
TA3F	3	TA4FL ¹	4
TA3FB	3	TA4FLB*	4
TA3FL ¹	3	TA5F	5
TA3FLB	3	TA5FL ¹	5
TA4F	4	TA5FLB*	5
TA4FB	4	◇TA6FL ¹	6

¹ Flex relief omitted for larger diameter cable
* B indicates black housing

TA(*)M, TA(*)MB, TA(*)ML AND TA(*)MLB CORD PLUG

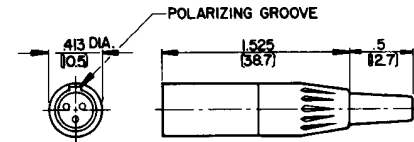
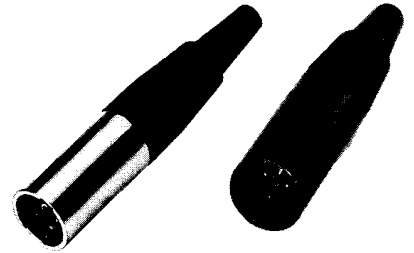

STRAIGHT MALE CORD PLUG

Part Number	Insert Pins	Part Number	Insert Pins
TA3M	3	TA4ML ¹	4
TA3MB*	3	TA5M	5
TA3ML	3	TA5ML	5
TA4M	4	TA5MLB*	5
TA4MB*	4	◇TA6ML ¹	6

* B indicates black housing

TB(*)M AND TB(*)MB RECEPTACLE

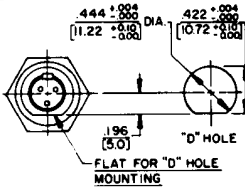
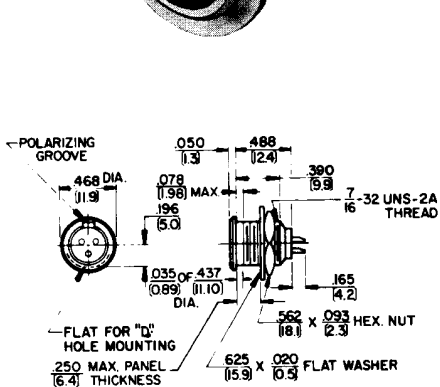
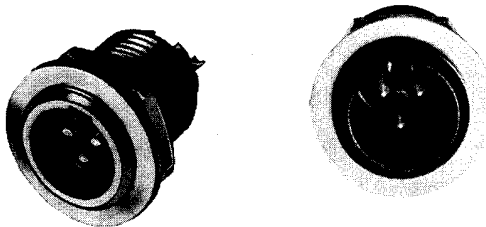

Part Number	Insert Pins	Part Number	Insert Pins
TB3M	3	TB5M	5
TB3MB*	3	TB5MB*	5
TB4M	4	◇TB6M	6
TB4MB*	4		

* B indicates black housing

Male receptacle for chassis/panel mounting. Specially designed flange permits close (front) mount on crowded panels. Mounting hardware supplied.

TLP(*) LOOPING PLUG

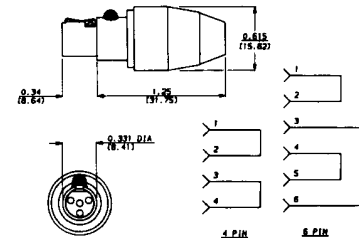
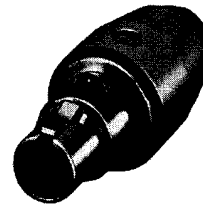

Looping plug is designed for circuit testing. Other inserts and wiring patterns are possible; contact Switchcraft.

STRAIGHT FEMALE LOOPING PLUG

Part Number	Insert Contacts
◇TLP4	4
◇TLP6	6

◇ Available on special order only; contact Switchcraft for price and delivery.
* Number of insert contacts or pins must be specified to complete Part Number.

DIMENSIONS ARE FOR REFERENCE ONLY Inch
(mm)

NOTE: Contact your Switchcraft Representative for price and delivery.

TINI Q-G® MINIATURE CONNECTORS (continued)



TRA(*)M PC MOUNT MALE RECEPTACLE

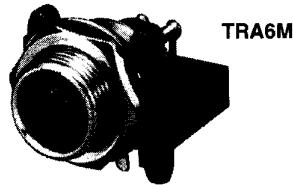
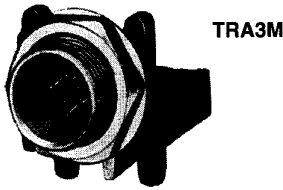

The TRA(*)M low profile male receptacles mount in minimum space from the rear of panel or chassis, and feature space-saving right-angle construction and PC type terminals. The TRA3M is a cost-effective choice for audio equipment, medical instrumentation, computer equipment and test/measurement applications. Also available with 6 pins.

Part Number	Insert Pins
TRA3M	3
◇TRA6M	6
◇TRA6MF*	6

*F designates ferrite shielding.

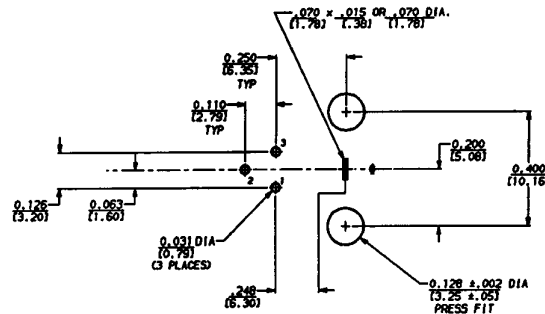
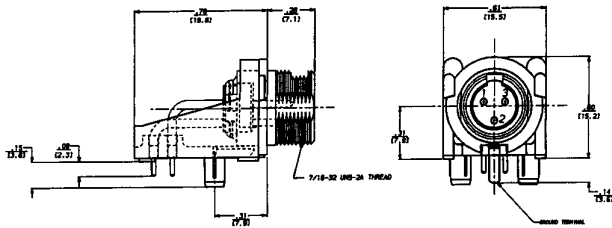

TINI Q-G® AUDIO ADAPTERS

Series TA Tini Q-G® audio adapters have been designed to adapt Tini Q-G® connections to standard audio connectors. Tini Q-G® adapters convert to Switchcraft Q-G® and QGP connectors and similar full-size connectors.

Part Number	Tini Q-G® End Mates With	Q-G® End Mates With
◇TA-01	TA3F	A3M
◇TA-02	TA4F	A4M
◇TA-03	TA5F	A5M
◇TA-04	TA3F	A3F
◇TA-05	TA4F	A4F
◇TA-06	TA5F	A5F

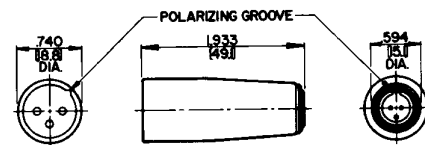
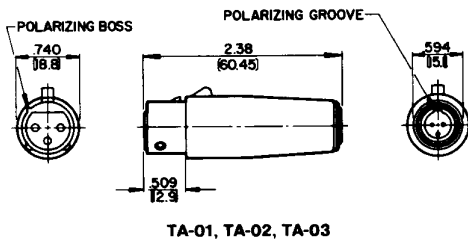
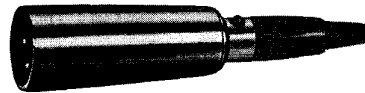
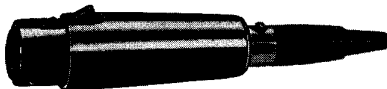

◇ Available on special order only; contact Switchcraft for price and delivery.

DIMENSIONS ARE FOR REFERENCE ONLY $\frac{\text{Inch}}{\text{(mm)}}$

NOTE: Contact your Switchcraft Representative for price and delivery.

CONNECTORS AND RECEPTACLES

TINI Q-G® MINIATURE CONNECTORS (continued)



TA(*)F AND TY(*)FPC RECEPTACLES

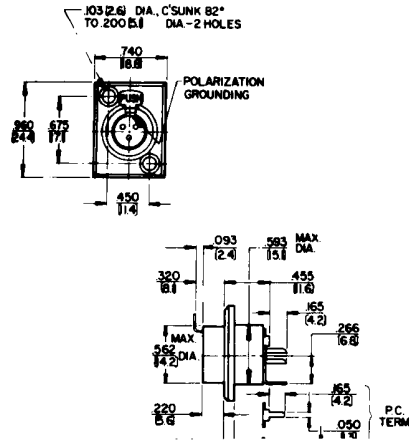

Female receptacle mounts in minimum space from front or rear panel or chassis. Terminals are solder lugs, Series TY(*)F, or P.C., Series TY(*)FPC. All receptacles have separate ground lug.

Part Number	Insert Contacts	Part Number	Insert Contacts
TY3F	3	TY5F	5
TY3FPC	3	TY5FPC	5
TY4F	4		
TY4FPC	4		

MOUNTING HOLE DETAIL

SERIES TY(*)F, TY(*)FPC

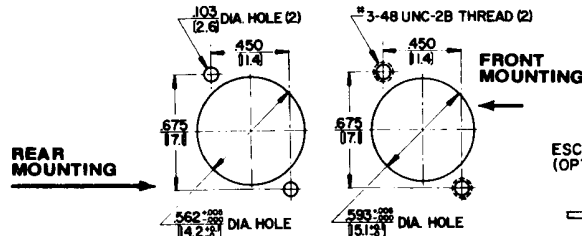

COMBINED P.C./PANEL MOUNTING

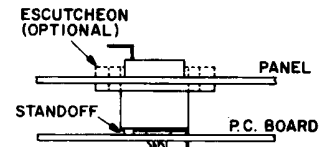

RECOMMENDED P.C. BOARD LAYOUT

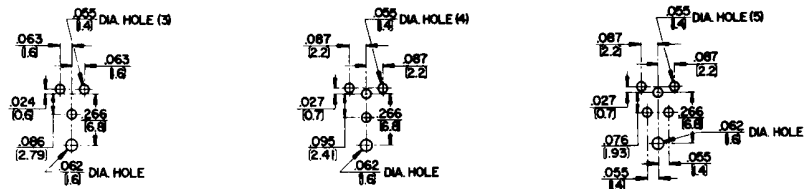

TQG(*)F AND TQG(*)M CONNECTOR INSERTS

TBA(**) AUDIO ADAPTER

TYEF ESCUTCHEONS

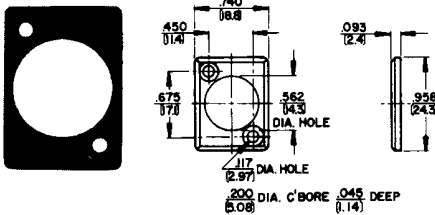

Trim escutcheons in seven colors for use with Series TY(*)F and TY(*)FPC receptacles, are recommended for rear mount receptacles. Escutcheons must be ordered separately.

Part Number	Color
◇TYEF01	Red
TYEF02	Black
◇TYEF03	Green
◇TYEF04	Blue
◇TYEF05	White
◇TYEF08	Yellow
◇TYEF11	Gray



Male and female inserts with 3, 4, 5 or 6 pins/ contacts. For replacement (cord plugs only) or build-into equipment, such as microphones, transducers and instruments.

Male Inserts

Part Number	Insert Pins
TQG3M	3
TQG4M	4
TQG5M	5
◇TQG6M	6

Female Inserts

Part Number	Insert Contacts
TQG3F	3
TQG4F	4
TQG5F	5
◇TQG6F	6

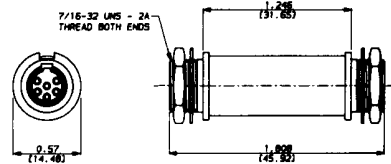
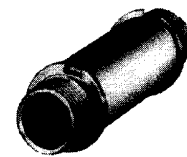

3-6 pin male-to-male adapter is designed for through-bulkhead or cable expansion usage. Adapter is prewired pin 1 to pin 1, pin 2 to pin 2, etc. Mounting nuts are supplied for each threaded end. Panel hole diameter required is .45 inch; maximum panel thickness is .25 inch (6.35 mm).

Part Number	Insert Pins
◇TBA03	3
◇TBA04	4
◇TBA05	5
◇TBA06	6

◇ Available on special order only; contact Switchcraft for price and delivery.

DIMENSIONS ARE FOR REFERENCE ONLY Inch
(mm)

NOTE: Contact your Switchcraft Representative for price and delivery.