

4 x 45 W quad bridge car radio amplifier

Datasheet - production data

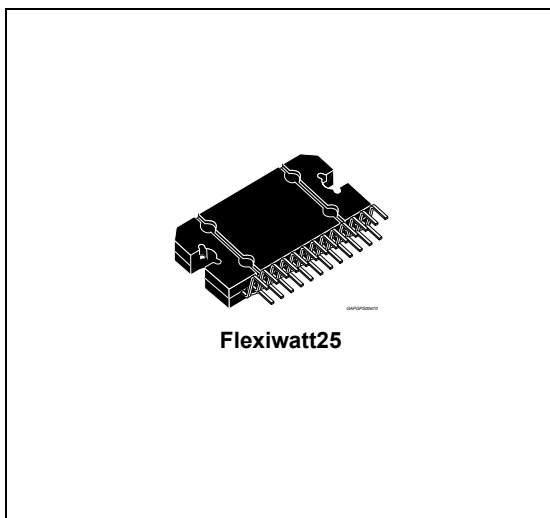

- Low external component count:
 - Internally fixed gain (26 dB)
 - No external compensation
 - No bootstrap capacitors

Protections:

- Output short circuit to gnd, to V_S , across the load
- Very inductive loads
- Overrating chip temperature with soft thermal limiter
- Load dump voltage
- Fortuitous open GND
- Reversed battery
- ESD

Features

- High output power capability:
 - 4 x 45 W / 4 Ω max.
 - 4 x 26 W / 4 Ω @ 14.4 V, 1 kHz, 10 %
- Low distortion
- Low output noise
- Standby function
- Mute function
- Automute at min. supply voltage detection

Description

The TDA7388 is an AB class audio power amplifier, packaged in Flexiwatt 25 and designed for high end car radio applications.

Based on a fully complementary PNP/NPN configuration, the TDA7388 allows a rail to rail output voltage swing with no need of bootstrap capacitors. The extremely reduced boundary components count allows very compact sets.

Table 1. Device summary

Order code	Package	Packing
TDA7388	Flexiwatt25	Tube

Contents

1	Pin connection and test/application diagrams	5
2	Electrical specifications	6
2.1	Absolute maximum ratings	6
2.2	Thermal data	6
2.3	Electrical characteristics	7
2.4	Electrical characteristic curves	8
3	Application hints	10
3.1	SVR	10
3.2	Input stage	10
3.3	Standby and muting	10
4	Package information	11
5	Revision history	12

List of tables

Table 1.	Device summary	1
Table 2.	Absolute maximum ratings	6
Table 3.	Thermal data.	6
Table 4.	Electrical characteristics	7
Table 5.	Document revision history	12

List of figures

Figure 1.	Pin connection (top view)	5
Figure 2.	Standard test and application circuit	5
Figure 3.	Quiescent current vs. supply voltage	8
Figure 4.	Output power vs. supply voltage (4 Ohm)	8
Figure 5.	Distortion vs. output power (4 Ohm)	8
Figure 6.	Distortion vs. frequency (4 Ohm)	8
Figure 7.	Supply voltage rejection vs. frequency	8
Figure 8.	Crosstalk vs. frequency	8
Figure 9.	Output noise vs. source resistance	9
Figure 10.	Total power disipation & efficiency (4 Ohm, sine)	9
Figure 11.	Power dissipation vs. average output power (4 Ohm, audio program simulation)	9
Figure 12.	ITU R-ARM frequency response, weighting filter for transient pop	9
Figure 13.	Flexiwatt25 mechanical data and package dimensions	11

1 Pin connection and test/application diagrams

Figure 1. Pin connection (top view)

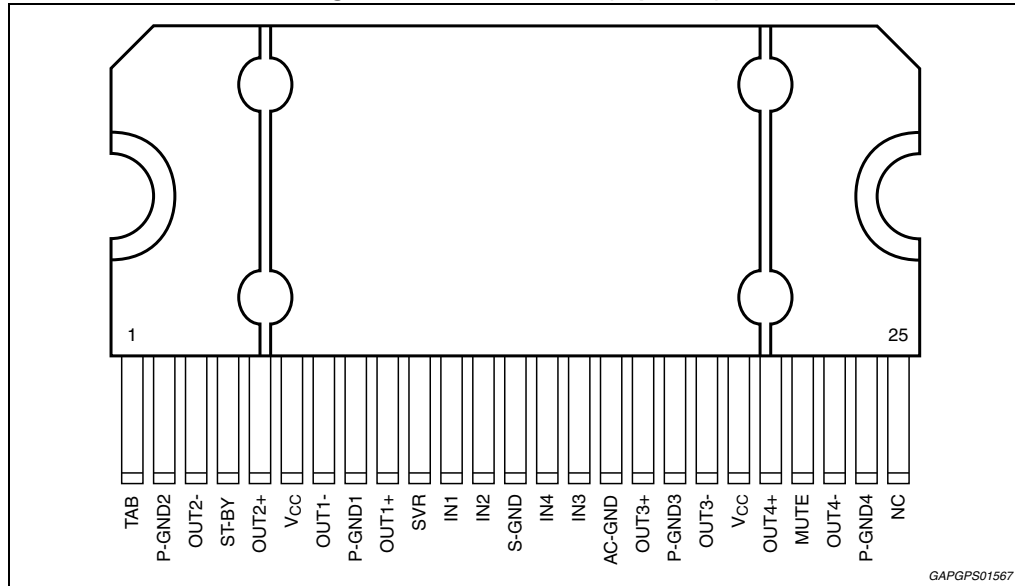
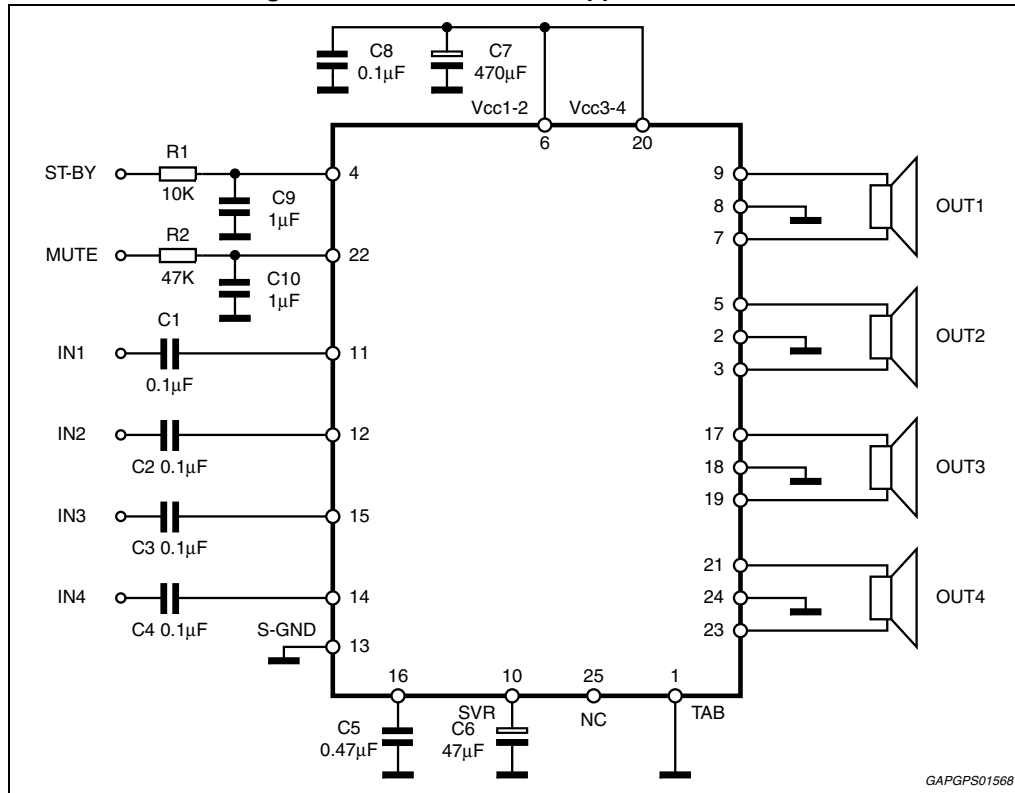

Figure 2. Standard test and application circuit



2 Electrical specifications

2.1 Absolute maximum ratings

Table 2. Absolute maximum ratings

Symbol	Parameter	Value	Unit
V_S	Operating supply voltage	18	V
$V_{S(DC)}$	DC supply voltage	28	V
$V_{S(pk)}$	Peak supply voltage (t = 50 ms)	50	V
I_O	Output peak current: Repetitive (duty cycle 10 % at f = 10 Hz)	4.5	A
	Non repetitive (t = 100 μ s)	5.5	
P_{tot}	Power dissipation, ($T_{case} = 70\text{ }^\circ\text{C}$)	80	W
T_j	Junction temperature	150	$^\circ\text{C}$
T_{stg}	Storage temperature	- 55 to 150	$^\circ\text{C}$

2.2 Thermal data

Table 3. Thermal data

Symbol	Parameter	Value	Unit
$R_{th\ j-case}$	Thermal resistance junction-to-case max.	1	$^\circ\text{C/W}$

2.3 Electrical characteristics

$V_S = 14.4\text{ V}$; $f = 1\text{ kHz}$; $R_g = 600\ \Omega$; $R_L = 4\ \Omega$; $T_{amb} = 25\text{ °C}$; Refer to the test and application diagram (Figure 2), unless otherwise specified.

Table 4. Electrical characteristics

Symbol	Parameter	Test condition	Min.	Typ.	Max.	Unit
I_{q1}	Quiescent current	$R_L = \infty$	120	190	350	mA
V_{OS}	Output offset voltage	Play mode	-	-	± 100	mV
dV_{OS}	During mute ON/OFF output offset voltage	ITU R-ARM weighted see Figure 12	-80	-	+80	mV
G_V	Voltage gain	-	25	26	27	dB
P_o	Output power	THD = 10 %; $V_S = 14.4\text{ V}$	22	26	-	W
$P_{o\ max}$	Max.output power ⁽¹⁾	$V_S = 14.4\text{ V}$	37	41	-	W
		$V_S = 15.2\text{ V}$	-	45	-	
THD	Distortion	$P_o = 4\text{ W}$	-	0.04	0.15	%
e_{No}	Output noise	"A" Weighted	-	50	70	μV
		Bw = 20 Hz to 20 kHz	-	70	100	μV
SVR	Supply voltage rejection	$f = 100\text{ Hz}$; $V_r = 1\text{ Vrms}$	50	65	-	dB
f_{ch}	High cut-off frequency	$P_o = 0.5\text{ W}$	100	200	-	kHz
R_i	Input Impedance	-	70	100	-	$k\Omega$
C_T	Cross talk	$f = 1\text{ kHz}$; $P_o = 4\text{ W}$	60	70	-	dB
		$f = 10\text{ kHz}$; $P_o = 4\text{ W}$	-	60	-	dB
I_{SB}	Standby current consumption	$V_{St-by} = 0\text{ V}$	-	-	20	μA
$V_{SB\ out}$	Standby OUT threshold voltage	(Amp: ON)	3.5	-	-	V
$V_{SB\ in}$	Standby IN threshold voltage	(Amp: OFF)	-	-	1.5	V
A_M	Mute attenuation	$P_{Oref} = 4\text{ W}$	80	90	-	dB
$V_{M\ out}$	Mute OUT threshold voltage	(Amp: play)	3.5	-	-	V
$V_{M\ in}$	Mute IN threshold voltage	(Amp: mute)	-	-	1.5	V
$V_{AM\ in}$	V_S automute threshold	(Amp: mute); Att. $\geq 80\text{ dB}$; $P_{Oref} = 4\text{ W}$ (Amp: play); Att. $< 0.1\text{ dB}$; $P_o = 0.5\text{ W}$	-	7.6	6.5 8.5	V
I_{pin22}	Muting pin current	$V_{MUTE} = 1.2\text{ V}$ (Source current)	5	11	20	μA

1. Saturated square wave output.

2.4 Electrical characteristic curves

Figure 3. Quiescent current vs. supply voltage

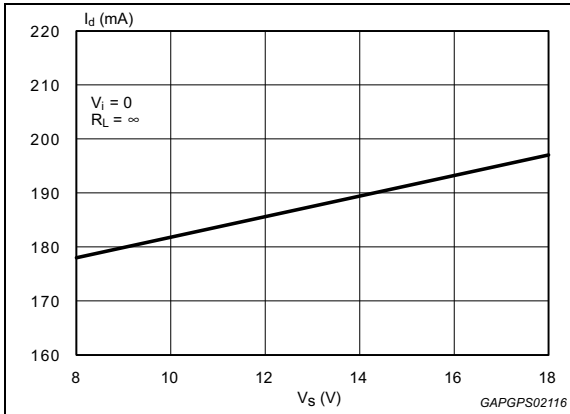

Figure 4. Output power vs. supply voltage (4 Ohm)

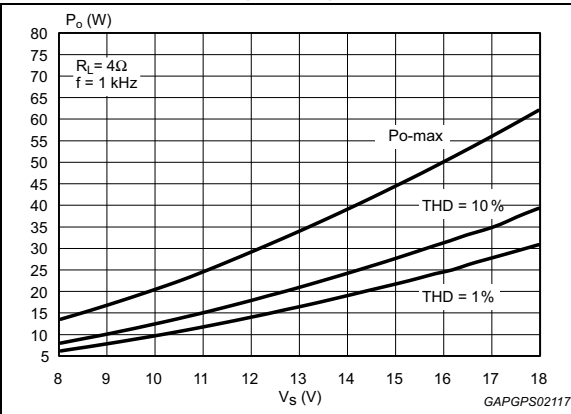

Figure 5. Distortion vs. output power (4 Ohm)

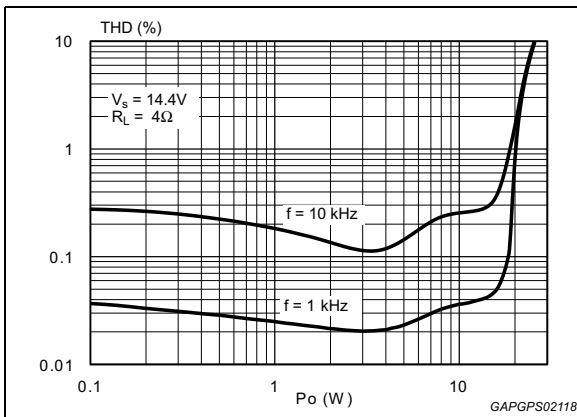

Figure 6. Distortion vs. frequency (4 Ohm)

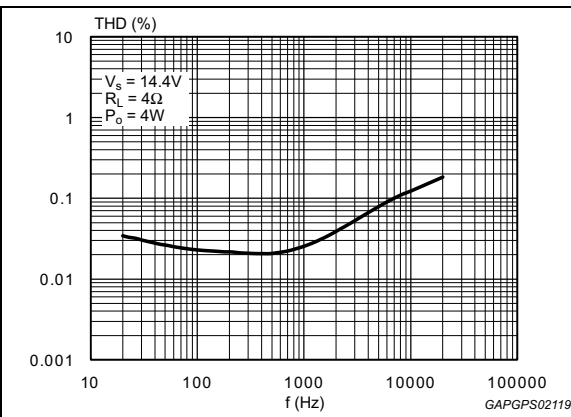

Figure 7. Supply voltage rejection vs. frequency

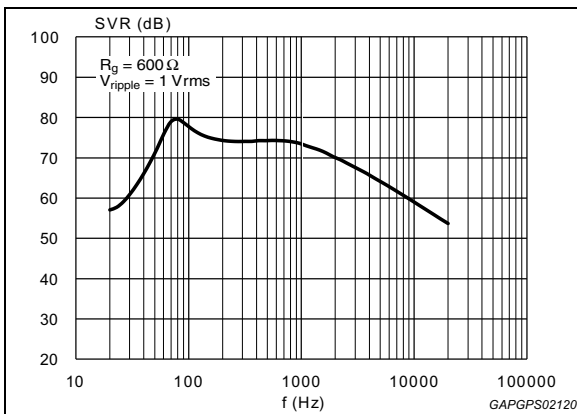

Figure 8. Crosstalk vs. frequency

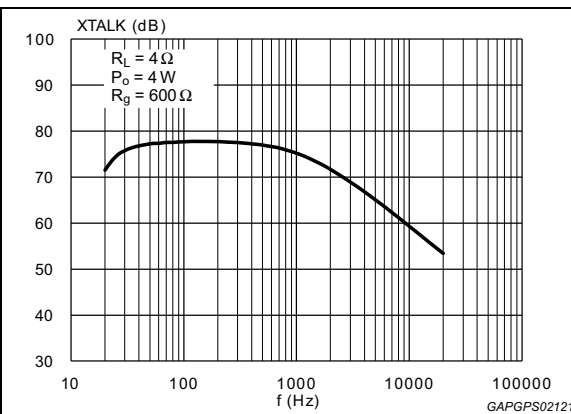

Figure 9. Output noise vs. source resistance

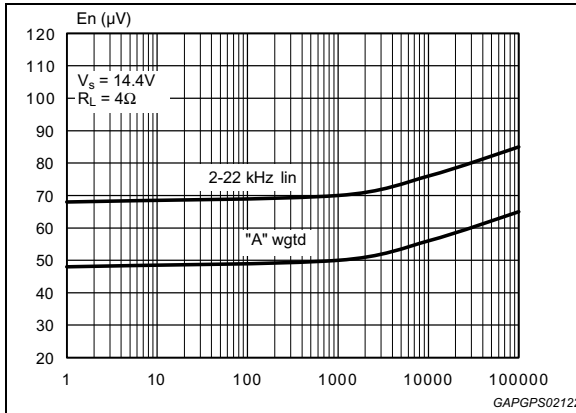

Figure 10. Total power dissipation & efficiency (4 Ohm, sine)

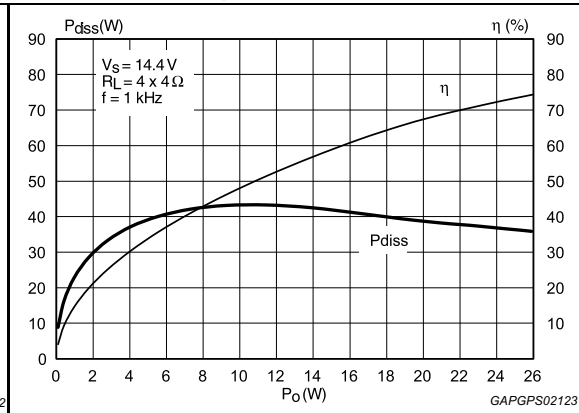

Figure 11. Power dissipation vs. average output power (4 Ohm, audio program simulation)

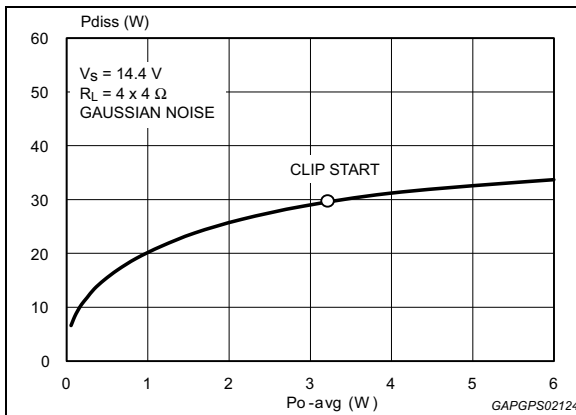
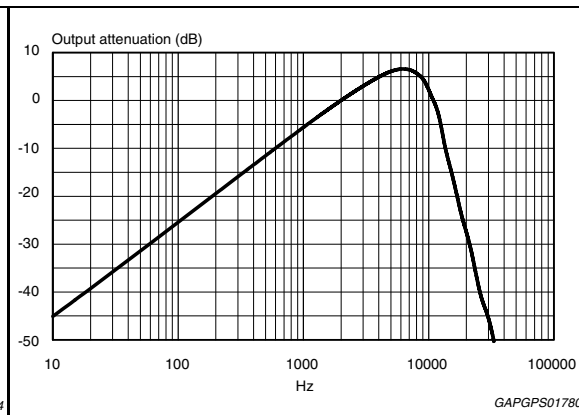

Figure 12. ITU R-ARM frequency response, weighting filter for transient pop



3 Application hints

Ref. to the circuit of [Figure 2](#).

3.1 SVR

Besides its contribution to the ripple rejection, the SVR capacitor governs the turn ON/OFF time sequence and, consequently, plays an essential role in the pop optimization during ON/OFF transients.

To conveniently serve both needs, **its minimum recommended value is 10 μF** .

3.2 Input stage

The TDA7388's inputs are ground-compatible and can stand very high input signals (± 8 Vpk) without any performances degradation.

If the standard value for the input capacitors (0.1 μF) is adopted, the low frequency cut-off amounts to 16 Hz.

3.3 Standby and muting

If standby and muting are not used, a straight connection to V_S of their respective pins would be admissible.

Conventional/low-power transistors can be employed to drive muting and standby pins in absence of true CMOS ports or microprocessors. R-C cells have always to be used in order to smooth down the transitions for preventing any audible transient noises.

Since a DC current of about 10 μA normally flows out of pin 22, the maximum allowable muting-series resistance (R_2) is 70 k Ω , which is sufficiently high to permit a muting capacitor reasonably small (about 1 μF).

If R_2 is higher than recommended, the involved risk is that the voltage at pin 22 may rises to above the 1.5 V threshold voltage and the device consequently fails to turn OFF when the mute line is brought down.

About the stand-by, the time constant to be assigned in order to obtain a virtually pop-free transition has to be slower than 2.5 V/ms.

4 Package information

In order to meet environmental requirements, ST offers these devices in different grades of ECOPACK® packages, depending on their level of environmental compliance. ECOPACK® specifications, grade definitions and product status are available at: www.st.com.

ECOPACK® is an ST trademark.

Figure 13. Flexiwatt25 mechanical data and package dimensions

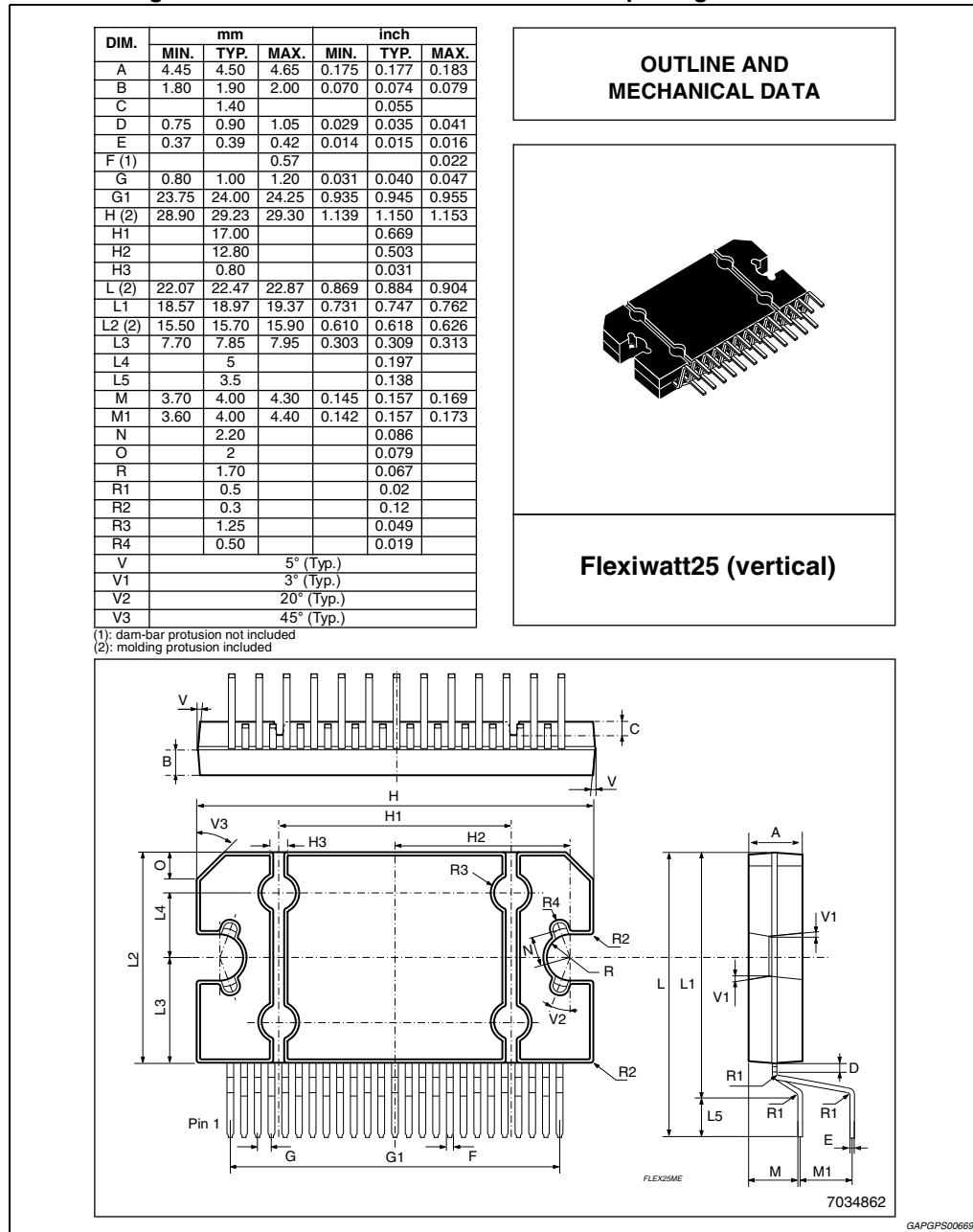

5 Revision history

Table 5. Document revision history

Date	Revision	Changes
06-Dec-2007	1	Initial release.
12-Jul-2010	2	Document status promoted from preliminary data to datasheet.
26-Apr-2012	3	Modified Features on page 1 . Updated Table 4: Electrical characteristics on page 7 .
20-Jun-2012	4	Updated Section 3.3: Standby and muting .
11-Mar-2013	5	Added Section 2.4: Electrical characteristic curves .

Please Read Carefully:

Information in this document is provided solely in connection with ST products. STMicroelectronics NV and its subsidiaries ("ST") reserve the right to make changes, corrections, modifications or improvements, to this document, and the products and services described herein at any time, without notice.

All ST products are sold pursuant to ST's terms and conditions of sale.

Purchasers are solely responsible for the choice, selection and use of the ST products and services described herein, and ST assumes no liability whatsoever relating to the choice, selection or use of the ST products and services described herein.

No license, express or implied, by estoppel or otherwise, to any intellectual property rights is granted under this document. If any part of this document refers to any third party products or services it shall not be deemed a license grant by ST for the use of such third party products or services, or any intellectual property contained therein or considered as a warranty covering the use in any manner whatsoever of such third party products or services or any intellectual property contained therein.

UNLESS OTHERWISE SET FORTH IN ST'S TERMS AND CONDITIONS OF SALE ST DISCLAIMS ANY EXPRESS OR IMPLIED WARRANTY WITH RESPECT TO THE USE AND/OR SALE OF ST PRODUCTS INCLUDING WITHOUT LIMITATION IMPLIED WARRANTIES OF MERCHANTABILITY, FITNESS FOR A PARTICULAR PURPOSE (AND THEIR EQUIVALENTS UNDER THE LAWS OF ANY JURISDICTION), OR INFRINGEMENT OF ANY PATENT, COPYRIGHT OR OTHER INTELLECTUAL PROPERTY RIGHT.

ST PRODUCTS ARE NOT AUTHORIZED FOR USE IN WEAPONS. NOR ARE ST PRODUCTS DESIGNED OR AUTHORIZED FOR USE IN: (A) SAFETY CRITICAL APPLICATIONS SUCH AS LIFE SUPPORTING, ACTIVE IMPLANTED DEVICES OR SYSTEMS WITH PRODUCT FUNCTIONAL SAFETY REQUIREMENTS; (B) AERONAUTIC APPLICATIONS; (C) AUTOMOTIVE APPLICATIONS OR ENVIRONMENTS, AND/OR (D) AEROSPACE APPLICATIONS OR ENVIRONMENTS. WHERE ST PRODUCTS ARE NOT DESIGNED FOR SUCH USE, THE PURCHASER SHALL USE PRODUCTS AT PURCHASER'S SOLE RISK, EVEN IF ST HAS BEEN INFORMED IN WRITING OF SUCH USAGE, UNLESS A PRODUCT IS EXPRESSLY DESIGNATED BY ST AS BEING INTENDED FOR "AUTOMOTIVE, AUTOMOTIVE SAFETY OR MEDICAL" INDUSTRY DOMAINS ACCORDING TO ST PRODUCT DESIGN SPECIFICATIONS. PRODUCTS FORMALLY ESCC, QML OR JAN QUALIFIED ARE DEEMED SUITABLE FOR USE IN AEROSPACE BY THE CORRESPONDING GOVERNMENTAL AGENCY.

Resale of ST products with provisions different from the statements and/or technical features set forth in this document shall immediately void any warranty granted by ST for the ST product or service described herein and shall not create or extend in any manner whatsoever, any liability of ST.

ST and the ST logo are trademarks or registered trademarks of ST in various countries.

Information in this document supersedes and replaces all information previously supplied.

The ST logo is a registered trademark of STMicroelectronics. All other names are the property of their respective owners.

© 2013 STMicroelectronics - All rights reserved

STMicroelectronics group of companies

Australia - Belgium - Brazil - Canada - China - Czech Republic - Finland - France - Germany - Hong Kong - India - Israel - Italy - Japan - Malaysia - Malta - Morocco - Philippines - Singapore - Spain - Sweden - Switzerland - United Kingdom - United States of America

www.st.com

