



SSL3250A

Photo flash dual LED driver

Rev. 03 — 30 June 2009

Product data sheet

1. General description

The SSL3250A is a photo flash LED driver designed for battery operated mobile devices such as mobile phones and PDAs. The boost converter delivers high performance and drives a single or dual, high brightness LED at up to 500 mA with over 85 % efficiency. The driver can be programmed to operate in Flash, Torch or Indicator / Video-on mode.

The small silicon size and the high internal switching frequency of 1.2 MHz minimize the SSL3250A footprint making it very suitable for mobile phones where space is limited, and only requiring four external components. Driving a high power flash LED within its safe operating limits was a concern when the SSL3250A was designed, so a time-out function can be programmed via the I²C interface, which will prevent overstressing the LED. Due to the specific requirements of a mobile phone, the flash current can be rapidly lowered during RF transmit by using optional external setting resistors.

2. Features

- High power single, or dual, LED output driving up to 500 mA flash current
- Separate indicator LED output of 2.5 mA to 20 mA
- Output voltage of up to 9.5 V
- Wide input voltage range of 2.7 V to 5.5 V
- High efficiency, over 85 % at optimum output current
- Switching frequency of 1.2 MHz
- Flash, Torch, and Indicator mode supported
- Internally timed flash operation up to 820 ms
- I²C-bus, programmable up to 400 kHz
- Strobe signal to avoid I²C latency for flash
- Discrete enable signals for stand-alone operation
- Optional resistor configurable output currents
- Fast response to accommodate external TxMasking functionality
- Soft start in Torch and Flash modes to avoid battery overloading
- Integrated protection circuits for enhanced system reliability
 - ◆ Internal time-out function
 - ◆ OverTemperature Protection (OTP)
 - ◆ UnderVoltage LockOut (UVLO)
 - ◆ OverVoltage Protection (OVP)
 - ◆ Output current protection
 - ◆ Interrupt signaling to system controller
- Low device shut-down current, less than 1 μ A
- SOT758-3, thermally enhanced 16 terminal HVQFN package



3. Applications

- White LED driver for battery powered portable devices
- Photo flash LED driver for mobile phones and digital cameras

4. Ordering information

Table 1. Ordering information

Type number	Package		Version
	Name	Description	
SSL3250AHN/C1	HVQFN16	plastic thermal enhanced very thin quad flat package; no leads; 16 terminals; body 3 × 3 × 0.85 mm	SOT758-3

4.1 Ordering options

Table 2. Ordering options

Type number	Orderable part number	Pin 1 indicator location for tape and reel
SSL3250AHN/C1	SSL3250AHN/C1,528	Pin 1 in quadrant 2. See Figure 1 .

5. Marking

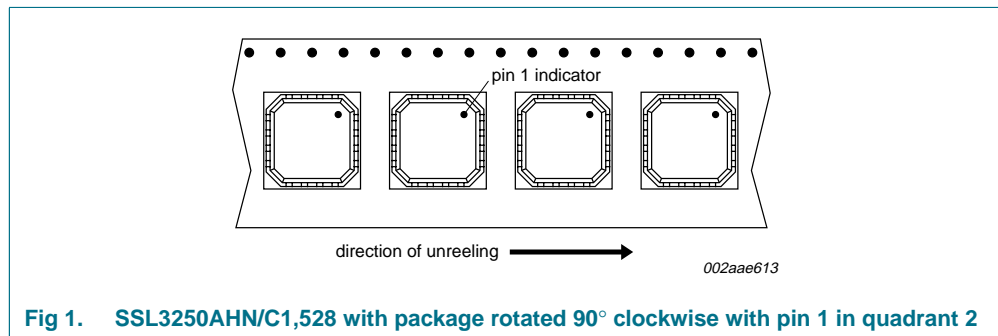

Fig 1. SSL3250AHN/C1,528 with package rotated 90° clockwise with pin 1 in quadrant 2

6. Block diagram

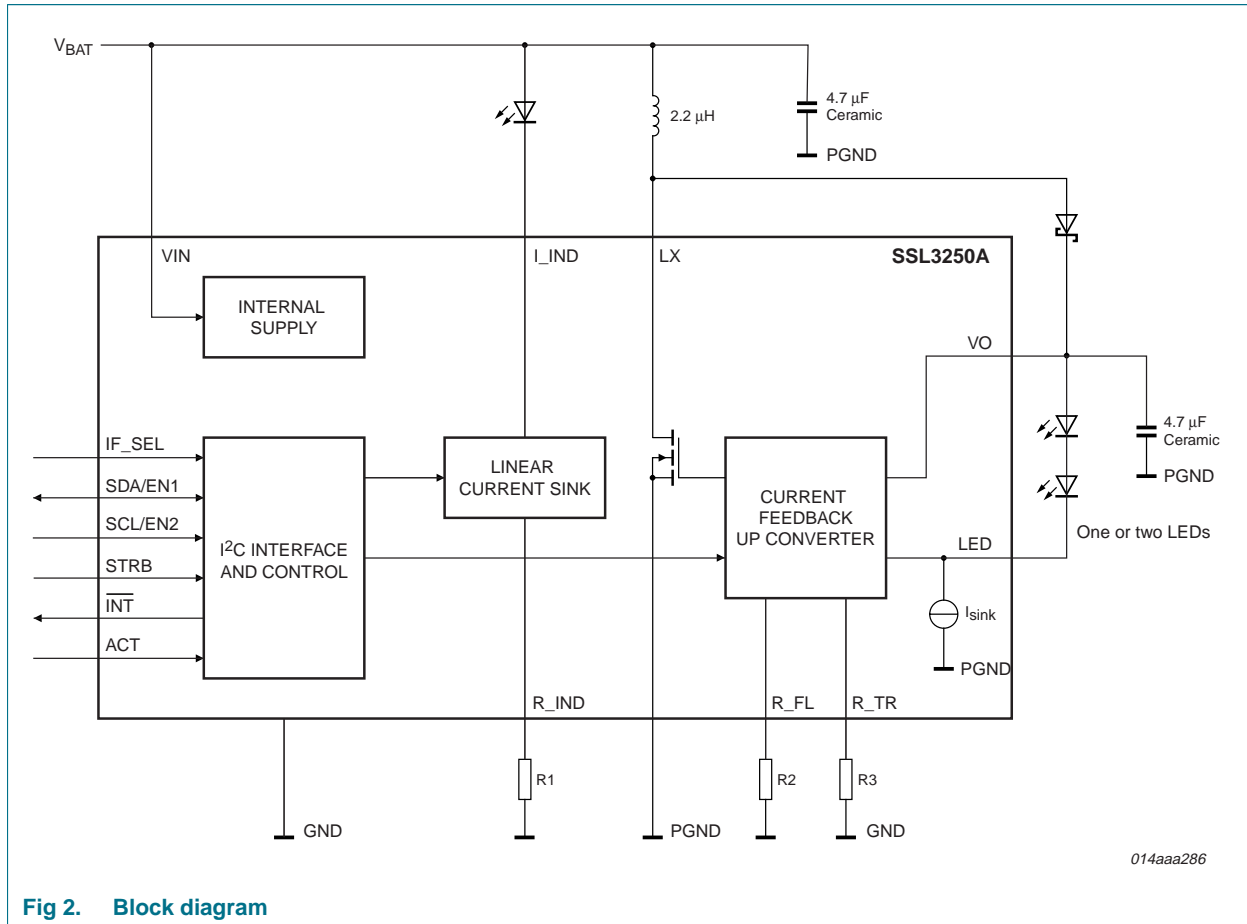
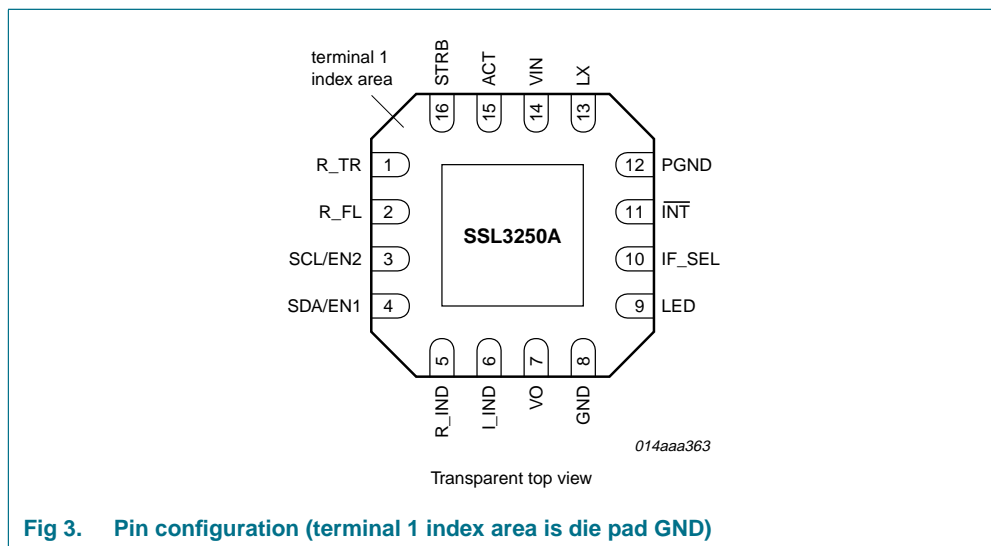

Fig 2. Block diagram

014aaa286

7. Pinning information

7.1 Pinning



7.2 Pin description

Table 3. Pin description

Symbol	Pin	Type	Description
R_TR	1	Analog IO	Setting resistor for torch current
R_FL	2	Analog IO	Setting resistor for flash current
SCL / EN2	3	I	Serial Clock Line (SCL) in I ² C mode / Enable 2 in Direct enable mode
SDA / EN1	4	I/O	Serial Data Line (SDL) in I ² C mode / Enable 1 in Direct enable mode
R_IND	5	Analog IO	Setting resistor for indicator current
I_IND	6	Analog I	Indicator LED current sink
VO	7	Analog O	Output voltage
GND	8	Ground	Ground
LED	9	Analog I	Feedback of the main LED current
IF_SEL	10	I	Interface select; choose between direct enable control or I ² C
INT	11	O	Interrupt output (open collector)
PGND	12	Ground	Power ground
LX	13	Analog I	Inductor connection
VIN	14	Input	Input voltage
ACT	15	I	Activate
STRB	16	I	Strobe signal to enable flash in I ² C mode
Die pad	-	analog	Exposed die pad; connect to GND

8. Functional description

8.1 Introduction

The SSL3250A is an asynchronous boost converter intended to drive either a single high power flash LED or two high power flash LEDs in series. The main LED current is controlled by the output voltage of the boost converter and the integrated linear current sink. The SSL3250A has two interface modes and five operational modes. The control interface is selected by the interface select pin IF_SEL. Depending on the interface mode selected, the device can either be controlled by an I²C interface or by external enable lines. Both interface modes control the five operational modes. These operational modes are:

- Shut-down mode
- Standby mode
- Indicator mode
- Torch mode
- Flash mode

The first mode is entered by putting a LOW level on the activate pin (ACT). This pin is common for both interface modes. The operational modes Torch and Flash apply to the same main LED current source, and the Indicator mode applies to a separate indicator LED current source. Only when the I²C interface mode is enabled, the operational modes Indicator, Flash and/or Torch can be used in parallel.

In normal operation, the regulated converter uses Pulse Width Modulation (PWM), so the switching frequency is constant in all modes.

In applications where the required main LED voltage is lower than the applied input voltage, the converter switches to linear mode. The excess voltage difference between the required LED voltage and the input voltage is now compensated by increasing the voltage over the current sink and therefore on the LED pin.

Apart from the main LED(s), a separate indicator LED can be driven from the SSL3250A. This indicator LED is driven by a linear current sink circuit that operates independently from the switch mode converter for the main LED(s).

8.2 Interface modes

The device is equipped I²C mode and Direct enable mode interfaces. Which interface mode is used, is defined by the level of the IF_SEL pin at the start-up of the device ($V_{ACT} \rightarrow$ LOW to HIGH). The state of the IF_SEL pin should be kept static after powering up the device. [Table 4](#) shows the interface possibilities.

Table 4. Interface modes

IF_SEL	Interface mode	Relevant controls
0	I ² C mode	SDA, SCL, STRB, ACT, R_FL, \overline{INT} .
1	Direct enable mode	EN1, EN2, ACT, \overline{INT} , R_TR, R_FL, R_IND, \overline{INT} .

8.2.1 Using the direct enable control

When the Direct enable mode is used, the device can be switched to the various operational modes using the ACT, EN1 and EN2 control signals. The definition of these control signals is given in [Table 5](#). The current in the main LED, in Torch mode and Flash mode and the LED current in the indicator LED can be independently controlled by the external current setting resistors R_IND, R_TR and R_FL. When no external current setting resistors are used, the pins should preferably be connected to VIN and the default current levels for each LED.

Table 5. Enable definition

ACT	EN2	EN1	Operational mode	LED active
0	X	X	Shut-down mode	-
1	0	0	Standby mode	-
1	0	1	Indicator mode	Indicator LED
1	1	0	Torch mode	Main LED
1	1	1	Flash mode	Main LED

The relation between the ACT and EN1, EN2 signals is given in [Figure 4](#). All modes can be entered from the Standby mode. Entering Torch mode or Indicator mode before entering Flash mode is not required.

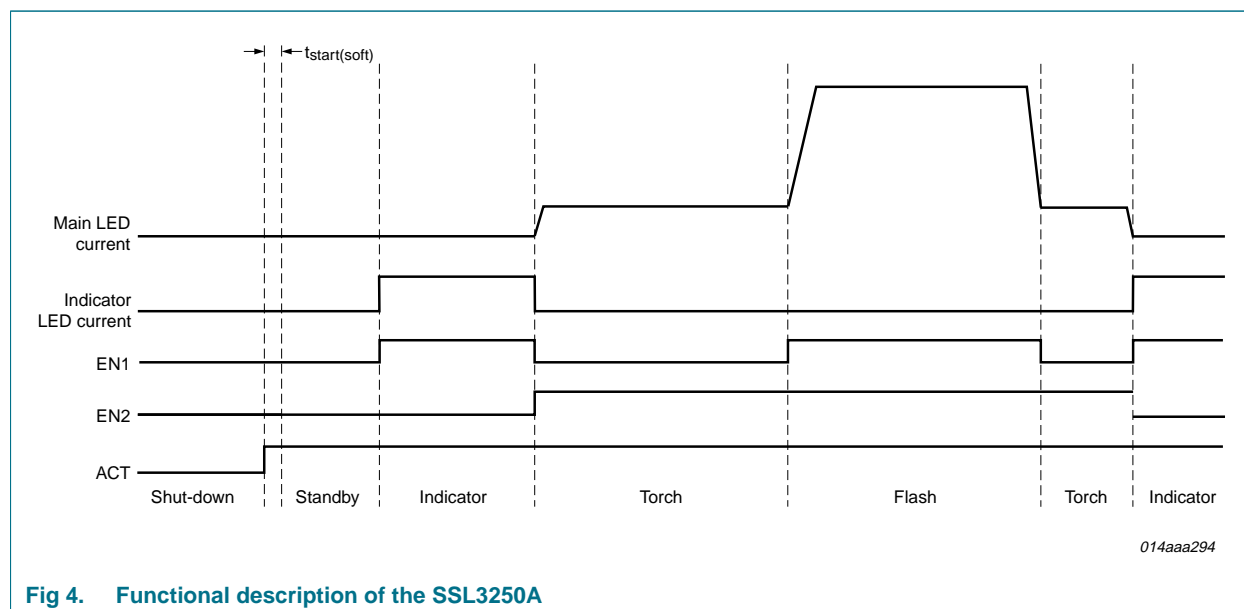

Fig 4. Functional description of the SSL3250A

8.2.2 Using the I²C control

Using the I²C mode enables additional features and settings as described in the I²C register set (see [Table 6](#)). The I²C mode has the same operational modes as described in [Section 8.2.1](#), [Figure 4](#). The Flash mode is entered in two steps:

1. Set the correct current and timing values in the current control and timing registers. This arms the device for the required flash operation.

2. Trigger the Flash mode either by the hardware STRB pin or by the FLASH_STRB bit in the Flash strobe register 02h. When the external strobe pin is not used it should be connected to GND to prevent false strobing of the main LED.

The external current setting resistor R_FL can still be used in Flash mode but is not required. When the external current setting resistor R_FL is not used, the pin should preferably be connected to VIN, this way a default resistor value of approximately 50 kΩ is assumed. The current setting resistors for the indicator LED, R_IND and for the Torch mode, R_TR have no function in I²C mode and the pins should preferably be connected to VIN.

8.3 Operational modes

8.3.1 Shut-down mode

The device is in Shut-down mode when the activate pin (ACT) is LOW. In Shut-down mode the internal circuitry of the device is turned off to guarantee a low shut-down current. The N-channel MOSFET (NMOS) is set to high-impedance. To limit the LED current to a minimum leakage, the current sink circuitry for both the main LED and the indicator LED are switched to high-impedance. After making the pin ACT HIGH, the device will start up and is ready to receive commands through the selected interface.

8.3.2 Standby mode

In Standby mode the internal circuitry of the device remains on, but the converter is not switching. The NMOS is set to high-impedance. To limit the LED current to a minimum leakage, the current sink circuitry for both the main LED and the indicator LED are switched to high-impedance. In this mode the device is able to respond to I²C communication.

8.3.3 Torch mode

The Torch mode allows the main LED to be switched on, without timing limitations, at a lower LED current setting. The Torch mode current in the main LED can be set between 50 mA and 200 mA in both the I²C and Direct enable control mode.

In I²C mode, the LED current is defined by entering a value between a minimum of 1 and a maximum of 11 in the current control register. In I²C mode the external R_TR resistor is ignored. If an external R_FL resistor is connected, this resistor will also scale down the set torch current. See [Section 8.3.6](#). The current in the main LED using I²C mode is defined using [Equation 1](#). When not using the resistor R_FL, assume a value of 50 kΩ in the equation. Entering Torch mode is done by writing the required current setting in the current control register. The LED will light to the set torch current. Switching off the Torch mode can be done by writing 0h into the current control register, or by entering Flash mode, see [Section 8.3.4](#).

$$I_{LED} = \left(\frac{50 \text{ k}\Omega}{R_{R_FL}} \right) + 35 \text{ mA} + 15 \text{ mA} \times \text{Register} \quad (1)$$

When using the Direct enable mode, the torch current is defined by an external resistor connected to the R_TR pin. The LED current is defined using [Equation 2](#). When not using the current set resistor, the torch current will be set to a default level of 125 mA. The

default current is equal to connecting an external current set resistor of 50 kΩ. Entering Torch mode in Direct enable mode can be done using the EN1 and EN2 pins. The LED will stay on in Torch mode for as long as the enable pins are set to Torch mode.

$$I_{LED} = \frac{50 \text{ k}\Omega}{R_{R_TR}} \times 125 \text{ mA} \tag{2}$$

When not using an external resistor, the R_TR pin can be left unconnected, but it is preferably connected to VIN. Never connect the R_TR pin to GND since it will cause unnecessary reference currents to flow to GND.

[Figure 5](#) illustrates the Torch mode current setting equation for I²C, while [Figure 6](#) illustrates the Torch mode current setting equation for the Direct enable mode.

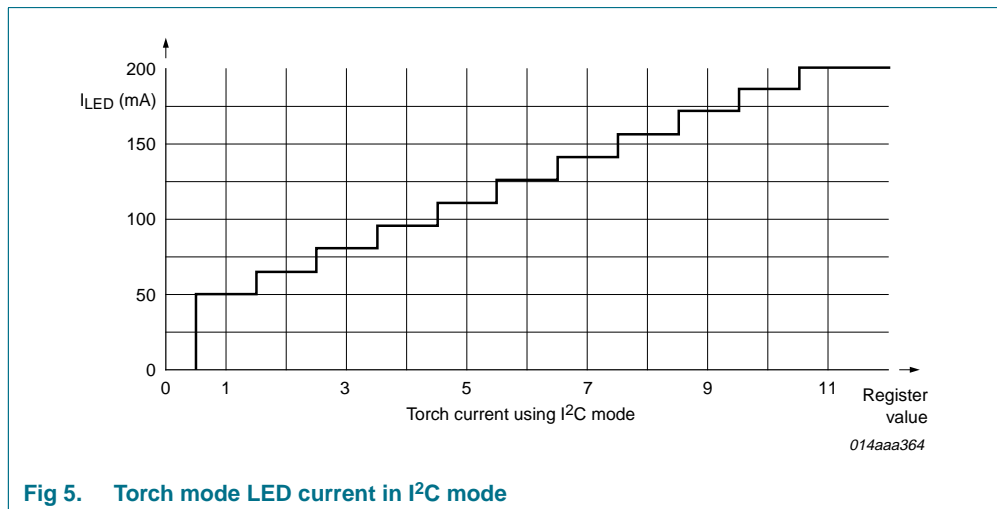

Fig 5. Torch mode LED current in I²C mode

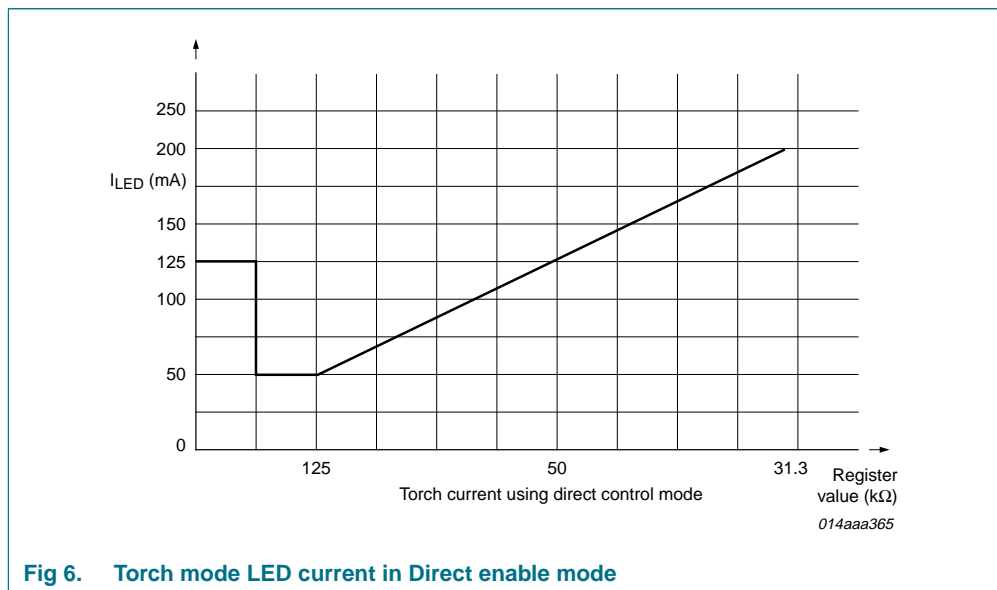

Fig 6. Torch mode LED current in Direct enable mode

8.3.4 Flash mode

The Flash mode allows the main LED to be used at high LED current setting. The Flash mode current can be set up to 500 mA in both the I²C and Direct enable mode.

In I²C mode, the current is defined by entering a value between a minimum of 12 and a maximum of 31 in the current control register. The external resistor R_{FL} can be used to scale down the set current. This can be used in the application to enable TxMasking as described in [Section 8.3.6](#). The current in the main LED is defined using [Equation 3](#). When not using the R_{FL} resistor, assume a resistor value of 50 kΩ in the equation. Entering Flash mode can be done either by using the STRB pin or the FLASH_STRB bit in Flash Strobe register 02h. The duration of the flash can be determined by a timer, STRB triggering or by a time-out. The flash timing is given by [Equation 3](#) and in [Section 8.4.2](#).

$$I_{LED} = \frac{50 \text{ k}\Omega}{R_{R_FL}} \times (35 \text{ mA} + 15 \text{ mA} \times \text{Register}) \tag{3}$$

When using the Direct enable mode, the flash current can be defined by an external resistor connected to the R_{FL} pin. The current in the main LED is defined using [Equation 4](#). When not using the current set resistor, the flash current will be set to a default level of 500 mA. The default current is equal to connecting an external current set resistor of 50 kΩ. Entering Flash mode in Direct enable mode can be done using the EN1 and EN2 pins. The LED will stay on in Flash mode for as long as the enable pins are set to Flash mode, but is limited to 820 ms maximum by the time-out timer.

$$I_{LED} = \frac{50 \text{ k}\Omega}{R_{R_FL}} \times 500 \text{ mA} \tag{4}$$

When no external current set resistor is used, the R_{FL} pin can be left unconnected but is preferably connected to VIN. Never connect the R_{FL} pin to GND as this will cause unnecessary reference currents to flow to GND.

[Figure 7](#) illustrates the Flash mode current setting equation for I²C, while [Figure 8](#) illustrates the Flash mode current setting equation for the Direct enable mode.

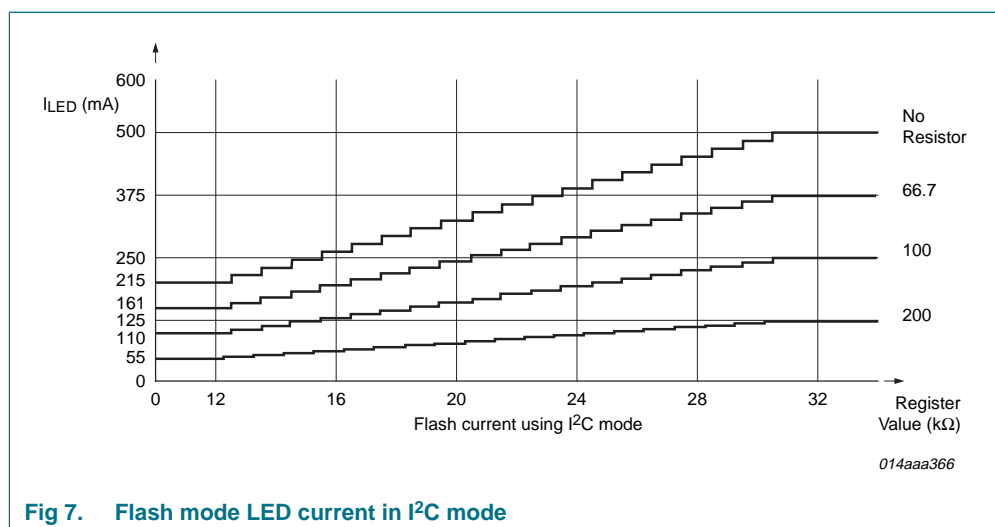

Fig 7. Flash mode LED current in I²C mode

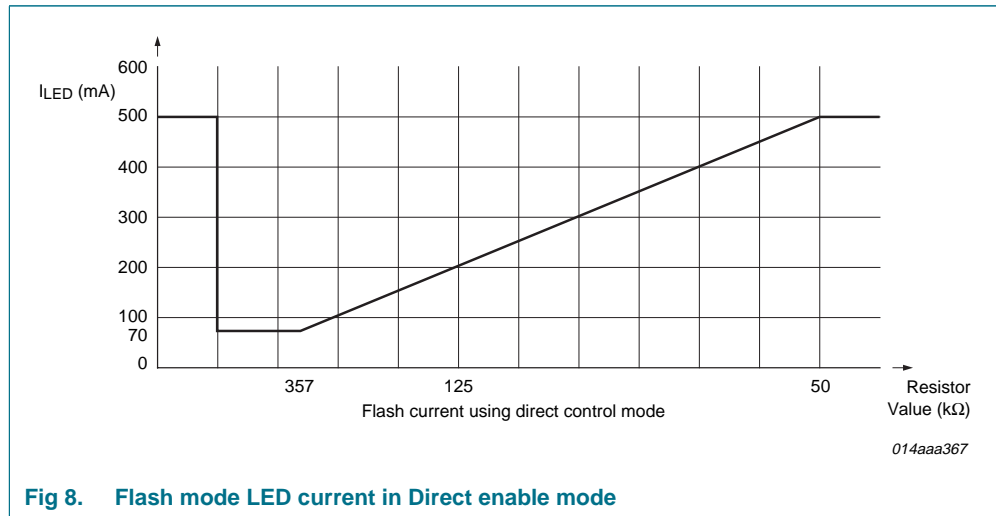

Fig 8. Flash mode LED current in Direct enable mode

8.3.5 Timed Flash mode

The timed operation of the Flash mode can only be used in the I²C interface mode. When the flash is used in Timed mode (bit 4, TO_DEF = 1 in Timer control register 01h), the internal timer will switch off the main LED after the preprogrammed maximum time in the timer control register has expired.

The timer starts when the Flash mode is activated either by the software strobe (FLASH_STRB bit in register 02h) or by a LOW to HIGH transition of the hardware strobe (STRB pin) signal.

In timed mode strobing of the flash is edge sensitive, therefore the flash time is independent of the level of the software or hardware strobe signal. The flash time is set according to [Equation 5](#):

$$t_{flash} = 820 \text{ ms} - \text{Register} \times 54.6 \text{ ms} \quad (5)$$

Once the Flash time has expired no interrupt will be generated nor will it be flagged in the status register. A new flash period can be started immediately after the previous timed flash period has expired.

8.3.6 Flash mode during RF transmit

Although the driver is not equipped with a separate TXMASK pin, the device can operate like that to lower the current in the main LED in Flash mode during an RF transmission in a mobile phone application. An external switch can be connected to the resistor controlling the nominal current value for the Flash mode. By lowering the current in the main LED, the inductor current and therefore the current drawn from the battery will be lowered. Reducing the inductor current has to be fast because the inductor current is reduced within 50 μ s after changing the nominal current level to a lower setting. At the end of the transmission period, the main LED current can be increased again to the nominal current level. A soft start circuit will increase the inductor current with a limited slope as defined by the soft start settings. See [Section 8.5](#).

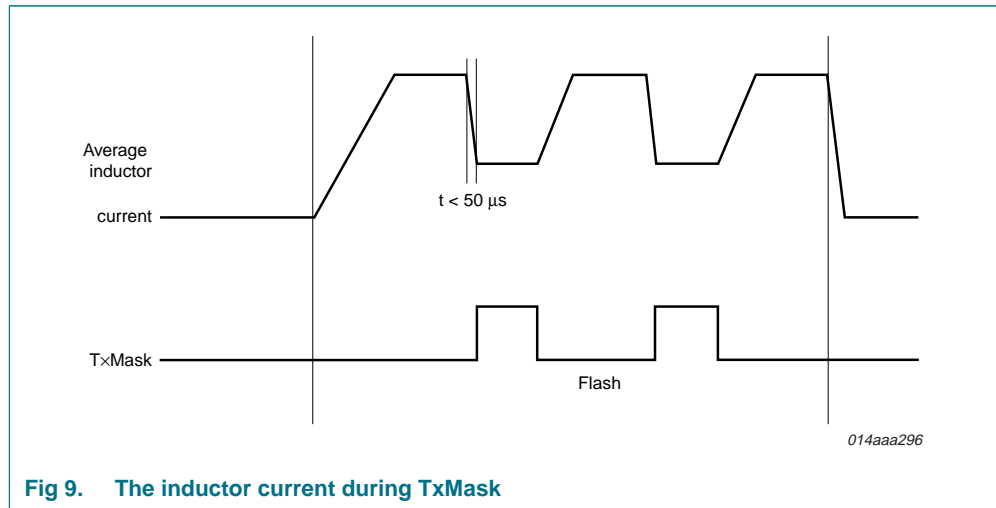

Fig 9. The inductor current during TxMask

8.3.7 Indicator LED

The indicator LED is connected between the V_{BAT} and the dedicated indicator LED current input pin. Internally a linear current sink controls the indicator LED current to reach the required current level.

In I²C mode, the indicator LED current can be set between 2.5 mA and 17.5 mA. The internal 3-bit register sets the actual indicator LED according to the formula in [Equation 6](#). The external resistor R_{IND} is ignored.

$$I_{I_IND} = Register \times 2.5 \text{ mA} \quad (6)$$

When using the Direct enable mode, the indicator current can be determined by an external resistor R_{IND} . The indicator current is defined using [Equation 7](#). It can be set between 2.5 mA and 20 mA. When not using the resistor, the indicator current will be set to a default level of 10 mA. This current is similar to connecting an external resistor of 50 k Ω . Entering Flash mode in Direct enable mode can be done using the EN1 and EN2 pins. The LED will stay on in Flash mode for as long as the enable pins are set.

$$I_{I_IND} = \frac{50 \text{ k}\Omega}{R_{R_IND}} \times 10 \text{ mA} \quad (7)$$

If there is no resistor connected to the R_{IND} pin, it can either be left unconnected or connected to V_{IN} . Never connect the R_{IND} pin to GND since it will cause unnecessary reference currents to flow to GND.

[Figure 10](#) illustrates the Indicator mode current setting equation for I²C, while [Figure 11](#) illustrates the Indicator mode current setting equation for the Direct enable mode.

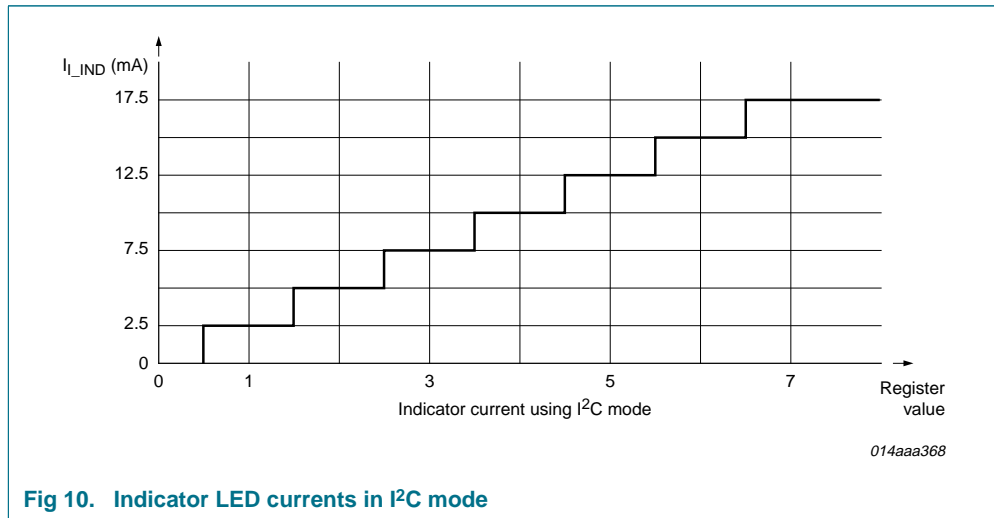

Fig 10. Indicator LED currents in I²C mode

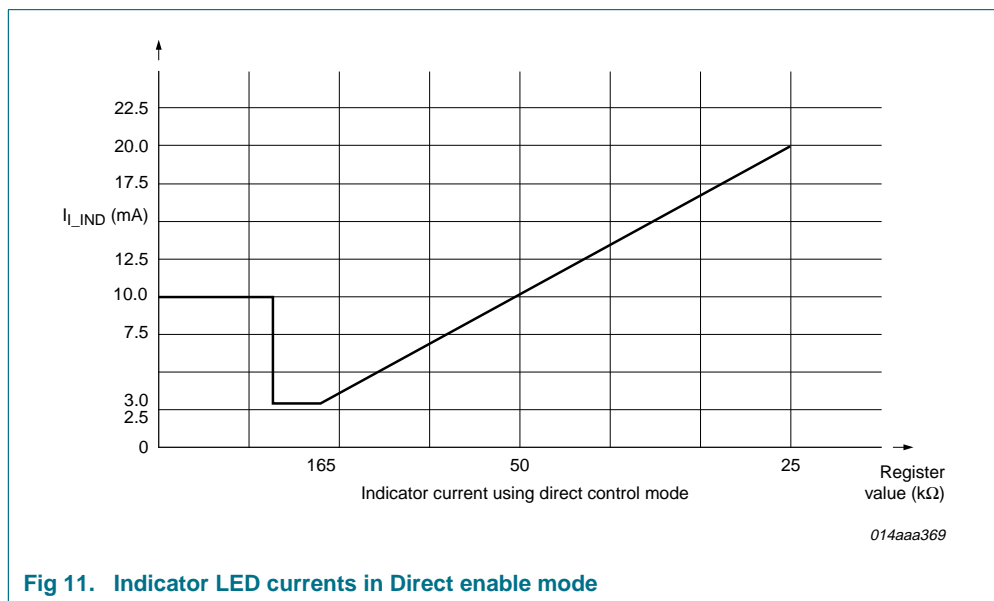

Fig 11. Indicator LED currents in Direct enable mode

8.4 Protection circuits

There are several protection circuits integrated in the device. These protection circuits protect the device and the application against defects. The SSL3250A has four protection circuits that will inhibit switching of the converter, programming the status register 03h and pulling LOW the interrupt line. The interrupt line, which can be connected to external logic, signaling an error condition. The external logic can read the status register to determine which fault caused the interrupt and decide on the proper action to take. When not using the I²C mode, the status register cannot be read out but the interrupt line still is functional to signal a fault condition.

The four protection circuits and their bits in the status register are as follows:

- Overvoltage protection
- Time-out protection
- Overtemperature protection
- Output short protection

When a protection is triggered, switching of the IC is inhibited without a soft ramp-down of the current in the main LED and also the indicator LED will be switched off.

To recover from this fault condition in I²C mode, write 00h to the current control register (00h) to clear the status register release the $\overline{\text{INT}}$ line. After clearing the status register, the current control register can be reloaded and the flash can be retriggered. Reloading the other registers is not necessary as they will not lose their value when an interrupt is generated. In Direct enable mode the status register is cleared and the $\overline{\text{INT}}$ line is released, by making both the EN1 and EN2 pins IO.

8.4.1 Overvoltage protection

If the output voltage (V_O) exceeds its limit (V_{ovp} , see [Table 9](#)), switching of the converter is inhibited. The output voltage will exceed V_{ovp} limit when no LEDs are connected between pins VO and LED. In some cases an overvoltage protection may occur when the LED pin is shorted to GND during the period a Flash is generated.

The converter is trying to compensate for the loss of feedback current by increasing V_O .

When an overvoltage is encountered, the OVPtrig flag (bit 0) is set in the status register.

8.4.2 Untimed Flash mode

To avoid overloading of the main LED during a flash in Direct enable mode or I²C control mode in untimed Flash mode (bit 4, TO_DEF = 0 in Timer control register 01h). A time-out timer limits the maximum ON time of the flash. In both control modes the flash time-out time is set to a fixed level of 820 ms.

When the flash strobe signal is set to LOW in I²C control mode, bit 0 in register 02h is set to 0. When the EN1 signal is set to LOW before the time-out timer has expired in Direct enable mode, the time-out timer is reset.

When a time-out situation is encountered, the TOtrig flag (bit 1) is set in the status register. See also [Section 8.3.5](#).

8.4.3 Overtemperature protection

If the chip temperature exceeds its limit (T_{otp} , see [Table 9](#)), switching of the converter is inhibited until the temperature drops below its limit minus a small hysteresis.

When an overtemperature situation is encountered, the OTtrig flag (bit 2) is set in the status register.

8.4.4 Short circuit protection

To prevent device and battery overloading, the converter is short circuit protected. In case the LED pin is shorted to GND due to an application failure, the switching of the converter is inhibited. Typical response times between detection of the LED pin shorted to GND and inhibit switching of the converter is less than 1 ms. The short circuit protection is functional at any time during Torch mode and also during the soft start phase of the flash period.

The short circuit protection may also be triggered when either the inductor or the diode is not connected. Also, a shorted diode may trigger the output short protection, if two LEDs are connected in series between VO and LED pins. Therefore little or no current will flow through the LEDs or into the LED pin and V_{LED} will stay almost at GND level.

When an overvoltage is encountered, the OS_PROT flag (bit 3) is set in the status register.

Remark: If V_{BAT} is HIGH and only one White LED is connected between VO and LED pins, the Schottky diode may be irreversibly damaged when the LED pin is shorted. This is inherent to the asynchronous boost converter topology.

8.4.5 Interrupt line

The interrupt pin \overline{INT} is an active LOW open-drain output allowing for multiple devices to be connected as a wired OR, using the same interrupt line to the external control logic. On the interrupt line, only one pull-up resistor is needed in the complete system.

8.4.6 Undervoltage lockout

As a result of a low battery voltage, the input voltage can drop too low to guarantee normal operation. When the input voltage has dropped below the undervoltage lockout level, the device switches to an undervoltage lockout state stopping all operations of the device. Start-up is only possible by crossing the start-up level again. Recovering from this error results in the loss of all register settings. This protection does not generate an interrupt on the \overline{INT} line nor is it flagged in the status register 03h.

8.5 Soft start

To avoid battery overloading when entering the Torch mode or the Flash mode, the device is equipped with a soft start circuit. This circuit limits the rate of rise of the LED current to 4.5 mA/ μ s until the required LED current has been reached. When the device ends Flash mode or Torch mode, the LED current decreases with a controlled slope of 9 mA/ μ s. Whenever a protection is activated, the LED current decreases without the controlled slope and drops immediately to zero.

8.6 Peak current limit

To avoid saturation of the inductor, the device is equipped with a peak current limit function. This circuit limits the peak inductor currents to 2.2 A. No protection is activated.

8.7 I²C-bus protocol

The I²C interface is a 2-wire serial interface developed by NXP Semiconductors to communicate between different ICs or modules. The two wires are an SDA wire and an SCL wire. Both lines must be connected to a positive supply via a pull-up resistor when

connected to the output stages of a device. Data transfer may only be initiated when the bus is not busy. The SSL3250A I²C bus characteristic is according to the 400 kbit/s Fast-mode I²C from the I²C-bus specification.

Remark: For more details on the I²C standard, refer to the document *UM10204, "I²C-bus specification and user manual", version 0.3, June 2007*, which can be downloaded from the NXP web site (www.nxp.com).

The following describes the protocols used by the SSL3250A for the read and write sequences. The read sequence may use a repeated start condition during the sequence to avoid that the bus is released during the communication. The sequences can be used to read or write only one data byte or to read or write a sequence of data bytes.

[Figure 12](#) shows a write sequence for a single byte write. [Figure 13](#) show the read sequence for a single byte.

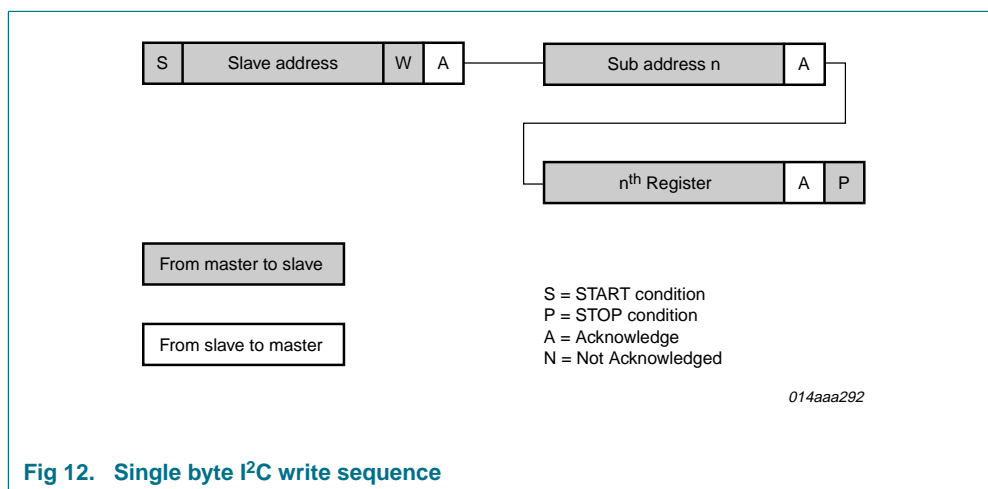

Fig 12. Single byte I²C write sequence

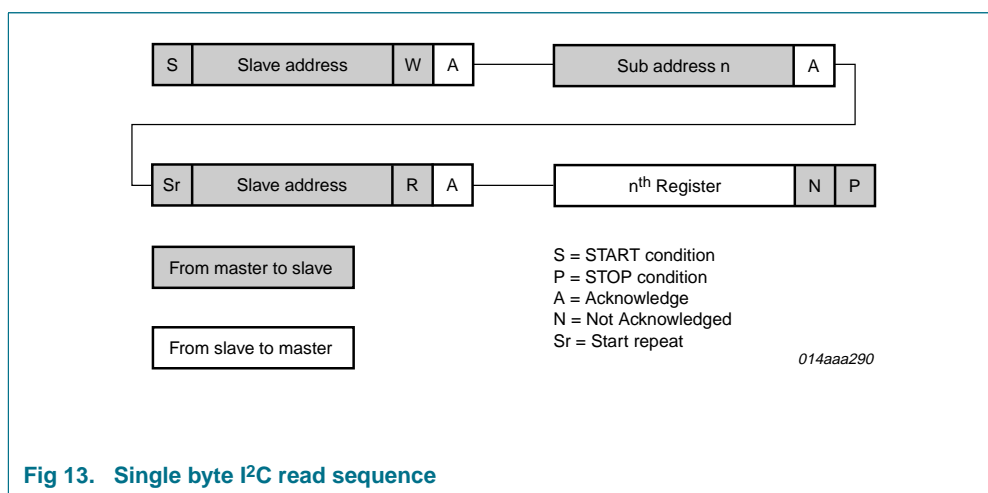

Fig 13. Single byte I²C read sequence

8.7.1 Addressing

Each SSL3250A in an I²C-bus system is activated by sending a valid address to the device. The address always has to be sent as the first byte after the start condition in the I²C-bus protocol [Figure 14](#).

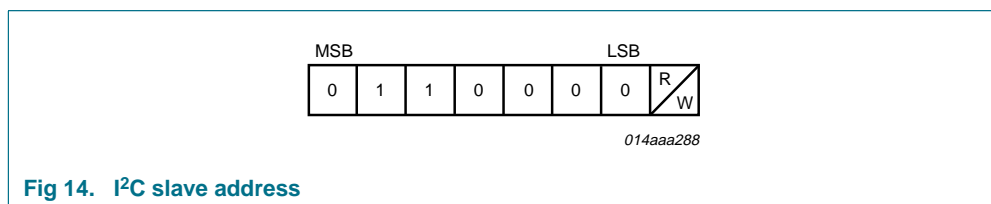

Fig 14. I²C slave address

There is one address byte required since 7-bit addresses are used. The last bit of the address byte is the read/write-bit and should always be set according to the required operation. This 7-bit I²C address is 0110000b (30h). The 7-bit address plus the R/W bit create an 8-bit write address of 60h and a read address of 61h.

The second byte sent to the SSL3250A is the subaddress of a specific register.

8.7.2 Data

After the subduers have been sent the data byte(s) are sent. The definition of the data byte(s) is given in [Figure 12](#). After each data byte an acknowledge is given and the subduers is automatically incremented to the next subduers.

A description of the data that can be programmed in the registers is given in the register map in [Section 8.7.3](#).

8.7.3 Register map

Table 6. Description of registers

Legend: * default register value

Address	Register	Bit	Symbol	Access	Value	Description
00h	Current control	7 to 3	MAIN_LEVEL	R/W	0000*	Off (default)
					00001	Torch mode, see Section 8.3.3
					00010	Torch mode, see Section 8.3.3
				
					01010	Torch mode, see Section 8.3.3
					01011	Torch mode, see Section 8.3.3
					01100	Flash mode (armed), see Section 8.3.4
		01101	Flash mode (armed), see Section 8.3.4			
				
		11110	Flash mode (armed), see Section 8.3.4			
		11111	Flash mode (armed), see Section 8.3.4			
		2 to 0	IND_LEVEL	R/W	000*	Off (default)
					001	Indicator on, 2.5 mA
					011	Indicator on, 5 mA
.....					
111	Indicator on, 17.5 mA					

Table 6. Description of registers ...continued

Legend: * default register value

Address	Register	Bit	Symbol	Access	Value	Description
01h	Timer control	7 to 5	Reserved	-	-	-
		4	TO_DEF	R/W	0*	Select time-out limit (default)
					1	Select timed operation
		3 to 0	TO	R/W	0000*	820 ms (default)
					0001	765 ms
				
					1110	56 ms
			1111	1 ms		
02h	Flash strobe	7 to 1	Reserved	-	-	-
		0	FLASH_STRB	R/W	0*	-
					1	Enable flash
03h	Status	7 to 4	Reserved	-	-	-
		3	OStrig	R	0*	LED not shorted to GND
					1	LED shorted to GND
		2	OTPtrig	R	0*	Temperature < maximum temperature
					1	Temperature > maximum temperature; Protection triggered
		1	TOtrig	R	0*	Flash time < Time-out
					1	Flash time > Time-out, Protection triggered
	0	OVPtrig	R	0*	$V_O < V_{ovp}$	
			1	$V_O > V_{ovp}$, protection triggered		

9. Application design-in information

9.1 Input capacitor

For good input voltage decoupling a low ESR ceramic capacitor is highly recommended. A 4.7 μF (X5R/X7R) 6.3 V is the minimum recommended value. Since the input capacitor is supplying the input ripple current, a larger capacitor will improve transient behavior of the regulator and EMI behavior of the power supply. Taking the capacitor DC bias and the temperature derating specifications into account, a 10 μF (X5R/X7R) is preferred. Although it is increasing the component count, a smaller capacitor of 100 nF (X5R/X7R) placed in parallel to the input capacitor will also improve EMI behavior.

When the circuit is used in other than battery powered applications and the input capacitor is located relatively far from the DC buffer capacitors, it is recommended to add a 150 μF tantalum or a 470 μF electrolytic capacitor in parallel near the input capacitor.

9.2 Output capacitor

The output capacitor supplies the current to the main LED, while the inductor is being charged, and it also ensures loop stability. The minimum capacitance for stable loop operation would be 2.2 μF , but taking the capacitor DC bias and the temperature derating specifications into account, a low ESR ceramic capacitor of 4.7 μF (X5R/X7R) is highly recommended. A higher value of capacitance will improve output current ripple, while

maintaining loop stability. The SSL3250A overvoltage limit on V_O is 10.3 V (typ). The rated voltage of the output capacitor should be at least 16 V. For solution size reasons lower value ceramic capacitors could be placed in parallel.

9.3 Inductor

The device has been designed to operate well with inductance values between 1.5 μH and 3.3 μH , in order to optimize for solution size. In a typical high current dual flash LED application a 2.2 μH inductance is recommended. The inductors saturation current should be greater than or equal to the inductor peak current limiter current, which is typical 2.2 A. During normal operation, it is recommended to keep the inductor peak current below this value.

The copper losses and magnetic hysteresis losses in the inductor also contribute to the total system losses.

9.4 Rectifier diode

Selecting a Schottky diode with low forward voltage drop improves efficiency. Although the average current through the diode is equal to the load current and independent on duty cycle for a boost converter topology, it is recommended to select a diode with an average current rating that is significantly higher. The peak current rating of the diode should be greater than the peak current through the inductor.

9.5 PCB layout

It is essential to have a good circuit layout to maximize efficiency and minimize EMI disturbance. Because the circuit topology uses an inductor, it is often appointed as a main source for EMI disturbance. But any loop of wire carrying a current is essentially an electromagnet with a field strength that is proportional to the current. Therefore careful circuit layout is important, keeping loop areas small and minimizing magnetic flux. Due to the way an asynchronous boost converter operates, there are two power states. One state is when the internal NMOS switch is on and one when the NMOS switch is off. During each state there will be a current loop made by the power components that are conducting. Arrange the input capacitor, rectifier diode and output capacitor in such a way around the SSL3250A that during each of the two states the current loop is conducting in the same direction. This prevents phase reversal of the magnetic field and reduces radiated EMI. The current loop area should be kept small by placing the power components as close as possible to the SSL3250A. Use ground planes to keep loop areas to a minimum.

Priority should be given to positioning the output capacitor and the rectifier diode as close as possible to the LX and PGND nodes of the SSL3250A. Since large currents will flow from the input capacitor to the inductor and not into the VIN pin of the SSL3250A, it is wise to locate the input capacitor near the inductor. The VIN pin should be star connected to the positive pad of the input capacitor. It is recommended to place an extra 100 nF capacitor from VIN to GND directly next to the SSL3250A.

PGND and GND of the SSL3250A should be directly connected to each other preferably by using the die pad area under the SSL3250A. Place the ground connection of the output capacitor as close as possible to the PGND pin of the SSL3250A.

If the SSL3250A is used in Direct enable mode and external resistors are used, place the external resistors near the SSL3250A, to minimize disturbance on the output current. Connect the other end of the resistors to a 'clean' ground, that is ground that is not carrying any large currents. It is preferable to connect all resistor grounds to one trace and connect that trace to the GND pin of the SSL3250A.

The preferred minimum trace width for the high current width is 15 mil per Ampere.

10. Limiting values

Table 7. Limiting values

In accordance with the Absolute Maximum Rating System (IEC 60134). Voltages referenced to GND.

Symbol	Parameter	Conditions	Min	Max	Unit
V_I	input voltage		-0.5	+5.5	V
V_{ACT}	voltage on pin ACT		-0.5	V_I	V
V_{SDA}	voltage on pin SDA		-0.5	V_I	V
V_{EN1}	voltage on pin EN1		-0.5	V_I	V
V_{SCL}	voltage on pin SCL		-0.5	V_I	V
V_{EN2}	voltage on pin EN2		-0.5	V_I	V
V_{STRB}	voltage on pin STRB		-0.5	V_I	V
V_{IF_SEL}	voltage on pin IF_SEL		-0.5	V_I	V
$V_{\overline{INT}}$	voltage on pin \overline{INT}		-0.5	V_I	V
V_{L_IND}	voltage on pin L_IND		-0.5	V_I	V
V_{LED}	voltage on pin LED		-0.5	V_O ^[1]	V
V_O	output voltage		-0.5	+20 ^[1]	V
V_{LX}	voltage on pin LX		-0.5	+20 ^[1]	V
V_{R_IND}	voltage on pin R_IND		-0.5	V_I	V
V_{R_TR}	voltage on pin R_TR		-0.5	V_I	V
V_{R_FL}	voltage on pin R_FL		-0.5	V_I	V
V_{PGND}	voltage on pin PGND		-0.5	+0.5	V
P_{tot}	total power dissipation	$T_{amb} = 85\text{ }^\circ\text{C}$	-	1.0	W
T_j	junction temperature		-40	+150	$^\circ\text{C}$
T_{amb}	ambient temperature		-40	+85	$^\circ\text{C}$
T_{stg}	storage temperature		-40	+150	$^\circ\text{C}$
V_{ESD}	electrostatic discharge voltage	class 2			
		human body model; all pins	^[2] -	2000	V
		machine model; all pins	^[2] -	150	V
		charged-device model; all pins	^[3] -	500	V

[1] Tolerant to the specified maximum voltage while operating. Do not apply voltages externally; this may cause permanent damage to the device.

[2] Equivalent to discharging a 200 pF capacitor through a 0.75 μH coil and a 10 Ω resistor.

[3] Equivalent to discharging the device (charged with > 10 M Ω resistor) through a 1 Ω measurement resistor.

11. Thermal characteristics

Table 8. Thermal characteristics

Symbol	Parameter	Conditions	Typ	Unit
$R_{th(j-a)}$	thermal resistance from junction to ambient	Based on modeling on a four layer board in free air and five thermal vias under the IC. ^[1]	63	K/W

[1] The junction to ambient thermal resistance is dependent on the board layout, PCB material application, and environmental conditions.

12. Characteristics

Table 9. Characteristics

$V_I = 3.0\text{ V to }5.5\text{ V}$; $T_{amb} = -40\text{ }^\circ\text{C to }+85\text{ }^\circ\text{C}$, unless otherwise specified.

Symbol	Parameter	Conditions	Min	Typ ^[1]	Max	Unit
General voltage levels						
V_I	input voltage	on pin VIN	3.0	-	5.5	V
$V_{I(extnd)(VIN)}$	extended input voltage on pin VIN		^[2] 2.75	-	5.5	V
$V_{I(UVLO)}$	undervoltage lockout input voltage	V_I falling	2.55	2.65	2.8	V
$V_{hys(UVLO)}$	undervoltage lockout hysteresis voltage	V_I rising	50	100	150	mV
General current levels						
I_{sd}	shutdown current	Shut-down mode; ACT = 0	-	-	1	μA
$I_{leak(LX)}$	leakage current on pin LX	ACT = 0	-	-	0.5	μA
$I_{lmtr(IM)(LX)}$	peak current limiter current on pin LX	Inductor peak current limiter	-	2.2	2.4	A
Output voltages on external resistor pins						
V_{R_IND}	voltage on pin R_IND	Independent of load	^[3] 1.17	1.22	1.27	V
V_{R_TR}	voltage on pin R_TR	Independent of load	^[3] 1.17	1.22	1.27	V
V_{R_FL}	voltage on pin R_FL	Independent of load	^[3] 1.17	1.22	1.27	V
Allowed input voltages on external resistor pins						
V_{R_IND}	voltage on pin R_IND		^[3] 1.4	-	V_I	V
V_{R_TR}	voltage on pin R_TR		^[3] 1.4	-	V_I	V
V_{R_FL}	voltage on pin R_FL		^[3] 1.4	-	V_I	V
External resistors						
$R_{ext(R_IND)}$	external resistance on pin R_IND	IF_SEL = 1; Resistors used	^{[3][4]} 25 ^[5]	-	165	k Ω
$R_{ext(R_TR)}$	external resistance on pin R_TR	IF_SEL = 1; Resistors used	^{[3][4]} 25 ^[5]	-	200	k Ω
$R_{ext(R_FL)}$	external resistance on pin R_FL	IF_SEL = 1 or 0; Resistors used	^{[3][4]} 50 ^[5]	-	357	k Ω

Table 9. Characteristics ...continued $V_I = 3.0\text{ V to }5.5\text{ V}$; $T_{amb} = -40\text{ }^\circ\text{C to }+85\text{ }^\circ\text{C}$, unless otherwise specified.

Symbol	Parameter	Conditions	Min	Typ ^[1]	Max	Unit
High power LED parameters						
V_O	output voltage	on pin VO	[6] -	-	9.5	V
I_{LED}	LED current	IF_SEL = 0; current control register = 08h; STRB = 0	40	50	60	mA
		IF_SEL = 0; current control register = 30h; STRB = 0	106	125	144	mA
		IF_SEL = 0; current control register = C0h; STRB = 1	356	395	435	mA
		IF_SEL = 0; current control register = F8h; STRB = 1	450	500	550	mA
		default flash current; IF_SEL = 1; EN1 = 1; EN2 = 1; R_FL = High	[3] 450	500	550	mA
		default torch current; IF_SEL = 1; EN1 = 0; EN2 = 1; R_TR = High	[3] 106	125	144	mA
$I_{leak(LED)}$	leakage current on pin LED	ACT = 0; Shut-down mode	-	-	0.5	μA
V_{LED}	voltage on pin LED	boost mode; $I_{LED} = 0.5\text{ A}$	[7] -	300	-	mV
		follower mode	[7] 350	-	-	mV
V_{ovp}	overvoltage protection voltage		9.8	10.5	11.0	V
Indicator LED parameters						
I_{I_IND}	current on pin I_IND	IF_SEL = 0 (I ² C)	2.5	-	17.5	mA
		IF_SEL = 1 (direct enable)	2.5	-	20	mA
		default indicator current; IF_SEL = 1; EN1 = 1; EN2 = 0; R_IND = High	-	10	-	mA
ΔI_{I_IND}	current variation on pin I_IND		-	-	15	%
$I_{leak(I_IND)}$	leakage current on pin I_IND	ACT = 0; Shut-down mode	-	-	1	μA
Power MOSFET						
R_{DSon}	drain-source on-state resistance	NFET	-	200	425	mW
Timing						
f_{sw}	switching frequency		1.08	1.2	1.32	MHz
δ_{max}	maximum duty cycle		-	-	82	%
$t_{start(soft)}$	soft start time	ACT = 0 to ACT = 1 response time	-	160	400	s
$t_{to(acc)}$	accuracy of time-out time	the absolute value can be set with I ² C	10	-	10	%

Table 9. Characteristics ...continued $V_I = 3.0\text{ V to }5.5\text{ V}$; $T_{amb} = -40\text{ }^\circ\text{C to }+85\text{ }^\circ\text{C}$, unless otherwise specified.

Symbol	Parameter	Conditions	Min	Typ ^[1]	Max	Unit
I²C interface						
V _{IL}	LOW-level input voltage		-	-	0.5	V
V _{IH}	HIGH-level input voltage		1.2	-	V _{IN}	V
V _{OL}	LOW-level output voltage	I _{sink} = 3 mA	0	-	0.4	V
f _{SCL}	SCL clock frequency		0	-	400	kHz
Digital levels: EN1, EN2, STRB, ACT						
V _{IL}	LOW-level input voltage	digital	0	-	0.5	V
V _{IH}	HIGH-level input voltage	digital	1.2	-	-	V
Digital levels: IF_SEL pin						
V _{IL}	LOW-level input voltage	IF_SEL pin	0	-	0.5V _I	V
V _{IH}	HIGH-level input voltage	IF_SEL pin	0.5V _I	-	V _I	V
Digital levels: INT						
V _{OL}	LOW-level output voltage	I _{sink} = 3 mA	0	-	0.4	V
I _{IH}	HIGH-level input current		0	-	0.5	μA
Temperature						
T _{amb}	ambient temperature		-40	+25	+85	°C
T _{otp}	overtemperature protection trip	temperature rising	-	150	-	°C
T _{otp(hys)}	overtemperature protection trip hysteresis	temperature falling	-	20	-	°C

[1] All typical values are measured at T_{amb} = 25 °C and V_I = 3.6 V.

[2] When operating in an extended input voltage range, the device will be fully functional but has a reduced performance specification on certain parameters. An extended input voltage range is entered when the input voltage is dropping below 3.0 V, assuming the device is not in undervoltage lockout mode.

[3] When no external resistor is connected, the device will apply a default current setting. See [Section 8.3](#) for details. Corresponding pins should then be connected to high (> 1.4 V)

[4] Higher resistor values than the maximum are considered as no resistor is connected and therefore result in the default current setting.

[5] Lower resistor values than the minimum will result in large currents being drawn from the device resulting in bad operation.

[6] To accommodate two LEDs with a spread in V_F between 2.7 V and 4.3 V each.

[7] Only valid in Boost mode: typically in a dual LED configuration. When in linear mode, used in specific cases of single LED applications, excess voltage will fall over the LED pin.

13. Package outline

HVQFN16: plastic thermal enhanced very thin quad flat package; no leads; 16 terminals; body 3 x 3 x 0.85 mm

SOT758-3

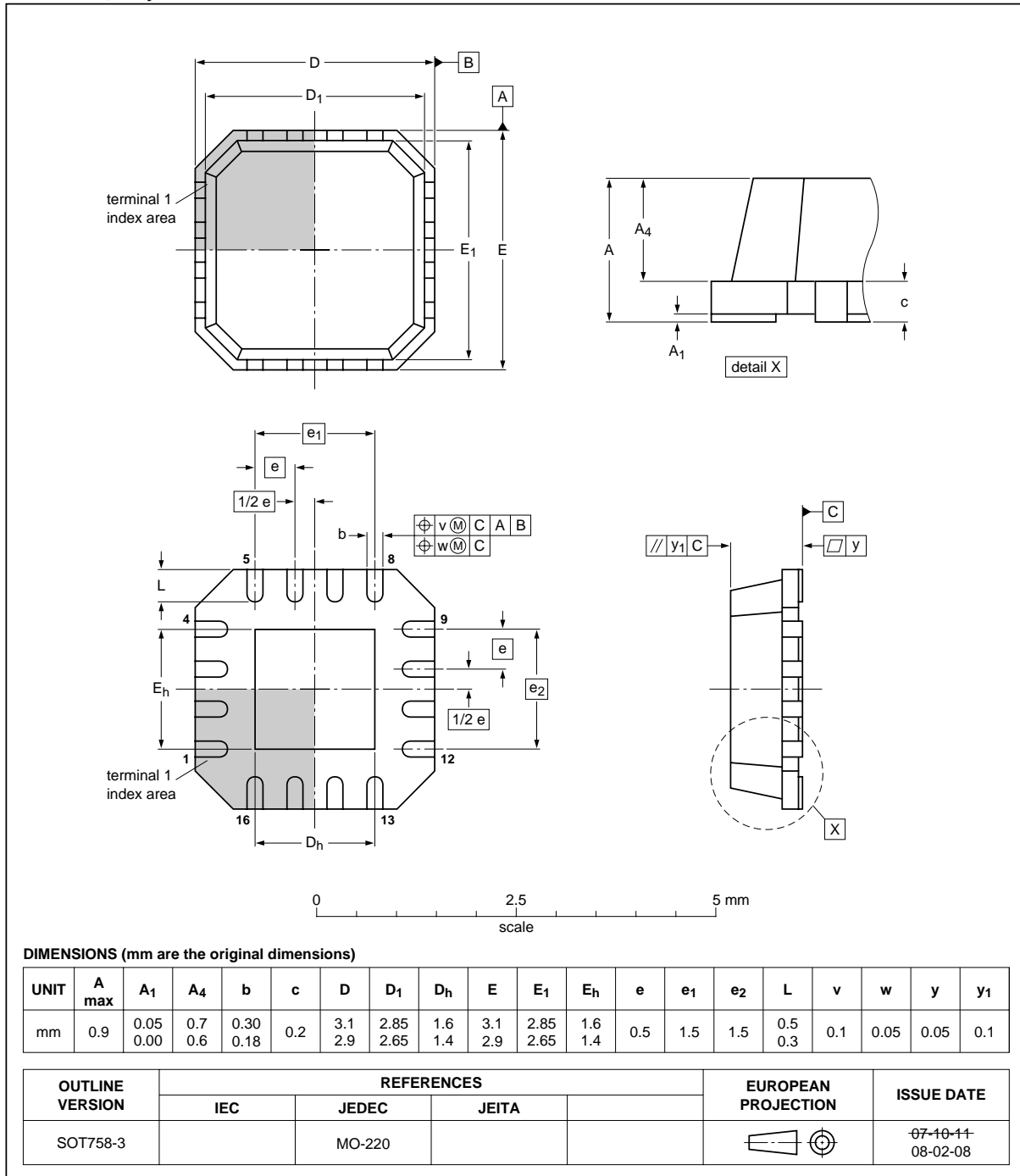

Fig 15. Package outline SOT758-3 (HVQFN16)

14. Abbreviations

Table 10. Abbreviations

Abbreviation	Description
EMI	ElectroMagnetic Interference
ESR	Equivalent Series Resistance
IC	Integrated Circuit
IO	Input/Output
LED	Light Emitting Diode
MOSFET	Metal-Oxide Semiconductor Field-Effect Transistor
NMOS	N-type Metal-Oxide Semiconductor
PDA	Personal Digital Assistants
PWM	Pulse Width Modulation
RF	Radio Frequency

15. Revision history

Table 11. Revision history

Document ID	Release date	Data sheet status	Change notice	Supersedes
SSL3250A_3	20090630	Product data sheet	-	SSL3250A_2
Modifications:	<ul style="list-style-type: none"> • Section 4.1 "Ordering options": removed orderable part number SSL3250AHN/C1,518 • Section 5 "Marking": removed (old) Figure 1 "SSL3250AHN/C1,518 with pin 1 according to EIA-481-C in quadrant 1" 			
SSL3250A_2	20090421	Product data sheet	-	SSL3250A_1
SSL3250A_1	20090205	Product data sheet	-	-

16. Legal information

16.1 Data sheet status

Document status ^{[1][2]}	Product status ^[3]	Definition
Objective [short] data sheet	Development	This document contains data from the objective specification for product development.
Preliminary [short] data sheet	Qualification	This document contains data from the preliminary specification.
Product [short] data sheet	Production	This document contains the product specification.

[1] Please consult the most recently issued document before initiating or completing a design.

[2] The term 'short data sheet' is explained in section "Definitions".

[3] The product status of device(s) described in this document may have changed since this document was published and may differ in case of multiple devices. The latest product status information is available on the Internet at URL <http://www.nxp.com>.

16.2 Definitions

Draft — The document is a draft version only. The content is still under internal review and subject to formal approval, which may result in modifications or additions. NXP Semiconductors does not give any representations or warranties as to the accuracy or completeness of information included herein and shall have no liability for the consequences of use of such information.

Short data sheet — A short data sheet is an extract from a full data sheet with the same product type number(s) and title. A short data sheet is intended for quick reference only and should not be relied upon to contain detailed and full information. For detailed and full information see the relevant full data sheet, which is available on request via the local NXP Semiconductors sales office. In case of any inconsistency or conflict with the short data sheet, the full data sheet shall prevail.

16.3 Disclaimers

General — Information in this document is believed to be accurate and reliable. However, NXP Semiconductors does not give any representations or warranties, expressed or implied, as to the accuracy or completeness of such information and shall have no liability for the consequences of use of such information.

Right to make changes — NXP Semiconductors reserves the right to make changes to information published in this document, including without limitation specifications and product descriptions, at any time and without notice. This document supersedes and replaces all information supplied prior to the publication hereof.

Suitability for use — NXP Semiconductors products are not designed, authorized or warranted to be suitable for use in medical, military, aircraft, space or life support equipment, nor in applications where failure or malfunction of an NXP Semiconductors product can reasonably be expected to result in personal injury, death or severe property or environmental

damage. NXP Semiconductors accepts no liability for inclusion and/or use of NXP Semiconductors products in such equipment or applications and therefore such inclusion and/or use is at the customer's own risk.

Applications — Applications that are described herein for any of these products are for illustrative purposes only. NXP Semiconductors makes no representation or warranty that such applications will be suitable for the specified use without further testing or modification.

Limiting values — Stress above one or more limiting values (as defined in the Absolute Maximum Ratings System of IEC 60134) may cause permanent damage to the device. Limiting values are stress ratings only and operation of the device at these or any other conditions above those given in the Characteristics sections of this document is not implied. Exposure to limiting values for extended periods may affect device reliability.

Terms and conditions of sale — NXP Semiconductors products are sold subject to the general terms and conditions of commercial sale, as published at <http://www.nxp.com/profile/terms>, including those pertaining to warranty, intellectual property rights infringement and limitation of liability, unless explicitly otherwise agreed to in writing by NXP Semiconductors. In case of any inconsistency or conflict between information in this document and such terms and conditions, the latter will prevail.

No offer to sell or license — Nothing in this document may be interpreted or construed as an offer to sell products that is open for acceptance or the grant, conveyance or implication of any license under any copyrights, patents or other industrial or intellectual property rights.

Export control — This document as well as the item(s) described herein may be subject to export control regulations. Export might require a prior authorization from national authorities.

16.4 Trademarks

Notice: All referenced brands, product names, service names and trademarks are the property of their respective owners.

I²C-bus — logo is a trademark of NXP B.V.

17. Contact information

For more information, please visit: <http://www.nxp.com>

For sales office addresses, please send an email to: salesaddresses@nxp.com

18. Contents

1	General description	1	13	Package outline	23
2	Features	1	14	Abbreviations	24
3	Applications	2	15	Revision history	24
4	Ordering information	2	16	Legal information	25
4.1	Ordering options	2	16.1	Data sheet status	25
5	Marking	2	16.2	Definitions	25
6	Block diagram	3	16.3	Disclaimers	25
7	Pinning information	4	16.4	Trademarks	25
7.1	Pinning	4	17	Contact information	25
7.2	Pin description	4	18	Contents	26
8	Functional description	5			
8.1	Introduction	5			
8.2	Interface modes	5			
8.2.1	Using the direct enable control	6			
8.2.2	Using the I ² C control	6			
8.3	Operational modes	7			
8.3.1	Shut-down mode	7			
8.3.2	Standby mode	7			
8.3.3	Torch mode	7			
8.3.4	Flash mode	9			
8.3.5	Timed Flash mode	10			
8.3.6	Flash mode during RF transmit	10			
8.3.7	Indicator LED	11			
8.4	Protection circuits	12			
8.4.1	Overvoltage protection	13			
8.4.2	Untimed Flash mode	13			
8.4.3	Overtemperature protection	13			
8.4.4	Short circuit protection	14			
8.4.5	Interrupt line	14			
8.4.6	Undervoltage lockout	14			
8.5	Soft start	14			
8.6	Peak current limit	14			
8.7	I ² C-bus protocol	14			
8.7.1	Addressing	16			
8.7.2	Data	16			
8.7.3	Register map	16			
9	Application design-in information	17			
9.1	Input capacitor	17			
9.2	Output capacitor	17			
9.3	Inductor	18			
9.4	Rectifier diode	18			
9.5	PCB layout	18			
10	Limiting values	19			
11	Thermal characteristics	20			
12	Characteristics	20			

Please be aware that important notices concerning this document and the product(s) described herein, have been included in section 'Legal information'.



© NXP B.V. 2009.

All rights reserved.

For more information, please visit: <http://www.nxp.com>

For sales office addresses, please send an email to: salesaddresses@nxp.com

Date of release: 30 June 2009

Document identifier: SSL3250A_3