

# Switch Mode Power Supply S82S (3/7.5-W Models)

CSM\_S82S\_DS\_E\_2\_1

## Miniature DIN Rail Mounting DC-DC Power Supplies

- 65 mm depth enables mounting onto control panels with 100 mm depth.
- Inputs: 10.2 to 27.6 VDC (DC input)
- 7.5-W models provide both  $\pm 12$ -V and  $\pm 15$ -V outputs.
- A complete lineup with 10 different models.
- UL and CSA approved.
- RoHS-compliant



 Refer to *Safety Precautions for All Power Supplies*.

## Model Number Structure

### Model Number Legend

**Note:** Not all combinations are possible. Please refer to *List of Models in Ordering Information*, below.

S82S -     
          1    2    3

#### 1. Input Voltage

7: 12 to 24 VDC

#### 2. Power Ratings

3: 3 W

7: 7.5 W

#### 3. Output Voltage

05: 5 V

12: 12 V

15: 15 V

24: 24 V

27:  $\pm 12$  V

28:  $\pm 15$  V

## Ordering Information

### List of Models

**Note:** For details on normal stock models, contact your nearest OMRON representative.

Power ratings	Output voltage	Output current	Model
3 W	5 V	0.6 A	S82S-7305
	12 V	0.25 A	S82S-7312
	15 V	0.2 A	S82S-7315
	24 V	0.13 A	S82S-7324
7.5 W	5 V	1.5 A	S82S-7705
	12 V	0.6 A	S82S-7712
	15 V	0.5 A	S82S-7715
	24 V	0.3 A	S82S-7724
	$\pm 12$ V	0.3 A (+12 V)/0.2 A (-12 V)	S82S-7727
	$\pm 15$ V	0.2 A (+15V)/0.2A (-15 V)	S82S-7728

# Specifications

## ■ Ratings/Characteristics

Item			DC input		
			3 W	Single output 7.5 W	Dual Output 7.5 W
Efficiency (typical)			60% to 73% (Varies with specifications.)		
Input	Voltage	AC	No		
		DC	10.2 to 27.6 VDC		
	Current (See note 1.)		0.6 A max.	1.2 A max.	
	Noise filter		Yes		
Output (See note 2.)	Voltage adjustment range		±5% (See note 3.)		None (See note 4.)
	Ripple (See note 1.)		2% (p-p) max.		
	Input variation influence		0.5% max. (10.2 to 27.6 VDC input, 100% load)		
	Load variation influence		1.5% max.		+V: 1.5% max. -V: 3% max.
	Temperature variation influence		0.05%/°C max.		
Additional function	Overload protection (See note 5.)		105% min. of rated load current, voltage drop, automatic reset		
Other	Ambient operating temperature		Refer to the derating curve in <i>Engineering Data</i>		
	Storage temperature		-25 to 65°C		
	Ambient operating humidity		25% to 85% (storage humidity: 20% to 90%)		
	Dielectric strength		2.0 kVAC, 50/60Hz for 1 min. (between all inputs and outputs/PE terminal)		1.5 kVAC, 50/60Hz for 1 min. (between all inputs and outputs/PE terminal)
	Insulation resistance		100 MΩ min. at 500 VDC (between all outputs and inputs/PE terminal)		
	Vibration resistance		10 to 55 Hz, 0.375-mm single amplitude for 2 hours each in X, Y, and Z directions		
	Shock resistance		294 m/s <sup>2</sup> , 3 times each in ±X, ±Y, ±Z directions		
	Output indicator		Yes (color: green)		
	Approved standards		Refer to <i>List of Certified Models</i> for details.		
	Weight		150 g max.		

**Note:** 1. A 100% load for rated input voltage.

2. Output characteristics are measured at the power supply output terminals.

3. If the output voltage adjuster (V.ADJ) is turned, the voltage will increase by more than 50% of the voltage adjustment range. When adjusting the output voltage, confirm the actual output voltage from the Power Supply and be sure that the load is not damaged.

4. The settings for the output voltage must be within the following range:

+V: ±1% of the rated value

-V: ±5% of the rated value

5. Refer to *Overload Protection* on page 4 for details.

# Connections

## ■ Block Diagrams

### Single Output

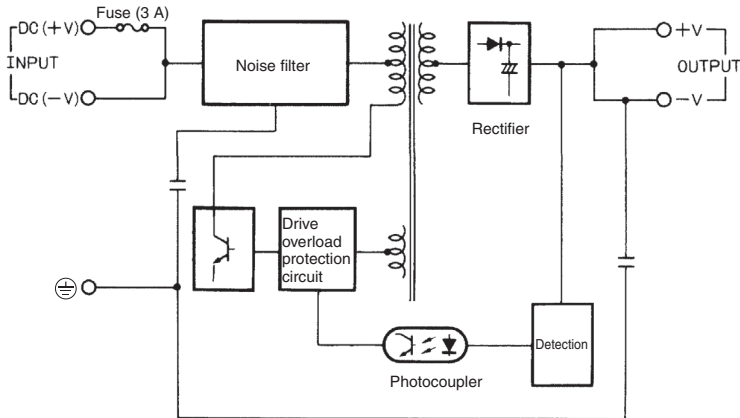

### Dual Outputs

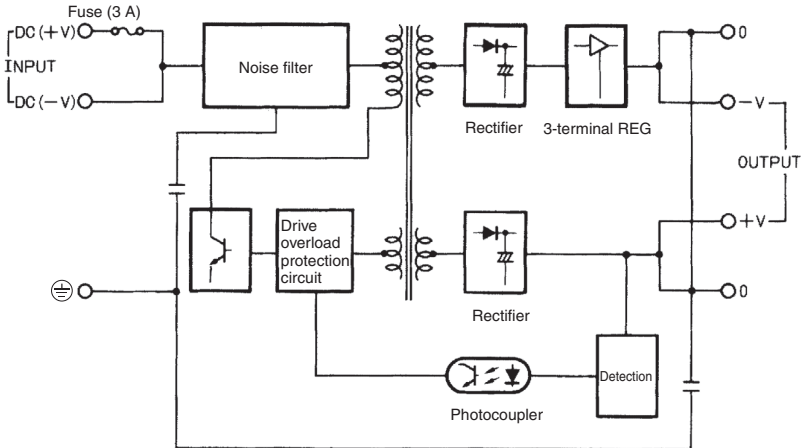

# Construction and Nomenclature

## ■ Nomenclature

### Terminal Arrangement

Single Output Models

Dual Output Models

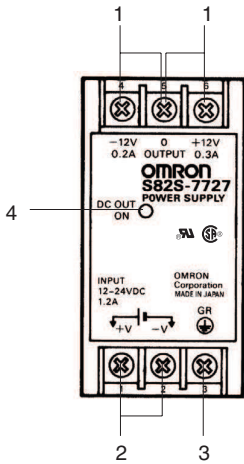
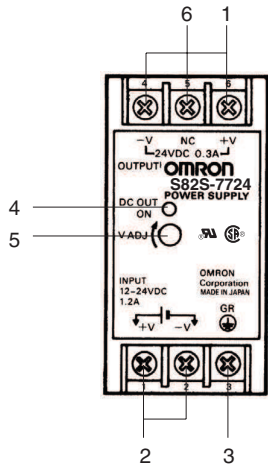

1. **DC Output Terminals:** Connect the load lines to these terminals.
2. **Input Terminals:** Connect the input lines to these terminals.
- Note:** The fuse is located on the (+V) side. It is NOT user replaceable.
3. **Protective earthing terminal:** Connect a ground line to this terminal.
4. **Output LED Indicator (DC OUT ON):** Lights while a DC output is ON (for the Dual Output Models, this indicator is lit when the +V DC output is ON).
5. **Output voltage adjuster (V. ADJ.):** Use to adjust the output voltage.
6. **NC Terminals:** Vacant terminals.

# Engineering Data

## Derating Curve

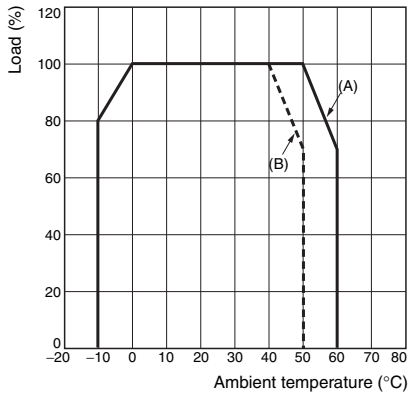

**Note:** The derating curve depends on the mounting direction of the Power Supply

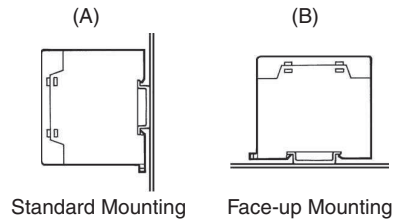

## Overload Protection

The power supply is provided with an overload protection function that protects the Power Supply from possible damage by overcurrent. When the output current rises to 105% or higher of the rated current, the protection function is triggered, automatically decreasing the output voltage. When the output current falls within the rated range, the overload protection function is automatically cleared.

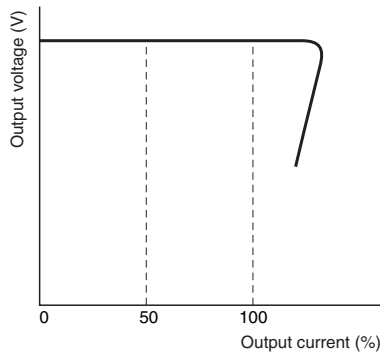

The values shown in the above diagram are for reference only.

**Note:** Internal parts may occasionally deteriorate or be damaged if a short-circuit or other overcurrent state continues during operation. Eliminate the overcurrent state as soon as possible.

## Dual Output Models

The total output power for the +V output and -V output is detected for the protection operation (i.e., total overcurrent protection), but this condition varies depending on -V output status. -V output has an independent short-circuit protection feature.

## Inrush Current, Startup Time, Hold Time

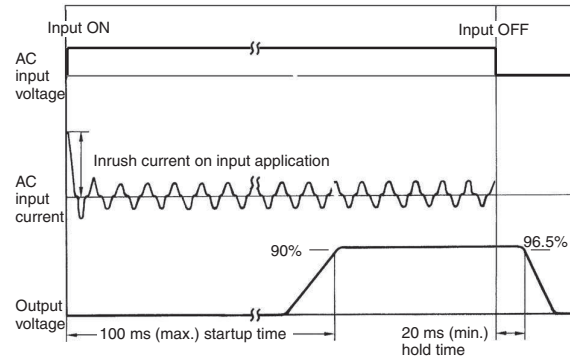

# Dimensions

Note: All units are in millimeters unless otherwise indicated.

S82S-73□□ (3W)  
S82S-77□□ (7.5W)

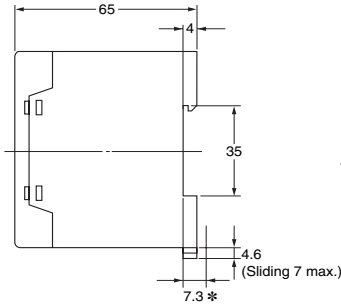
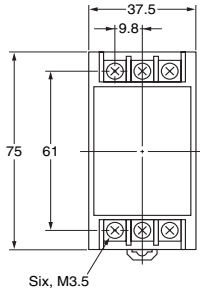
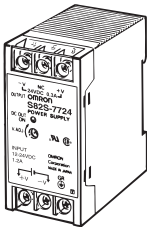

### Mounting Holes

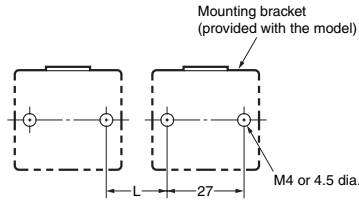

Note: If more than one Power Supply is installed in a row, keep a distance of 20 mm min. (L = 20 mm min.) between each adjacent Power Supply.

\* A distance of 7.3 mm is required between the model and the mounting surface when the mounting bracket provided with the model is used.

## Accessories

Note: All units are in millimeters unless otherwise indicated.

### Mounting Bracket

Used when not mounting the Power Supply directly on the DIN Rail.

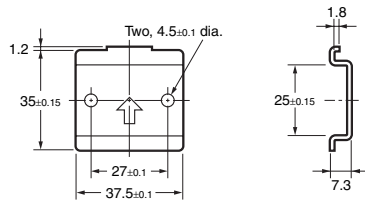

## DIN Rail (Order Separately)

### Mounting Rail (Material: Aluminum)

PFP-100N  
PFP-50N

PFP-100N2

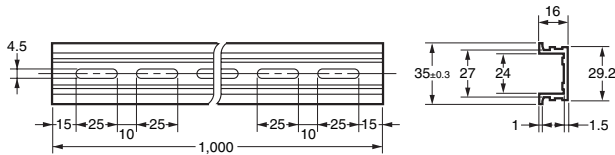
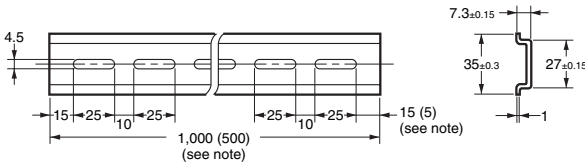
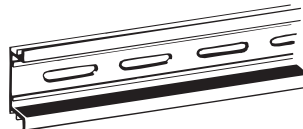
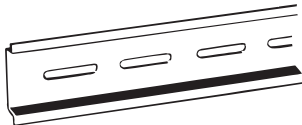

Note: The values shown in parentheses are for the PFP-50N.

# Safety Precautions

## CAUTION

Minor electric shock, fire, or Product failure may occasionally occur. Do not disassemble, modify, or repair the Product or touch the interior of the Product.



Minor burns may occasionally occur. Do not touch the Product while power is being supplied or immediately after power is turned OFF.



Fire may occasionally occur. Tighten terminal screws to the specified torque of 0.74 N·m (M3.5).



Minor injury due to electric shock may occasionally occur. Do not touch the terminals while power is being supplied.



Minor electric shock, fire, or Product failure may occasionally occur. Do not allow any pieces of metal or conductors or any clippings or cuttings resulting from installation work to enter the Product.



## Mounting

To improve and maintain the reliability of the power supply over a long period of time, adequate consideration must be given to heat radiation.

The power supply is designed to radiate heat by means of natural air-flow. Therefore, mount the power supply so that air flow takes place around the power supply.

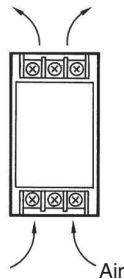

When mounting two or more power supplies side-by-side, allow at least 10 mm spacing between them, as shown in the following diagram.

Forced air-cooling is recommended.

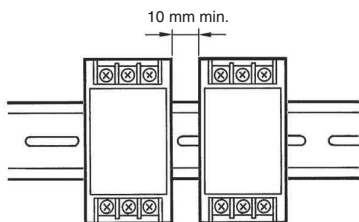

## Wiring

Do not apply more than 75-N force to the terminal block when tightening it.

## DIN Rail Mounting

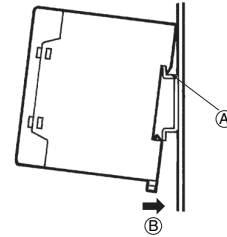

When mounting to a DIN Rail, lower the S82S onto the Rail until the Rail stopper clicks into space, hook section A over the edge of the Rail, and push in the direction of B.

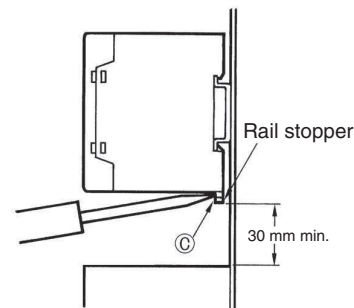

To remove the S82S from the DIN Rail, insert a screwdriver into section C and pull the S82S away from the Rail.

## Serial or Parallel Operation

No serial or parallel operation is available.

The positive and negative output terminals of a Dual Output Model cannot be connected in series to operate.

### Incorrect

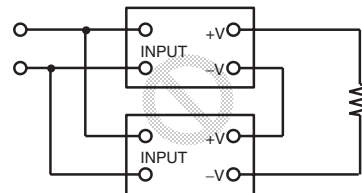

### Incorrect

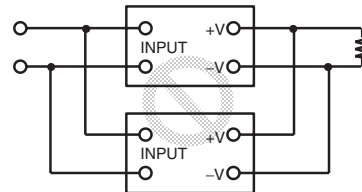

## Minimum Output Current

### (S82S-7727 and S82S-7728)

The minimum output current of the S82S-7727 and S82S-7728 is restricted by the output voltage and control method.

**Note:** All the outputs of the S82S-7727 and S82S-7728 are controlled by the +V output. If the +V output current falls to 10% or less of the rated output, the -V output voltage may drop.

ALL DIMENSIONS SHOWN ARE IN MILLIMETERS.

To convert millimeters into inches, multiply by 0.03937. To convert grams into ounces, multiply by 0.03527.

In the interest of product improvement, specifications are subject to change without notice.

## Read and Understand This Catalog

Please read and understand this catalog before purchasing the products. Please consult your OMRON representative if you have any questions or comments.

## Warranty and Limitations of Liability

### WARRANTY

OMRON's exclusive warranty is that the products are free from defects in materials and workmanship for a period of one year (or other period if specified) from date of sale by OMRON.

OMRON MAKES NO WARRANTY OR REPRESENTATION, EXPRESS OR IMPLIED, REGARDING NON-INFRINGEMENT, MERCHANTABILITY, OR FITNESS FOR PARTICULAR PURPOSE OF THE PRODUCTS. ANY BUYER OR USER ACKNOWLEDGES THAT THE BUYER OR USER ALONE HAS DETERMINED THAT THE PRODUCTS WILL SUITABLY MEET THE REQUIREMENTS OF THEIR INTENDED USE. OMRON DISCLAIMS ALL OTHER WARRANTIES, EXPRESS OR IMPLIED.

### LIMITATIONS OF LIABILITY

OMRON SHALL NOT BE RESPONSIBLE FOR SPECIAL, INDIRECT, OR CONSEQUENTIAL DAMAGES, LOSS OF PROFITS OR COMMERCIAL LOSS IN ANY WAY CONNECTED WITH THE PRODUCTS, WHETHER SUCH CLAIM IS BASED ON CONTRACT, WARRANTY, NEGLIGENCE, OR STRICT LIABILITY.

In no event shall the responsibility of OMRON for any act exceed the individual price of the product on which liability is asserted.

IN NO EVENT SHALL OMRON BE RESPONSIBLE FOR WARRANTY, REPAIR, OR OTHER CLAIMS REGARDING THE PRODUCTS UNLESS OMRON'S ANALYSIS CONFIRMS THAT THE PRODUCTS WERE PROPERLY HANDLED, STORED, INSTALLED, AND MAINTAINED AND NOT SUBJECT TO CONTAMINATION, ABUSE, MISUSE, OR INAPPROPRIATE MODIFICATION OR REPAIR.

## Application Considerations

### SUITABILITY FOR USE

OMRON shall not be responsible for conformity with any standards, codes, or regulations that apply to the combination of products in the customer's application or use of the products.

At the customer's request, OMRON will provide applicable third party certification documents identifying ratings and limitations of use that apply to the products. This information by itself is not sufficient for a complete determination of the suitability of the products in combination with the end product, machine, system, or other application or use.

The following are some examples of applications for which particular attention must be given. This is not intended to be an exhaustive list of all possible uses of the products, nor is it intended to imply that the uses listed may be suitable for the products:

- Outdoor use, uses involving potential chemical contamination or electrical interference, or conditions or uses not described in this catalog.
- Nuclear energy control systems, combustion systems, railroad systems, aviation systems, medical equipment, amusement machines, vehicles, safety equipment, and installations subject to separate industry or government regulations.
- Systems, machines, and equipment that could present a risk to life or property.

Please know and observe all prohibitions of use applicable to the products.

NEVER USE THE PRODUCTS FOR AN APPLICATION INVOLVING SERIOUS RISK TO LIFE OR PROPERTY WITHOUT ENSURING THAT THE SYSTEM AS A WHOLE HAS BEEN DESIGNED TO ADDRESS THE RISKS, AND THAT THE OMRON PRODUCTS ARE PROPERLY RATED AND INSTALLED FOR THE INTENDED USE WITHIN THE OVERALL EQUIPMENT OR SYSTEM.

### PROGRAMMABLE PRODUCTS

OMRON shall not be responsible for the user's programming of a programmable product, or any consequence thereof.

## Disclaimers

### CHANGE IN SPECIFICATIONS

Product specifications and accessories may be changed at any time based on improvements and other reasons.

It is our practice to change model numbers when published ratings or features are changed, or when significant construction changes are made. However, some specifications of the products may be changed without any notice. When in doubt, special model numbers may be assigned to fix or establish key specifications for your application on your request. Please consult with your OMRON representative at any time to confirm actual specifications of purchased products.

### DIMENSIONS AND WEIGHTS

Dimensions and weights are nominal and are not to be used for manufacturing purposes, even when tolerances are shown.

### PERFORMANCE DATA

Performance data given in this catalog is provided as a guide for the user in determining suitability and does not constitute a warranty. It may represent the result of OMRON's test conditions, and the users must correlate it to actual application requirements. Actual performance is subject to the OMRON Warranty and Limitations of Liability.

### ERRORS AND OMISSIONS

The information in this document has been carefully checked and is believed to be accurate; however, no responsibility is assumed for clerical, typographical, or proofreading errors, or omissions.

2008.12

In the interest of product improvement, specifications are subject to change without notice.

**OMRON Corporation**  
Industrial Automation Company

<http://www.ia.omron.com/>

(c)Copyright OMRON Corporation 2008 All Right Reserved.