

## Micro-Power Voltage Detectors

### General Description

The RT9819 is a micro-power voltage detector supervising the power supply voltage level for microprocessors ( $\mu$ P) or digital systems. It provides internally fixed threshold levels with 0.1V per step ranging from 1.2V to 5V, which covers most digital applications. It features low supply current of 3 $\mu$ A. The RT9819 performs supervisory function by sending out a reset signal whenever the  $V_{DD}$  voltage falls below a preset threshold level. This reset signal will last the whole period before  $V_{DD}$  recovering. Once  $V_{DD}$  recovered upcrossing the threshold level, the reset signal will be released after a certain delay time. RT9819 is provided in SC-70-3, SC-82 and SOT-23-3 packages.

### Ordering Information

RT9819□-□□□□

- Package Type
  - U3 : SC-70-3
  - V : SOT-23-3
  - VL : SOT-23-3 (L-Type)
  - Y : SC-82
  - YR : SC-82 (R-Type)
- Lead Plating System
  - P : Pb Free
  - G : Green (Halogen Free and Pb Free)
- Threshold Voltage
  - 12 : 1.2V
  - 13 : 1.3V
  - :
  - 49 : 4.9V
  - 50 : 5.0V
- Reset Active Timeout Period
  - A = 0ms ( $\overline{\text{RESET}}$ )
  - B = 55ms ( $\overline{\text{RESET}}$ )
  - C = 220ms ( $\overline{\text{RESET}}$ )
  - D = 450ms ( $\overline{\text{RESET}}$ )
  - E = 0ms ( $\text{RESET}$ )
  - F = 55ms ( $\text{RESET}$ )
  - G = 220ms ( $\text{RESET}$ )
  - H = 450ms ( $\text{RESET}$ )

Note :

Richtek products are :

- ▶ RoHS compliant and compatible with the current requirements of IPC/JEDEC J-STD-020.
- ▶ Suitable for use in SnPb or Pb-free soldering processes.

### Features

- Internally Fixed Threshold 1.2V to 5V in 0.1V Step
- High Accuracy  $\pm 1.5\%$
- Low Supply Current 3 $\mu$ A
- No External Components Required
- Quick Reset within 20 $\mu$ s
- Built-in Recovery Delay Include 0ms, 55ms, 220ms, 450ms Options
- Low Functional Supply Voltage 0.9V
- CMOS Push-Pull Output
- Small SC-70-3, SC-82 and SOT-23-3 Packages
- RoHS Compliant and 100% Lead (Pb)-Free

### Applications

- Computers
- Controllers
- Intelligent Instruments
- Critical  $\mu$ P and  $\mu$ C Power Monitoring
- Portable/Battery-Powered Equipment

### Typical Application Circuit

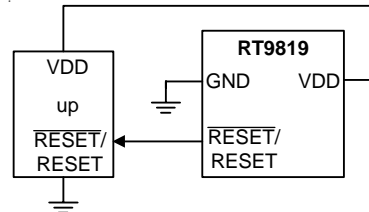

### Marking Information

For marking information, contact our sales representative directly or through a Richtek distributor located in your area.

## Pin Configurations

(TOP VIEW)

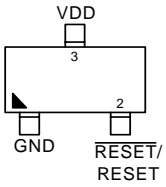

SC-70-3

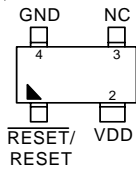

SC-82

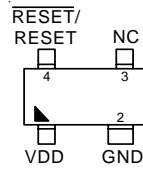

SC-82 (R-Type)

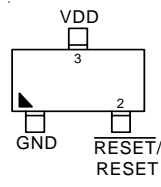

SOT-23-3

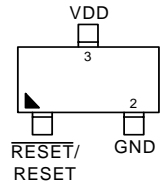

SOT-23-3 (L-Type)

## Functional Pin Description

Pin Name	Pin Function
GND	Ground
$\overline{\text{RESET}}$	Active Low Push-Pull Reset Output
RESET	Active High Push-Pull Reset Output
VDD	Power Pin

## Function Block Diagram

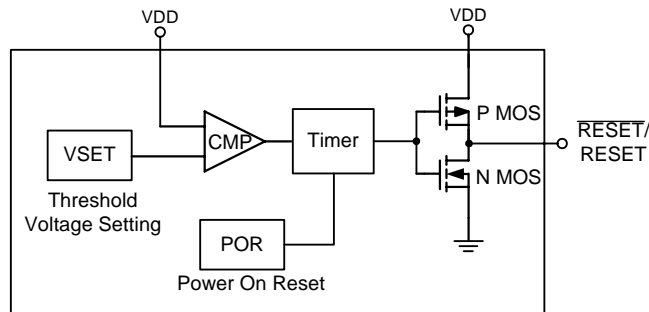

**Absolute Maximum Ratings** (Note 1)

- Terminal Voltage (with Respect to GND)  
 $V_{DD}$  ----- -0.3V to 6.0V
- All Other Inputs ----- -0.3V to  $V_{DD}+0.3V$
- Input Current,  $I_{VDD}$  ----- 20mA
- Power Dissipation, PD @  $T_A = 25^\circ C$   
 $SC-70-3/SC-82$  ----- 0.25W  
 $SOT-23-3$  ----- 0.4W
- Package Thermal Resistance (Note 2)  
 $SC-70-3/SC-82, \theta_{JA}$  -----  $400^\circ C/W$   
 $SOT-23-3, \theta_{JA}$  -----  $250^\circ C/W$
- Lead Temperature (Soldering, 10sec.) -----  $260^\circ C$
- Storage Temperature Range -----  $-65^\circ C$  to  $125^\circ C$
- ESD Susceptibility (Note 3)  
 HBM (Human Body Mode) ----- 2kV  
 MM (Machine Mode) ----- 200V

**Recommended Operating Conditions** (Note 4)

- Junction Temperature Range -----  $-40^\circ C$  to  $125^\circ C$
- Ambient Temperature Range -----  $-40^\circ C$  to  $85^\circ C$

**Electrical Characteristics**

( $V_{DD} = 3V, T_A = 25^\circ C$ , unless otherwise specified)

Parameter	Symbol	Test Conditions	Min	Typ	Max	Units
Operating $V_{DD}$ ( $V_{OUT}$ ) Range	$V_{DD}$	RT9819A/B/C/D	0.9	--	6	V
		RT9819E/F/G/H	1.1	--	6	
Supply Current	$I_{DD}$	$V_{TH} = 3V, V_{DD} = 4.5V$	--	3	8	$\mu A$
Reset Threshold	$V_{TH}$		--	1.2 to 5.0	--	V
Threshold Voltage Accuracy	$\Delta V_{TH}$		-1.5	--	+1.5	%
Threshold Voltage Hysteresis	$V_{HYS}$		--	$0.01 V_{TH}$	--	V
$V_{DD}$ Drop to Reset Delay	$t_{RD}$	Drop = $V_{TH} - 125mV$	--	20	--	$\mu s$
Reset Active Time Out Period	RT9819A/E	$V_{DD} \geq 1.02 \times V_{TH}$	--	0	--	ms
	RT9819B/F		35	55	75	ms
	RT9819C/G		143	220	297	ms
	RT9819D/H		292	450	608	ms
RESET Output Voltage Low	$V_{OL}$	$V_{DD} < V_{TH(MIN)}, I_{SINK} = 3.5mA, V_{TH} \geq 3V$	--	--	0.4	V
		$V_{DD} < V_{TH(MIN)}, I_{SINK} = 1.2mA, V_{TH} \geq 1.8V$	--	--	0.3	
		$V_{TH(MIN)} > V_{DD} > 1V, I_{SINK} = 0.5mA$	--	--	0.3	

*To be continued*

Parameter	Symbol	Test Conditions	Min	Typ	Max	Units
RESET Output Voltage High	V <sub>OH</sub>	V <sub>DD</sub> > V <sub>TH(MAX)</sub> , I <sub>SOURCE</sub> = 800μA, V <sub>TH</sub> ≥ 3V	V <sub>DD</sub> -1.5	--	--	V
		V <sub>DD</sub> > V <sub>TH(MAX)</sub> , I <sub>SOURCE</sub> = 500μA, V <sub>TH</sub> ≥ 1.8V	0.8 V <sub>DD</sub>	--	--	
		V <sub>DD</sub> > V <sub>TH(MAX)</sub> , I <sub>SOURCE</sub> = 200μA, V <sub>TH</sub> ≥ 1.1V	0.8 V <sub>DD</sub>	--	--	
RESET Output Voltage Low	V <sub>OL</sub>	V <sub>DD</sub> > V <sub>TH(MAX)</sub> , I <sub>SINK</sub> = 3.5mA, V <sub>TH</sub> ≥ 3V	--	--	0.4	V
		V <sub>DD</sub> > V <sub>TH(MAX)</sub> , I <sub>SINK</sub> = 1.2mA, V <sub>TH</sub> ≥ 1.8V	--	--	0.3	
		V <sub>DD</sub> > V <sub>TH(MAX)</sub> , I <sub>SINK</sub> = 0.5mA, V <sub>TH</sub> ≥ 1.2V	--	--	0.3	
RESET Output Voltage High	V <sub>OH</sub>	1.1V < V <sub>DD</sub> < V <sub>TH(MIN)</sub> , I <sub>SOURCE</sub> = 200μA	0.8 V <sub>DD</sub>	--	--	V
		1.8V < V <sub>DD</sub> < V <sub>TH(MIN)</sub> , I <sub>SOURCE</sub> = 500μA	0.8 V <sub>DD</sub>	--	--	
		3V < V <sub>DD</sub> < V <sub>TH(MIN)</sub> , I <sub>SOURCE</sub> = 800μA	V <sub>DD</sub> -1.5	--	--	

**Note 1.** Stresses listed as the above “Absolute Maximum Ratings” may cause permanent damage to the device. These are for stress ratings. Functional operation of the device at these or any other conditions beyond those indicated in the operational sections of the specifications is not implied. Exposure to absolute maximum rating conditions for extended periods may remain possibility to affect device reliability.

**Note 2.**  $\theta_{JA}$  is measured in the natural convection at T<sub>A</sub> = 25°C on a low effective thermal conductivity test board of JEDEC 51-3 thermal measurement standard.

**Note 3.** Devices are ESD sensitive. Handling precaution is recommended.

**Note 4.** The device is not guaranteed to function outside its operating conditions.

**Typical Operating Characteristics**

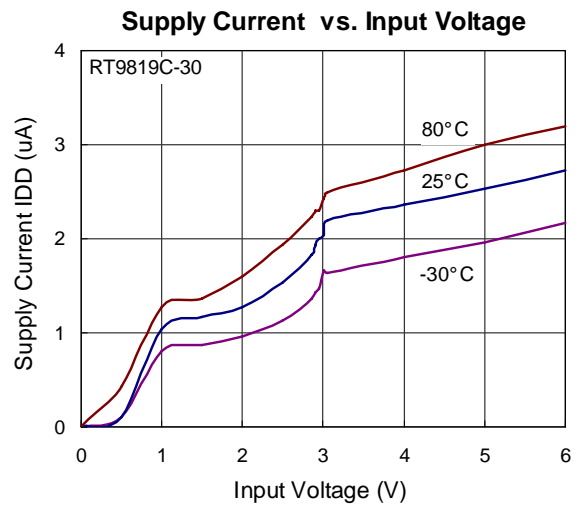
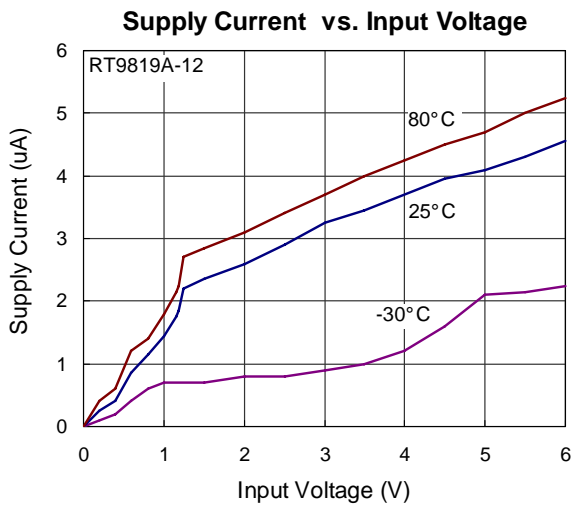
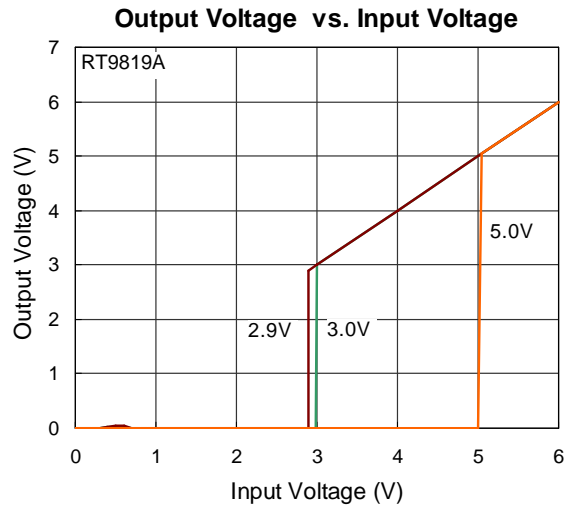
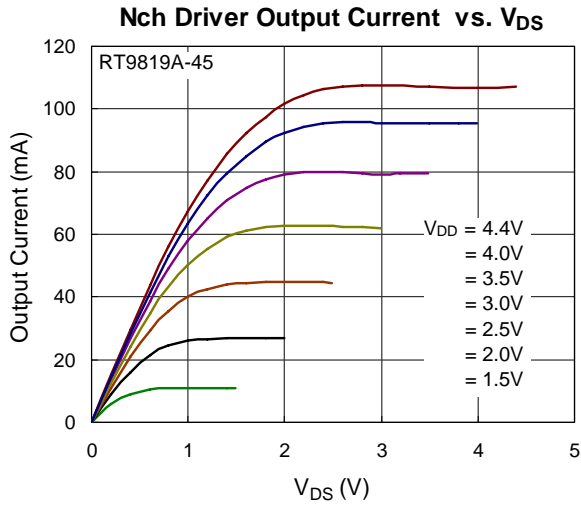
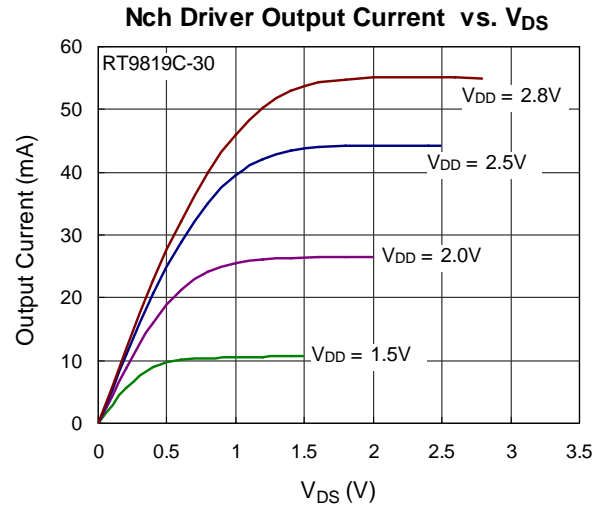
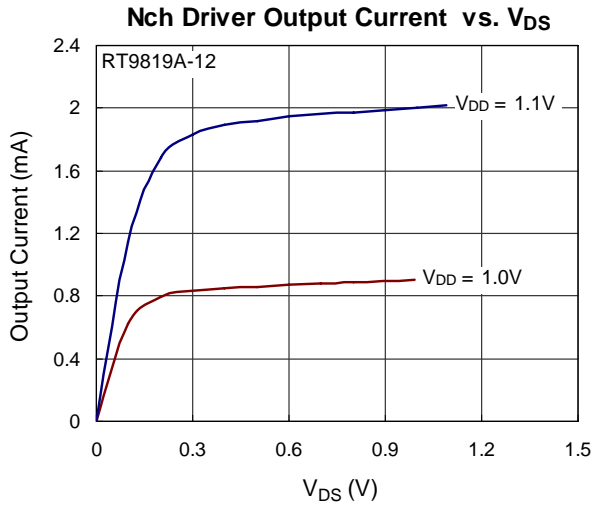

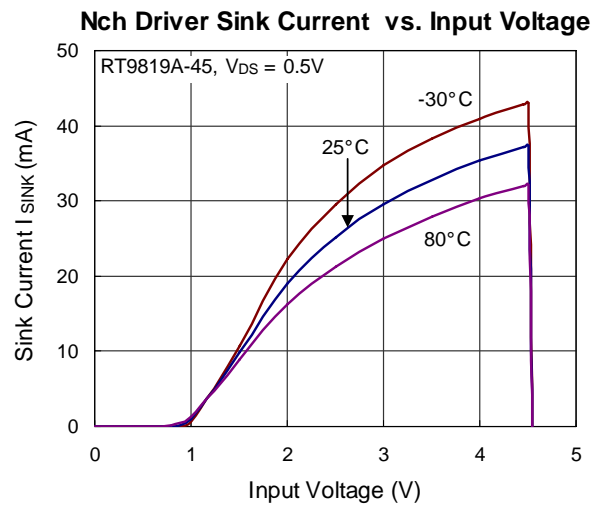
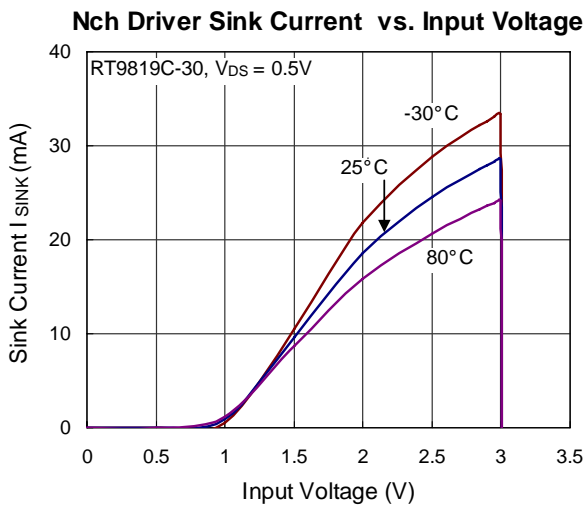
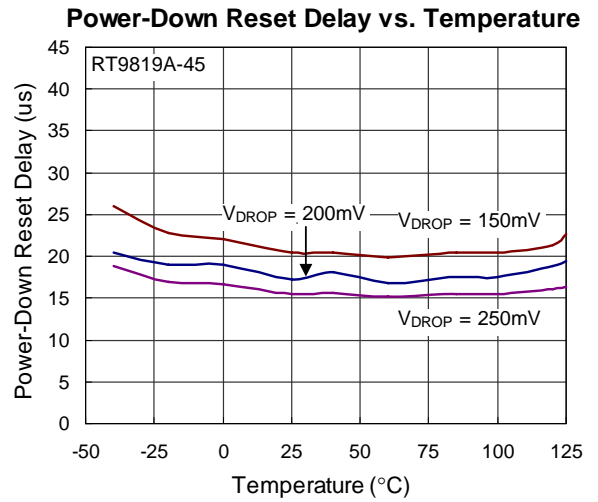
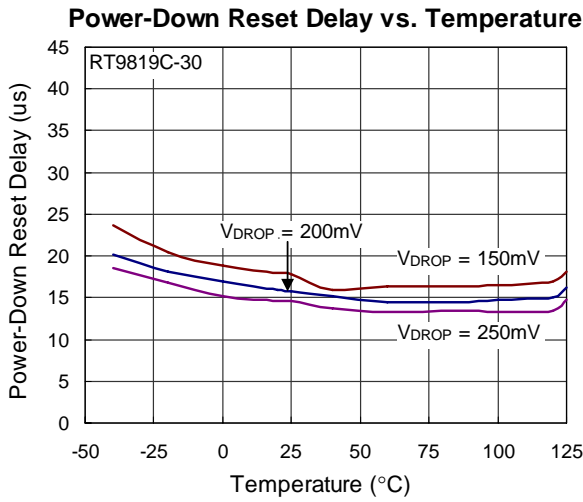
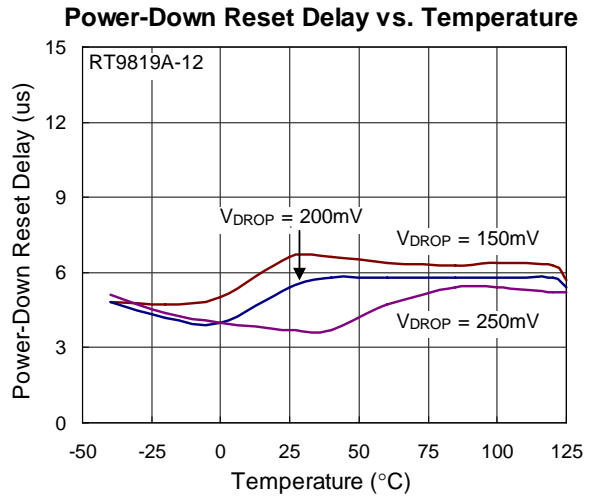
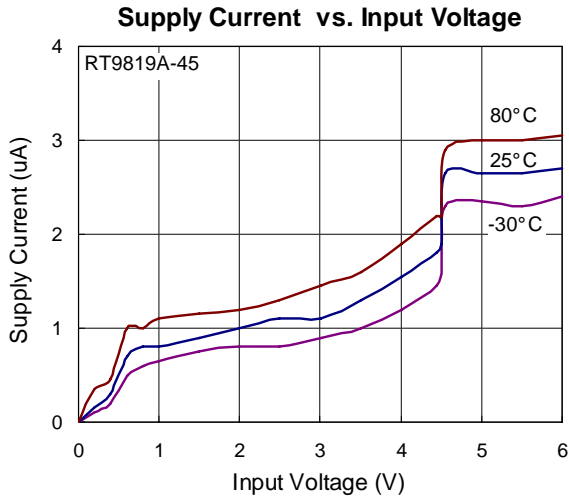

Reset Threshold Deviation vs. Temperature

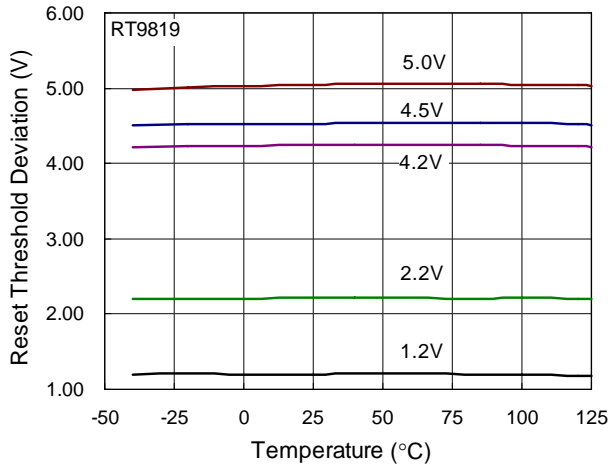

Pch Driver Output Current vs. Input Voltage

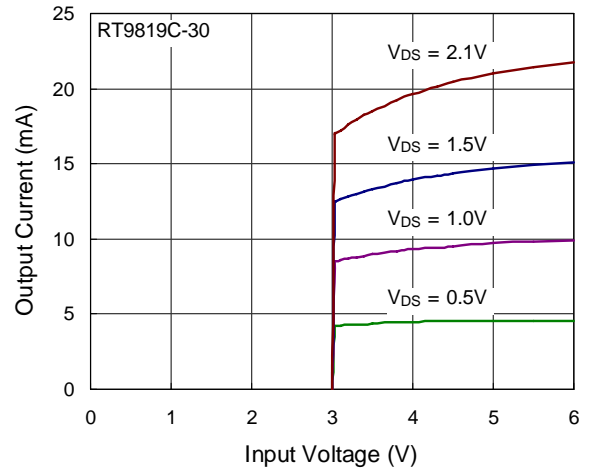

Power-Up Reset Time-Out vs. Temperature

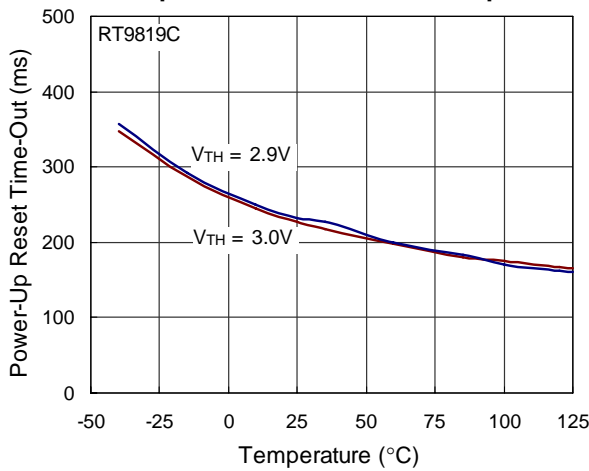

Power-Up Reset Time-Out vs. Temperature

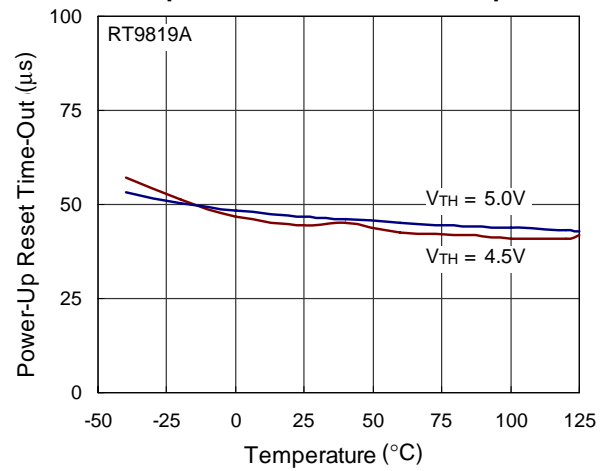

Output Delay Time vs. Load Capacitance

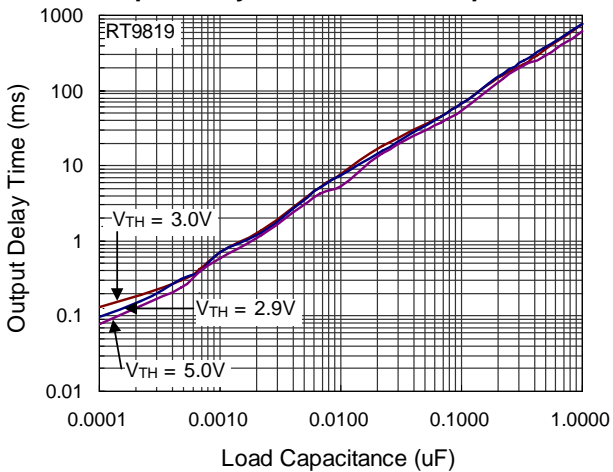

Nch Driver Output Current vs. V<sub>DS</sub>

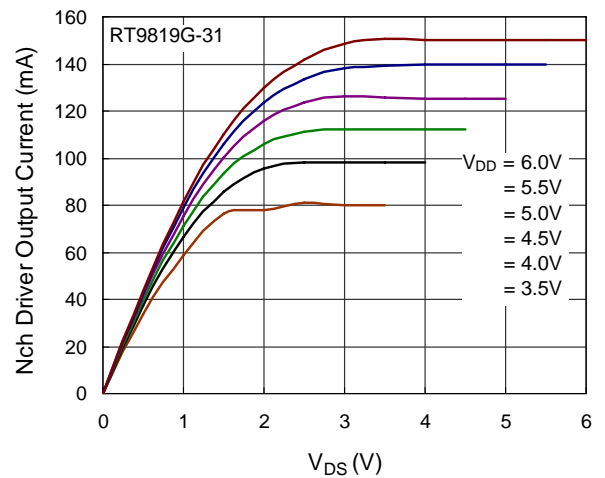

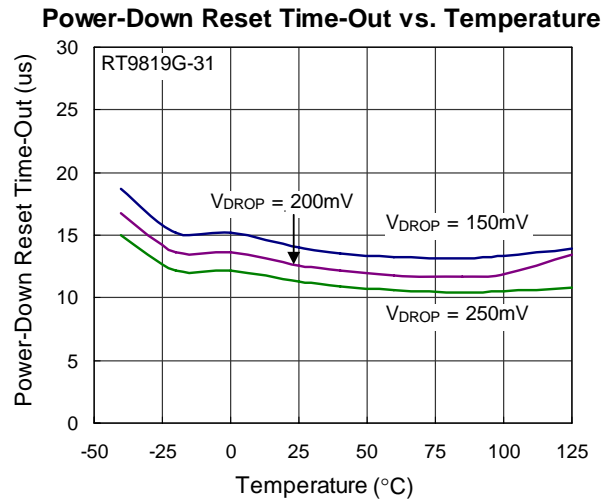
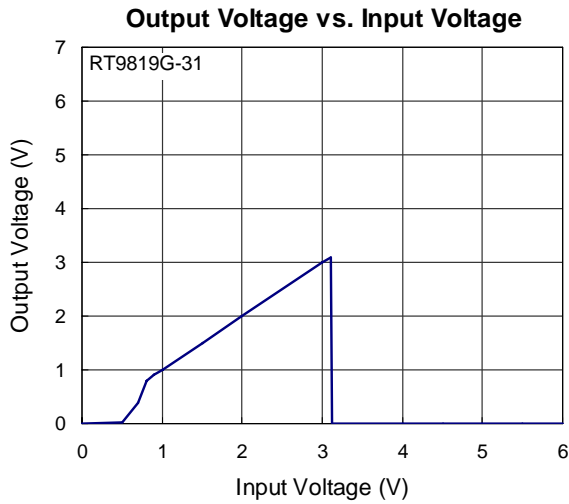
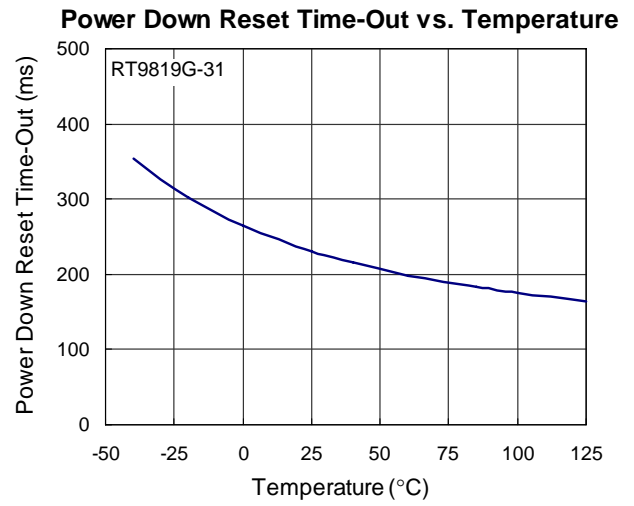
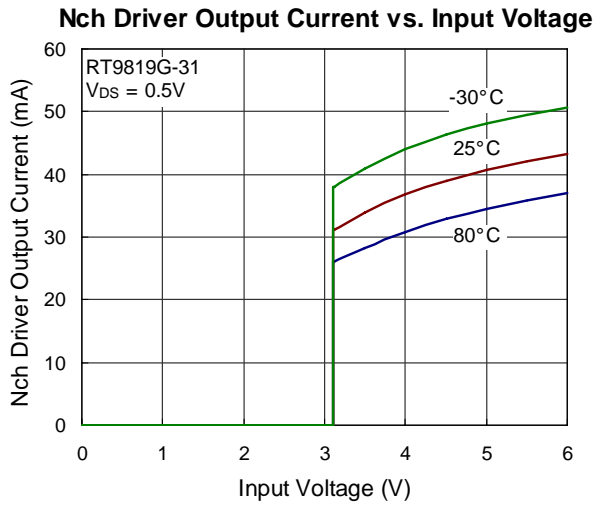



## Application Information

### Benefits of Highly Accurate Reset Threshold

Most  $\mu$ P supervisor ICs have reset threshold voltages between 1% and 1.5% below the value of nominal supply voltages. This ensures a reset will not occur within 1% of the nominal supply, but will occur when the supply is 1.5% below nominal.

Outline Dimension

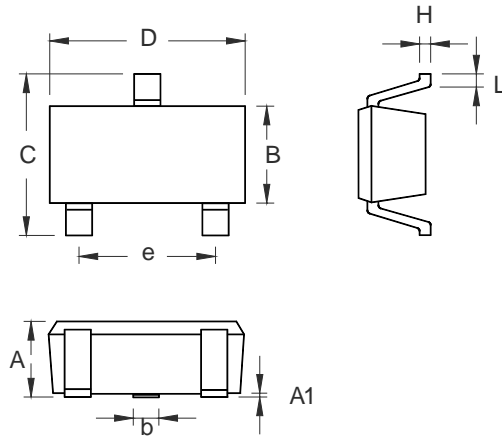

Symbol	Dimensions In Millimeters		Dimensions In Inches	
	Min	Max	Min	Max
A	0.800	1.100	0.031	0.044
A1	0.000	0.100	0.000	0.004
B	1.150	1.350	0.045	0.054
b	0.150	0.400	0.006	0.016
C	1.800	2.450	0.071	0.096
D	1.800	2.250	0.071	0.089
e	1.300		0.051	
H	0.080	0.260	0.003	0.010
L	0.210	0.460	0.008	0.018

SC-70-3 Surface Mount Package

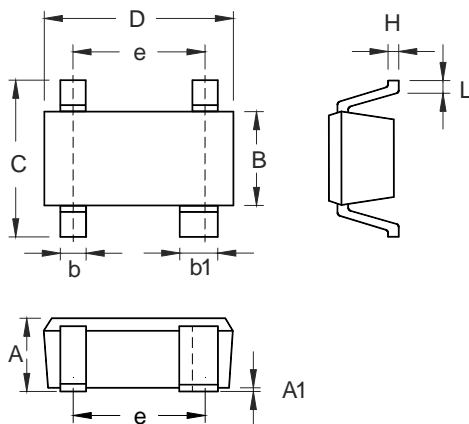

Symbol	Dimensions In Millimeters		Dimensions In Inches	
	Min	Max	Min	Max
A	0.800	1.100	0.031	0.043
A1	0.000	0.100	0.000	0.004
B	1.150	1.350	0.045	0.053
b	0.150	0.400	0.006	0.016
b1	0.350	0.500	0.014	0.020
C	1.800	2.450	0.071	0.096
D	1.800	2.200	0.071	0.087
e	1.300		0.051	
H	0.080	0.260	0.003	0.010
L	0.200	0.460	0.008	0.018

**SC-82 Surface Mount Package**

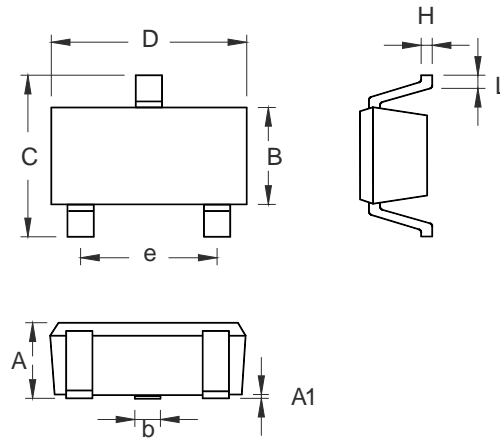

Symbol	Dimensions In Millimeters		Dimensions In Inches	
	Min	Max	Min	Max
A	0.889	1.295	0.035	0.051
A1	0.000	0.152	0.000	0.006
B	1.397	1.803	0.055	0.071
b	0.356	0.508	0.014	0.020
C	2.591	2.997	0.102	0.118
D	2.692	3.099	0.106	0.122
e	1.803	2.007	0.071	0.079
H	0.080	0.254	0.003	0.010
L	0.300	0.610	0.012	0.024

**SOT-23-3 Surface Mount Package**

**Richtek Technology Corporation**

Headquarter  
 5F, No. 20, Taiyuen Street, Chupei City  
 Hsinchu, Taiwan, R.O.C.  
 Tel: (8863)5526789 Fax: (8863)5526611

**Richtek Technology Corporation**

Taipei Office (Marketing)  
 5F, No. 95, Minchiuan Road, Hsintien City  
 Taipei County, Taiwan, R.O.C.  
 Tel: (8862)86672399 Fax: (8862)86672377  
 Email: marketing@richtek.com

Information that is provided by Richtek Technology Corporation is believed to be accurate and reliable. Richtek reserves the right to make any change in circuit design, specification or other related things if necessary without notice at any time. No third party intellectual property infringement of the applications should be guaranteed by users when integrating Richtek products into any application. No legal responsibility for any said applications is assumed by Richtek.