

# DATA SHEET

## **TDA4850**

Horizontal and vertical deflection  
controller for VGA/XGA and  
multi-frequency monitors

Preliminary specification  
File under Integrated Circuits, IC02

September 1991

# Horizontal and vertical deflection controller for VGA/XGA and multi-frequency monitors

## TDA4850

### FEATURES

- VGA operation fully implemented including alignment-free vertical and E/W amplitude presettings
- 4th VGA mode easy applicable (XGA, Super VGA)
- Multi-frequency operation externally selectable
- All adjustments DC-controllable
- Alignment-free oscillators
- Sync separators for video or horizontal and vertical TTL sync levels regardless of polarity
- Horizontal oscillator with PLL1 for sync and PLL2 for flyback
- Constant vertical and E/W amplitude in multi-frequency operation
- DC-coupling to vertical power amplifier (TDA4860, TDA8351)
- Internal supply voltage stabilization with excellent ripple rejection to ensure stable geometrical adjustments

### GENERAL DESCRIPTION

The TDA4850 is a monolithic integrated circuit for economical solutions in VGA/XGA and multi-frequency monitors. The IC incorporates the complete horizontal and vertical small signal processing. VGA-dependent mode detection and settings are performed on chip. In conjunction with TDA4860 or TDA8351 (vertical output circuits) both ICs offer an extremely advanced system solution.

### QUICK REFERENCE DATA

SYMBOL	PARAMETER	MIN.	TYP.	MAX.	UNIT
$V_P$	supply voltage (pin 1)	9.2	12	16	V
$I_P$	supply current	–	40	–	mA
$V_{i\ sync}$	AC-coupled composite video signal with negative-going sync (peak-to-peak value, pin 9)	–	1	–	V
	sync slicing level	–	120	–	mV
	DC-coupled TTL-compatible horizontal sync signal (peak value, pin 9)	1.7	–	–	V
	slicing level	1.2	1.4	1.6	V
$I_{oV}$	DC-coupled TTL-compatible vertical sync signal (peak value, pin 10)	1.7	–	–	V
	slicing level	1.2	1.4	1.6	V
$I_{oV}$	vertical differential output current (peak-to-peak value, pins 5 and 6)	–	1	–	mA
$I_{oH}$	horizontal sink output current on pin 3	–	–	60	mA
$T_{amb}$	operating ambient temperature	0	–	70	°C

### ORDERING INFORMATION

EXTENDED TYPE NUMBER	PACKAGE			
	PINS	PIN POSITION	MATERIAL	CODE
TDA4850	20	DIL	plastic	SOT146 <sup>(1)</sup>

### Note

1. SOT 146-1; 1996 November 15

# Horizontal and vertical deflection controller for VGA/XGA and multi-frequency monitors

TDA4850

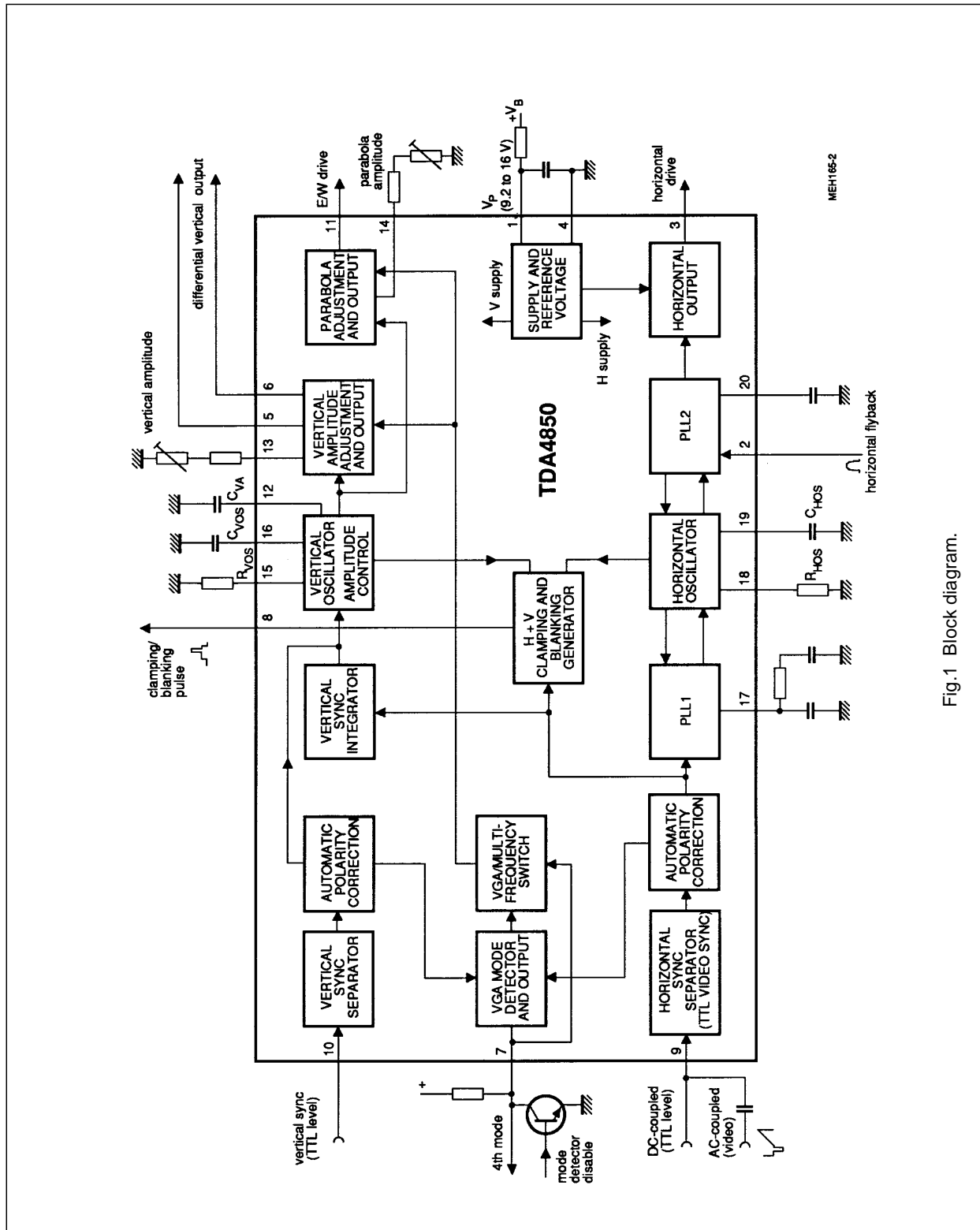

Fig.1 Block diagram.

# Horizontal and vertical deflection controller for VGA/XGA and multi-frequency monitors

TDA4850

## PINNING

SYMBOL	PIN	DESCRIPTION
V <sub>P</sub>	1	positive supply voltage
FLB	2	horizontal flyback input
HOR	3	horizontal output
GND	4	ground (0 V)
VERT1	5	vertical output 1; negative-going sawtooth
VERT2	6	vertical output 2; positive-going sawtooth
MODE	7	4th mode output and mode detector disable input
CLBL	8	clamping/blanking pulse output
HVS	9	horizontal sync /video input
VS	10	vertical sync input
EW	11	E/W output (parabola to driver stage)
C <sub>VA</sub>	12	capacitor for amplitude control
R <sub>VA</sub>	13	vertical amplitude adjustment input
R <sub>EW</sub>	14	E/W amplitude adjustment input (parabola)
R <sub>VOS</sub>	15	vertical oscillator resistor
C <sub>VOS</sub>	16	vertical oscillator capacitor
PLL1	17	PLL1 phase
R <sub>HOS</sub>	18	horizontal oscillator resistor
C <sub>HOS</sub>	19	horizontal oscillator capacitor
PLL2	20	PLL2 phase

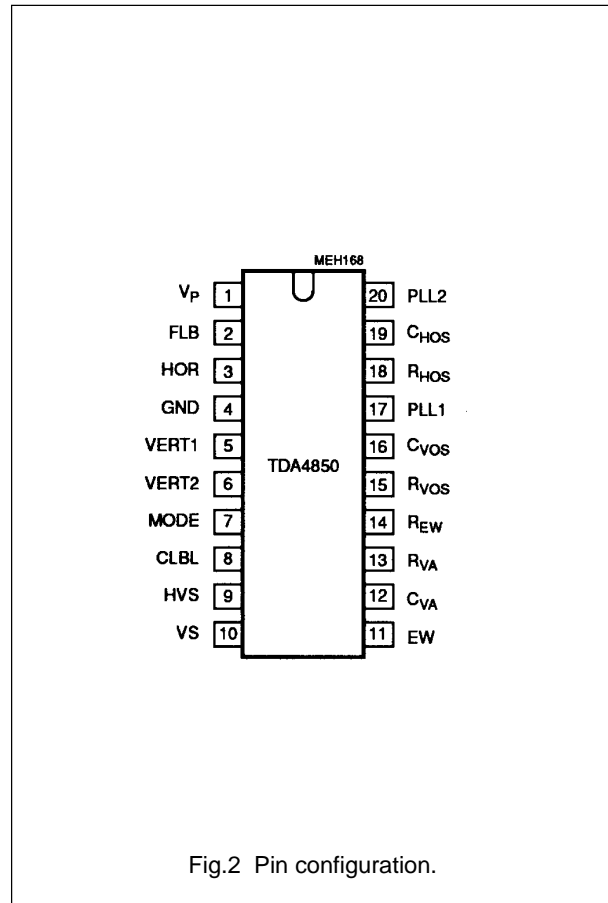

Fig.2 Pin configuration.

## FUNCTIONAL DESCRIPTION

### Horizontal sync separator and polarity correction

An AC-coupled video signal or a DC-coupled TTL sync signal (H only or composite sync) is input on pin 9. Video signals are clamped with top sync on 1.28 V, and are sliced at 1.4 V. This results in a fixed absolute slicing level of 120 mV related to top sync.

DC-coupled TTL sync signals are also sliced at 1.4 V, however with the clamping circuit in current limitation. The polarity of the separated sync is detected by internal integration of the signal, then the polarity is corrected. The polarity information is fed to the VGA mode detector. The corrected sync is input signal for the vertical sync integrator and the PLL1 stage.

### Vertical sync separator, polarity correction and vertical sync integrator

DC-coupled vertical TTL sync signals may be applied to pin 10. They are sliced at 1.4 V. The polarity of the separated sync is detected by internal integration, then polarity is corrected. The polarity information is fed to the VGA mode detector. If pin 10 is not used, it must be connected to ground. The separated  $V_{i\text{ sync}}$  signal from pin 10, or the integrated composite sync signal from pin 9 (TTL or video) triggers directly the vertical oscillator.

## Horizontal and vertical deflection controller for VGA/XGA and multi-frequency

TDA4850

### VGA mode detector and mode output

The three standard VGA modes and a 4th not fixed mode are decoded by the polarities of the horizontal and the vertical sync input signals. An external resistor (from  $V_P$  to pin 7) is necessary to match this function. In all three VGA modes the correct amplitudes are activated. The presence of the 4th mode is indicated by HIGH on pin 7. This signal can be used externally to switch any horizontal or vertical parameters.

### VGA mode detector input

For multi-frequency operation the voltage on pin 7 must be externally forced to a level of <50 mV. Vertical amplitude pre-settings for VGA are then inhibited. The delay time between vertical trigger pulse and the start of vertical deflection changes from 575  $\mu$ s to 300  $\mu$ s (575  $\mu$ s is needed for VGA). The vertical amplitude then remains constant in a frequency range from 50 Hz up to 110 Hz.

### Clamping and blanking generator

A combined clamping and blanking pulse is available on pin 8 (suitable for the video pre-amplifier TDA 4880). The lower level of 2.1 V can be the blanking signal derived from line flyback, or the vertical blanking pulse from the internal vertical oscillator.

Vertical blanking equals to the delay between vertical sync and start of vertical scan. By this, an optimum blanking is achieved for VGA/XGA as well as for multi-frequency operation (selectable via pin 7).

The upper level of 3.9 V is the horizontal clamping pulse with internally fixed pulse width of 1  $\mu$ s. A monoflop, which is triggered by the trailing edge of the horizontal sync pulse, generates this pulse.

### PLL1 phase detector

The phase detector is a standard one using switched current sources. The middle of the sync is compared with a fixed point of the oscillator sawtooth voltage. The PLL filter is connected to pin 17.

### Horizontal oscillator

This oscillator is a relaxation type oscillator. Its frequency is determined mainly by the capacitor on pin 19. A frequency range of one octave is achieved by the current on pin 18. The  $\phi_1$  control voltage from pin 17 is fed via a buffer amplifier and an attenuator to the current reference pin 18 to achieve a high DC loop gain. Therefore, changes in frequency will not affect the phase relationship between horizontal sync pulses and line flyback pulses.

### PLL2 phase detector

This phase detector is similar to the PLL1 phase detector. Line flyback signals (pin 2) are compared with a fixed point of the oscillator sawtooth voltage. Delays in the horizontal deflection circuit are compensated by adjusting the phase relationship between horizontal sync and horizontal output pulses. A certain amount of phase adjustment is possible by injecting a DC current from an external source into the PLL2 filter capacitor on pin 20.

### Horizontal driver

This open-collector output stage (pin 3) can directly drive an external driver transistor. The saturation voltage is 300 mV at 20 mA. To protect the line deflection transistor, the horizontal output stage does not conduct at  $V_P < 6.4$  V (pin 1).

### Vertical oscillator and amplitude control

This stage is designed for fast stabilization of the vertical amplitude after changes in sync conditions. The free-running frequency  $f_o$  is determined by the values of  $R_{VOS}$  and  $C_{VOS}$ . The recommended values should be altered marginally only to preserve the excellent linearity and noise performance. The vertical drive currents  $I_5$  and  $I_6$  are in relation to the value of  $R_{VOS}$ . Therefore, the oscillator frequency must be determined only by  $C_{VOS}$  on pin 16.

$$f_o = 1 / (10.8 \times R_{VOS} \times C_{VOS})$$

To achieve a stabilized amplitude the free-running frequency  $f_o$  (without adjustment) must be lower than the lowest occurring sync frequency. The following contributions can be assumed:

- minimum frequency offset between  $f_o$  and the lowest trigger frequency  $\pm 10\%$
- spread of IC  $\pm 3\%$
- spread of R (22 k $\Omega$ )  $\pm 1\%$
- spread of C (0.1  $\mu$ F)  $\pm 5\%$
- spread of R (22 k $\Omega$ ) 19%
- spread of C (0.1  $\mu$ F)

Result:  $f_o = 50 \text{ Hz} / 1.19 = 42 \text{ Hz}$   
(for 50 to 110 Hz application)

# Horizontal and vertical deflection controller for VGA/XGA and multi-frequency monitors

TDA4850

**Table 1** VGA modes

MODE	H/V SYNC POLARITY	FREQUENCY H	FREQUENCY V	NUMBER OF ACTIVE LINES	MODE OUTPUT PIN 7
1	+/-	31.45 kHz	70 Hz	350	LOW
2	-/+	31.45 kHz	70 Hz	400	LOW
3	-/-	31.45 kHz	60 Hz	480	LOW
4	+/+	fixed by external circuitry	-	-	HIGH

**LIMITING VALUES**

In accordance with the Absolute Maximum System (IEC 134)

SYMBOL	PARAMETER	MIN.	MAX.	UNIT
$V_P$	supply voltage (pin 1)	-0.5	16	V
$V_{3,7}$	voltage on pins 3 and 7	-0.5	16	V
$V_8$	voltage on pin 8	-0.5	7	V
$V_n$	voltage on pins 5, 6, 9, 10, 13, 14 and 18	-0.5	6.5	V
$I_2$	current on pin 2	-	$\pm 10$	mA
$I_3$	current on pin 3	-	100	mA
$I_7$	current on pin 7	-	20	mA
$I_8$	current on pin 8	-	-10	mA
$T_{stg}$	storage temperature range	-55	150	$^{\circ}\text{C}$
$T_{amb}$	operating ambient temperature range	0	70	$^{\circ}\text{C}$
$T_j$	maximum junction temperature	0	150	$^{\circ}\text{C}$
$V_{ESD}$	electrostatic handling <sup>(1)</sup> for all pins	-	$\pm 300$	V

**Note**

- Equivalent to discharging a 200 pF capacitor through a 0  $\Omega$  series resistor.

**THERMAL RESISTANCE**

SYMBOL	PARAMETER	MIN.	MAX.	UNIT
$R_{th\ j-a}$	from junction-to-ambient in free air	-	65	K/W

# Horizontal and vertical deflection controller for VGA/XGA and multi-frequency monitors

TDA4850

**CHARACTERISTICS**

$V_P = 12\text{ V}$ ;  $T_{\text{amb}} = 25\text{ °C}$  and measurements taken in Fig.3 unless otherwise specified

SYMBOL	PARAMETER	CONDITIONS	MIN.	TYP.	MAX.	UNIT
$V_P$	supply voltage range (pin 1)		9.2	12	16	V
$I_P$	supply current		–	40	–	mA
<b>Internal reference voltage</b>						
$V_{\text{ref}}$	internal reference voltage		6.0	6.25	6.5	V
TC	temperature coefficient	$T_{\text{amb}} = 20\text{ to }100\text{ °C}$	–	–	$\pm 90$	$10^{-6}/\text{K}$
PSRR	power supply ripple rejection	$f = 1\text{ kHz}$ sinewave	60	75	–	dB
		$f = 1\text{ MHz}$ sinewave	25	35	–	dB
$V_P$	supply voltage (pin 1) to ensure all internal reference voltages		9.2	–	16	V
<b>Composite sync input (AC-coupled)</b>			$V_{10} = 5\text{ V}$			
$V_{i\text{ sync}}$	sync amplitude of video input signal (pin 9)	sync on green	–	300	–	mV
	top sync clamping level		1.1	1.28	1.5	V
	slicing level above top sync level	$R_S = 50\ \Omega$	90	120	150	mV
$R_S$	allowed source resistance for 7% duty-cycle	$V_{i\text{ sync}} > 200\text{ mV}$	–	–	1.5	$\text{k}\Omega$
$r_g$	differential input resistance	during sync	–	80	–	$\Omega$
$I_g$	charging current of coupling capacitor	$V_g > 1.5\text{ V}$	1.3	2	3	$\mu\text{A}$
$t_{\text{int}}$	vertical sync integration time to generate sync pulse		7	10	13	$\mu\text{s}$
<b>Horizontal sync input (DC-coupled, TTL-compatible)</b>						
$V_{i\text{ sync}}$	sync input signal (peak value, pin 9) slicing level		1.7	–	–	V
			1.2	1.4	1.6	V
$t_p$	minimum pulse width		700	–	–	ns
$t_r, t_f$	rise time and fall time		10	–	500	ns
$I_g$	input current	$V_g = 0.8\text{ V}$	–	–	–200	$\mu\text{A}$
		$V_g = 5.5\text{ V}$	–	–	10	$\mu\text{A}$
<b>Automatic horizontal polarity switch</b>			H-sync on pin 9			
$t_p\text{ H}/t_H$	horizontal sync pulse width related to $t_H$ (duty cycle for automatic polarity correction)		–	–	30	%
$t_p$	delay time for changing sync polarity		0.3	–	1.8	ms
<b>Vertical sync input (DC-coupled, TTL-compatible)</b>			V-sync on pin 10			
$V_{i\text{ sync}}$	sync input signal (peak value, pin 10) slicing level		1.7	–	–	V
			1.2	1.4	1.6	V
$I_{10}$	input current	$0 < V_{10} < 5.5\text{ V}$	–	–	10	$\mu\text{A}$
$t_p\text{ V}$	maximum vertical sync pulse width for automatic vertical polarity switch		–	–	300	$\mu\text{s}$

# Horizontal and vertical deflection controller for VGA/XGA and multi-frequency monitors

TDA4850

SYMBOL	PARAMETER	CONDITIONS	MIN.	TYP.	MAX.	UNIT
<b>Horizontal mode detector output</b>		VGA mode				
V <sub>7</sub>	output saturation voltage LOW (for modes 1, 2 and 3)	I <sub>7</sub> = 6 mA	–	0.275	0.33	V
	output voltage HIGH	mode 4	–	–	V <sub>P</sub>	V
I <sub>7</sub>	load current range to force VGA mode-dependent vertical and parabola amplitudes	modes 1, 2 and 3	2	–	6	mA
	output current	mode 4	–	0	–	mA
<b>VGA / multi-frequency mode switch</b>						
V <sub>7</sub>	input voltage LOW to force multi-frequency mode		0	–	50	mV
<b>Horizontal comparator PLL1</b>						
V <sub>17</sub>	upper control voltage limitation		–	5.0	–	V
	lower control voltage limitation		–	1.2	–	V
I <sub>17</sub>	control current	Fig.4	–	±300	–	µA
<b>Horizontal oscillator</b>						
f <sub>osc</sub>	centre frequency	R <sub>18</sub> = 12 kΩ (pin 18); C <sub>19</sub> = 2.2 nF (pin 19)	–	31.45	–	kHz
	deviation of centre frequency		–	–	±3	%
	temperature coefficient		–	–	±150	10 <sup>-6</sup> /K
φ <sub>H</sub> /t <sub>H</sub>	relative holding/catching range		±6	±6.5	±7.3	%
R <sub>18</sub>	external oscillator resistor		9	–	18	kΩ
V <sub>18</sub>	voltage at reference current input (pin 18)	PLL1 and PLL2 locked; V <sub>ref</sub> = 6.25 V	–	3.125	–	V
ΔV <sub>18</sub>	control voltage range		–	±205	–	mV
<b>Horizontal PLL2</b>		Fig.4				
V <sub>2</sub>	upper clamping level of flyback input	I <sub>2</sub> = 6 mA	–	5.5	–	V
	lower clamping level of flyback input	I <sub>2</sub> = –1 mA	–	–0.75	–	V
	H-flyback slicing level		–	3.0	–	V
I <sub>2</sub>	input current	H-scan; V <sub>8</sub> < 0.9 V	–0.5	–	–	mA
		H-flyback; V <sub>8</sub> > 1.8 V	–	–	–0.2	mA
t <sub>d</sub> /t <sub>H</sub>	delay between middle of sync and middle of H-flyback related to t <sub>H</sub>		–	3.0	–	%
V <sub>20</sub>	upper control voltage limitation		–	4.6	–	V
	lower control voltage limitation		–	1.6	–	V
I <sub>20</sub>	control current		–	±200	–	µA
Δt/t <sub>H</sub>	PLL2 control range related to t <sub>H</sub>		30%	–	–	%



# Horizontal and vertical deflection controller for VGA/XGA and multi-frequency monitors

TDA4850

SYMBOL	PARAMETER	CONDITIONS	MIN.	TYP.	MAX.	UNIT
<b>Horizontal output (open-collector)</b>		Fig.4				
V <sub>3</sub>	output voltage LOW	I <sub>3</sub> = 20 mA	–	–	0.3	V
		I <sub>3</sub> = 60 mA	–	–	0.8	V
t <sub>p</sub> /t <sub>H</sub>	t <sub>H</sub> duty cycle		42	45	48	%
V <sub>P</sub>	threshold to activate too low supply voltage protection	horizontal output off	–	5.8	–	V
		horizontal output on	–	6.4	–	V
<b>Horizontal clamping/blanking generator output</b>		Fig.4				
V <sub>8</sub>	output voltage LOW	H and V scanning	–	–	0.9	V
	blanking output voltage	internal V blanking	1.8	2.1	2.4	V
		external H blanking	1.8	2.1	2.4	V
	clamping output voltage	H-sync on pin 9	3.5	3.9	4.3	V
I <sub>8</sub>	internal sink current for all output levels	H and V scanning	2.3	2.9	3.5	mA
t <sub>8</sub>	clamping pulse start		with end of H-sync			
t <sub>clp</sub>	clamping pulse width		0.8	1.0	1.2	μs
S	steepness of rise and fall times		–	40	–	ns/V
<b>Vertical oscillator</b>		V <sub>ref</sub> = 6.25 V				
f <sub>o</sub>	vertical free-running frequency	R <sub>15</sub> = 22 kΩ; C <sub>16</sub> = 0.1 μF		42	–	Hz
f <sub>V</sub>	nominal vertical sync range	no f <sub>o</sub> adjustment	50	–	110	Hz
V <sub>15</sub>	voltage on pin 15	R <sub>15</sub> = 22 kΩ	2.8	3.0	3.2	V
t <sub>d</sub>	delay between sync pulse and start of vertical scan in VGA/XGA mode, activated by an external resistor on pin 7 in multi-frequency mode	measured on pin 8				
			500	575	650	μs
		V <sub>7</sub> < 50 mV	240	300	360	μs
I <sub>12</sub>	control current for amplitude control		–	±200	–	μA
C <sub>12</sub>	capacitor for amplitude control		–	–	0.33	μF
<b>Vertical differential output</b>		Fig.5				
I <sub>o</sub>	differential output current between pins 5 and 6 (peak-to-peak value)	mode 3; I <sub>13</sub> > –135 μA; R <sub>15</sub> = 22 kΩ	0.9	1.0	1.1	mA
	maximum offset-current error	I <sub>o</sub> = 1 mA	–	–	±2.5	%
	maximum linearity error		–	–	±1.5	%

# Horizontal and vertical deflection controller for VGA/XGA and multi-frequency monitors

TDA4850

SYMBOL	PARAMETER	CONDITIONS	MIN.	TYP.	MAX.	UNIT
<b>Vertical amplitude adjustment</b> (in percents of output signal)						
V <sub>13</sub>	input voltage		–	5.0	–	V
I <sub>13</sub>	adjustment current	I <sub>o max</sub> (100%) I <sub>o min</sub> (typically 58%)	–110 –	–120 0	–135 –	μA μA
ΔI <sub>o</sub> /Δt	VGA mode-dependent pre-settings activated by an external resistor on pin 7 in mode 1 in mode 2 in mode 3 in mode 4 in multi-frequency operation (VGA operation disabled)	Table 1; note 1     V <sub>7</sub> < 50 mV	116.1 102.0 – – –	116.8 102.2 100 100 100	117.5 102.5 – – –	% % % % %
<b>E/W output</b>			note 2			
V <sub>11</sub>	bottom output signal during mid-scan (pin 11) top output signal during flyback temperature coefficient of output signal	internally stabilized	1.05 4.2 –	1.2 4.5 –	1.35 4.8 250	V V 10 <sup>-6</sup> /K
<b>E/W amplitude adjustment (parabola)</b>			Fig.5			
V <sub>14</sub>	input voltage (pin 14)		–	5.0	–	V
I <sub>14</sub>	adjustment current	100% parabola typically 28% parabola	–110 –	–120 0	–135 –	μA μA

**Notes**

1. ΔI<sub>o</sub>/Δt relative to value of mode 3.
2. Parabola amplitude tracks with mode-dependent vertical amplitude but not with vertical amplitude adjustment. Tracking can be achieved by a resistor from vertical amplitude potmeter to pin 14.

Horizontal and vertical deflection controller for  
VGA/XGA and multi-frequency monitors

TDA4850

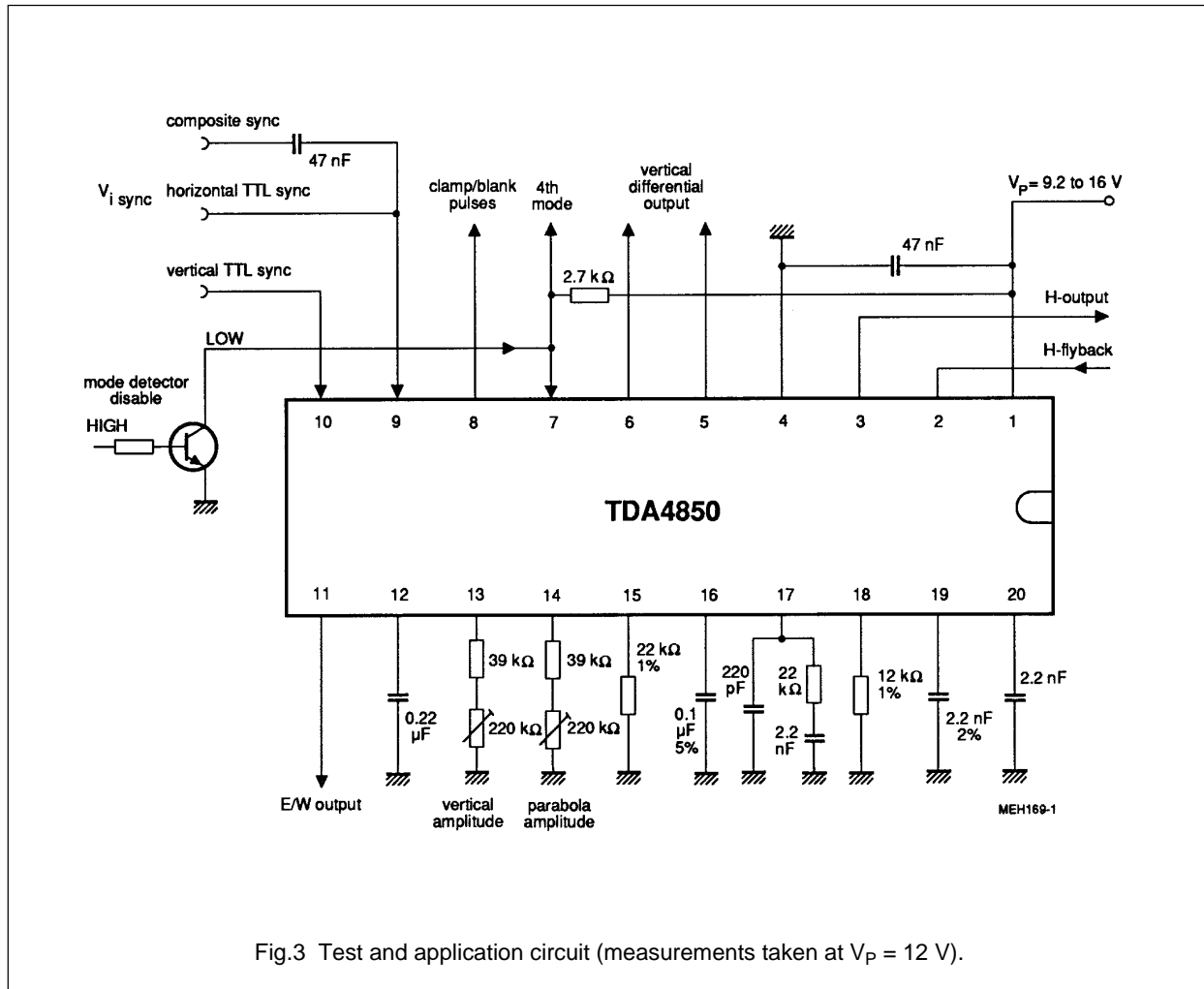

Fig.3 Test and application circuit (measurements taken at  $V_p = 12$  V).

Horizontal and vertical deflection controller for  
VGA/XGA and multi-frequency monitors

TDA4850

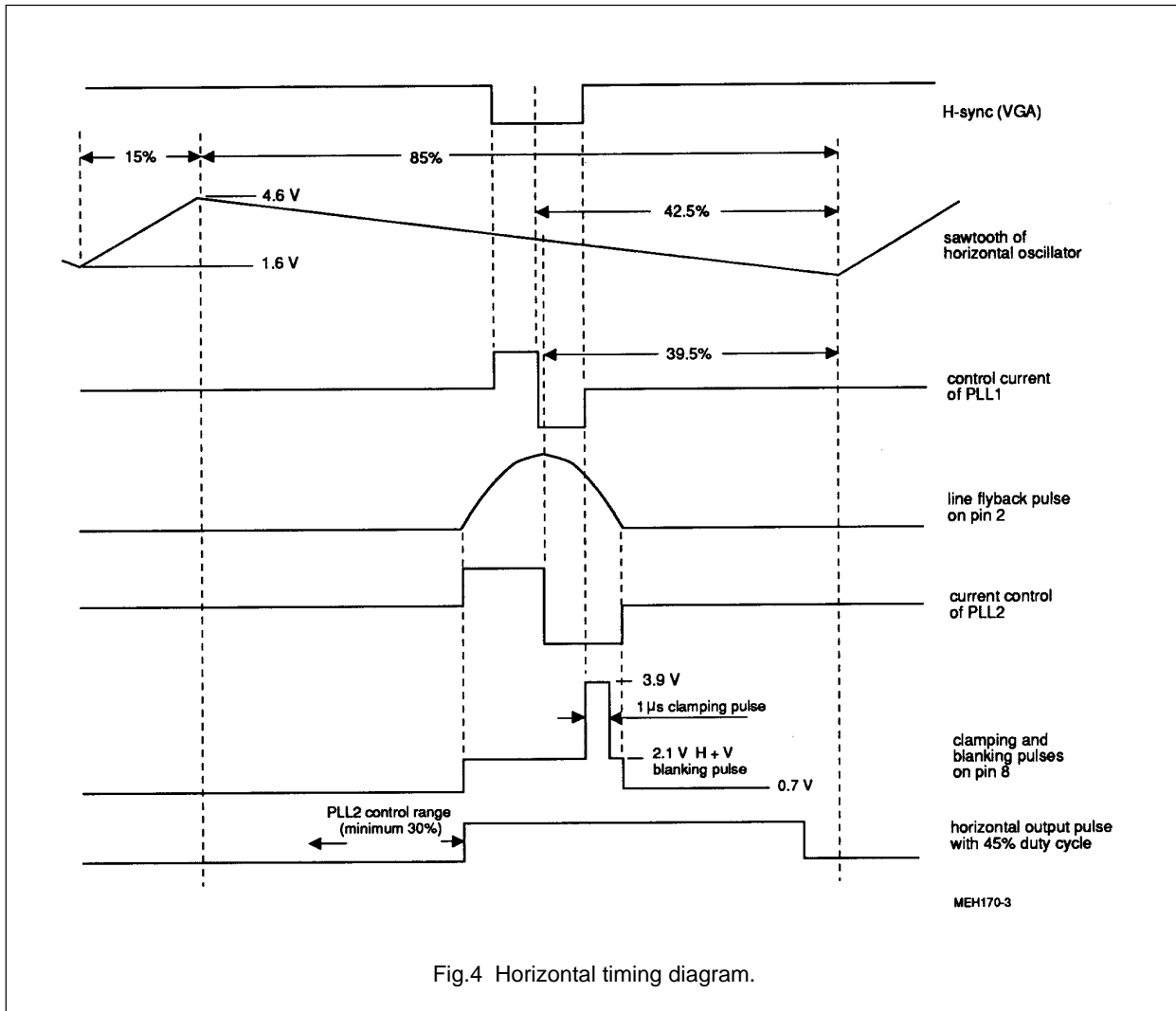

Fig.4 Horizontal timing diagram.

Horizontal and vertical deflection controller for  
VGA/XGA and multi-frequency monitors

TDA4850

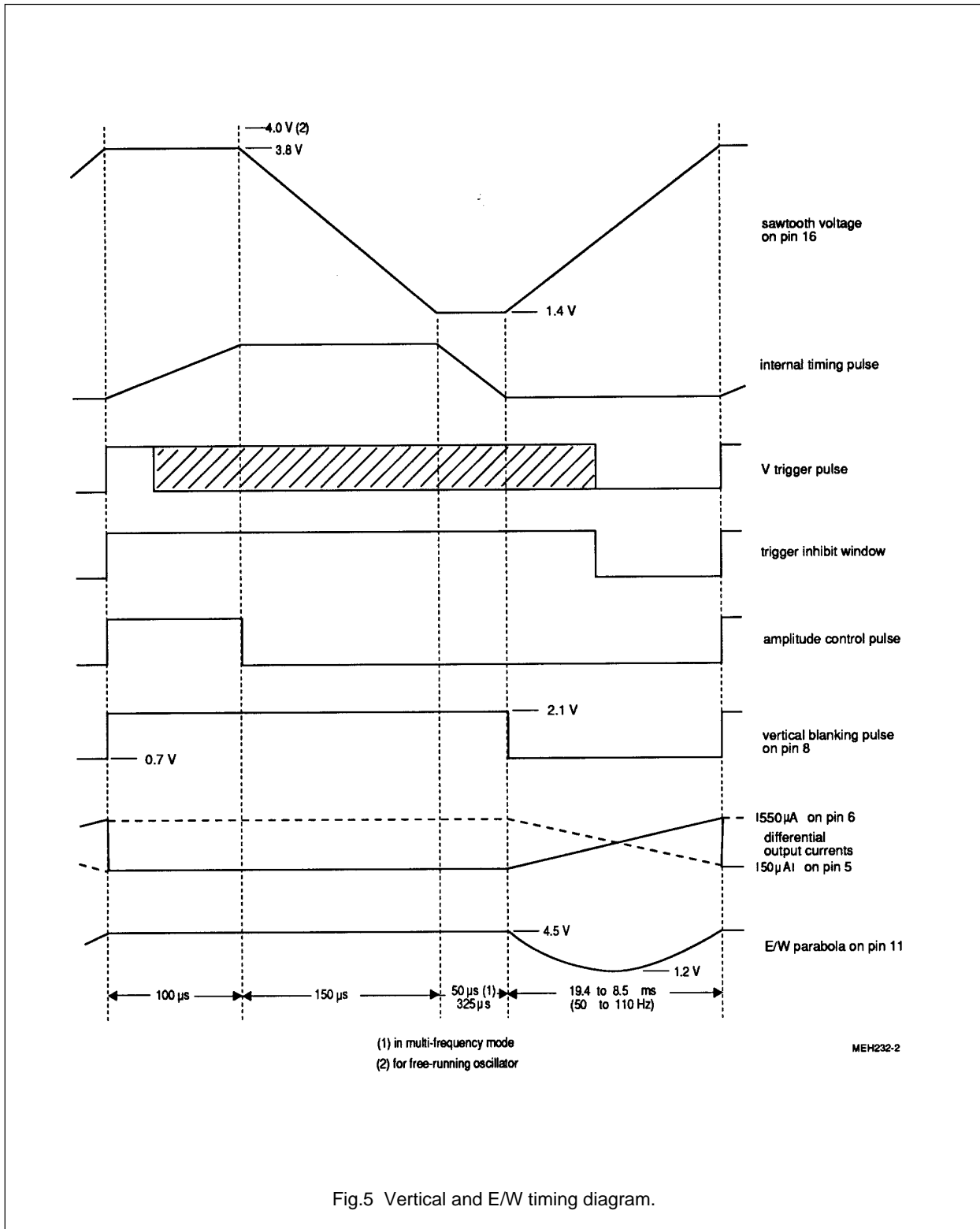

Fig.5 Vertical and E/W timing diagram.

Horizontal and vertical deflection controller for  
VGA/XGA and multi-frequency monitors

TDA4850

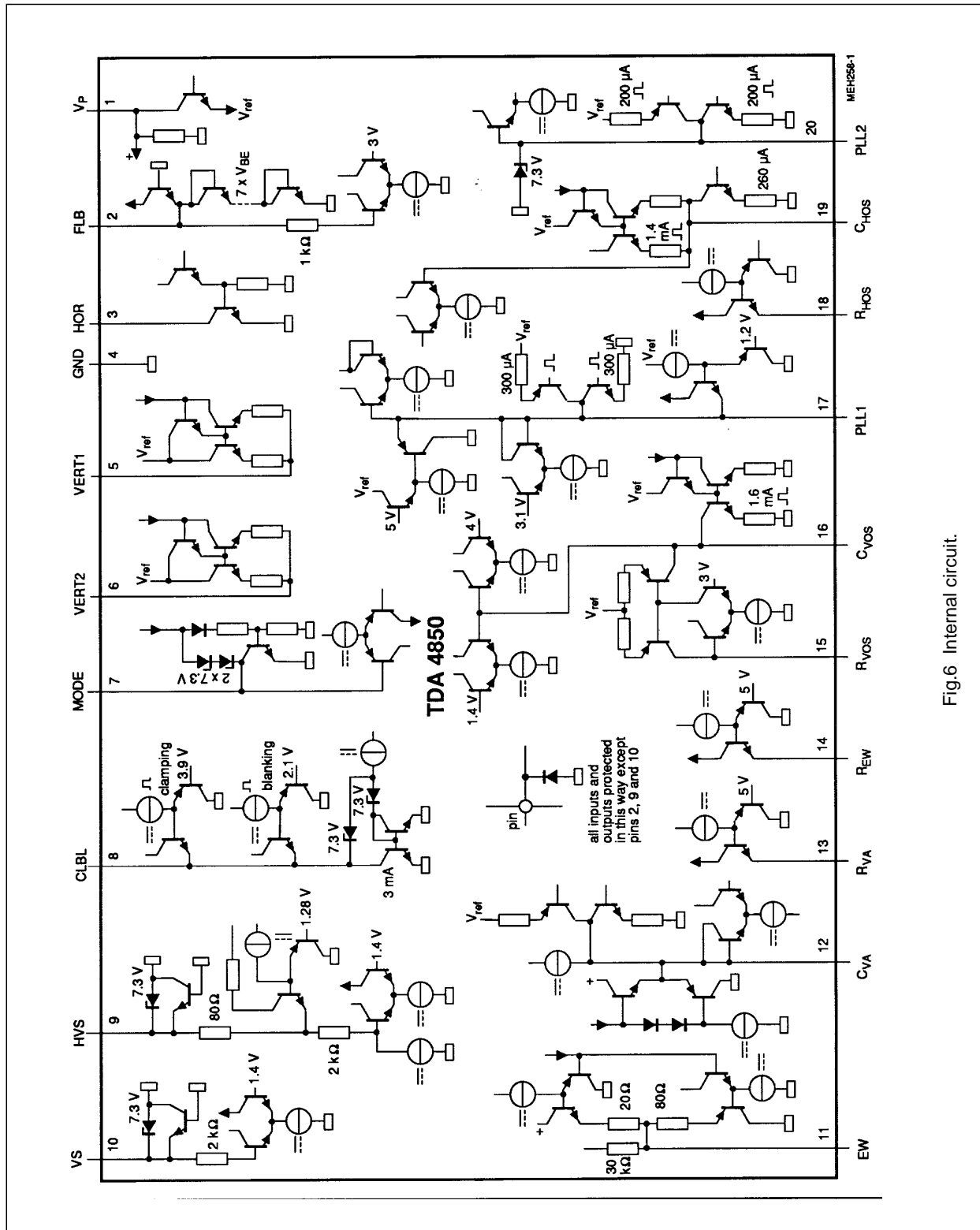

Fig.6 Internal circuit.

# Horizontal and vertical deflection controller for VGA/XGA and multi-frequency monitors

TDA4850

## PACKAGE OUTLINE

DIP20: plastic dual in-line package; 20 leads (300 mil)

SOT146-1

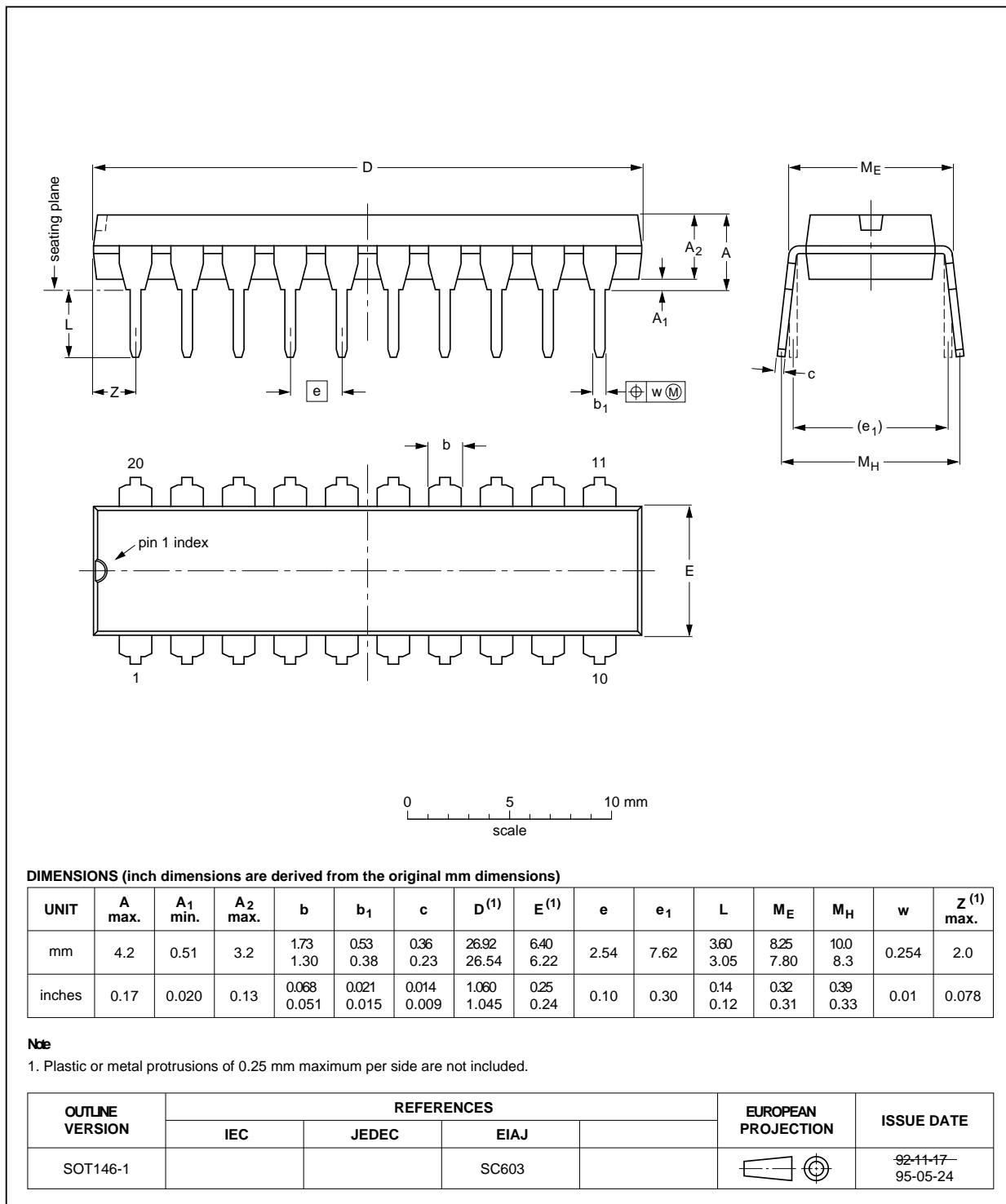

# Horizontal and vertical deflection controller for VGA/XGA and multi-frequency monitors

TDA4850

## SOLDERING

### Introduction

There is no soldering method that is ideal for all IC packages. Wave soldering is often preferred when through-hole and surface mounted components are mixed on one printed-circuit board. However, wave soldering is not always suitable for surface mounted ICs, or for printed-circuits with high population densities. In these situations reflow soldering is often used.

This text gives a very brief insight to a complex technology. A more in-depth account of soldering ICs can be found in our "IC Package Databook" (order code 9398 652 90011).

### Soldering by dipping or by wave

The maximum permissible temperature of the solder is 260 °C; solder at this temperature must not be in contact with the joint for more than 5 seconds. The total contact time of successive solder waves must not exceed 5 seconds.

The device may be mounted up to the seating plane, but the temperature of the plastic body must not exceed the specified maximum storage temperature ( $T_{stg\ max}$ ). If the printed-circuit board has been pre-heated, forced cooling may be necessary immediately after soldering to keep the temperature within the permissible limit.

### Repairing soldered joints

Apply a low voltage soldering iron (less than 24 V) to the lead(s) of the package, below the seating plane or not more than 2 mm above it. If the temperature of the soldering iron bit is less than 300 °C it may remain in contact for up to 10 seconds. If the bit temperature is between 300 and 400 °C, contact may be up to 5 seconds.

## DEFINITIONS

Data sheet status	
Objective specification	This data sheet contains target or goal specifications for product development.
Preliminary specification	This data sheet contains preliminary data; supplementary data may be published later.
Product specification	This data sheet contains final product specifications.
Limiting values	
Limiting values given are in accordance with the Absolute Maximum Rating System (IEC 134). Stress above one or more of the limiting values may cause permanent damage to the device. These are stress ratings only and operation of the device at these or at any other conditions above those given in the Characteristics sections of the specification is not implied. Exposure to limiting values for extended periods may affect device reliability.	
Application information	
Where application information is given, it is advisory and does not form part of the specification.	

## LIFE SUPPORT APPLICATIONS

These products are not designed for use in life support appliances, devices, or systems where malfunction of these products can reasonably be expected to result in personal injury. Philips customers using or selling these products for use in such applications do so at their own risk and agree to fully indemnify Philips for any damages resulting from such improper use or sale.