

200-MHz CMOS OPERATIONAL AMPLIFIER

Check for Samples: [OPA2356-Q1](#)

FEATURES

- Qualified for Automotive Applications
- AEC-Q100 Test Guidance With the Following Results:
 - Device Temperature Grade 1: -40°C to 125°C Ambient Operating Temperature Range
 - Device HBM ESD Classification Level H2
 - Device CDM ESD Classification Level C3B
- Unity-Gain Bandwidth: 450 MHz
- Wide Bandwidth: 200 MHz GBW
- High Slew Rate: 360 V/s
- Low Noise: 5.8 nV/ $\sqrt{\text{Hz}}$
- Excellent Video Performance
 - Differential Gain: 0.02%
 - Differential Phase: 0.05°
 - 0.1-dB Gain Flatness: 75 MHz
- Input Range Includes Ground

- Rail-To-Rail Output (Within 100 mV)
- Low Input Bias Current: 3 pA
- Thermal Shutdown
- Single-Supply Operating Range: 2.5 V to 5.5 V

APPLICATIONS

- Video Processing
- Ultrasound
- Optical Networking, Tunable Lasers
- Photodiode Transimpedance Amplifiers
- Active Filters
- High-Speed Integrators
- Analog-To-Digital (A/D) Converter Input Buffers
- Digital-To-Analog (D/A) Converter Output Amplifiers
- Barcode Scanners
- Communications

DESCRIPTION

The OPA2356-Q1 is a high-speed voltage-feedback CMOS operational amplifier designed for video and other applications requiring wide bandwidth. The OPA2356-Q1 is unity gain stable and can drive large output currents. Differential gain is 0.02% and differential phase is 0.05° . Quiescent current is only 8.3 mA.

OPA2356-Q1 is optimized for operation on single or dual supplies as low as 2.5 V (± 1.25 V) and up to 5.5 V (± 2.75 V). Common-mode input range for the OPA2356-Q1 extends 100 mV below ground and up to 1.5 V from $V+$. The output swing is within 100 mV of the rails, supporting wide dynamic range.

The OPA2356-Q1 is available in the VSSOP-8 package and is specified over the -40°C to 125°C range.

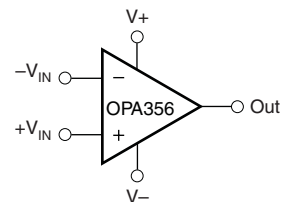
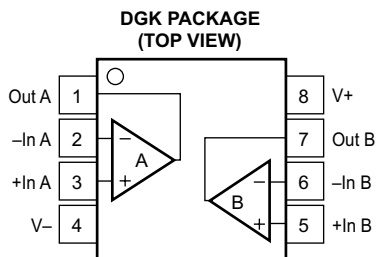

Please be aware that an important notice concerning availability, standard warranty, and use in critical applications of Texas Instruments semiconductor products and disclaimers thereto appears at the end of this data sheet.

PRODUCTION DATA information is current as of publication date. Products conform to specifications per the terms of the Texas Instruments standard warranty. Production processing does not necessarily include testing of all parameters.

Copyright © 2012, Texas Instruments Incorporated

Table 1. ORDERING INFORMATION⁽¹⁾⁽²⁾

T_A	ORDERABLE PART NUMBER	TOP-SIDE MARKING
–40°C to 125°C	OPA2356AQDGKRQ1	AYIZ

- (1) For the most current package and ordering information, see the Package Option Addendum at the end of this document, or see the TI web site at www.ti.com.
- (2) Package drawings, thermal data, and symbolization are available at www.ti.com/packaging.



This integrated circuit can be damaged by ESD. Texas Instruments recommends that all integrated circuits be handled with appropriate precautions. Failure to observe proper handling and installation procedures can cause damage.

ESD damage can range from subtle performance degradation to complete device failure. Precision integrated circuits may be more susceptible to damage because very small parametric changes could cause the device not to meet its published specifications.

ABSOLUTE MAXIMUM RATINGS⁽¹⁾

over operating free-air temperature range (unless otherwise noted)

PARAMETER	VALUE		UNIT
	MIN	MAX	
V_S Supply voltage, V+ to V–		7.5	V
V_{IN} Signal input terminals voltage range ⁽²⁾	–0.5	(V+ + 0.5)	V
V– current ⁽²⁾		10	mA
Output short-circuit duration ⁽³⁾	Continuous		
θ_{JA} Thermal impedance, junction to free air ⁽⁴⁾		150	°C/W
T_A Operating free-air temperature range	–40	125	°C
T_{STG} Storage temperature range	–65	150	°C
T_J Junction temperature		160	°C
T_{LEAD} Lead temperature (soldering, 10 s)		300	°C
ESD Human-body model (HBM) AEC-Q100 Classification Level H2		2	kV
Ratings Charged-device model (CDM) AEC-Q100 Classification Level C3B		750	V

- (1) Stresses above these ratings may cause permanent damage. Exposure to absolute maximum conditions for extended periods may degrade device reliability. These are stress ratings only, and functional operation of the device at these or any other conditions beyond those specified is not implied.
- (2) Input terminals are diode-clamped to the power-supply rails. Input signals that can swing more than 0.5 V beyond the supply rails should be current limited to 10 mA or less.
- (3) Short-circuit to ground one amplifier per package.
- (4) The package thermal impedance is calculated in accordance with JESD 51-5.

RECOMMENDED OPERATING CONDITIONS

	MIN	MAX	UNIT
V_S Supply voltage, V– to V+	2.7	5.5	V
T_A Operating free-air temperature	–40	125	°C

ELECTRICAL CHARACTERISTICS
 $V_S = 2.7\text{ V to }5.5\text{ V}$, $R_F = 604\ \Omega$, $R_L = 150\ \Omega$ connected to $V_S / 2$ (unless otherwise noted)

PARAMETER		TEST CONDITIONS	T_A ⁽¹⁾	MIN	TYP	MAX	UNIT
V_{OS}	Input offset voltage	$V_S = 5\text{ V}$, $V_{CM} = V^- + 0.8\text{ V}$	25°C		±2	±9	mV
			Full range			±15	
$\Delta V_{OS} / \Delta T$	Offset voltage drift over temperature		Full range		±7		µV/°C
PSRR	Offset voltage drift vs power supply	$V_S = 2.7\text{ V to }5.5\text{ V}$, $V_{CM} = V_S / 2 - 0.15\text{ V}$	25°C		±80	±350	µV/V
I_B	Input bias current		25°C		3	±50	pA
I_{OS}	Input offset current		25°C		±1	±50	pA
V_n	Input voltage noise density	$f = 1\text{ MHz}$	25°C		5.8		nV/√Hz
I_n	Input current noise density	$f = 1\text{ MHz}$	25°C		50		fA/√Hz
V_{CM}	Input common-mode voltage range		25°C	$V^- - 0.1$		$V^+ - 1.5$	V
CMRR	Input common-mode rejection ratio	$V_S = 5.5\text{ V}$, $-0.1\text{ V} < V_{CM} < 4\text{ V}$	25°C	66	80		dB
			Full range	66			
Z_{ID}	Differential input impedance		25°C		$10^{13} \parallel 1.5$		Ω pF
Z_{ICM}	Common-mode input impedance		25°C		$10^{13} \parallel 1.5$		Ω pF
A_{OL}	Open-loop gain	OPA356: $V_S = 5\text{ V}$, $0.3\text{ V} < V_O < 4.7\text{ V}$ OPA2356: $V_S = 5\text{ V}$, $0.4\text{ V} < V_O < 4.6\text{ V}$	25°C	84	92		dB
			Full range	80			
			Full range	80			
f_{-3dB}	Small-signal bandwidth	$G = 1$, $V_O = 100\text{ mVp-p}$, $R_F = 0\ \Omega$ $G = 2$, $V_O = 100\text{ mVp-p}$, $R_L = 50\ \Omega$ $G = 2$, $V_O = 100\text{ mVp-p}$, $R_L = 150\ \Omega$ $G = 2$, $V_O = 100\text{ mVp-p}$, $R_L = 1\text{ k}\Omega$	25°C		450		MHz
					100		
					170		
					200		
GBW	Gain-bandwidth product	$G = 10$, $R_L = 1\text{ k}\Omega$	25°C		200		MHz
$f_{0.1dB}$	Bandwidth for 0.1-dB gain flatness	$G = 2$, $V_O = 100\text{ mVp-p}$, $R_F = 560\ \Omega$	25°C		75		MHz
SR	Slew rate	$V_S = 5\text{ V}$, $G = 2$, 4-V output step	25°C		300 –360		V/µs
t_{rf}	Rise-and-fall time	$G = 2$, $V_O = 200\text{ mVp-p}$, 10% to 90% $G = 2$, $V_O = 2\text{ Vp-p}$, 10% to 90%	25°C		2.4		ns
					8		
t_{settle}	Settling time	$V_S = 5\text{ V}$, $G = 2$, 2-V output step	25°C	0.1%	30		ns
				0.01%	120		
Overload recovery time		$V_{IN} \times \text{Gain} = V_S$	25°C		8		ns
Harmonic distortion	Second harmonic	$G = 2$, $f = 1\text{ MHz}$, $V_O = 2\text{ Vp-p}$, $R_L = 200\ \Omega$	25°C		–81		dBc
	Third harmonic		25°C		–93		
Differential gain error		NTSC, $R_L = 150\ \Omega$	25°C		0.02		%
Differential phase error		NTSC, $R_L = 150\ \Omega$	25°C		0.05		°
Voltage output swing from rail		$V_S = 5\text{ V}$, $R_L = 150\ \Omega$, $A_{OL} > 84\text{ dB}$ $V_S = 5\text{ V}$, $R_L = 1\text{ k}\Omega$ $V_S = 5\text{ V}$, $R_L = 50\ \Omega$	25°C		0.2	0.3	V
					0.1		
					0.4	0.6	

(1) Full range $T_A = -40^\circ\text{C to }125^\circ\text{C}$

ELECTRICAL CHARACTERISTICS (continued)
 $V_S = 2.7\text{ V to }5.5\text{ V}$, $R_F = 604\ \Omega$, $R_L = 150\ \Omega$ connected to $V_S / 2$ (unless otherwise noted)

PARAMETER		TEST CONDITIONS	T_A ⁽¹⁾	MIN	TYP	MAX	UNIT
I_O	Output current ⁽²⁾	Continuous	25°C	±60			mA
		Peak		$V_S = 5\text{ V}$	±100		
	$V_S = 3\text{ V}$			±80			
Short-circuit current			25°C	250 -200			mA
Closed-loop output impedance			25°C	0.02			Ω
I_Q	Quiescent current	$V_S = 5\text{ V}$, $I_O = 0$	25°C	8.3 11			mA
			Full range	14			
Thermal shutdown junction temperature		Shutdown	25°C	160			°C
		Reset from shutdown		140			

(2) See typical characteristic graph *Output Voltage Swing vs Output Current*.

TYPICAL CHARACTERISTICS

$T_A = 25^\circ\text{C}$, $V_S = 5\text{ V}$, $G = 2$, $R_F = 604\ \Omega$, $R_L = 150\ \Omega$ connected to $V_S / 2$ (unless otherwise noted)

NON-INVERTING SMALL-SIGNAL
FREQUENCY RESPONSE

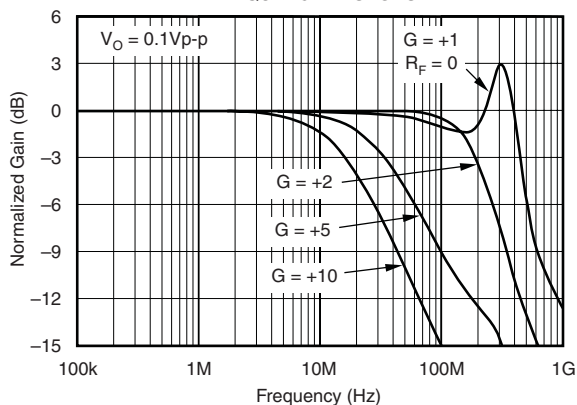

INVERTING SMALL-SIGNAL
FREQUENCY RESPONSE

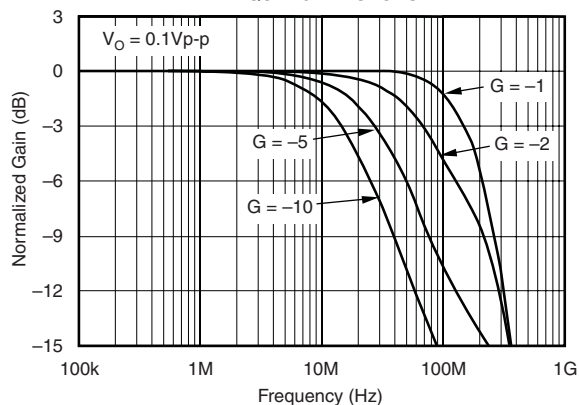

NON-INVERTING SMALL-SIGNAL
STEP RESPONSE

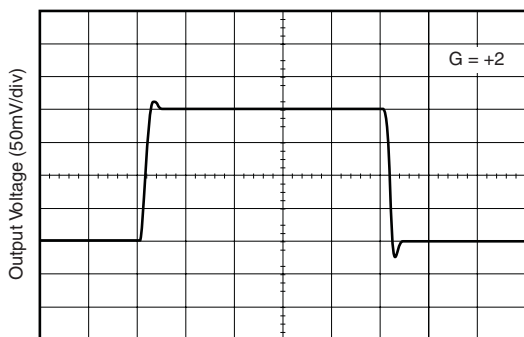

NON-INVERTING LARGE-SIGNAL
STEP RESPONSE

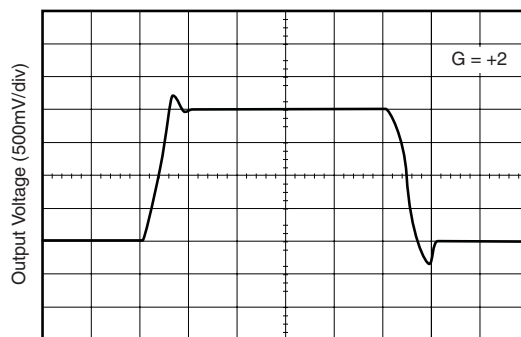

0.1dB GAIN FLATNESS FOR VARIOUS R_F

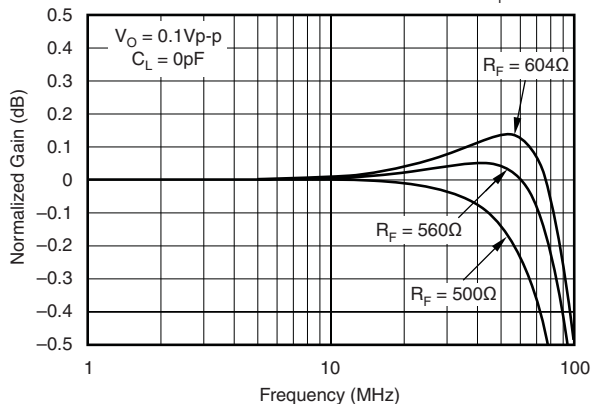

HARMONIC DISTORTION vs OUTPUT VOLTAGE

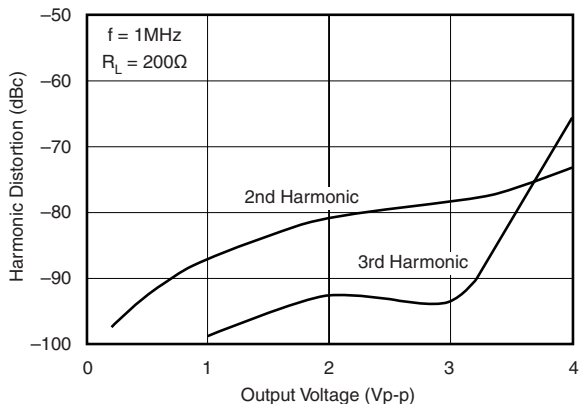

TYPICAL CHARACTERISTICS (continued)

$T_A = 25^\circ\text{C}$, $V_S = 5\text{ V}$, $G = 2$, $R_F = 604\ \Omega$, $R_L = 150\ \Omega$ connected to $V_S / 2$ (unless otherwise noted)

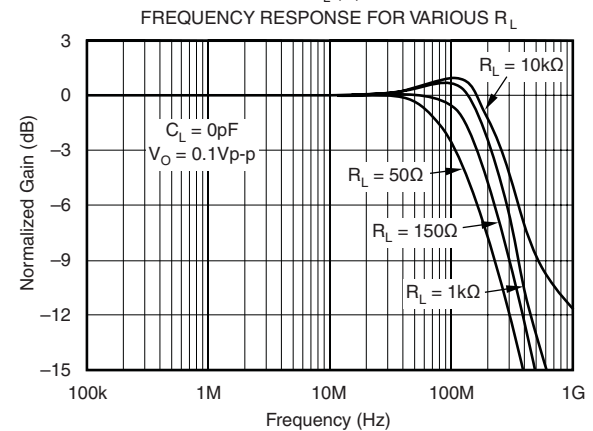
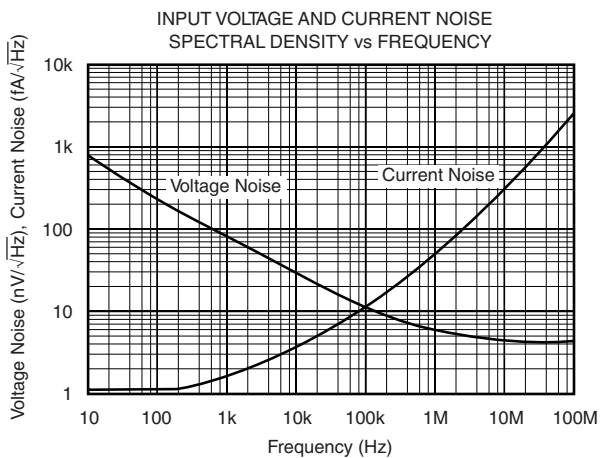
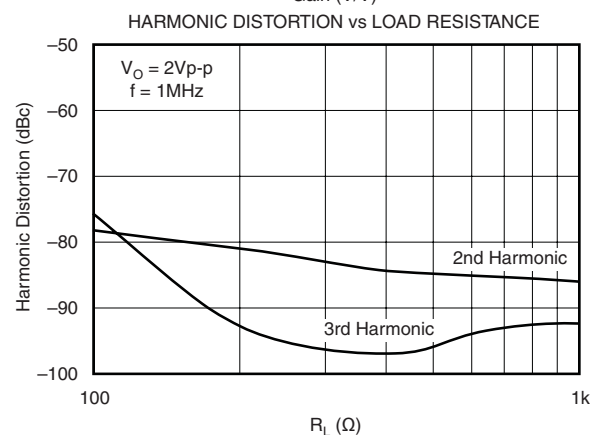
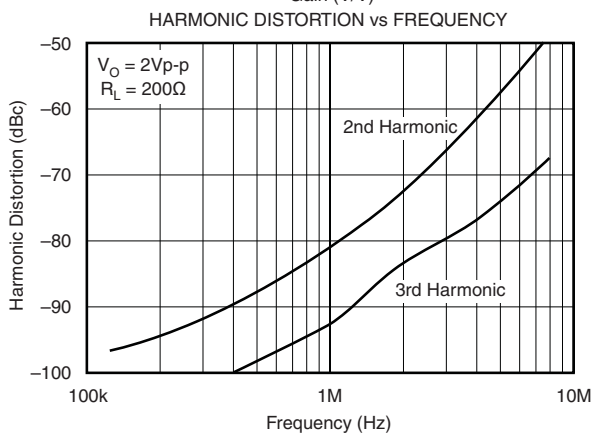
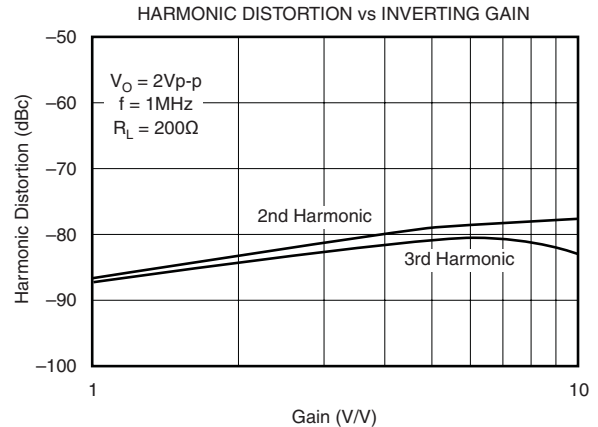
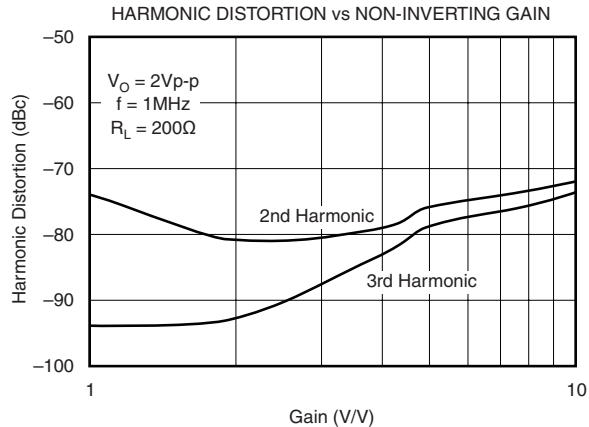

TYPICAL CHARACTERISTICS (continued)

$T_A = 25^\circ\text{C}$, $V_S = 5\text{ V}$, $G = 2$, $R_F = 604\ \Omega$, $R_L = 150\ \Omega$ connected to $V_S / 2$ (unless otherwise noted)

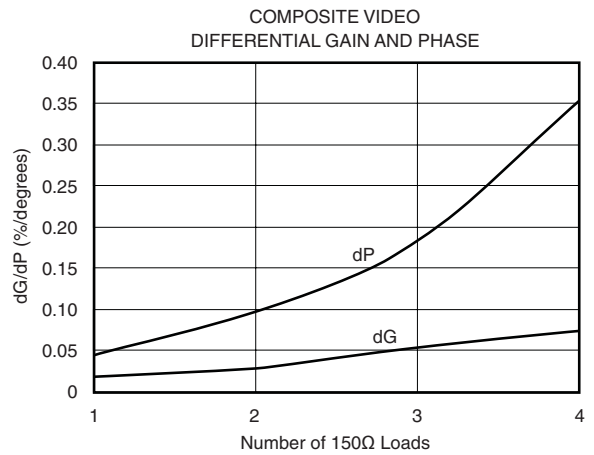
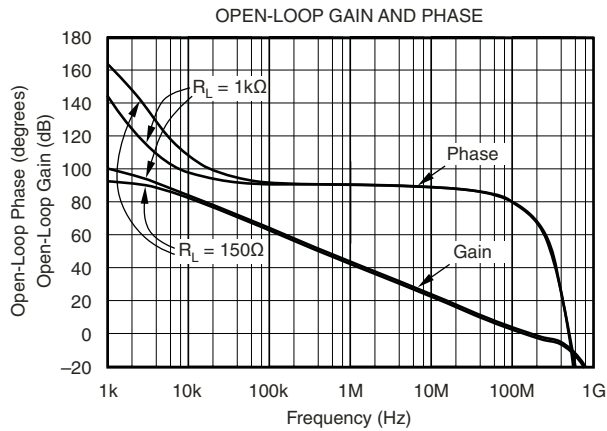
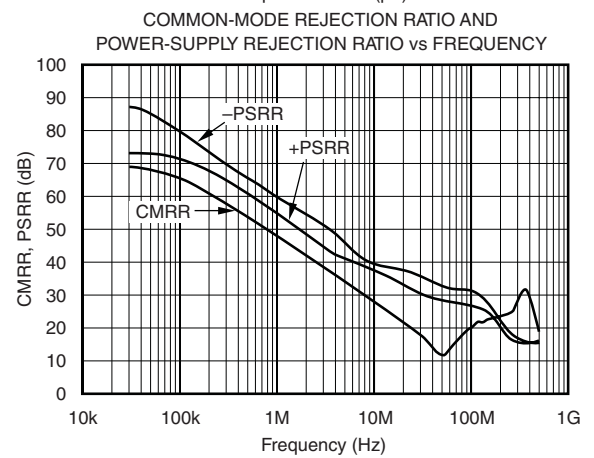
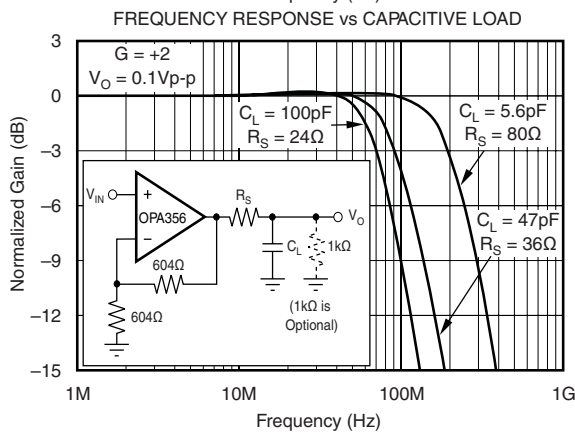
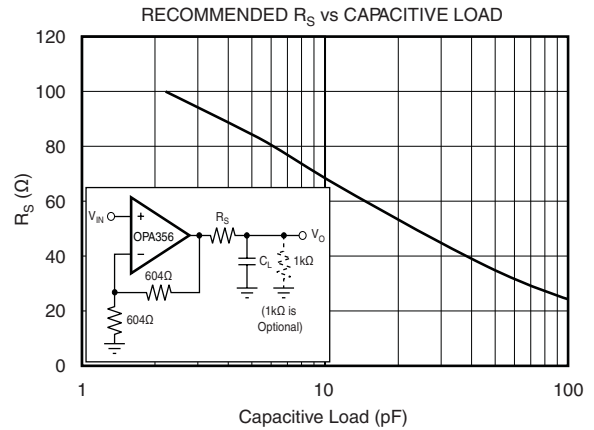
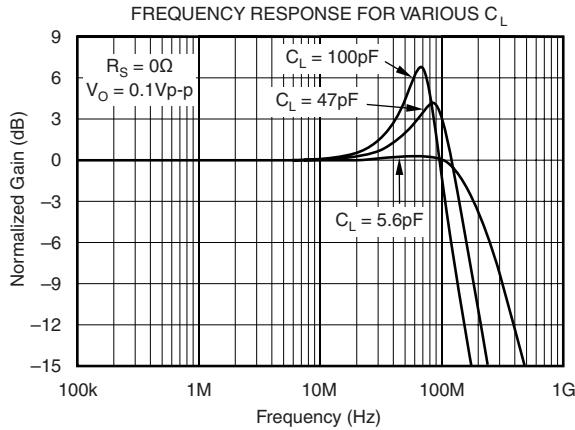

TYPICAL CHARACTERISTICS (continued)

$T_A = 25^\circ\text{C}$, $V_S = 5\text{ V}$, $G = 2$, $R_F = 604\ \Omega$, $R_L = 150\ \Omega$ connected to $V_S / 2$ (unless otherwise noted)

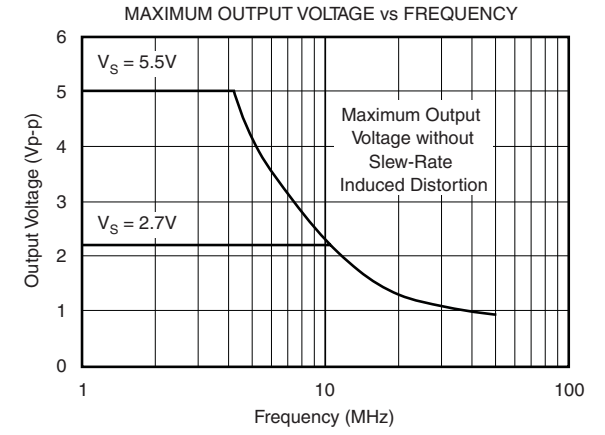
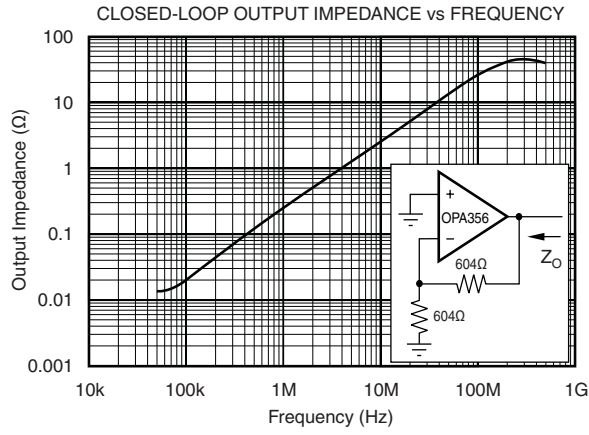
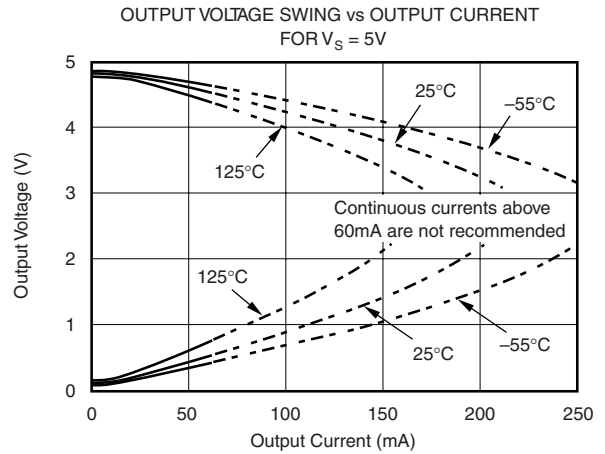
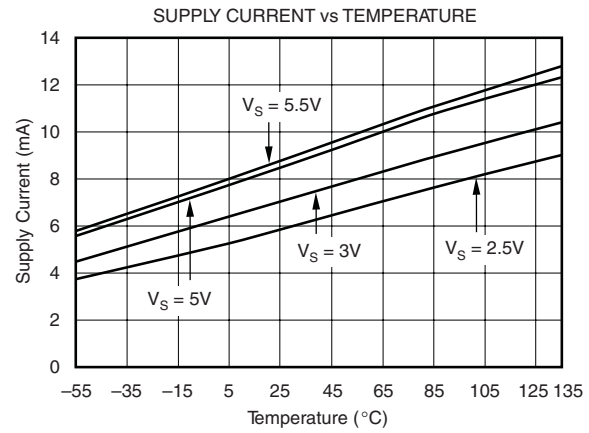
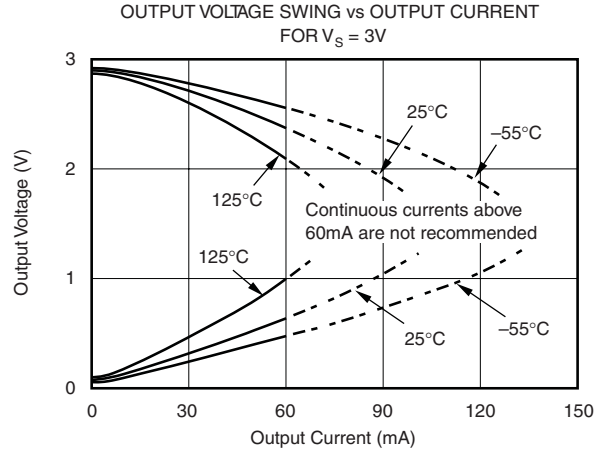
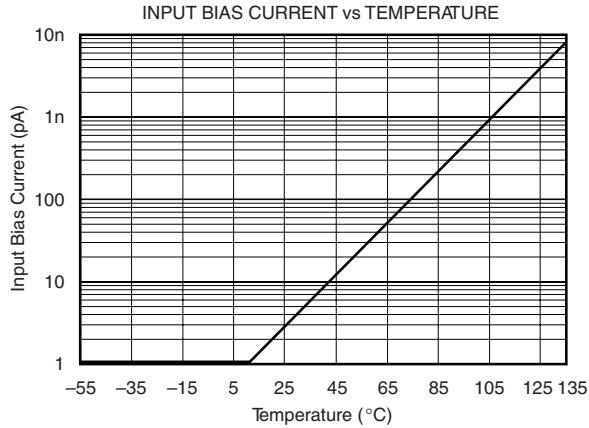

Downloaded from [Datasheet.su](#)

TYPICAL CHARACTERISTICS (continued)

$T_A = 25^\circ\text{C}$, $V_S = 5\text{ V}$, $G = 2$, $R_F = 604\ \Omega$, $R_L = 150\ \Omega$ connected to $V_S / 2$ (unless otherwise noted)

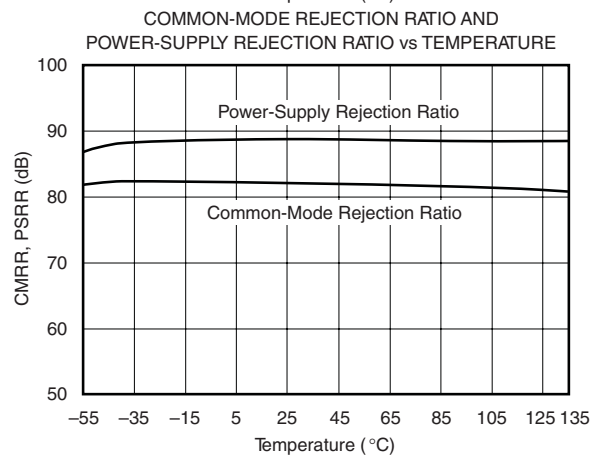
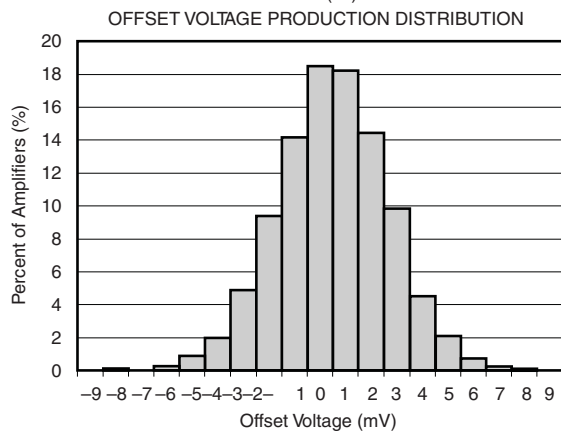
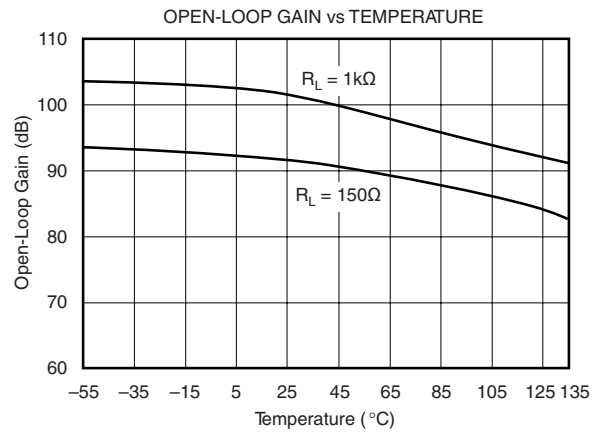
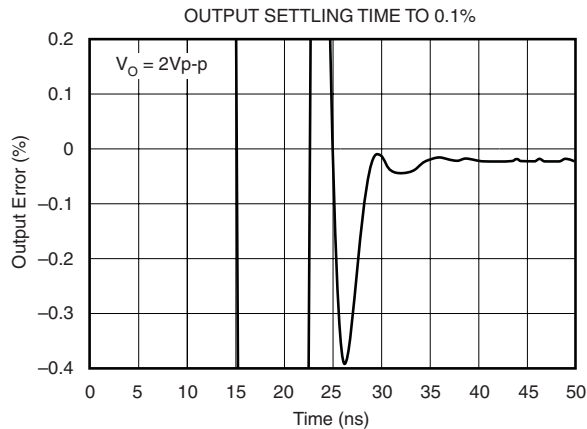

APPLICATION INFORMATION

The OPA2356-Q1 is a CMOS high-speed voltage-feedback operational amplifier designed for video and other general-purpose applications.

The amplifier features a 200-MHz gain bandwidth and 360-V/ μ s slew rate, but it is unity-gain stable and can be operated as a 1-V/V voltage follower.

Its input common-mode voltage range includes ground, allowing the OPA2356-Q1 to be used in virtually any single-supply application up to a supply voltage of 5.5 V.

PCB Layout

Good high-frequency PC board layout techniques should be employed for the OPA2356-Q1. Generous use of ground planes, short direct signal traces, and a suitable bypass capacitor located at the V+ pin assure clean, stable operation. Large areas of copper also provide a means of dissipating heat that is generated within the amplifier in normal operation.

Sockets are definitely not recommended for use with any high-speed amplifier.

A 10- μ F ceramic bypass capacitor is the minimum recommended value; adding a 1- μ F or larger tantalum capacitor in parallel can be beneficial when driving a low-resistance load. Providing adequate bypass capacitance is essential to achieving very low harmonic and intermodulation distortion.

Operating Voltage

The OPA2356-Q1 is specified over a power-supply range of 2.7 V to 5.5 V (± 1.35 V to ± 2.75 V). However, the supply voltage may range from 2.5 V to 5.5 V (± 1.25 V to ± 2.75 V). Supply voltages higher than 7.5 V (absolute maximum) can permanently damage the amplifier.

Parameters that vary significantly over supply voltage or temperature are shown in the [Typical Characteristics](#) section of this data sheet.

Output Drive

The OPA2356-Q1 output stage is capable of driving a standard back-terminated 75- Ω video cable. By back-terminating a transmission line, it does not exhibit a capacitive load to its driver. A properly back-terminated 75- Ω cable does not appear as capacitance; it presents only a 150- Ω resistive load to the OPA2356-Q1 output.

The output stage can supply high short-circuit current (typically over 200 mA). Therefore, an on-chip thermal shutdown circuit is provided to protect the OPA2356-Q1 from dangerously high junction temperatures. At 160°C, the protection circuit will shut down the amplifier. Normal operation will resume when the junction temperature cools to below 140°C.

NOTE

It is not recommended to run a continuous dc current in excess of ± 60 mA. See the Output Voltage Swing vs Output Current graph in the [Typical Characteristics](#) section of this data sheet.

Input and ESD Protection

All OPA2356-Q1 pins are static protected with internal ESD protection diodes tied to the supplies, as shown in Figure 1. These diodes provide overdrive protection if the current is externally limited to 10 mA by the source or by a resistor.

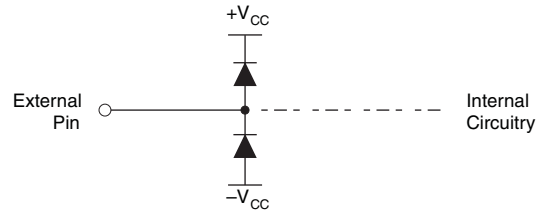

Figure 1. Internal ESD Protection



www.ti.com

PACKAGE OPTION ADDENDUM

23-Oct-2012

PACKAGING INFORMATION

Orderable Device	Status ⁽¹⁾	Package Type	Package Drawing	Pins	Package Qty	Eco Plan ⁽²⁾	Lead/ Ball Finish	MSL Peak Temp ⁽³⁾	Samples (Requires Login)
OPA2356AQDGKRQ1	PREVIEW	VSSOP	DGK	8	2500	TBD	Call TI	Call TI	

⁽¹⁾ The marketing status values are defined as follows:

ACTIVE: Product device recommended for new designs.

LIFEBUY: TI has announced that the device will be discontinued, and a lifetime-buy period is in effect.

NRND: Not recommended for new designs. Device is in production to support existing customers, but TI does not recommend using this part in a new design.

PREVIEW: Device has been announced but is not in production. Samples may or may not be available.

OBSOLETE: TI has discontinued the production of the device.

⁽²⁾ Eco Plan - The planned eco-friendly classification: Pb-Free (RoHS), Pb-Free (RoHS Exempt), or Green (RoHS & no Sb/Br) - please check <http://www.ti.com/productcontent> for the latest availability information and additional product content details.

TBD: The Pb-Free/Green conversion plan has not been defined.

Pb-Free (RoHS): TI's terms "Lead-Free" or "Pb-Free" mean semiconductor products that are compatible with the current RoHS requirements for all 6 substances, including the requirement that lead not exceed 0.1% by weight in homogeneous materials. Where designed to be soldered at high temperatures, TI Pb-Free products are suitable for use in specified lead-free processes.

Pb-Free (RoHS Exempt): This component has a RoHS exemption for either 1) lead-based flip-chip solder bumps used between the die and package, or 2) lead-based die adhesive used between the die and leadframe. The component is otherwise considered Pb-Free (RoHS compatible) as defined above.

Green (RoHS & no Sb/Br): TI defines "Green" to mean Pb-Free (RoHS compatible), and free of Bromine (Br) and Antimony (Sb) based flame retardants (Br or Sb do not exceed 0.1% by weight in homogeneous material)

⁽³⁾ MSL, Peak Temp. -- The Moisture Sensitivity Level rating according to the JEDEC industry standard classifications, and peak solder temperature.

Important Information and Disclaimer: The information provided on this page represents TI's knowledge and belief as of the date that it is provided. TI bases its knowledge and belief on information provided by third parties, and makes no representation or warranty as to the accuracy of such information. Efforts are underway to better integrate information from third parties. TI has taken and continues to take reasonable steps to provide representative and accurate information but may not have conducted destructive testing or chemical analysis on incoming materials and chemicals. TI and TI suppliers consider certain information to be proprietary, and thus CAS numbers and other limited information may not be available for release.

In no event shall TI's liability arising out of such information exceed the total purchase price of the TI part(s) at issue in this document sold by TI to Customer on an annual basis.

OTHER QUALIFIED VERSIONS OF OPA2356-Q1 :

- Catalog: [OPA2356](#)

NOTE: Qualified Version Definitions:

- Catalog - TI's standard catalog product

DGK (S-PDSO-G8)

PLASTIC SMALL-OUTLINE PACKAGE

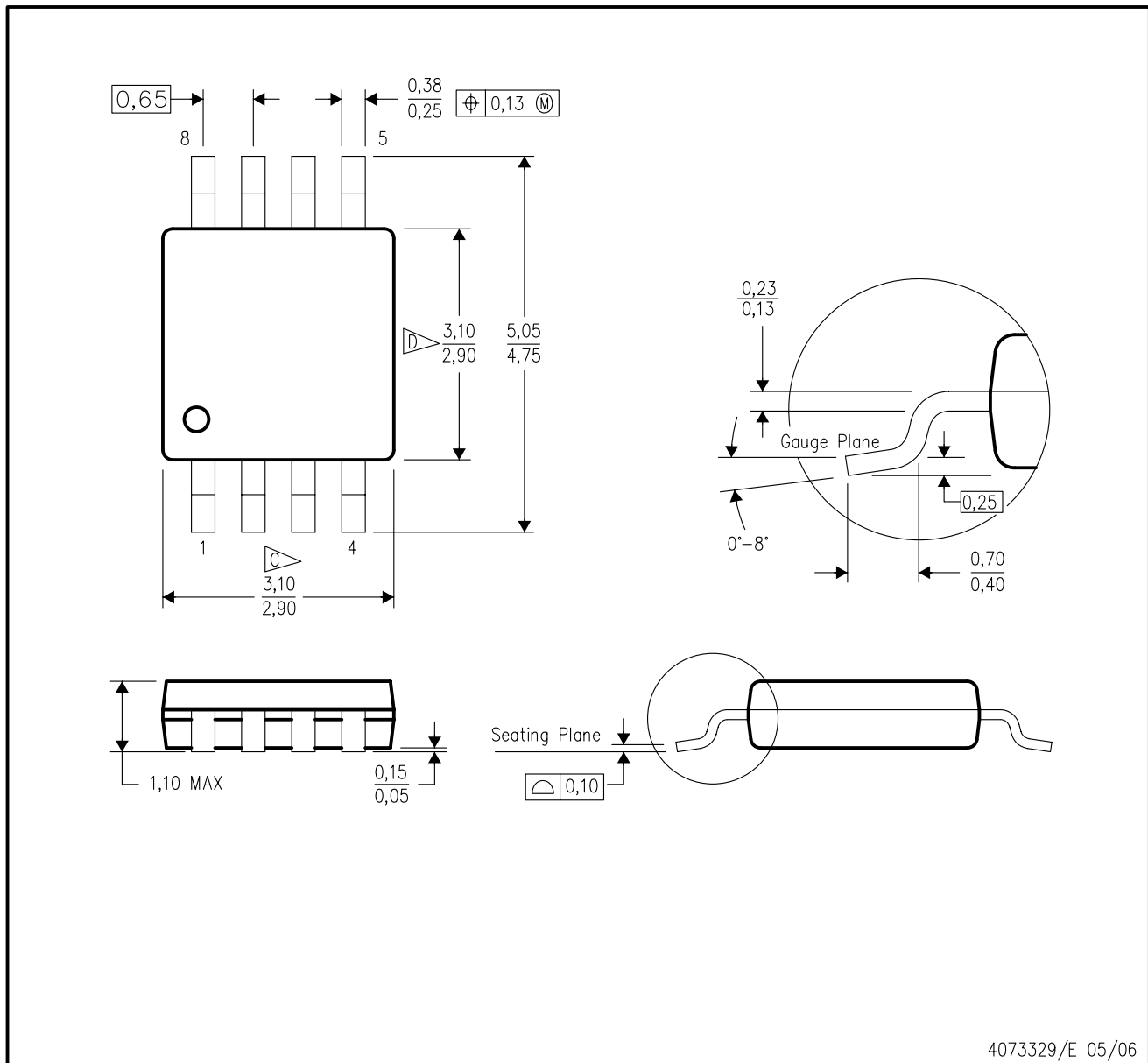

- NOTES:
- A. All linear dimensions are in millimeters.
 - B. This drawing is subject to change without notice.
 - C. Body length does not include mold flash, protrusions, or gate burrs. Mold flash, protrusions, or gate burrs shall not exceed 0.15 per end.
 - D. Body width does not include interlead flash. Interlead flash shall not exceed 0.50 per side.
 - E. Falls within JEDEC MO-187 variation AA, except interlead flash.

IMPORTANT NOTICE

Texas Instruments Incorporated and its subsidiaries (TI) reserve the right to make corrections, enhancements, improvements and other changes to its semiconductor products and services per JESD46, latest issue, and to discontinue any product or service per JESD48, latest issue. Buyers should obtain the latest relevant information before placing orders and should verify that such information is current and complete. All semiconductor products (also referred to herein as "components") are sold subject to TI's terms and conditions of sale supplied at the time of order acknowledgment.

TI warrants performance of its components to the specifications applicable at the time of sale, in accordance with the warranty in TI's terms and conditions of sale of semiconductor products. Testing and other quality control techniques are used to the extent TI deems necessary to support this warranty. Except where mandated by applicable law, testing of all parameters of each component is not necessarily performed.

TI assumes no liability for applications assistance or the design of Buyers' products. Buyers are responsible for their products and applications using TI components. To minimize the risks associated with Buyers' products and applications, Buyers should provide adequate design and operating safeguards.

TI does not warrant or represent that any license, either express or implied, is granted under any patent right, copyright, mask work right, or other intellectual property right relating to any combination, machine, or process in which TI components or services are used. Information published by TI regarding third-party products or services does not constitute a license to use such products or services or a warranty or endorsement thereof. Use of such information may require a license from a third party under the patents or other intellectual property of the third party, or a license from TI under the patents or other intellectual property of TI.

Reproduction of significant portions of TI information in TI data books or data sheets is permissible only if reproduction is without alteration and is accompanied by all associated warranties, conditions, limitations, and notices. TI is not responsible or liable for such altered documentation. Information of third parties may be subject to additional restrictions.

Resale of TI components or services with statements different from or beyond the parameters stated by TI for that component or service voids all express and any implied warranties for the associated TI component or service and is an unfair and deceptive business practice. TI is not responsible or liable for any such statements.

Buyer acknowledges and agrees that it is solely responsible for compliance with all legal, regulatory and safety-related requirements concerning its products, and any use of TI components in its applications, notwithstanding any applications-related information or support that may be provided by TI. Buyer represents and agrees that it has all the necessary expertise to create and implement safeguards which anticipate dangerous consequences of failures, monitor failures and their consequences, lessen the likelihood of failures that might cause harm and take appropriate remedial actions. Buyer will fully indemnify TI and its representatives against any damages arising out of the use of any TI components in safety-critical applications.

In some cases, TI components may be promoted specifically to facilitate safety-related applications. With such components, TI's goal is to help enable customers to design and create their own end-product solutions that meet applicable functional safety standards and requirements. Nonetheless, such components are subject to these terms.

No TI components are authorized for use in FDA Class III (or similar life-critical medical equipment) unless authorized officers of the parties have executed a special agreement specifically governing such use.

Only those TI components which TI has specifically designated as military grade or "enhanced plastic" are designed and intended for use in military/aerospace applications or environments. Buyer acknowledges and agrees that any military or aerospace use of TI components which have **not** been so designated is solely at the Buyer's risk, and that Buyer is solely responsible for compliance with all legal and regulatory requirements in connection with such use.

TI has specifically designated certain components which meet ISO/TS16949 requirements, mainly for automotive use. Components which have not been so designated are neither designed nor intended for automotive use; and TI will not be responsible for any failure of such components to meet such requirements.

Products

Audio	www.ti.com/audio
Amplifiers	amplifier.ti.com
Data Converters	dataconverter.ti.com
DLP® Products	www.dlp.com
DSP	dsp.ti.com
Clocks and Timers	www.ti.com/clocks
Interface	interface.ti.com
Logic	logic.ti.com
Power Mgmt	power.ti.com
Microcontrollers	microcontroller.ti.com
RFID	www.ti-rfid.com
OMAP Applications Processors	www.ti.com/omap
Wireless Connectivity	www.ti.com/wirelessconnectivity

Applications

Automotive and Transportation	www.ti.com/automotive
Communications and Telecom	www.ti.com/communications
Computers and Peripherals	www.ti.com/computers
Consumer Electronics	www.ti.com/consumer-apps
Energy and Lighting	www.ti.com/energy
Industrial	www.ti.com/industrial
Medical	www.ti.com/medical
Security	www.ti.com/security
Space, Avionics and Defense	www.ti.com/space-avionics-defense
Video and Imaging	www.ti.com/video

TI E2E Community

e2e.ti.com

Mailing Address: Texas Instruments, Post Office Box 655303, Dallas, Texas 75265
Copyright © 2012, Texas Instruments Incorporated