



MCH6337 — General-Purpose Switching Device Applications

P-Channel Silicon MOSFET

Features

- Low ON-resistance
- 1.8V drive
- Protection diode in
- Ultrahigh-speed switching
- Halogen free compliance

Specifications

Absolute Maximum Ratings at Ta=25°C

Parameter	Symbol	Conditions	Ratings	Unit
Drain-to-Source Voltage	VDSS		-20	V
Gate-to-Source Voltage	VGSS		±10	V
Drain Current (DC)	ID		-4.5	A
Drain Current (Pulse)	IDP	PW≤10μs, duty cycle≤1%	-18	A
Allowable Power Dissipation	PD	When mounted on ceramic substrate (1200mm²×0.8mm)	1.5	W
Channel Temperature	Tch		150	°C
Storage Temperature	Tstg		-55 to +150	°C

Package Dimensions

unit : mm (typ)

7022A-009

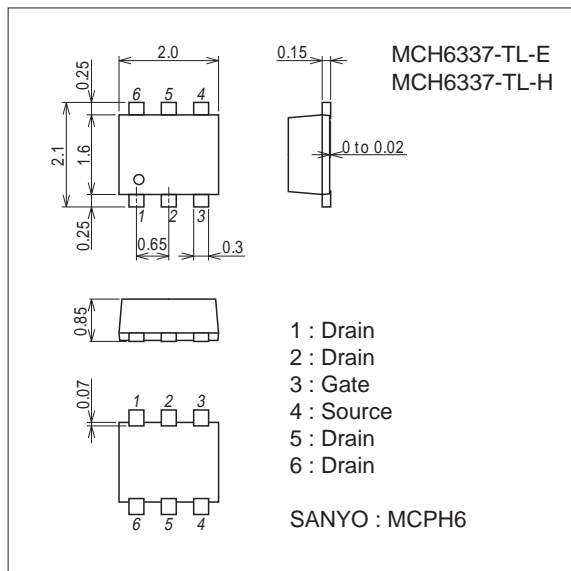

Product & Package Information

- Package : MCPH6
- JEITA, JEDEC : SC-88, SC-70-6, SOT-363
- Minimum Packing Quantity : 3,000 pcs./reel

Packing Type : TL

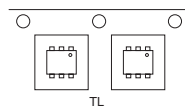

Marking

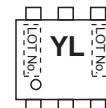

Electrical Connection

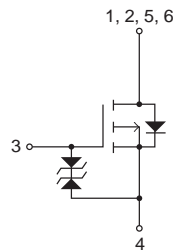

MCH6337

Electrical Characteristics at $T_a=25^\circ\text{C}$

Parameter	Symbol	Conditions	Ratings			Unit
			min	typ	max	
Drain-to-Source Breakdown Voltage	$V_{(BR)DSS}$	$I_D=-1\text{mA}, V_{GS}=0\text{V}$	-20			V
Zero-Gate Voltage Drain Current	I_{DSS}	$V_{DS}=-20\text{V}, V_{GS}=0\text{V}$			-1	μA
Gate-to-Source Leakage Current	I_{GSS}	$V_{GS}=\pm 8\text{V}, V_{DS}=0\text{V}$			± 10	μA
Cutoff Voltage	$V_{GS(off)}$	$V_{DS}=-10\text{V}, I_D=-1\text{mA}$	-0.4		-1.3	V
Forward Transfer Admittance	$ y_{fs} $	$V_{DS}=-10\text{V}, I_D=-3\text{A}$	3.5	5.9		S
Static Drain-to-Source On-State Resistance	$R_{DS(on)1}$	$I_D=-3\text{A}, V_{GS}=-4.5\text{V}$		37	49	$\text{m}\Omega$
	$R_{DS(on)2}$	$I_D=-1.5\text{A}, V_{GS}=-2.5\text{V}$		53	75	$\text{m}\Omega$
	$R_{DS(on)3}$	$I_D=-0.5\text{A}, V_{GS}=-1.8\text{V}$		85	130	$\text{m}\Omega$
Input Capacitance	C_{iss}	$V_{DS}=-10\text{V}, f=1\text{MHz}$		670		pF
Output Capacitance	C_{oss}			130		pF
Reverse Transfer Capacitance	C_{rss}			94		pF
Turn-ON Delay Time	$t_d(on)$		See specified Test Circuit.		8.4	
Rise Time	t_r			45		ns
Turn-OFF Delay Time	$t_d(off)$			69		ns
Fall Time	t_f			63		ns
Total Gate Charge	Q_g	$V_{DS}=-10\text{V}, V_{GS}=-4.5\text{V}, I_D=-4.5\text{A}$			7.3	
Gate-to-Source Charge	Q_{gs}			1.3		nC
Gate-to-Drain "Miller" Charge	Q_{gd}			2.1		nC
Diode Forward Voltage	V_{SD}	$I_S=-4.5\text{A}, V_{GS}=0\text{V}$		-0.82	-1.2	V

Switching Time Test Circuit

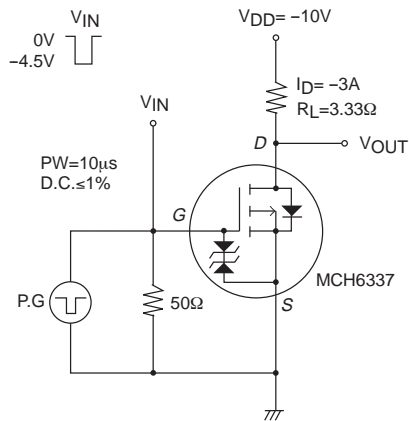

Ordering Information

Device	Package	Shipping	memo
MCH6337-TL-E	MCPH6	3,000pcs./reel	Pb Free
MCH6337-TL-H	MCPH6	3,000pcs./reel	Pb Free and Halogen Free

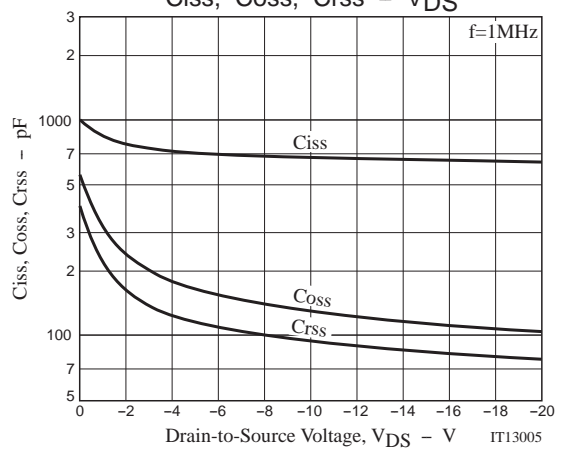
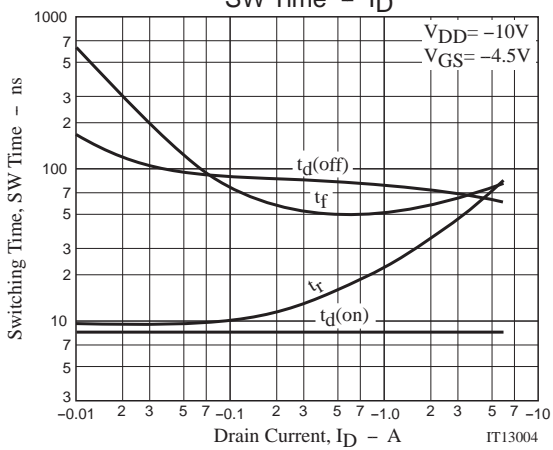
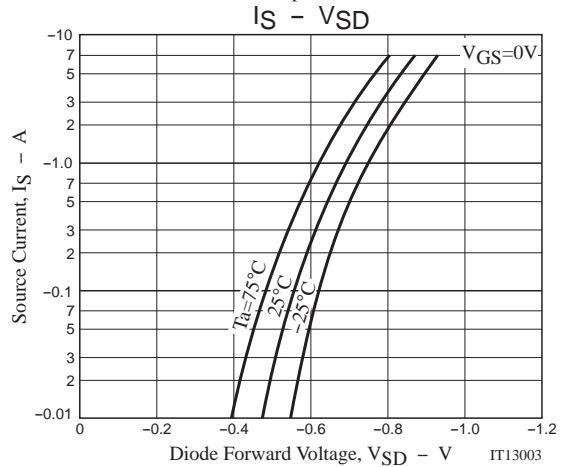
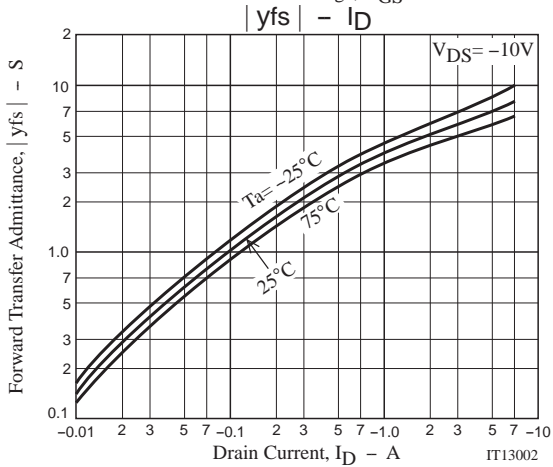
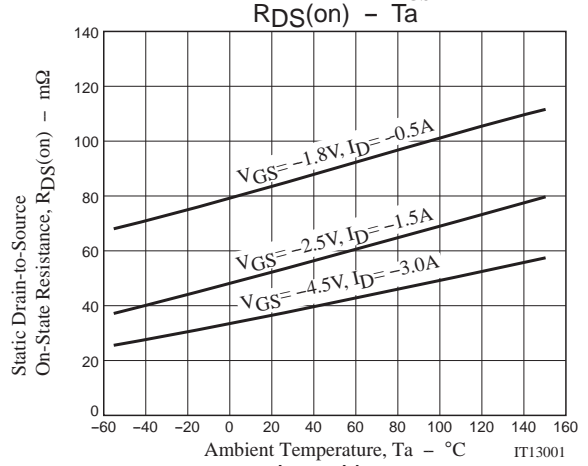
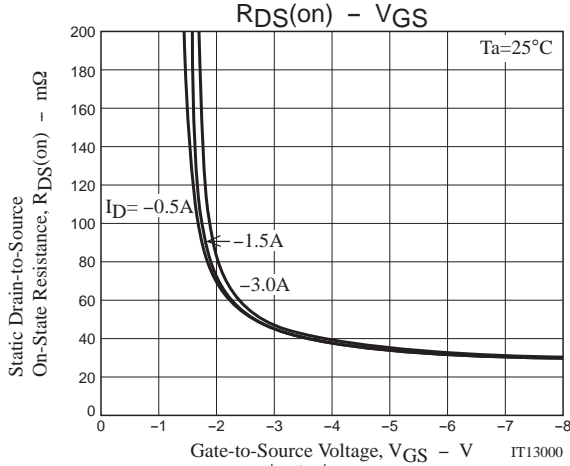
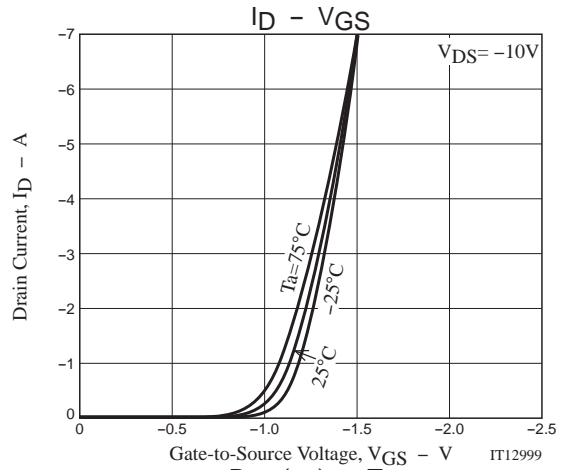
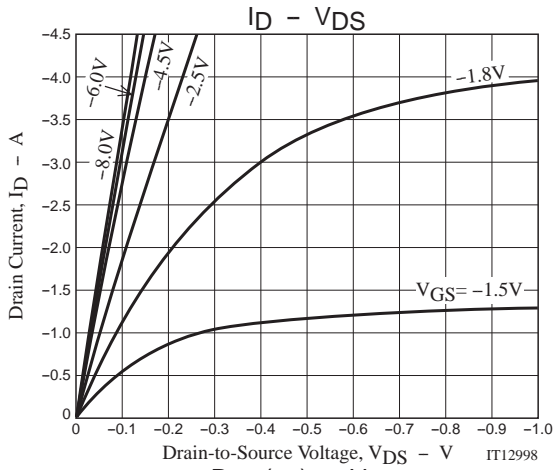

MCH6337

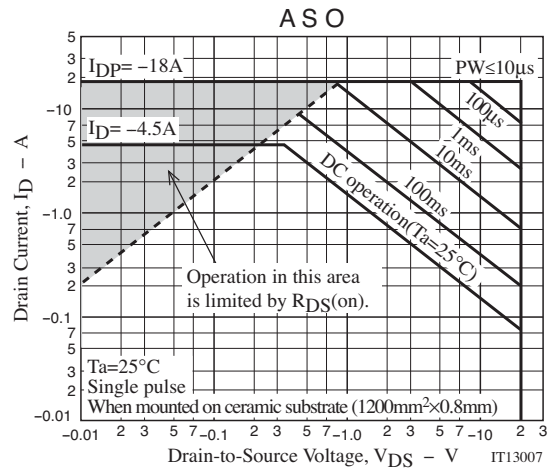
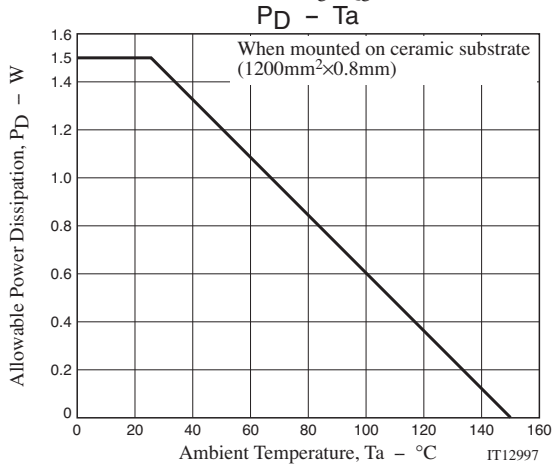
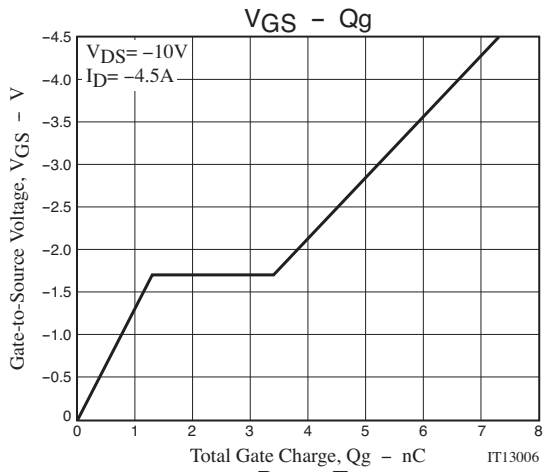

Taping Specification

MCH6337-TL-E, MCH6337-TL-H

1. Packing Format

Package Name	Carrier Tape Type	Maximum Number of devices contained (tcs)			Packing format	
		Reel	Inner box	Outer box	Inner BOX (C-1)	Outer BOX (A-7)
MCPH6	MCP4	3,000	15,000	90,000	5 reels contained Dimensions:mm (external) 183×72×185	6 inner boxes contained Dimensions:mm (external) 440×195×210

Packing method

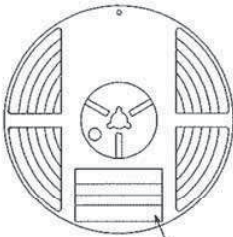

Reel label

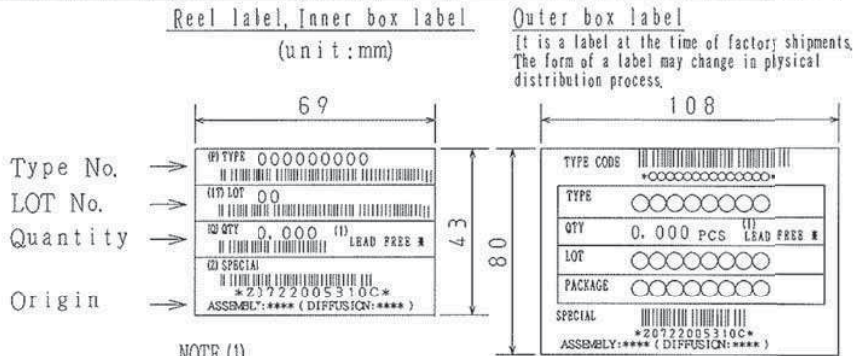

NOTE (1)

The LEAD FREE * description shows that the surface treatment of the terminal is lead free.

Label	JEITA Phase
LEAD FREE 3	JEITA Phase 3A
LEAD FREE 4	JEITA Phase 3

2. Taping configuration

2-1. Carrier tape size (unit:mm)

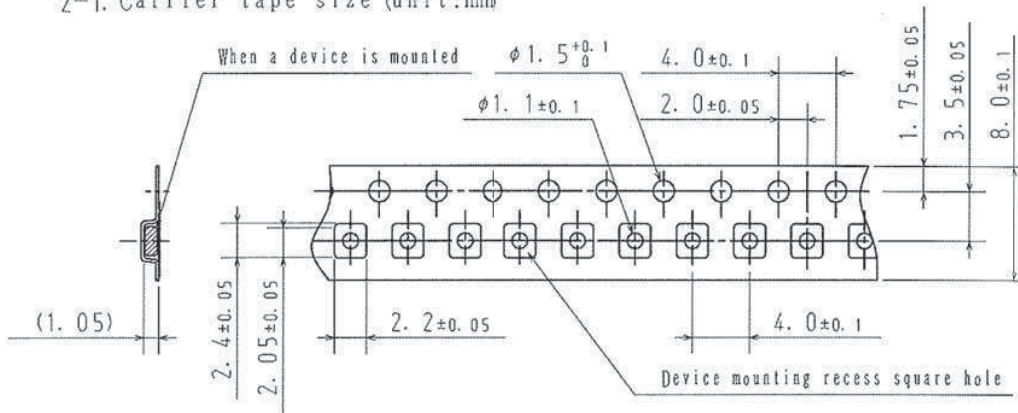

2-2. Device placement direction

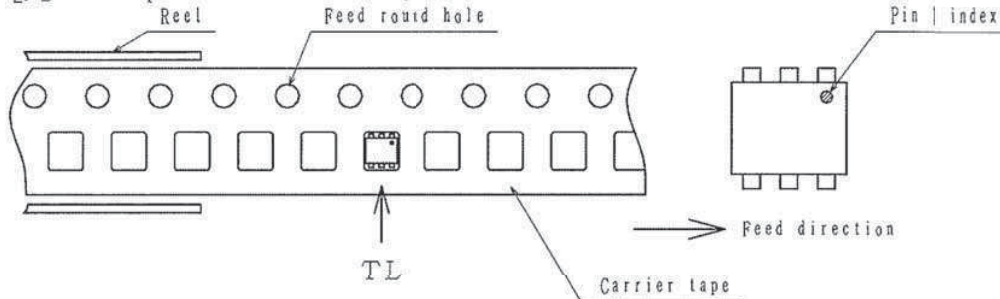

Those with pin 1 index on the feed hole side.....TL

MCH6337

Outline Drawing

MCH6337-TL-E, MCH6337-TL-H

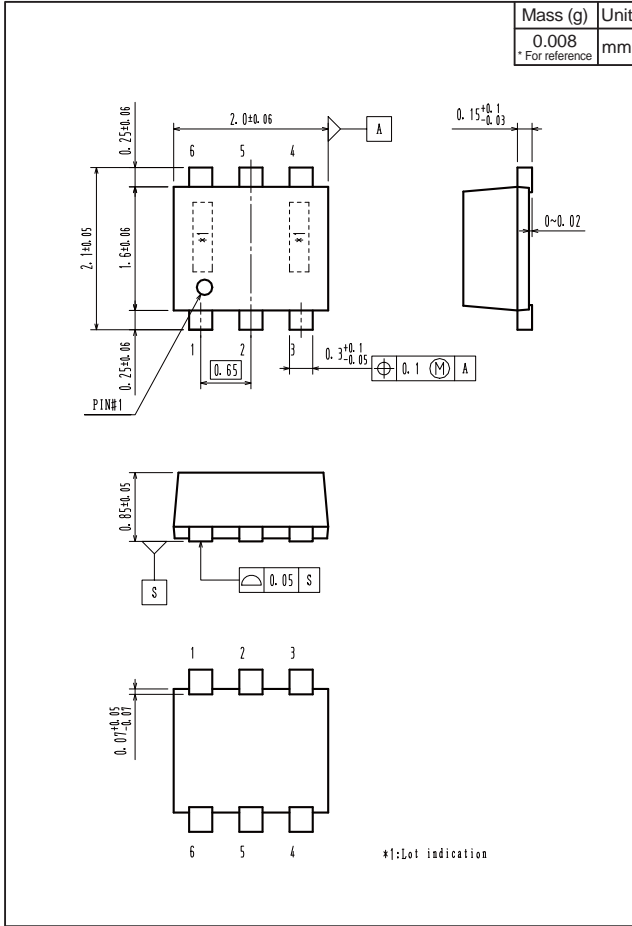

Land Pattern Example

Unit: mm

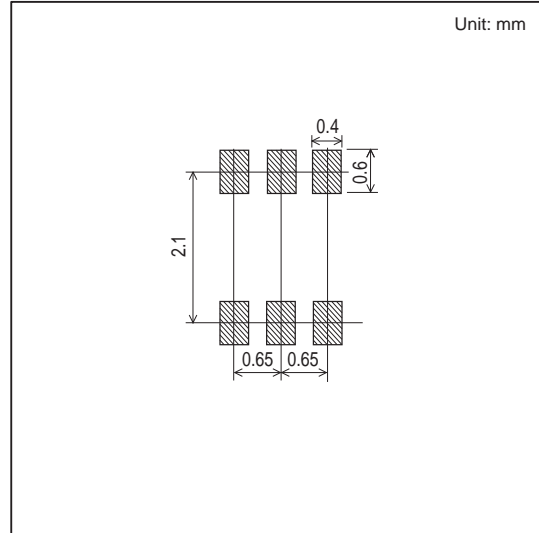

Note on usage : Since the MCH6337 is a MOSFET product, please avoid using this device in the vicinity of highly charged objects.

- Any and all SANYO Semiconductor Co.,Ltd. products described or contained herein are, with regard to "standard application", intended for the use as general electronics equipment. The products mentioned herein shall not be intended for use for any "special application" (medical equipment whose purpose is to sustain life, aerospace instrument, nuclear control device, burning appliances, transportation machine, traffic signal system, safety equipment etc.) that shall require extremely high level of reliability and can directly threaten human lives in case of failure or malfunction of the product or may cause harm to human bodies, nor shall they grant any guarantee thereof. If you should intend to use our products for new introduction or other application different from current conditions on the usage of automotive device, communication device, office equipment, industrial equipment etc. , please consult with us about usage condition (temperature, operation time etc.) prior to the intended use. If there is no consultation or inquiry before the intended use, our customer shall be solely responsible for the use.
- Specifications of any and all SANYO Semiconductor Co.,Ltd. products described or contained herein stipulate the performance, characteristics, and functions of the described products in the independent state, and are not guarantees of the performance, characteristics, and functions of the described products as mounted in the customer's products or equipment. To verify symptoms and states that cannot be evaluated in an independent device, the customer should always evaluate and test devices mounted in the customer's products or equipment.
- SANYO Semiconductor Co.,Ltd. assumes no responsibility for equipment failures that result from using products at values that exceed, even momentarily, rated values (such as maximum ratings, operating condition ranges, or other parameters) listed in products specifications of any and all SANYO Semiconductor Co.,Ltd. products described or contained herein.
- Regarding monolithic semiconductors, if you should intend to use this IC continuously under high temperature, high current, high voltage, or drastic temperature change, even if it is used within the range of absolute maximum ratings or operating conditions, there is a possibility of decrease reliability. Please contact us for a confirmation.
- SANYO Semiconductor Co.,Ltd. strives to supply high-quality high-reliability products, however, any and all semiconductor products fail or malfunction with some probability. It is possible that these probabilistic failures or malfunction could give rise to accidents or events that could endanger human lives, trouble that could give rise to smoke or fire, or accidents that could cause damage to other property. When designing equipment, adopt safety measures so that these kinds of accidents or events cannot occur. Such measures include but are not limited to protective circuits and error prevention circuits for safe design, redundant design, and structural design.
- In the event that any or all SANYO Semiconductor Co.,Ltd. products described or contained herein are controlled under any of applicable local export control laws and regulations, such products may require the export license from the authorities concerned in accordance with the above law.
- No part of this publication may be reproduced or transmitted in any form or by any means, electronic or mechanical, including photocopying and recording, or any information storage or retrieval system, or otherwise, without the prior written consent of SANYO Semiconductor Co.,Ltd.
- Any and all information described or contained herein are subject to change without notice due to product/technology improvement, etc. When designing equipment, refer to the "Delivery Specification" for the SANYO Semiconductor Co.,Ltd. product that you intend to use.
- Upon using the technical information or products described herein, neither warranty nor license shall be granted with regard to intellectual property rights or any other rights of SANYO Semiconductor Co.,Ltd. or any third party. SANYO Semiconductor Co.,Ltd. shall not be liable for any claim or suits with regard to a third party's intellectual property rights which has resulted from the use of the technical information and products mentioned above.

This catalog provides information as of June, 2012. Specifications and information herein are subject to change without notice.