

A New High-performance Controller: High Resolution, High Speed, and High Input Accuracy.

Logic Operations and Preventive Maintenance Function. Plus Infrared Port on Front Panel.

- High-resolution display with 5 digits/0.01°C display.
- High-speed sampling cycle of 60 ms.
- High Accuracy
Thermocouple/Pt input: $\pm 0.1\%$ of PV
Analog input: $\pm 0.1\%$ FS
- Universal inputs on all models (thermocouple, PT, or analog input) to handle various sensors with one Controller. Models also available with Remote SP.
- A PV/SV-status display function can be set to automatically alternate between displaying the status of the Temperature Controller (auto/manual, RUN/STOP, and alarms) and the PV or SV.
- Flexible contact outputs with logic operations (AND, OR, and delays) set from the Support Software (CX-Thermo Ver. 4.0)
- Preventive maintenance for relays in the Temperature Controller using a Control Output ON/OFF Counter.
- Model available with position-proportional control



⚠ Refer to Safety Precautions for E5□N/E5□N-H.

Main I/O Functions

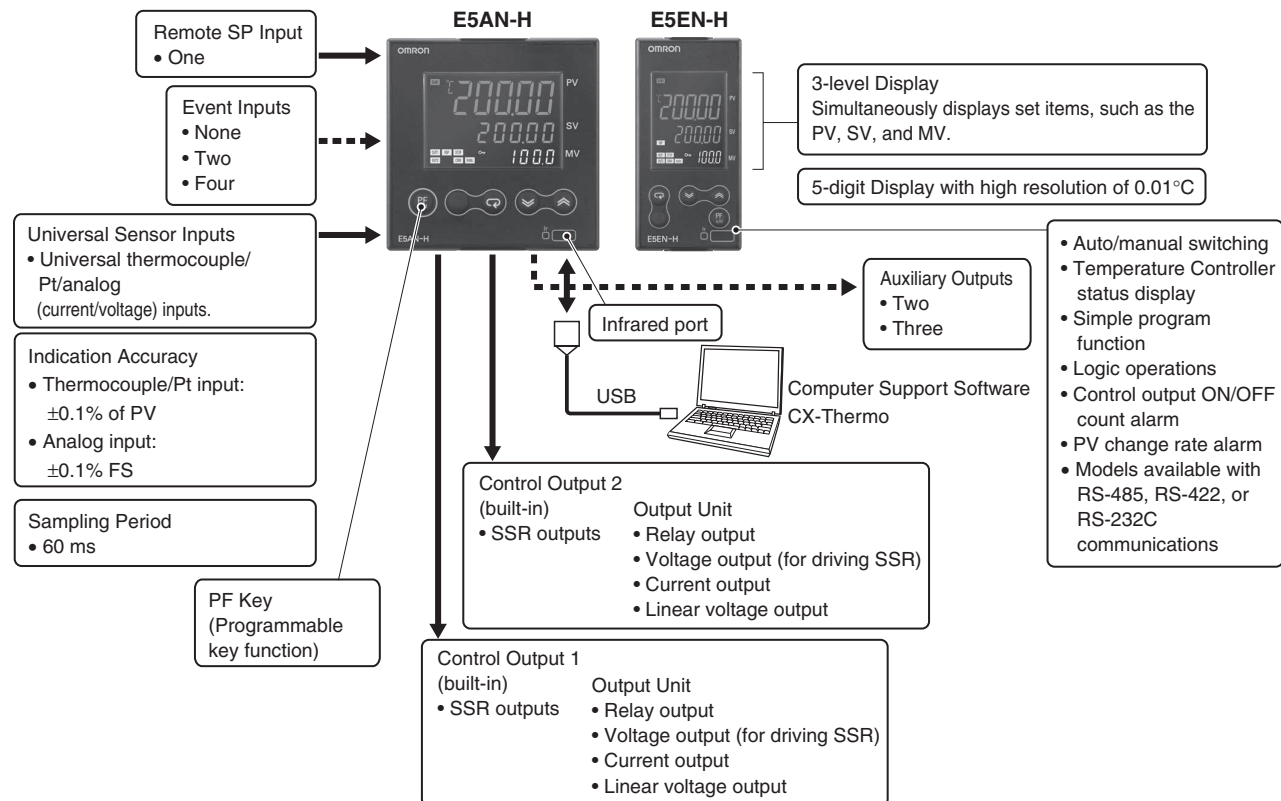

Lineup



Note: The Controller can be used for heating/cooling control even if only 1 control output is used.

Model Number Structure

Model Number Legend

Controllers

E5AN/E5EN- M - -500

1 2 3 4 5 6 7 8 9 10 11

1. Type

H: Advanced

2. Control Mode

Blank: Standard or heating/cooling control
P: Position-proportional control

3. Control Output 1

A: Control Output Unit
R: Relay output
S: SSR output

4. Control Output 2

A: Control Output Unit
R: Relay output
S: SSR output

5. Auxiliary Outputs

2: Two outputs
3: Three outputs

6. Option 1

Blank: None
H: Heater burnout/SSR failure/Heater overcurrent detection (CT1)
HH: Heater burnout/SSR failure/Heater overcurrent detection (CT2)

7. Option 2

B: Two event inputs
BF: Event input + Transfer output

8. Option 3

M: Option Unit can be mounted.

9. Power Supply Voltage

Blank: 100 to 240 VAC
D: 24 VAC/VDC

10. Case Color

Blank: Black
W: Silver

11. Terminal Cover

-500: With Terminal Cover

Option Units

E53-

1

1. Function

EN01: RS-232C communications
EN02: RS-422 communications
EN03: RS-485 communications
AKB: Event input

Output Units

E53-

1 2

1. Control Output

R: Relay output
Q: Voltage output (for driving SSR)
Q3: Voltage output (for driving SSR) + 24 VDC (NPN)
Q4: Voltage output (for driving SSR) + 24 VDC (PNP)
C3: Current output + 4 to 20 mA DC
C3D: Current output + 0 to 20 mA DC
V34: Linear voltage output + 0 to 10 VDC
V35: Linear voltage output + 0 to 5 VDC

2. Version

Blank: Available for E5AN-E5EN-H and E5AK/E5EK.
N: Available only for E5AN-H/E5EN-H.

This data sheet is provided as a guideline for selecting products. Be sure to refer to the following user manuals for application precautions and other information required for operation before attempting to use the product.

E5CN-H/E5AN-H/E5EN-H Digital Controllers User's Manual Advanced Type (Cat. No. H157)

E5CN-H/E5AN-H/E5EN-H Digital Controllers Communications Manual Advanced Type (Cat. No. H159)

Ordering Information

E5AN-H

Size	Case color	Power supply voltage	Control method	Auxiliary output	Control output 1/2	Heater burnout	Optional functions			Model	
							Event inputs	Transfer output	RSP		
1/4 DIN 96 × 96 × 78 (W × H × D)	Black	100 to 240 VAC	Basic	2	Control Output Unit × 2	1	2		4 to 20-mA input	E5AN-HAA2HBM-500	
					SSR outputs × 2	1	2		4 to 20-mA input	E5AN-HSS2HBM-500	
				Control Output Unit × 2	2	2	4 to 20-mA output	4 to 20-mA input	E5AN-HAA2HHBFM-500		
				SSR outputs × 2	2	2	4 to 20-mA output	4 to 20-mA input	E5AN-HSS2HHBFM-500		
			3	Control Output Unit × 2		2	4 to 20-mA output	4 to 20-mA input	E5AN-HAA3BFM-500		
				SSR outputs × 2		2	4 to 20-mA output	4 to 20-mA input	E5AN-HSS3BFM-500		
		Valve	2	Relay outputs × 2		2		4 to 20-mA input	E5AN-HPRR2BM-500		
				Relay outputs × 2		2	4 to 20-mA output	4 to 20-mA input	E5AN-HPRR2BFM-500		
		24 VAC/ VDC	Basic	2	2	Control Output Unit × 2	1	2		4 to 20-mA input	E5AN-HAA2HBMD-500
						SSR outputs × 2	1	2		4 to 20-mA input	E5AN-HSS2HBMD-500
				Control Output Unit × 2	2	2	4 to 20-mA output	4 to 20-mA input	E5AN-HAA2HHBFMD-500		
				SSR outputs × 2	2	2	4 to 20-mA output	4 to 20-mA input	E5AN-HSS2HHBFMD-500		
	3		Control Output Unit × 2		2	4 to 20-mA output	4 to 20-mA input	E5AN-HAA3BFMD-500			
			SSR outputs × 2		2	4 to 20-mA output	4 to 20-mA input	E5AN-HSS3BFMD-500			
	Valve	2	Relay outputs × 2		2		4 to 20-mA input	E5AN-HPRR2BMD-500			
			Relay outputs × 2		2	4 to 20-mA output	4 to 20-mA input	E5AN-HPRR2BFMD-500			
	Silver	100 to 240 VAC	Basic	2	Control Output Unit × 2	1	2		4 to 20-mA input	E5AN-HAA2HBM-W-500	
					Control Output Unit × 2	2	2	4 to 20-mA output	4 to 20-mA input	E5AN-HAA2HHBFM-W-500	
					Control Output Unit × 2	1	2		4 to 20-mA input	E5AN-HAA2HBMD-W-500	
		24 VAC/ VDC									

E5EN-H

Size	Case color	Power supply voltage	Control method	Auxiliary output	Control output 1/2	Heater burn-out	Optional Functions			Model	
							Event inputs	Transfer output	RSP		
1/8 DIN 48 × 96 × 78 (W × H × D)	Black	100 to 240 VAC	Basic	2	Control Output Unit × 2	1	2		4 to 20-mA input	E5EN-HAA2HBM-500	
					SSR outputs × 2	1	2		4 to 20-mA input	E5EN-HSS2HBM-500	
					Control Output Unit × 2	2	2	4 to 20-mA output	4 to 20-mA input	E5EN-HAA2HHBFM-500	
				SSR outputs × 2	2	2	4 to 20-mA output	4 to 20-mA input	E5EN-HSS2HHBFM-500		
				Control Output Unit × 2		2	4 to 20-mA output	4 to 20-mA input	E5EN-HAA3BFM-500		
				SSR outputs × 2		2	4 to 20-mA output	4 to 20-mA input	E5EN-HSS3BFM-500		
		Valve	2	Relay outputs × 2		2		4 to 20-mA input	E5EN-HPRR2BM-500		
				Relay outputs × 2		2	4 to 20-mA output	4 to 20-mA input	E5EN-HPRR2BFM-500		
		24 VAC/VDC	Basic	2	Control Output Unit × 2	1	2		4 to 20-mA input	E5EN-HAA2HBMD-500	
					SSR outputs × 2	1	2		4 to 20-mA input	E5EN-HSS2HBMD-500	
					Control Output Unit × 2	2	2	4 to 20-mA output	4 to 20-mA input	E5EN-HAA2HHBFMD-500	
				SSR outputs × 2	2	2	4 to 20-mA output	4 to 20-mA input	E5EN-HSS2HHBFMD-500		
	Control Output Unit × 2				2	4 to 20-mA output	4 to 20-mA input	E5EN-HAA3BFMD-500			
	SSR outputs × 2				2	4 to 20-mA output	4 to 20-mA input	E5EN-HSS3BFMD-500			
	Valve		2	Relay outputs × 2		2		4 to 20-mA input	E5EN-HPRR2BMD-500		
				Relay outputs × 2		2	4 to 20-mA output	4 to 20-mA input	E5EN-HPRR2BFMD-500		
	Silver		100 to 240 VAC	Basic	2	Control Output Unit × 2	1	2		4 to 20-mA input	E5EN-HAA2HBM-W-500
						Control Output Unit × 2	2	2	4 to 20-mA output	4 to 20-mA input	E5EN-HAA2HHBFM-W-500
						Control Output Unit × 2	1	2		4 to 20-mA input	E5EN-HAA2HBMD-W-500
			24 VAC/VDC								

Accessories (Order Separately)

Output unit	Model	Specifications
Relay output	E53-RN	SPST-NO, 250 VAC, 5 A (resistive load), electrical life: 100,000 operations
Voltage output (for driving SSR)	E53-QN	12 VDC (PNP), max. load current: 40-mA, with short-circuit protection
	E53-Q3	24 VDC (NPN), max. load current: 20-mA, with short-circuit protection
	E53-Q4	24 VDC (PNP), max. load current: 20-mA, with short-circuit protection
Current output	E53-C3N	4 to 20-mA DC, load: 600 Ω max., resolution: approx. 10,000
	E53-C3DN	0 to 20-mA DC, load: 600 Ω max., resolution: approx. 10,000
Linear voltage output	E53-V34N	0 to 10 VDC, load: 1 kΩ min., resolution: approx. 10,000
	E53-V35N	0 to 5 VDC, load: 1 kΩ min., resolution: approx. 10,000

USB-infrared Conversion Cable

Model
E58-CIFIR

USB-Serial Conversion Cable

Model
E58-CIFQ1

Terminal Cover

Connectable models	Model
E5AN-H	E53-COV16
E5EN-H	

Note: The Terminal Cover comes with the E5CN-□□□-500 models.

Waterproof Packing

Connectable models	Model
E5AN-H	Y92S-P4
E5EN-H	Y92S-P5

Note: The Waterproof Packing is included with the Controller.

Current Transformers (CTs)

Hole diameter	Model
5.8 dia.	E54-CT1
12.0 dia.	E54-CT3

CX-Thermo Support Software

Model
EST2-2C-MV4

Specifications

Ratings

Power supply voltage	No D in model number: 100 to 240 VAC, 50/60 Hz D in model number: 24 VAC, 50/60 Hz; 24 VDC	
Operating voltage range	85% to 110% of rated supply voltage	
Power consumption	100 to 240 VAC: 12 VA 24 VAC/VDC: 8.5 VA (24 VAC)/5.5 W (24 VDC)	
Sensor input	Any of the following can be selected. Thermocouple: K, J, T, E, L, U, N, R, S, B, W, or PL II Platinum resistance thermometer: Pt100 or JPt100 Current input: 4 to 20 mA or 0 to 20 mA Voltage input: 1 to 5 V, 0 to 5 V, or 0 to 10 V	
Input impedance	Current input: 150 Ω max., Voltage input: 1 M Ω min. (Use a 1:1 connection when connecting the ES2-HB.)	
Control method	ON/OFF control or 2-PID control (with auto-tuning)	
Control output	Relay output	Output Unit (Install the Output Unit (sold separately).)
	Voltage output (for driving SSR)	
	Current output	
	Linear voltage output	
	Built-in SSR output	
	Relay output for position-proportional control	Relay output: Open and close: SPST-NO, 250 VAC, 1 A (including in-rush current), electrical life: 100,000 operations min. Potentiometer input: Must be between 100 Ω and 2.5 k Ω for maximum open position.
Auxiliary output	Number of outputs	2 or 3 max.
	Output specifications	Relay output: SPST-NO, 250 VAC, 3 A (resistive load), electrical life: 100,000 operations, minimum applicable load: 5 V, 10 mA
Event input	Number of outputs	2 or 4 (with an E53-AKB)
	External contact input specifications	Contact input: ON: 1 k Ω max., OFF: 100 k Ω min.
		Non-contact input: ON: Residual voltage: 1.5 V max., OFF: Leakage current: 0.1 mA max. Current flow: Approx. 7 mA per contact
Logic operations	Number of operations	8 max.
	Operations	<ul style="list-style-type: none"> Logic operation: Any of the following four patterns can be selected. The input status may be inverted. (A and B) or (C and D), (A or C) and (B or D), A or B or C or D, A and B and C and D (A, B, C, and D are four inputs.) Delay: ON delay or OFF delay for the results of the logic operation given above. Setting time: 0 to 9999 s or 0 to 9999 min Output inversion: Possible
	Output	One work bit per operation
	Work bit assignment	Any of The following can be assigned to up to eight work bits (logic operation results): Event input operations, auxiliary outputs, or control outputs.
Transfer outputs	Number of outputs	1 max. (Depends on model. Models with transfer output (F in model number)
	Output specifications	Current output: 4 to 20 mA DC, Load: 600 Ω max., Resolution at 4 to 20 mA: Approx. 10,000
RSP input	Number of inputs	1
	Signal type	Current input: 4 to 20 mA (input impedance: 150 Ω \pm 10%)
	Analog input scaling	Scaling of signal to engineering units (EU) -19,999 to 30,000 (display: 30,000 max.)
	Accuracy	(\pm 0.2% of FS) \pm 1 digit max.
	Input sampling period	60 ms
Setting method	Set digitally using keys on the front panel or by using the RSP input.	
Indication method	11-segment digital display and individual indicators (7-segments displays also possible) Character height: E5AN-H: PV: 15.8 mm, SV: 9.5 mm, MV: 6.8 mm; E5EN-H: PV: 11.8 mm, SV: 8.1 mm, MV: 5.8 mm Content of 3-level display: PV/SV/MV, PV/SV/Bank No., or soak time remain Number of digits: 5 for PV and SV, 4 for MV	
Bank switching	Supported (number of banks: 8) Local SP, alarm settings, PID sets (PID constants, MV upper limit, MV lower limit, etc.)	
Other functions	Manual output, heating/cooling control, loop burnout alarm, SP ramp, other alarm functions, heater burnout detection, 40% AT, 100% AT, MV limiter, input digital filter, self-tuning, temperature input shift, run/stop, protection functions, control output ON/OFF counter, extraction of square root, MV change rate limit, PV/SV status display, logic operations, automatic cooling coefficient adjustment	
Ambient operating temperature	-10 to 55°C (with no condensation or icing), for 3-year warranty: -10 to 50°C	
Ambient operating humidity	25% to 85%	
Storage temperature	-25 to 65°C (with no condensation or icing)	

Input Ranges

Thermocouple/Platinum Resistance Thermometer (Fully Universal Inputs)

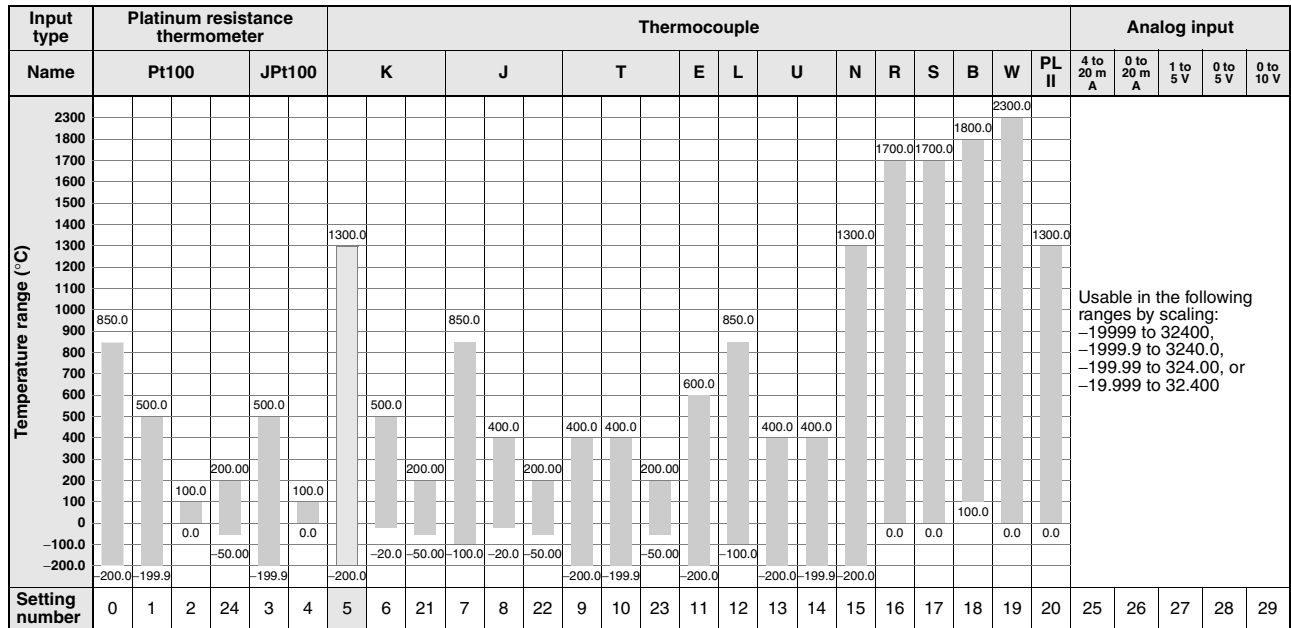

Shaded settings are the default settings.

The applicable standards for the input types are as follows:

K, J, T, E, N, R, S, B: JIS C 1602-1995, IEC 584-1

L: Fe-CuNi, DIN 43710-1985

U: Cu-CuNi, DIN 43710-1985

W: W5Re/W26Re, ASTM E988-1990

JPt100: JIS C 1604-1989, JIS C 1606-1989













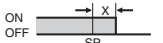

Pt100: JIS C 1604-1997, IEC 751

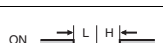
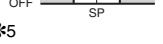
PL II: According to Platinel II electromotive force charts from BASF (previously Engelhard)

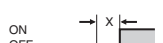
Alarm Outputs

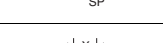
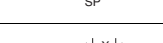
Each alarm can be independently set to one of the following 15 alarm types. The default is 2: *Upper limit*. Auxiliary outputs are allocated for alarms. ON delays and OFF delays (0 to 999 s) can also be specified.

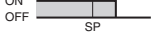
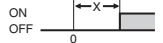
Note: For models with heater burnout, SSR failure, and heater overcurrent detection, alarm 1 will be an OR output of the alarm selected from the following alarm types and the alarms for heater burnout, SSR failure, and heater overcurrent. To output only a heater burnout alarm, SSR failure alarm, and heater overcurrent alarm for alarm 1, set the alarm type to 0 (i.e., no alarm function).

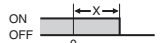
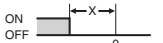
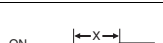
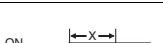
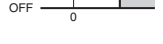
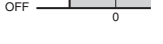
Set value	Alarm type	Alarm output operation	
		When X is positive	When X is negative
0	Alarm function OFF	Output OFF	
1 *1	Upper- and lower-limit	ON OFF 	*2
2	Upper limit	ON OFF 	ON OFF 
3	Lower limit	ON OFF 	ON OFF 
4 *1	Upper- and lower-limit range	ON OFF 	*3
5 *1	Upper- and lower-limit with standby sequence	ON OFF 	*4
6	Upper-limit with standby sequence	ON OFF 	ON OFF 
7	Lower-limit with standby sequence	ON OFF 	ON OFF 
8	Absolute-value upper-limit	ON OFF 	ON OFF 
9	Absolute-value lower-limit	ON OFF 	ON OFF 
10	Absolute-value upper-limit with standby sequence	ON OFF 	ON OFF 
11	Absolute-value lower-limit with standby sequence	ON OFF 	ON OFF 
12	LBA (for alarm 1 only)	---	
13	PV change rate alarm	---	
14	RSP absolute value upper limit *6	ON OFF 	ON OFF 
15	RSP absolute value lower limit *6	ON OFF 	ON OFF 

*1. With set values 1, 4 and 5, the upper and lower limit values can be set independently for each alarm type, and are expressed as "L" and "H."

*2. Set value: 1, Upper- and lower-limit alarm

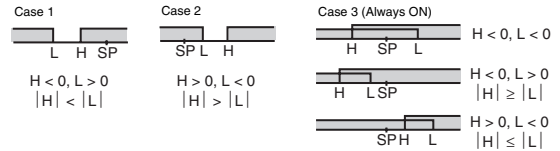

*3. Set value: 4, Upper- and lower-limit range

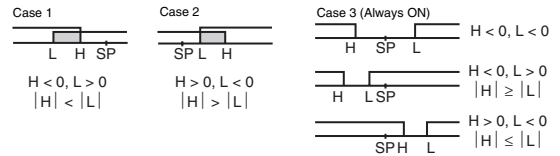

*4. Set value: 5, Upper- and lower-limit with standby sequence
For Upper- and Lower-Limit Alarm Described Above

• Case 1 and 2

Always OFF when the upper-limit and lower-limit hysteresis overlaps.

• Case 3: Always OFF

*5. Set value: 5, Upper- and lower-limit with standby sequence
Always OFF when the upper-limit and lower-limit hysteresis overlaps.

*6. Displayed when there is a remote SP input.

Characteristics

Indication accuracy	Thermocouple: ($\pm 0.1\%$ of indicated value or $\pm 1^\circ\text{C}$, whichever is greater) ± 1 digit max. *1 Platinum resistance thermometer: ($\pm 0.1\%$ of indicated value or $\pm 0.5^\circ\text{C}$, whichever is greater) ± 1 digit max. Analog input: $\pm 0.1\%$ FS ± 1 digit max. CT input: $\pm 5\%$ FS ± 1 digit max. Potentiometer input: $\pm 5\%$ FS ± 1 digit max.	
Transfer output accuracy	$\pm 0.3\%$ FS max.	
Influence of temperature *2	Thermocouple input (R, S, B, W, PL II): ($\pm 1\%$ of PV or $\pm 10^\circ\text{C}$, whichever is greater) ± 1 digit max. Other thermocouple input: ($\pm 1\%$ of PV or $\pm 4^\circ\text{C}$, whichever is greater) ± 1 digit max. *3	
Influence of voltage *2	Platinum resistance thermometer: ($\pm 1\%$ of PV or $\pm 2^\circ\text{C}$, whichever is greater) ± 1 digit max. Analog input: ($\pm 1\%$ FS) ± 1 digit max.	
Input sampling period	60 ms	
Hysteresis	Temperature input: 0.1 to 3240.0°C or °F (in units of 0.1°C or °F) Analog input: 0.01% to 99.99% FS (in units of 0.01% FS)	
Proportional band (P)	Temperature input: 0.1 to 3240.0°C or °F (in units of 0.1°C or °F) Analog input: 0.1% to 999.9% FS (in units of 0.1% FS)	
Integral time (I)	0.0 to 3240.0 s (in units of 0.1 s)	
Derivative time (D)	0.0 to 3240.0 s (in units of 0.1 s)	
Control period	0.5, 1 to 99 s (in units of 1 s)	
Manual reset value	0.0 to 100.0% (in units of 0.1%)	
Alarm setting range	-19999 to 32400 (decimal point position depends on input type)	
Affect of signal source resistance	Thermocouple: 0.1°C/ Ω max. (100 Ω max.) Platinum resistance thermometer: 0.1°C/ Ω max. (10 Ω max.)	
Insulation resistance	20 M Ω min. (at 500 VDC)	
Dielectric strength	2,300 VAC, 50 or 60 Hz for 1 min (between terminals with different charge)	
Vibration resistance	Malfunction	10 to 55 Hz, 20 m/s ² for 10 min each in X, Y, and Z directions
	Destruction	10 to 55 Hz, 0.75-mm single amplitude for 2 hrs each in X, Y, and Z directions
Shock resistance	Malfunction	100 m/s ² , 3 times each in X, Y, and Z directions
	Destruction	300 m/s ² , 3 times each in X, Y, and Z directions
Weight	E5AN-H	Controller: Approx. 310 g, Mounting Bracket: Approx. 100 g
	E5EN-H	Controller: Approx. 260 g, Mounting Bracket: Approx. 100 g
Degree of protection	Front panel: IP66, Rear case: IP20, Terminals: IP00	
Memory protection	Non-volatile memory (number of writes: 1,000,000 times)	
Setup Tool	CX-Thermo version 4.0 or higher	
Setup Tool port	Provided on the bottom of the E5AN-H and E5EN-H. An E58-CIFQ1 USB-Serial Conversion Cable is required to connect the computer to the E5AN-H and E5EN-H. Provided on the front of the E5AN-H and E5EN-H. An E58-CIFIR USB-infrared Conversion Cable is required to connect the computer to the E5AN-H or E5EN-H. *4	
Standards	Approved standards	UL 61010-1, CSA C22.2 No. 1010-1
	Conformed standards	EN 61010-1 (IEC 61010-1): Pollution level 2, overcurrent category II
EMC	EMI: Radiated Interference Electromagnetic Field Strength: Noise Terminal Voltage: EMS: ESD Immunity: Electromagnetic Field Immunity: Burst Noise Immunity: Conducted Disturbance Immunity: Surge Immunity: Power Frequency Magnetic Field Immunity: Voltage Dip/Interrupting Immunity:	EN 61326 EN 55011 Group 1, class A EN 55011 Group 1, class A EN 61326 EN 61000-4-2 EN 61000-4-3 EN 61000-4-4 EN 61000-4-6 EN 61000-4-5 EN 61000-4-8 EN 61000-4-11

*1. The indication accuracy of K thermocouples in the -200 to 1300°C range, T and N thermocouples at a temperature of -100°C max., and U and L thermocouples at any temperatures is $\pm 2^\circ\text{C} \pm 1$ digit max. The indication accuracy of the B thermocouple at a temperature of 400°C max. is not specified. The indication accuracy of B thermocouples in the 400 to 800°C range is $\pm 3^\circ\text{C}$ max. The indication accuracy of the R and S thermocouples at a temperature of 200°C max. is $\pm 3^\circ\text{C} \pm 1$ digit max. The indication accuracy of W thermocouples is $\pm 0.3\%$ of PV or $\pm 3^\circ\text{C}$, whichever is greater, ± 1 digit max.

The indication accuracy of PL II thermocouples is $\pm 0.3\%$ of PV or $\pm 2^\circ\text{C}$, whichever is greater, ± 1 digit max.

*2. Ambient temperature: -10°C to 23°C to 55°C, Voltage range: -15% to 10% of rated voltage

*3. K thermocouple at -100°C max.: $\pm 10^\circ\text{C}$ max.

*4. External communications (RS-232C, RS-485, or RS-422) and cable communications for the Setup Tool can be used at the same time.

USB-Serial Conversion Cable

Applicable OS	Windows 2000, XP, or Vista
Applicable software	CX-Thermo version 4.0 or higher
Applicable models	E5AN/E5EN/E5CN/E5CN-U/ E5AN-H/E5EN-H/E5CN-H
USB interface standard	Conforms to USB Specification 1.1.
DTE speed	38400 bps
Connector specifications	Computer: USB (type A plug) Temperature Controller: Setup Tool port (on bottom of Controller)
Power supply	Bus power (Supplied from USB host controller.)
Power supply voltage	5 VDC
Current consumption	70 mA
Ambient operating temperature	0 to 55°C (with no condensation or icing)
Ambient operating humidity	10% to 80%
Storage temperature	-20 to 60°C (with no condensation or icing)
Storage humidity	10% to 80%
Altitude	2,000 m max.
Weight	Approx. 100 g

Note: A driver must be installed in the personal computer. Refer to installation information in the operation manual for the Conversion Cable.

Communications Specifications

Transmission line connection method	RS-485, RS-422: Multipoint RS-232C: Point-to-point
Communications	RS-485 (two-wire, half duplex) RS-422 (four-wire, half duplex) or RS-232C
Synchronization method	Start-stop synchronization
Protocol	CompoWay/F, SYSWAY, or Modbus
Baud rate	1200, 2400, 4800, 9600, 19200, 38400, or 57600 bps
Transmission code	ASCII (CompoWay/F, SYSWAY) RTU (Modbus)
Data bit length *	7 or 8 bits
Stop bit length *	1 or 2 bits
Error detection	Vertical parity (none, even, odd) Frame check sequence (FCS) with SYSWAY Block check character (BCC) with CompoWay/F or CRC-16 Modbus
Flow control	None
Interface	RS-485, RS-422, or RS-232C
Retry function	None
Communications buffer	217 bytes
Communications response wait time	0 to 99 ms Default: 20 ms

* The baud rate, data bit length, stop bit length, and vertical parity can be individually set using the Communications Setting Level.

Current Transformer (Order Separately) Ratings

Dielectric strength	1,000 VAC for 1 min
Vibration resistance	50 Hz, 98 m/s ²
Weight	E54-CT1: Approx. 11.5 g, E54-CT3: Approx. 50 g
Accessories (E54-CT3 only)	Armatures (2) Plugs (2)

USB-Infrared Conversion Cable

Applicable OS	Windows 2000, XP, or Vista
Applicable software	CX-Thermo version 4.0 or higher
Applicable models	E5AN-H/E5EN-H
USB interface standard	Conforms to USB Specification 1.1.
DTE speed	38400 bps
Connector specifications	Computer: USB (type A plug) Temperature Controller: Infrared port (on front of Controller)
Power supply	Bus power (Supplied from USB host controller.)
Power supply voltage	5 VDC
Current consumption	80 mA
Ambient operating temperature	0 to 55°C (with no condensation or icing)
Ambient operating humidity	10% to 80%
Storage temperature	-20 to 60°C (with no condensation or icing)
Storage humidity	10% to 80%
Altitude	2,000 m max.
Weight	Approx. 130 g (with mounting adaptor)

Note: A driver must be installed in the personal computer. Refer to installation information in the operation manual for the Conversion Cable.

Heater Burnout Alarms, SSR Failure Alarms, and Heater Overcurrent Alarms

CT input (for heater current detection)	Models with detection for single-phase heaters: One input Models with detection for single-phase or three-phase heaters: Two inputs
Maximum heater current	50 A AC
Input current indication accuracy	±5% FS ±1 digit max.
Heater burnout alarm setting range *1	0.1 to 49.9 A (in units of 0.1 A) Minimum detection ON time: 100 ms
SSR failure alarm setting range *2	0.1 to 49.9 A (in units of 0.1 A) Minimum detection OFF time: 100 ms
Heater overcurrent alarm setting range *3	0.1 to 49.9 A (in units of 0.1 A) Minimum detection ON time: 100 ms

*1. For heater burnout alarms, the heater current will be measured when the control output is ON, and the output assigned to the alarm 1 function will turn ON if the heater current is lower than the set value (i.e., heater burnout detection current value).

*2. For SSR failure alarms, the heater current will be measured when the control output is OFF, and the output assigned to the alarm 1 function will turn ON if the heater current is higher than the set value (i.e., SSR failure detection current value).

*3. For heater overcurrent alarms, the heater current will be measured when the control output is ON, and the output assigned to the alarm 1 function will turn ON if the heater current is higher than the set value (i.e., heater overcurrent detection current value).

Electrical Life Expectancy Curve for Relays (Reference Values)

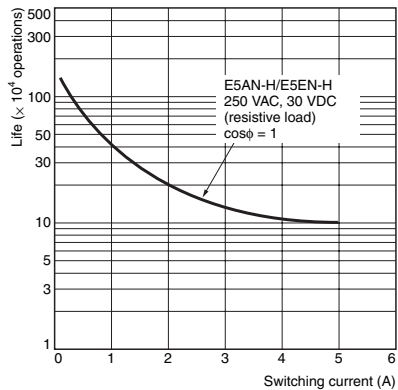

SSR Outputs (OUT1/OUT2) Ratings

- Rated load voltage: 75 to 250 VAC
- Rated load current: 1 A (resistive load)

Note: 1. The load current must be within the derating curve.
 2. There is no zero-cross function.

Derating Curve for SSR Outputs (Reference Values)

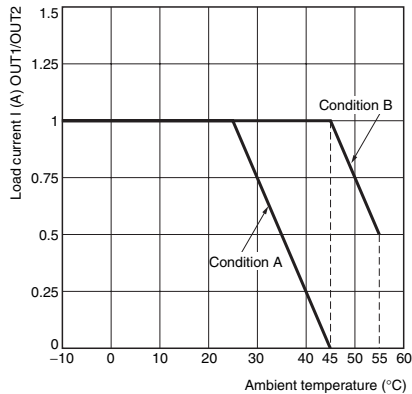

Condition A: SSR outputs 100% ON

Condition B: SSR outputs 50% ON with 2-s control cycle

External Connections

Control output 1 and control output 2 are functionally isolated from the internal circuits.

Controllers

The Temperature Controller is set for a K-type thermocouple (input type = 5) by default. An input error (5.ERR) will occur if the input type setting does not agree with the temperature sensor. Check the input type.

- 100 to 240 VAC
- 24 VAC/VDC (no polarity)

Option Units

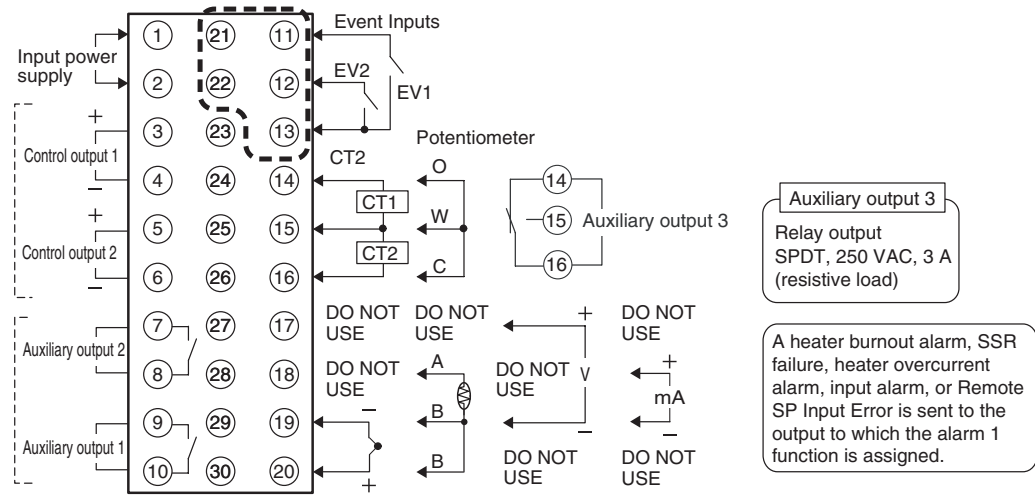
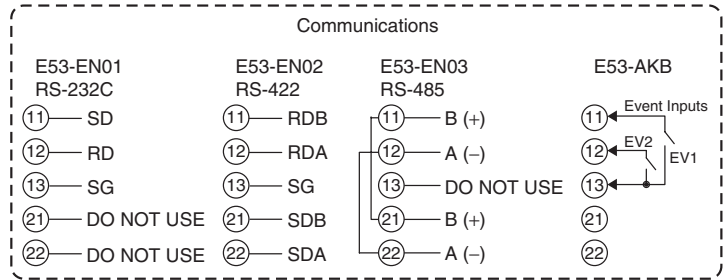

Control outputs 1, 2
Control Output Unit
Control outputs 1, 2
Refer to page 4
SSR Outputs
75 to 250 VAC, 1 A
(resistive load)
Models with Position-proportional Control
Relay output
250 VAC, 1 A
(including inrush current)

Auxiliary outputs 1, 2, 3
Relay output
SPST-NO,
250 VAC, 3 A
(resistive load)

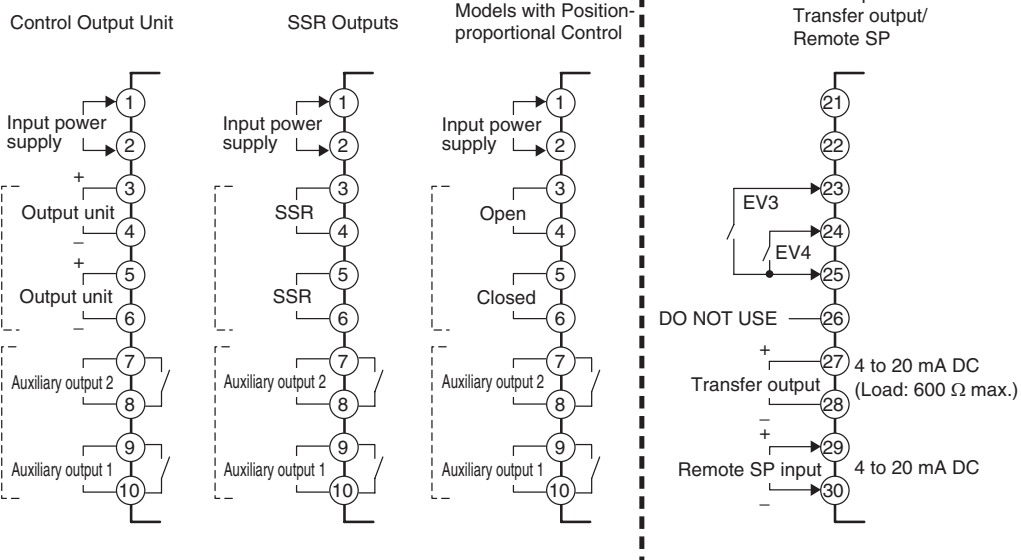

Note: Wire all voltage input terminals correctly. The Controller may fail if voltage input terminals are wired incorrectly.

Nomenclature

E5AN-H

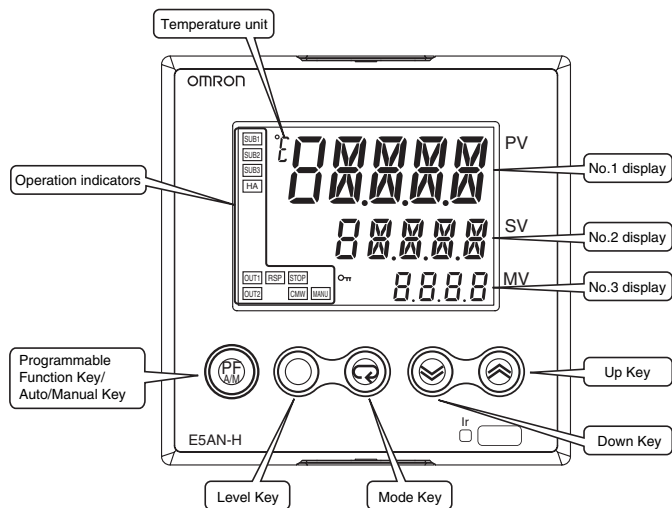

E5EN-H

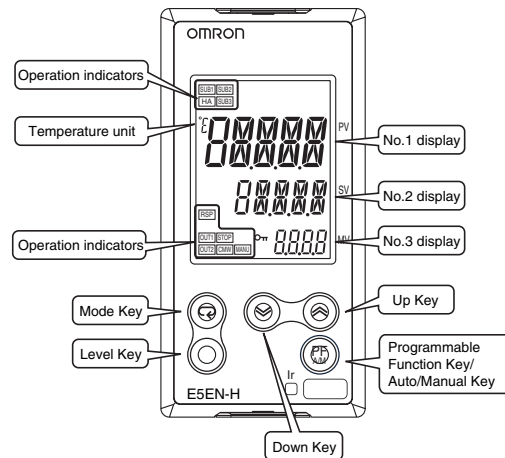

Dimensions

(Unit: mm)

E5AN-H

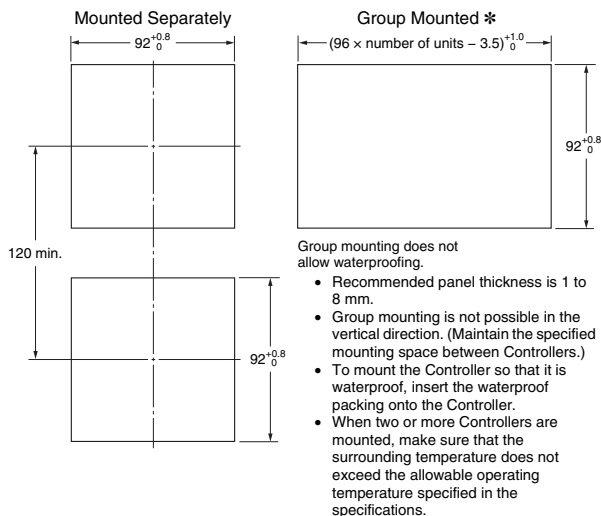
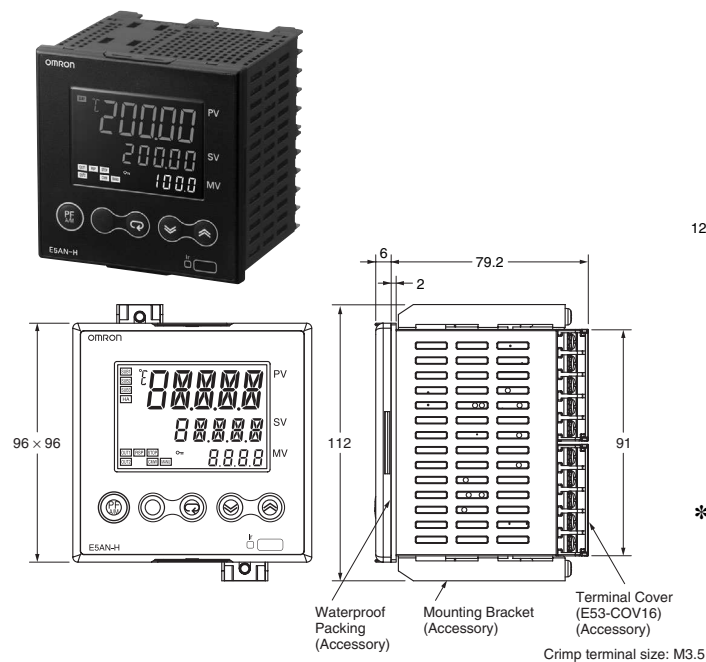

* Group mounting is not possible if an SSR output is used for control output 1 or 2 and the E53-C3N or E53-C3DN Output Unit is used. For these combinations, maintain the following mounting space between Controllers.

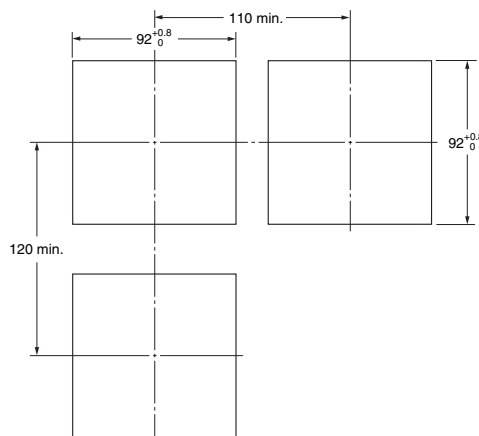

E5EN-H

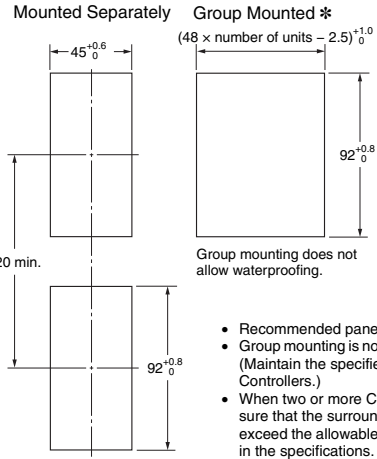
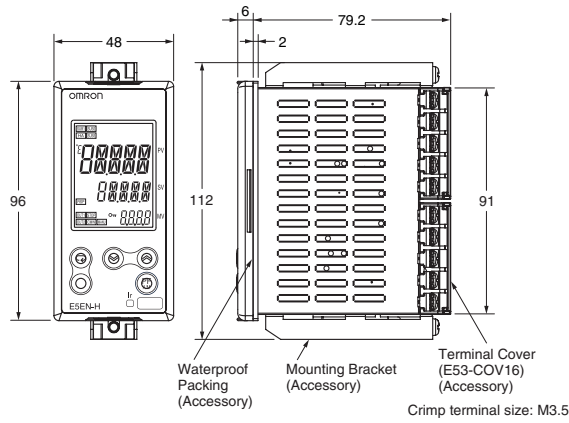

- Recommended panel thickness is 1 to 8 mm.
- Group mounting is not possible in the vertical direction. (Maintain the specified mounting space between Controllers.)
- When two or more Controllers are mounted, make sure that the surrounding temperature does not exceed the allowable operating temperature specified in the specifications.

* Group mounting is not possible if an SSR output is used for control output 1 or 2 and the E53-C3N or E53-C3DN Output Unit is used. For these combinations, maintain the following mounting space between Controllers.

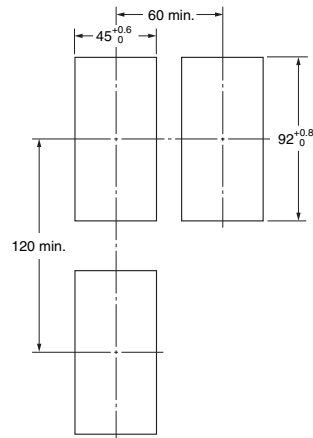

Accessories (Order Separately)

USB-Infrared Conversion Cable

E58-CIFIR

USB-Infrared Conversion Cable



Mounting Adapter

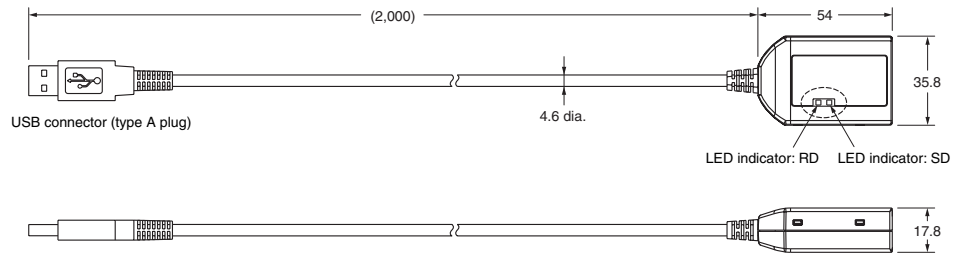

With Mounting Adapter Connected

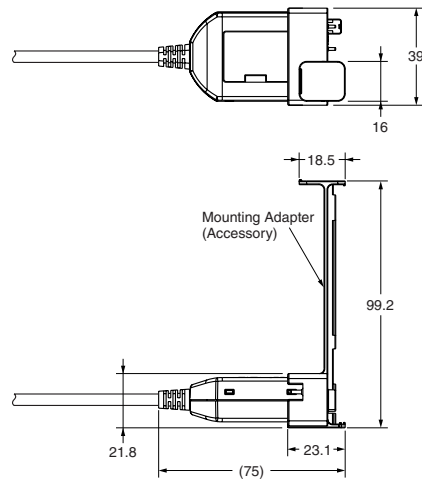

USB-Serial Conversion Cable

E58-CIFQ1

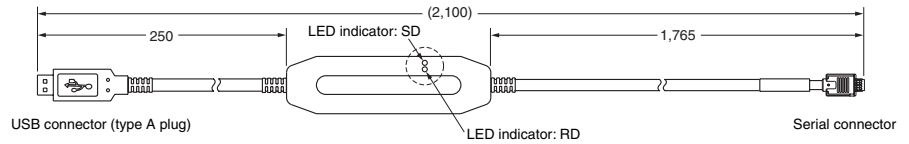
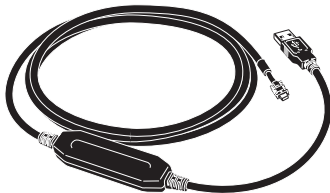

Terminal Covers

E53-COV16 (Six Covers provided.)

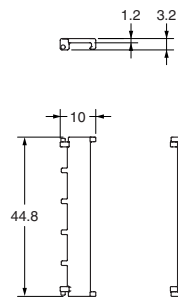

Waterproof Packing
Y92S-P4 (for DIN 96 × 96)

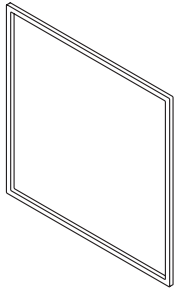

Y92S-P5 (for DIN 48 × 96)



Order the Waterproof Packing separately if it becomes lost or damaged.
The Waterproof Packing can be used to achieve an IP66 degree of protection.
(Deterioration, shrinking, or hardening of the waterproof packing may occur depending on the operating environment. Therefore, periodic replacement is recommended to ensure the level of waterproofing specified in IP66. The time for periodic replacement depends on the operating environment. Be sure to confirm this point at your site. Consider one year a rough standard. OMRON shall not be liable for the level of water resistance if the customer does not perform periodic replacement.)
The Waterproof Packing does not need to be attached if a waterproof structure is not required.

Current Transformers

E54-CT1

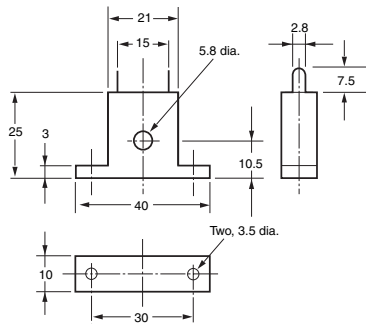

E54-CT1
Thru-current (Io) vs. Output Voltage (Eo) (Reference Values)

Maximum continuous heater current: 50 A (50/60 Hz)
Number of windings: 400±2
Winding resistance: 18±2 Ω

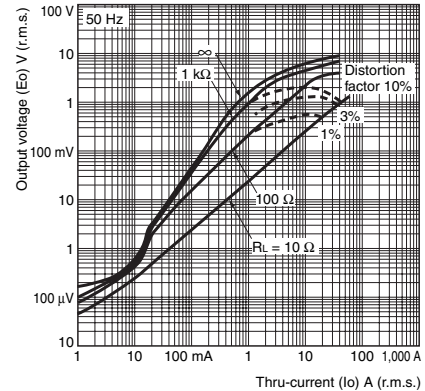

E54-CT3

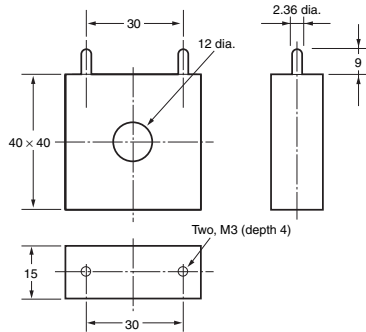

E54-CT3
Thru-current (Io) vs. Output Voltage (Eo) (Reference Values)

Maximum continuous heater current: 120 A (50/60 Hz)
(Maximum continuous heater current for an OMRON Temperature Controller is 50 A.)
Number of windings: 400±2
Winding resistance: 8±0.8 Ω

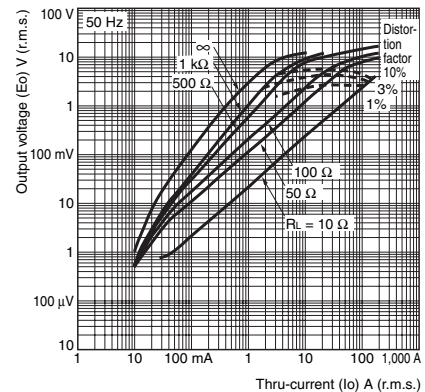

E54-CT3 Accessory

• Armature

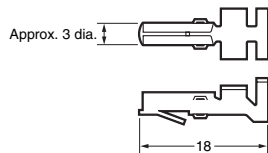

• Plug

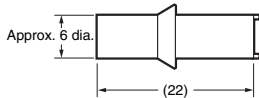

Connection Example

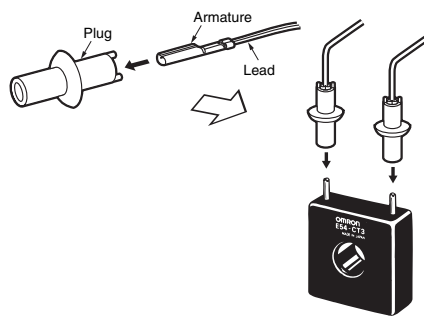

Read and Understand This Catalog

Please read and understand this catalog before purchasing the products. Please consult your OMRON representative if you have any questions or comments.

Warranty and Limitations of Liability

WARRANTY

OMRON's exclusive warranty is that the products are free from defects in materials and workmanship for a period of one year (or other period if specified) from date of sale by OMRON.

OMRON MAKES NO WARRANTY OR REPRESENTATION, EXPRESS OR IMPLIED, REGARDING NON-INFRINGEMENT, MERCHANTABILITY, OR FITNESS FOR PARTICULAR PURPOSE OF THE PRODUCTS. ANY BUYER OR USER ACKNOWLEDGES THAT THE BUYER OR USER ALONE HAS DETERMINED THAT THE PRODUCTS WILL SUITABLY MEET THE REQUIREMENTS OF THEIR INTENDED USE. OMRON DISCLAIMS ALL OTHER WARRANTIES, EXPRESS OR IMPLIED.

LIMITATIONS OF LIABILITY

OMRON SHALL NOT BE RESPONSIBLE FOR SPECIAL, INDIRECT, OR CONSEQUENTIAL DAMAGES, LOSS OF PROFITS OR COMMERCIAL LOSS IN ANY WAY CONNECTED WITH THE PRODUCTS, WHETHER SUCH CLAIM IS BASED ON CONTRACT, WARRANTY, NEGLIGENCE, OR STRICT LIABILITY.

In no event shall the responsibility of OMRON for any act exceed the individual price of the product on which liability is asserted.

IN NO EVENT SHALL OMRON BE RESPONSIBLE FOR WARRANTY, REPAIR, OR OTHER CLAIMS REGARDING THE PRODUCTS UNLESS OMRON'S ANALYSIS CONFIRMS THAT THE PRODUCTS WERE PROPERLY HANDLED, STORED, INSTALLED, AND MAINTAINED AND NOT SUBJECT TO CONTAMINATION, ABUSE, MISUSE, OR INAPPROPRIATE MODIFICATION OR REPAIR.

Application Considerations

SUITABILITY FOR USE

OMRON shall not be responsible for conformity with any standards, codes, or regulations that apply to the combination of products in the customer's application or use of the products.

At the customer's request, OMRON will provide applicable third party certification documents identifying ratings and limitations of use that apply to the products. This information by itself is not sufficient for a complete determination of the suitability of the products in combination with the end product, machine, system, or other application or use.

The following are some examples of applications for which particular attention must be given. This is not intended to be an exhaustive list of all possible uses of the products, nor is it intended to imply that the uses listed may be suitable for the products:

- Outdoor use, uses involving potential chemical contamination or electrical interference, or conditions or uses not described in this catalog.
- Nuclear energy control systems, combustion systems, railroad systems, aviation systems, medical equipment, amusement machines, vehicles, safety equipment, and installations subject to separate industry or government regulations.
- Systems, machines, and equipment that could present a risk to life or property.

Please know and observe all prohibitions of use applicable to the products.

NEVER USE THE PRODUCTS FOR AN APPLICATION INVOLVING SERIOUS RISK TO LIFE OR PROPERTY WITHOUT ENSURING THAT THE SYSTEM AS A WHOLE HAS BEEN DESIGNED TO ADDRESS THE RISKS, AND THAT THE OMRON PRODUCTS ARE PROPERLY RATED AND INSTALLED FOR THE INTENDED USE WITHIN THE OVERALL EQUIPMENT OR SYSTEM.

PROGRAMMABLE PRODUCTS

OMRON shall not be responsible for the user's programming of a programmable product, or any consequence thereof.

Disclaimers

CHANGE IN SPECIFICATIONS

Product specifications and accessories may be changed at any time based on improvements and other reasons.

It is our practice to change model numbers when published ratings or features are changed, or when significant construction changes are made. However, some specifications of the products may be changed without any notice. When in doubt, special model numbers may be assigned to fix or establish key specifications for your application on your request. Please consult with your OMRON representative at any time to confirm actual specifications of purchased products.

DIMENSIONS AND WEIGHTS

Dimensions and weights are nominal and are not to be used for manufacturing purposes, even when tolerances are shown.

PERFORMANCE DATA

Performance data given in this catalog is provided as a guide for the user in determining suitability and does not constitute a warranty. It may represent the result of OMRON's test conditions, and the users must correlate it to actual application requirements. Actual performance is subject to the OMRON Warranty and Limitations of Liability.

ERRORS AND OMISSIONS

The information in this document has been carefully checked and is believed to be accurate; however, no responsibility is assumed for clerical, typographical, or proofreading errors, or omissions.

2009.4

In the interest of product improvement, specifications are subject to change without notice.

OMRON Corporation
Industrial Automation Company

<http://www.ia.omron.com/>

(c)Copyright OMRON Corporation 2009 All Right Reserved.