

HIGH TEMPERATURE, EXTENDED LOAD LIFE, RADIAL LEADS, POLARIZED

FEATURES

- HIGH VOLTAGE (6.3 ~ 250V)
- LOW IMPEDANCE AT 100KHz
- LONG LIFE AT HIGH TEMPERATURE (UP TO 10,000 HOURS)

RoHS Compliant
includes all homogeneous materials

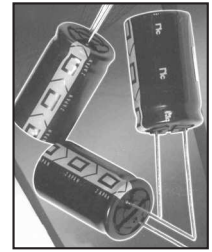

*See Part Number System for Details

CHARACTERISTICS

Rated Voltage Range		6.3 ~ 250VDC												
Capacitance Range		0.47 ~ 15,000 μ F												
Operating Temperature Range		-40°C ~ +105°C												
Capacitance Tolerance		\pm 20% (M)												
Maximum Leakage Current		0.01CV or 3 μ A whichever is greater after 2 minutes										0.04CV+100 μ A (After 1 minute)		
												0.02CV+25 μ A (After 5 minutes)		
Max. Tan δ at 120Hz/20°C	W.V. (Vdc)	6.3	10	16	25	35	50	63	100	160	200	250		
	S.V. (Vdc)	8	13	20	32	44	63	79	125	200	250	300		
	C \leq 1,000 μ F	0.22	0.19	0.16	0.14	0.12	0.10	0.09	0.08	0.12	0.12	0.12		
	C = 2,200 μ F	0.24	0.21	0.18	0.16	0.14	0.12	-	-	-	-	-		
	C = 3,300 μ F	0.26	0.23	0.20	0.18	0.16	-	-	-	-	-	-		
	C = 4,700 μ F	0.28	0.25	0.22	0.20	-	-	-	-	-	-	-		
	C = 6,800 μ F	0.32	0.29	0.26	-	-	-	-	-	-	-	-		
	C = 10,000 μ F	0.40	0.37	-	-	-	-	-	-	-	-	-		
Low Temperature Stability Impedance Ratio @ 120Hz	Z-20°C/Z+20°C	4	3	2	2	2	2	2	2	3	3	3		
	Z-40°C/Z+20°C	8	6	4	3	3	3	3	3	4	4	4		
Case Size & Voltage	Hours	Load Life Test @ 105°C and Rated Voltage												
D ϕ \leq 6.3mm, 6.3~10V	4000	Change in Characteristics	Δ Capacitance	Within \pm 25% of initial measured value (\pm 20% for 160 ~ 250Vdc parts)										
D ϕ \leq 6.3mm, 16~100V	5000			Δ Tan δ	Less than 200% of specified value									
D ϕ 8mm, 6.3~10V	6000				Δ LC	Less than specified value								
D ϕ 8mm, 16~100V	7000													
D ϕ 10mm, 6.3~10V	6000													
D ϕ 10mm, 16~100V	7000													
D ϕ 10mm, 160~250V	2000													
D ϕ \geq 12.5mm, 6.3~10V	8000													
D ϕ \geq 12.5mm, 16~100V	10000													
D ϕ \geq 12.5mm, 160~250V	2000													

PART NUMBER SYSTEM

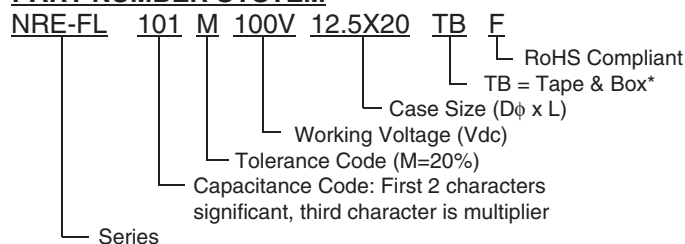

*see tape specification for details

PRECAUTIONS

Please review the notes on correct use, safety and precautions found on pages T10 & T11 of NIC's Electrolytic Capacitor catalog.
Also found at www.niccomp.com/precautions
If in doubt or uncertainty, please review your specific application - process details with NIC's technical support personnel: tpmg@niccomp.com



STANDARD PRODUCT AND CASE SIZE TABLE D ϕ x L (mm)

Cap. (μ F)	Code	Working Voltage (Vdc)										
		6.3	10	16	25	35	50	63	100	160	200	250
0.47	R47	-	-	-	-	-	5x11	-	5x11	-	-	-
1.0	1R0	-	-	-	-	-	5x11	-	5x11	-	-	-
2.2	2R2	-	-	-	-	-	5x11	-	5x11	-	-	-
3.3	3R3	-	-	-	-	-	5x11	-	5x11	-	-	-
4.7	4R7	-	-	-	-	-	5x11	-	5x11	-	-	-
10	100	-	-	-	-	-	5x11	5x11	6.3x11	-	-	-
22	220	-	-	-	-	-	5x11	6.3x11	8x11.5	10x20	10x20	10x20
33	330	-	-	-	5x11	5x11	6.3x11	6.3x11	10x12.5	12.5x20	12.5x25	12.5x25
47	470	-	-	5x11	5x11	6.3x11	6.3x11	8x11.5	10x16	12.5x25	12.5x25	16x25
68	680	-	-	-	-	-	-	-	-	12.5x25	16x25	16x31.5
100	101	5x11	5x11	6.3x11	6.3x11	8x11.5	8x11.5	10x12.5	12.5x20	16x25	16x31.5	16x35.5
150	151	-	-	-	-	-	-	-	-	16x31.5	16x35.5	-
220	221	6.3x11	6.3x11	8x11.5	8x11.5	10x12.5	10x16	10x20	16x25	18x35.5	18x35.5	-
330	331	6.3x11	8x11.5	8x11.5	10x12.5	10x16	10x20	12.5x20	16x25	-	-	-
470	471	8x11.5	8x11.5	10x12.5	10x16	10x20	12.5x20	12.5x25	-	-	-	-
1000	102	10x12.5	10x16	10x20	12.5x20	12.5x25	16x25	16x31.5	-	-	-	-
2200	222	12.5x20	12.5x20	12.5x25	16x25	16x31.5	18x35.5	-	-	-	-	-
3300	332	12.5x20	12.5x25	16x25	16x31.5	18x35.5	-	-	-	-	-	-
4700	472	16x25	16x25	16x31.5	18x35.5	-	-	-	-	-	-	-
6800	682	16x25	16x31.5	18x35.5	-	-	-	-	-	-	-	-
10000	103	16x31.5	18x35.5	-	-	-	-	-	-	-	-	-
15000	153	18x35.5	-	-	-	-	-	-	-	-	-	-

LEAD SPACING AND DIAMETER (mm)

Case Dia. (D ϕ)	5	6.3	8	10	12.5	16	18
Lead Dia. (D ϕ)	0.5	0.5	0.6	0.6	0.6	0.8	0.8
Lead Spacing (F)	2.0	2.5	3.5	5.0	5.0	7.5	7.5
Dim. α	0.5	0.5	0.5	0.5	0.5	0.5	0.5
Dim. β	L \leq 16mm: 1.5mm, L \geq 20mm: 2.0mm						

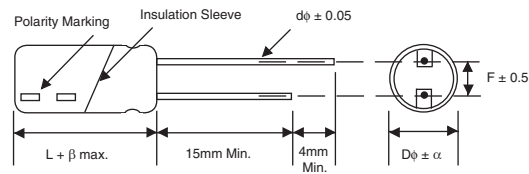

STANDARD PRODUCT, SPECIFICATIONS AND CASE SIZES D ϕ x L (mm)

Part Number	Cap. (μ F)	W.V. (Vdc)	Max. Tan δ	Max. LC 2 minutes (μ A)	Max. Impedance	Max. Ripple Current at 100KHz/105°C (mA rms)	Load Life Hours @ +105°C
					100KHz/20°C		
NRE-FL101M6.3V5x11F	100	6.3	0.22	6.3	0.90	150	4,000
NRE-FL221M6.3V6.3x11F	220		0.22	13.2	0.40	250	4,000
NRE-FL331M6.3V6.3x11F	330		0.22	18.9	0.40	250	4,000
NRE-FL471M6.3V8x11.5F	470		0.22	29.61	0.25	400	6000
NRE-FL102M6.3V10x12.5F	1000		0.22	63	0.16	580	6000
NRE-FL222M6.3V12.5x20F	2200		0.24	138.6	0.062	1300	8000
NRE-FL332M6.3V12.5x20F	3300		0.26	207.9	0.062	1300	8000
NRE-FL472M6.3V16x25F	4700		0.28	296.1	0.034	1850	8000
NRE-FL682M6.3V16x25F	6800		0.32	428.4	0.034	1850	8000
NRE-FL103M6.3V16x31.5F	10000		0.40	630	0.029	2000	8000
NRE-FL153M6.3V18x35.5F	15000		0.50	945	0.025	2200	8000
NRE-FL101M10V5x11F	100		10	0.19	10	0.90	150
NRE-FL221M10V6.3x11F	220	0.19		22	0.40	250	4,000
NRE-FL331M10V8x11.5F	330	0.19		33	0.25	400	6000
NRE-FL471M10V8x11.5F	470	0.19		47	0.25	400	6000
NRE-FL102M10V10x16F	1000	0.19		100	0.12	770	6000
NRE-FL222M10V12.5x20F	2200	0.21		220	0.062	1300	8000
NRE-FL332M10V12.5x20F	3300	0.23		330	0.048	1650	8000
NRE-FL472M10V16x25F	4700	0.25		470	0.034	1850	8000
NRE-FL682M10V16x31.5F	6800	0.29		680	0.029	2000	8000
NRE-FL103M10V18x35.5F	10000	0.37		1000	0.025	2200	8000



STANDARD PRODUCT, SPECIFICATIONS AND CASE SIZES D ϕ x L (mm)

Part Number	Cap. (μ F)	W.V. (Vdc)	Max. Tan δ	Max. LC 2 minutes (μ A)	Max. Impedance	Max. Ripple Current at 100KHz/105°C (mA rms)	Load Life Hours @ +105°C
					100KHz/20°C		
NRE-FL470M16V5x11F	47	16	0.16	7.52	0.90	150	5000
NRE-FL101M16V6.3x11F	100		0.16	16	0.40	250	5000
NRE-FL221M16V8x11.5F	220		0.16	35.2	0.25	400	7000
NRE-FL331M16V8x11.5F	330		0.16	52.8	0.25	400	7000
NRE-FL471M16V10x12.5F	470		0.16	75.2	0.16	580	7000
NRE-FL102M16V10x20F	1000		0.16	160	0.078	1050	7000
NRE-FL222M16V12.5x25F	2200		0.18	352	0.048	1650	10000
NRE-FL332M16V16x25F	3300		0.20	528	0.034	1850	10000
NRE-FL472M16V16x31.5F	4700		0.22	752	0.029	2000	10000
NRE-FL682M16V18x35.5F	6800		0.26	1088	0.025	2200	10000
NRE-FL330M25V5x11F	33	25	0.14	8.25	0.90	150	5000
NRE-FL470M25V5x11F	47		0.14	11.75	0.90	150	5000
NRE-FL101M25V6.3x11F	100		0.14	25	0.40	250	5000
NRE-FL221M25V8x11.5F	220		0.14	55	0.25	400	7000
NRE-FL331M25V10x12.5F	330		0.14	82.5	0.16	580	7000
NRE-FL471M25V10x16F	470		0.14	117.5	0.12	770	7000
NRE-FL102M25V12.5x20F	1000		0.14	250	0.062	1300	10000
NRE-FL222M25V16x25F	2200		0.16	550	0.034	1850	10000
NRE-FL332M25V16x31.5F	3300		0.18	825	0.029	2000	10000
NRE-FL472M25V18x35.5F	4700		0.20	1175	0.025	2200	10000
NRE-FL330M35V5x11F	33	35	0.12	11.55	0.90	150	5000
NRE-FL470M35V6.3x11F	47		0.12	16.45	0.40	250	5000
NRE-FL101M35V8x11.5F	100		0.12	35	0.25	400	7000
NRE-FL221M35V10x12.5F	220		0.12	77	0.16	580	7000
NRE-FL331M35V10x16F	330		0.12	115.5	0.12	770	7000
NRE-FL471M35V10x20F	470		0.12	164.5	0.078	1050	7000
NRE-FL102M35V12.5x25F	1000		0.12	350	0.048	1650	10000
NRE-FL222M35V16x31.5F	2200		0.14	770	0.029	2000	10000
NRE-FL332M35V18x35.5F	3300		0.16	1155	0.025	2200	10000
NRE-FLR47M50V5x11F	0.47		50	0.10	3	5.5	17
NRE-FL1R0M50V5x11F	1.0	0.10		3	4.0	30	5000
NRE-FL2R2M50V5x11F	2.2	0.10		3	2.5	43	5000
NRE-FL3R3M50V5x11F	3.3	0.10		3	2.2	53	5000
NRE-FL4R7M50V5x11F	4.7	0.10		3	1.9	88	5000
NRE-FL100M50V5x11F	10	0.10		5	1.5	100	5000
NRE-FL220M50V5x11F	22	0.10		11	0.90	150	5000
NRE-FL330M50V6.3x11F	33	0.10		16.5	0.40	250	5000
NRE-FL470M50V6.3x11F	47	0.10		23.5	0.40	250	5000
NRE-FL101M50V8x11.5F	100	0.10		50	0.25	400	7000
NRE-FL221M50V10x16F	220	0.10	110	0.12	770	7000	
NRE-FL331M50V10x20F	330	0.10	165	0.078	1050	7000	
NRE-FL471M50V12.5x20F	470	0.10	235	0.062	1300	10000	
NRE-FL102M50V16x25F	1000	0.10	500	0.034	1850	10000	
NRE-FL222M50V18x35.5F	2200	0.12	1100	0.025	2200	10000	
NRE-FL100M63V5x11F	10	63	0.09	6.3	2.3	87	5000
NRE-FL220M63V6.3x11F	22		0.09	13.86	1.3	140	5000
NRE-FL330M63V6.3x11F	33		0.09	20.79	1.2	140	5000
NRE-FL470M63V8x11.5F	47		0.09	29.61	0.63	210	7000
NRE-FL101M63V10x12.5F	100		0.09	63	0.43	300	7000
NRE-FL221M63V10x20F	220		0.09	138.6	0.21	520	7000
NRE-FL331M63V12.5x20F	330		0.09	207.9	0.16	660	10000
NRE-FL471M63V12.5x25F	470		0.09	296.1	0.12	750	10000
NRE-FL102M63V16x31.5F	1000		0.09	630	0.054	1390	10000

STANDARD PRODUCT, SPECIFICATIONS AND CASE SIZES D ϕ x L (mm)

Part Number	Cap. (μ F)	W.V. (Vdc)	Max. Tan δ	Max. LC 5 minutes (μ A)	Max. Impedance	Max. Ripple Current at 100KHz/105°C (mA rms)	Load Life Hours @ +105°C
					100KHz/20°C		
NRE-FLR47M100V5x11F	0.47	100	0.08	3.0	6.0	15	5000
NRE-FL1R0M100V5x11F	1.0		0.08	3.0	4.5	20	5000
NRE-FL2R2M100V5x11F	2.2		0.08	3.0	3.0	30	5000
NRE-FL3R3M100V5x11F	3.3		0.08	3.3	2.7	40	5000
NRE-FL4R7M100V5x11F	4.7		0.08	4.7	2.5	65	5000
NRE-FL100M100V6.3x11F	10		0.08	10	1.2	140	5000
NRE-FL220M100V8x11.5F	22		0.08	22	0.63	160	7000
NRE-FL330M100V10x12.5F	33		0.08	33	0.43	230	7000
NRE-FL470M100V10x16F	47		0.08	47	0.31	290	7000
NRE-FL101M100V12.5x20F	100		0.08	100	0.16	430	10000
NRE-FL221M100V16x25F	220		0.08	220	0.073	900	10000
NRE-FL331M100V16x25F	330		0.08	330	0.073	900	10000
NRE-FL220M160V10x20F	22	160	0.12	70.4	1.0	350	2000
NRE-FL330M160V12.5x20F	33		0.12	105.6	0.70	450	2000
NRE-FL470M160V12.5x25F	47		0.12	150.4	0.45	600	2000
NRE-FL680M160V12.5x25F	68		0.12	217.6	0.45	600	2000
NRE-FL101M160V16x25F	100		0.12	320	0.24	950	2000
NRE-FL151M160V16x31.5F	150		0.12	480	0.17	1200	2000
NRE-FL221M160V18x35.5F	220		0.12	704	0.14	1400	2000
NRE-FL220M200V10x20F	22	200	0.12	88	1.0	350	2000
NRE-FL330M200V12.5x25F	33		0.12	132	0.55	550	2000
NRE-FL470M200V12.5x25F	47		0.12	188	0.44	600	2000
NRE-FL680M200V16x25F	68		0.12	272	0.24	950	2000
NRE-FL101M200V16x31.5F	100		0.12	400	0.17	1200	2000
NRE-FL151M200V16x35.5F	150		0.12	600	0.16	1280	2000
NRE-FL221M200V18x35.5F	220		0.12	880	0.14	1400	2000
NRE-FL220M250V10x20F	22	250	0.12	110	1.4	300	2000
NRE-FL330M250V12.5x25F	33		0.12	165	0.70	450	2000
NRE-FL470M250V16x25F	47		0.12	235	0.31	850	2000
NRE-FL680M250V16x31.5F	68		0.12	340	0.22	1050	2000
NRE-FL101M250V16x35.5F	100		0.12	500	0.18	1200	2000

RIPPLE CURRENT FREQUENCY CORRECTION FACTOR

Frequency (Hz)	120	1K	10K	\leq 100K
0.47 ~ 10 μ F	0.42	0.60	0.80	1.00
22 ~ 33 μ F	0.55	0.75	0.90	1.00
47 ~ 330 μ F	0.70	0.85	0.95	1.00
470 ~ 1000 μ F	0.75	0.90	0.98	1.00
2200 ~ 15000 μ F	0.80	0.95	1.00	1.00

All 160 ~ 250V Parts					
Frequency (Hz)	60(50)	120	1K	10K	\leq 100K
Coefficient	0.40	0.50	0.75	0.90	1.00

Miniature Aluminum Electrolytic Capacitors Taping Specifications

STANDARD RADIAL TAPING (5mm LEAD SPACING, FORMED LEADS) TR, TB

Taping Dimensions (mm)

Case Dia. (D ϕ)	4	5	6.3	8
Case Size	4x5 4x7	5x5 5x7	5x11	6.3x5 6.3x7 6.3x11 8x11.5
d ϕ \pm 0.05	0.45	0.45	0.5	0.45
H \pm 0.75	17.5	17.5	18.5	17.5
F +0.8 ~ -0.2	5.0 -0.2 ~ +0.8			
P	12.7 \pm 1.0			
P ₀	12.7 \pm 0.2			
P ₁	3.85 \pm 0.5 (at end of tape)			
P ₂	6.35 \pm 1.0			
W	18.0 \pm 0.5			
W ₀	11.5 min.			
W ₁	9.0 \pm 0.5			
W ₂	0 ~ 2.5			
H ₀	16.0 \pm 0.5			
l	1.0 max.			
D ₀ ϕ	4.0 \pm 0.2			
Δ h	0 \pm 1.0 (at top of can)			
t	0.7 \pm 0.2 (not including lead)			

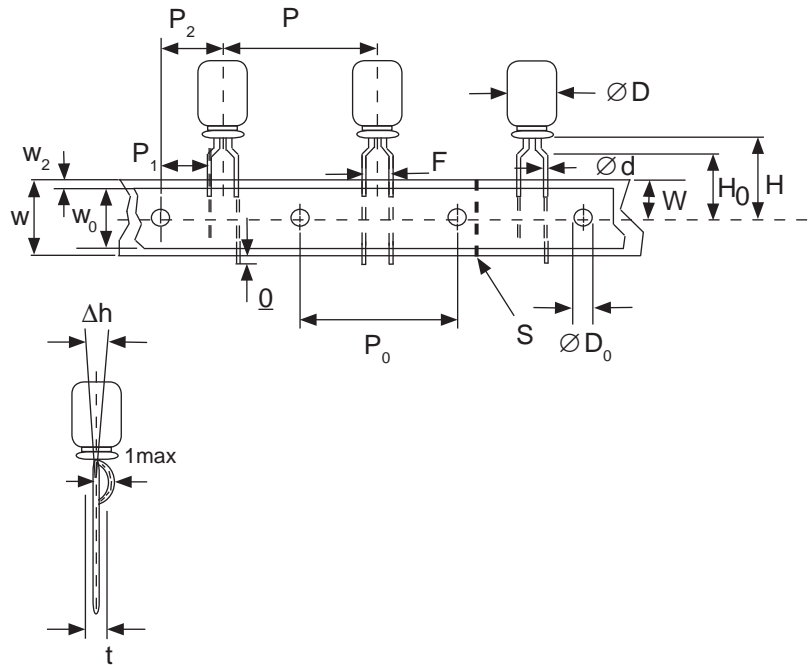

STANDARD RADIAL TAPING (5mm LEAD SPACING, STRAIGHT LEADS) TR, TB

Taping Dimensions (mm)

Case Dia. (D ϕ)	10	12.5
Case Size	All	All
d ϕ \pm 0.05	0.6	0.6
H \pm 0.75	19.0	19.0
F +0.8 ~ -0.2	5.0	5.0
P \pm 1.0	25.4*	
P ₀	12.7 \pm 0.2	
P ₁	3.85	
P ₂	6.35 \pm 1.0	
W	18.0 \pm 0.5	
W ₀	11.5 min	
W ₁	9.0 \pm 0.5	
W ₂	0 ~ 2.5	
H ₀	16.0 \pm 0.5	
l	1.0 max.	
D ₀ ϕ	4.0 \pm 0.2	
Δ h	0 \pm 1.0 (at top of can)	
t	0.7 \pm 0.2 (not including lead)	
*Optional Taping Specifications		
10mm diameter available with P dim. = 12.7mm (P/N Suffix: TB12.7MMP)		
12.5mm diameter available with P dim. = 15mm, P ₁ = 5.0mm, P ₀ = 15.0mm & P ₂ = 7.5mm (P/N Suffix: TB15MMP)		

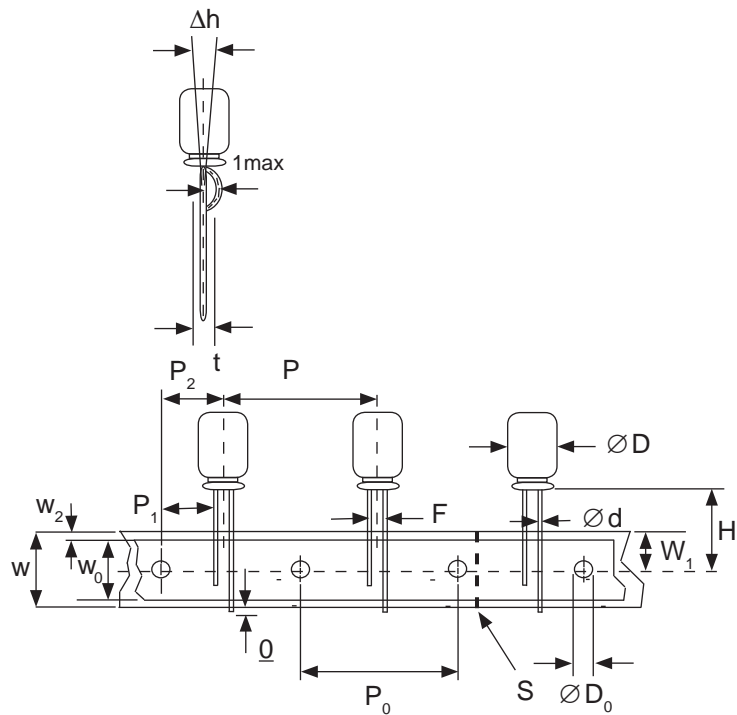

NOTE: ANODE (+) LEAD FEEDS OFF FIRST. FOR OPTION OF NEGATIVE (-) LEAD FIRST, SPECIFY "TRN" OR "TBN".



Miniature Aluminum Electrolytic Capacitors Taping Specifications

SPECIAL RADIAL TAPING (2.5mm LEAD SPACING, FORMED LEADS) TRF1, TBF1

Taping Dimensions (mm)

Case Dia. (D ϕ)	4		5	
Case Size Dim.	4x5 4x7	5x5 5x7	5x11	
d ϕ \pm 0.05	0.45	0.45	0.5	
H \pm 0.75	17.5	17.5	18.5	
H ₀ \pm 0.5	16.0	-	-	
F	2.5 -0.2 ~ +0.8			
P	12.7 \pm 1.0			
P ₀	12.7 \pm 0.2			
P ₁	5.1 \pm 0.5			
P ₂	6.35 \pm 1.0			
W	18.0 \pm 0.5			
W ₀	11.5 min.			
W ₁	9.0 \pm 0.5			
W ₂	0 ~ 1.5			
l	1.0 max.			
D ₀ ϕ	4.0 \pm 0.2			
Δ h	0 \pm 1.0			
t	0.7 \pm 0.2			

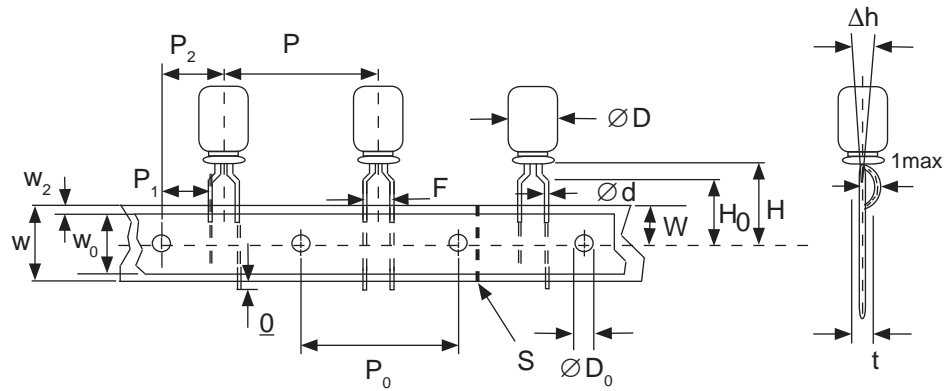

SPECIAL STRAIGHT LEAD TAPING TRST, TBST

Taping Dimensions (mm)

Case Dia. (D ϕ)	4			5			6.3		8	
Case Size Dim.	4x5 4x7	5x5 5x7	5x11		6.3x5 6.3x7	6.3x11		8x11.5		
d ϕ \pm 0.05	0.45	0.45	0.5		0.45	0.5		0.6		
H \pm 0.75	17.5	17.5	18.5		17.5	18.5		20.0		
F +0.8 ~ -0.2	2.0*	2.0	2.0		2.5	2.5		3.5		
P \pm 1.0	12.7 \pm 0.2									
P ₀	12.7 \pm 0.2									
P ₁	5.1	5.1	5.1	5.1	5.1	5.1	5.1	4.6		
P ₂	6.35 \pm 1.0									
W	18.0 \pm 0.5									
W ₀	11.5 min.									
W ₁	9.0 \pm 0.5									
W ₂	0 ~ 2.5									
H ₀	16.0 \pm 0.5									
l	1.0 max.									
D ₀ ϕ	4.0 \pm 0.2									
Δ h	0 \pm 1.0 (at top of can)									
t	0.7 \pm 0.2 (not including lead)									

* Parts with 4mm diameter are taped with a slight flare in the lead and a 2.0mm lead-space.

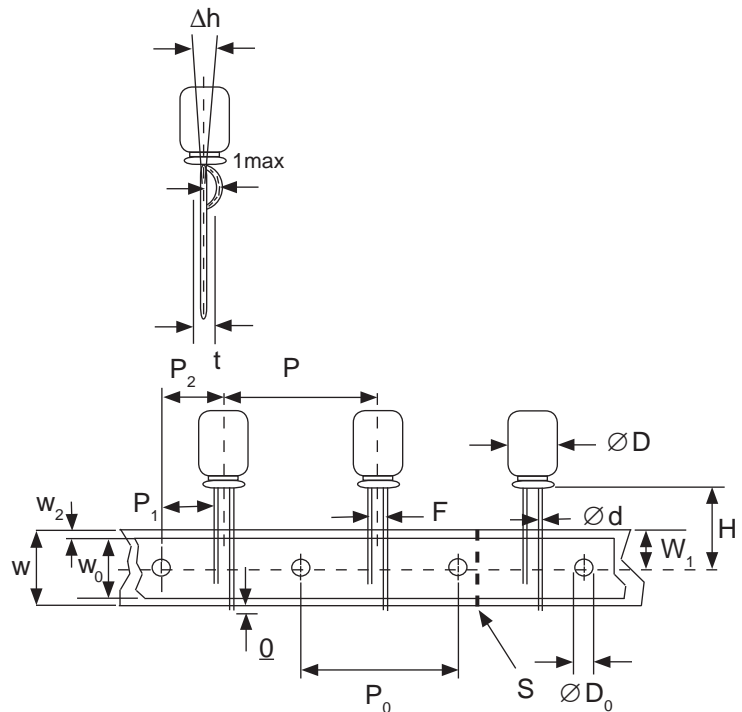

Miniature Aluminum Electrolytic Capacitors Taping Specifications

RADIAL TAPED PACKAGING

Ammo Box (Tape & Box) TB, TBF, TBST

Size of box and component quantity

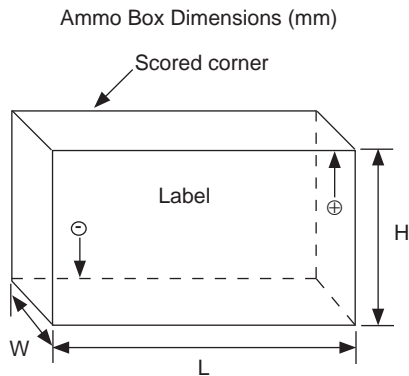

Case Dia (D ϕ) or Case Size	Q'ty per Box (pcs)	Dim. L	Dim. H	Dim. W
4x5, 4x7	2,000	331	175	43
5x5, 5x7	2,000	331	220	43
5x11	2,000	340	255	55
6.3x5, 6.3x7	2,000	331	280	43
6.3x11	2,000	331	280	48
8x11.5, 8x12.5	1,000	335	235	53
10x12.5*	500	335	190	53
10x16*	500	335	300	53
10x20*	500	335	300	55
12.x20*	500	335	300	55
12.5x25*	500	335	300	61

*Special Taping Consult Factory For Availability

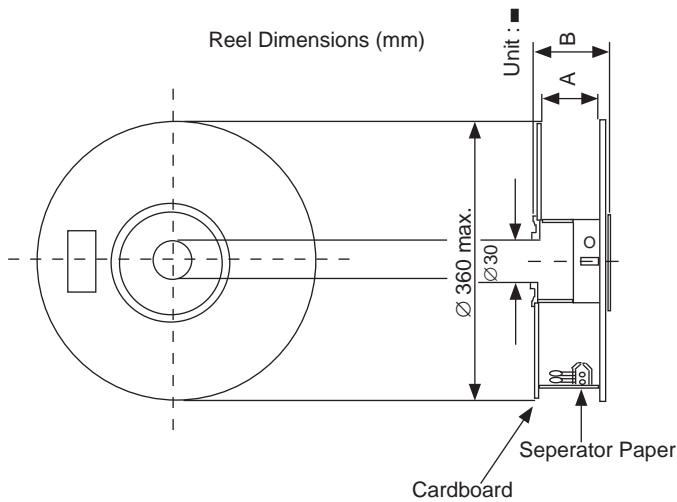

Reel Packages (Tape & Reel) TR, TRF1, TRST

Size of reel and component quantity

Case Dia (D ϕ) or Case Size	Q'ty per Box (pcs)	Dim. A	Dim. B
4 ϕ	1,800	42	52
5 ϕ	1,500	42	52
6.3 ϕ	1,000	42	52
8 ϕ	800	42	52
10x12.5*	600	42	52
10x16*	600	48	56
10x20*	600	52	60
12.x20*	250	52	60
12.5x25*	250	56	64

*Special Taping Consult Factory For Availability

