

GRM15XR71H681KA86#

"#" indicates a package specification code.



< List of part numbers with package codes >
GRM15XR71H681KA86D , GRM15XR71H681KA86J

Shape

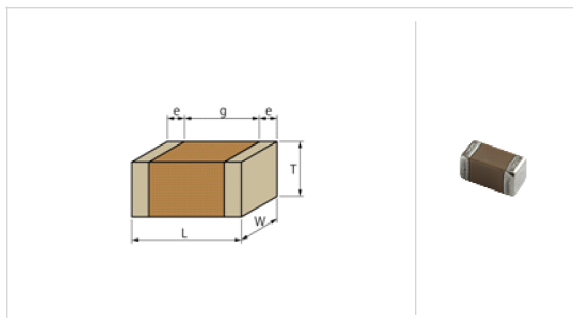

L size	1.0 ± 0.05mm
W size	0.5 ± 0.05mm
T size	0.25 ± 0.05mm
External terminal width e	0.1 to 0.3mm
Distance between external terminals g	0.4mm min.
Size code in mm(inch)	1005 (0402)

References

Packaging	Specifications	Minimum quantity
D	φ 180mm Paper taping	10000
J	φ 330mm Paper taping	50000

Mass (typ.)	
1 piece	0.90mg
φ 180mm Reel	82g

Specifications

Capacitance	680pF ± 10%
Rated voltage	50Vdc
Temperature characteristics (complied standard)	X7R(EIA)
Capacitance change rate	± 15.0%
Temperature range of temperature characteristics	-55 to 125°C
Operating temperature range	-55 to 125°C

⚠ Attention

- 1.This datasheet is downloaded from the website of Murata Manufacturing Co., Ltd. Therefore, it's specifications are subject to change or our products in it may be discontinued without advance notice. Please check with our sales representatives or product engineers before ordering.
- 2.This datasheet has only typical specifications because there is no space for detailed specifications. Therefore, please review our product specifications or consult the approval sheet for product specifications before ordering.

▪ Frequency characteristics (ESR, Impedance)

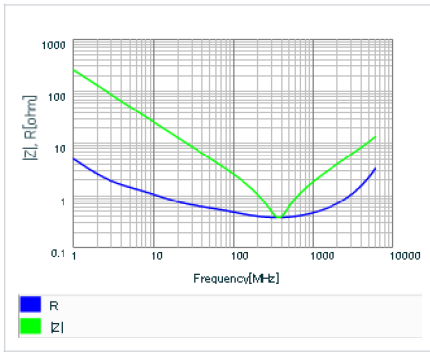

▪ S parameter (Smith chart S11)

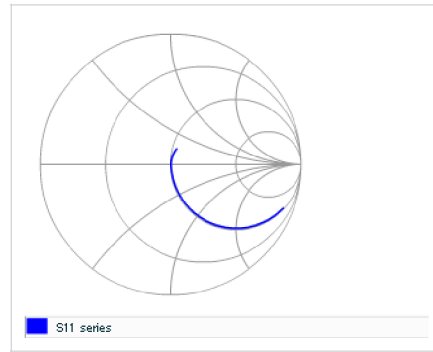

▪ DC bias characteristics

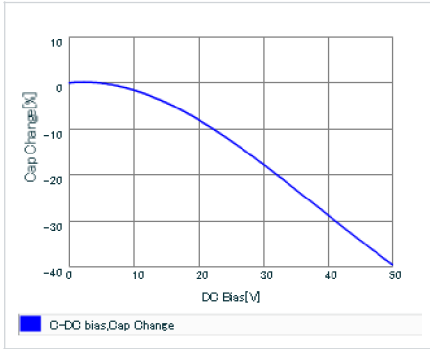

▪ AC voltage characteristics

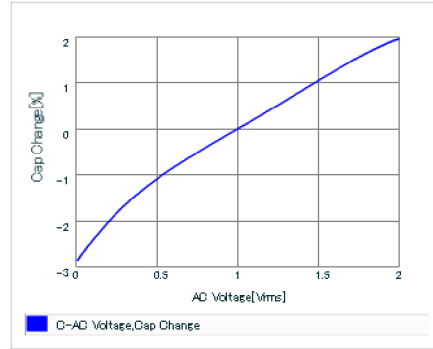

▪ Capacitance - temperature characteristics

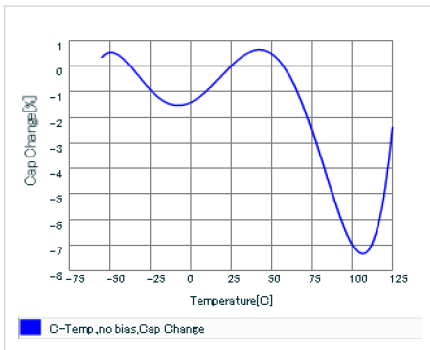

This PDF data has only typical specifications because there is no space for detailed specifications. Therefore, please review our product specifications or consult the approval sheet for product specifications before ordering.