

Micropower Voltage Reference Diodes

The LM285/LM385 series are micropower two-terminal bandgap voltage regulator diodes. Designed to operate over a wide current range of 10 μA to 20 mA, these devices feature exceptionally low dynamic impedance, low noise and stable operation over time and temperature. Tight voltage tolerances are achieved by on-chip trimming. The large dynamic operating range enables these devices to be used in applications with widely varying supplies with excellent regulation. Extremely low operating current make these devices ideal for micropower circuitry like portable instrumentation, regulators and other analog circuitry where extended battery life is required.

The LM285/LM385 series are packaged in a low cost TO-226AA plastic case and are available in two voltage versions of 1.235 and 2.500 V as denoted by the device suffix (see Ordering Information table). The LM285 is specified over a -40°C to $+85^{\circ}\text{C}$ temperature range while the LM385 is rated from 0°C to $+70^{\circ}\text{C}$.

The LM385 is also available in a surface mount plastic package in voltages of 1.235 and 2.500 V.

- Operating Current from 10 μA to 20 mA
- 1.0%, 1.5%, 2.0% and 3.0% Initial Tolerance Grades
- Low Temperature Coefficient
- 1.0 Ω Dynamic Impedance
- Surface Mount Package Available

LM285 LM385, B

MICROPOWER VOLTAGE REFERENCE DIODES

SEMICONDUCTOR TECHNICAL DATA

Z SUFFIX
PLASTIC PACKAGE
CASE 29

(Bottom View)

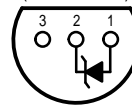

N.C.
Cathode
Anode

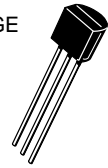

D SUFFIX
PLASTIC PACKAGE
CASE 751
(SO-8)

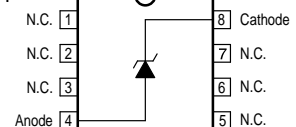
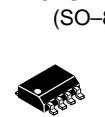

Representative Schematic Diagram

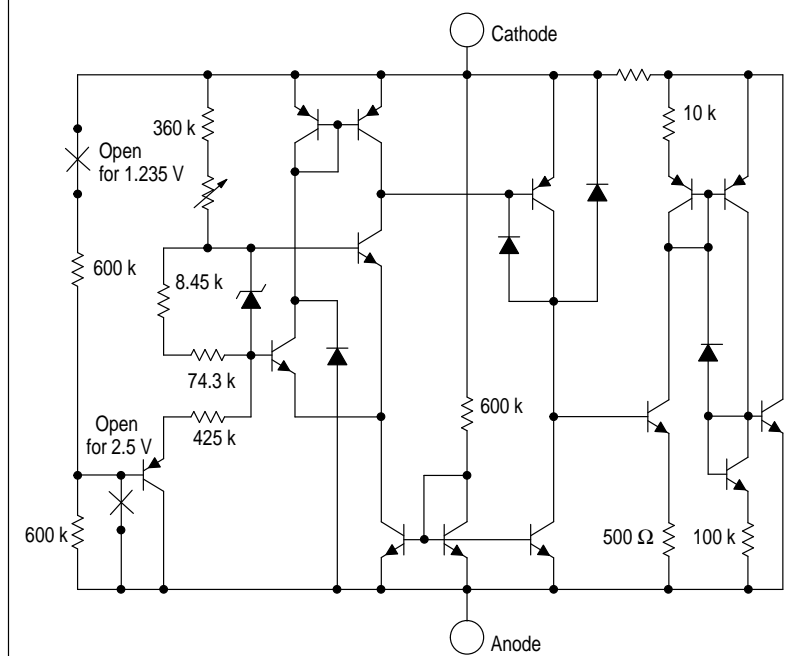

Standard Application

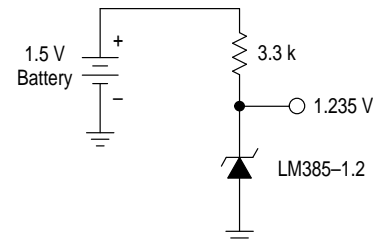

ORDERING INFORMATION

Device	Operating Temperature Range	Reverse Break-down Voltage	Tolerance
LM285D-1.2 LM285Z-1.2	$T_A = -40^{\circ}$ to $+85^{\circ}\text{C}$	1.235 V	$\pm 1.0\%$
LM285D-2.5 LM285Z-2.5		2.500 V	$\pm 1.5\%$
LM385BD-1.2 LM385BZ-1.2	$T_A = 0^{\circ}$ to $+70^{\circ}\text{C}$	1.235 V	$\pm 1.0\%$
LM385D-1.2 LM385Z-1.2		1.235 V	$\pm 2.0\%$
LM385BD-2.5 LM385BZ-2.5		2.500 V	$\pm 1.5\%$
LM385D-2.5 LM385Z-2.5		2.500 V	$\pm 3.0\%$

LM285 LM385, B

MAXIMUM RATINGS (T_A = 25°C, unless otherwise noted)

Rating	Symbol	Value	Unit
Reverse Current	I _R	30	mA
Forward Current	I _F	10	mA
Operating Ambient Temperature Range LM285 LM385	T _A	- 40 to + 85 0 to +70	°C
Operating Junction Temperature	T _J	+ 150	°C
Storage Temperature Range	T _{stg}	- 65 to + 150	°C

ELECTRICAL CHARACTERISTICS (T_A = 25°C, unless otherwise noted)

Characteristic	Symbol	LM285-1.2			LM385-1.2/LM385B-1.2			Unit
		Min	Typ	Max	Min	Typ	Max	
Reverse Breakdown Voltage (I _{Rmin} ≤ I _R ≤ 20 mA) LM285-1.2/LM385B-1.2 T _A = T _{low} to T _{high} (Note 1) LM385-1.2 T _A = T _{low} to T _{high} (Note 1)	V _{(BR)R}	1.223 1.200 – –	1.235 – – –	1.247 1.270 – –	1.223 1.210 1.205 1.192	1.235 – 1.235 –	1.247 1.260 1.260 1.273	V
Minimum Operating Current T _A = 25°C T _A = T _{low} to T _{high} (Note 1)	I _{Rmin}	– –	8.0 –	10 20	– –	8.0 –	15 20	μA
Reverse Breakdown Voltage Change with Current I _{Rmin} ≤ I _R ≤ 1.0 mA, T _A = +25°C T _A = T _{low} to T _{high} (Note 1) 1.0 mA ≤ I _R ≤ 20 mA, T _A = +25°C T _A = T _{low} to T _{high} (Note 1)	ΔV _{(BR)R}	– – – –	– – – –	1.0 1.5 10 20	– – – –	– – – –	1.0 1.5 20 25	mV
Reverse Dynamic Impedance I _R = 100 μA, T _A = +25°C	Z		0.6	–	–	0.6	–	W
Average Temperature Coefficient 10 μA ≤ I _R ≤ 20 mA, T _A = T _{low} to T _{high} (Note 1)	ΔV _{(BR)R} /ΔT	–	80	–	–	80	–	ppm/°C
Wideband Noise (RMS) I _R = 100 μA, 10 Hz ≤ f ≤ 10 kHz	n	–	60	–	–	60	–	μV
Long Term Stability I _R = 100 μA, T _A = +25°C ± 0.1°C	S	–	20	–	–	20	–	ppm/ kHR

LM285 LM385, B

ELECTRICAL CHARACTERISTICS ($T_A = 25^\circ\text{C}$, unless otherwise noted)

Characteristic	Symbol	LM285-2.5			LM385-2.5/LM385B-2.5			Unit
		Min	Typ	Max	Min	Typ	Max	
Reverse Breakdown Voltage ($I_{Rmin} \leq I_R \leq 20 \text{ mA}$) LM285-2.5/LM385B-2.5 $T_A = T_{low}$ to T_{high} (Note 1) LM385-2.5 $T_A = T_{low}$ to T_{high} (Note 1)	$V_{(BR)R}$	2.462 2.415 – –	2.5 – – –	2.538 2.585 – –	2.462 2.436 2.425 2.400	2.5 – 2.5 –	2.538 2.564 2.575 2.600	V
Minimum Operating Current $T_A = 25^\circ\text{C}$ $T_A = T_{low}$ to T_{high} (Note 1)	I_{Rmin}	– –	13 –	20 30	– –	13 –	20 30	μA
Reverse Breakdown Voltage Change with Current $I_{Rmin} \leq I_R \leq 1.0 \text{ mA}$, $T_A = +25^\circ\text{C}$ $T_A = T_{low}$ to T_{high} (Note 1) $1.0 \text{ mA} \leq I_R \leq 20 \text{ mA}$, $T_A = +25^\circ\text{C}$ $T_A = T_{low}$ to T_{high} (Note 1)	$\Delta V_{(BR)R}$	– – – –	– – – –	1.0 1.5 10 20	– – – –	– – – –	2.0 2.5 20 25	mV
Reverse Dynamic Impedance $I_R = 100 \mu\text{A}$, $T_A = +25^\circ\text{C}$	Z		0.6	–	–	0.6	–	W
Average Temperature Coefficient $20 \mu\text{A} \leq I_R \leq 20 \text{ mA}$, $T_A = T_{low}$ to T_{high} (Note 1)	$\Delta V_{(BR)R}/\Delta T$	–	80	–	–	80	–	ppm/ $^\circ\text{C}$
Wideband Noise (RMS) $I_R = 100 \mu\text{A}$, $10 \text{ Hz} \leq f \leq 10 \text{ kHz}$	n	–	120	–	–	120	–	μV
Long Term Stability $I_R = 100 \mu\text{A}$, $T_A = +25^\circ\text{C} \pm 0.1^\circ\text{C}$	S	–	20	–	–	20	–	ppm/ kHR

NOTES: 1. $T_{low} = -40^\circ\text{C}$ for LM285-1.2, LM285-2.5
 $= 0^\circ\text{C}$ for LM385-1.2, LM385B-1.2, LM385-2.5, LM385B-2.5

$T_{high} = +85^\circ\text{C}$ for LM285-1.2, LM285-2.5
 $= +70^\circ\text{C}$ for LM385-1.2, LM385B-1.2, LM385-2.5, LM385B-2.5

LM285 LM385, B

TYPICAL PERFORMANCE CURVES FOR LM285-1.2/385-1.2/385B-1.2

Figure 1. Reverse Characteristics

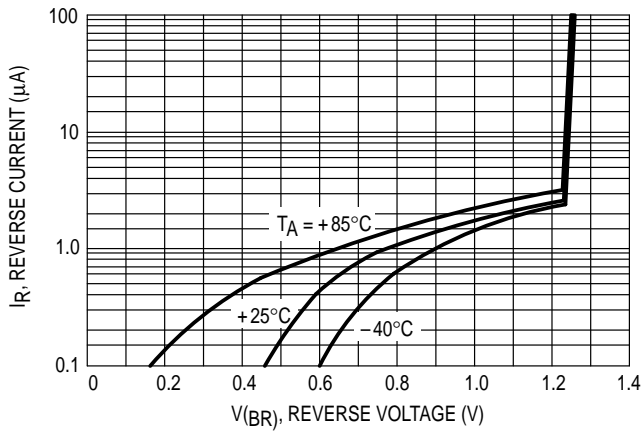

Figure 2. Reverse Characteristics

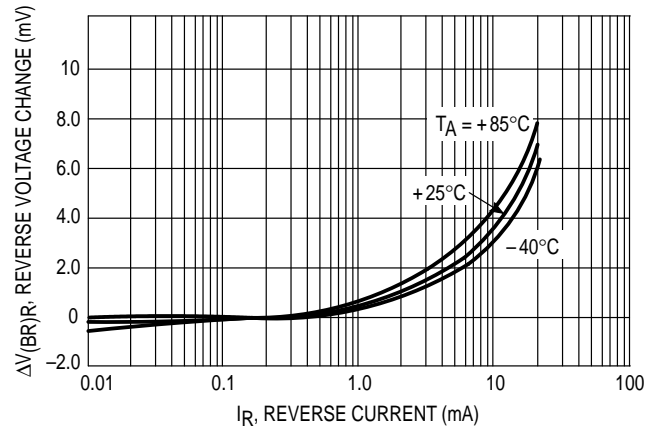

Figure 3. Forward Characteristics

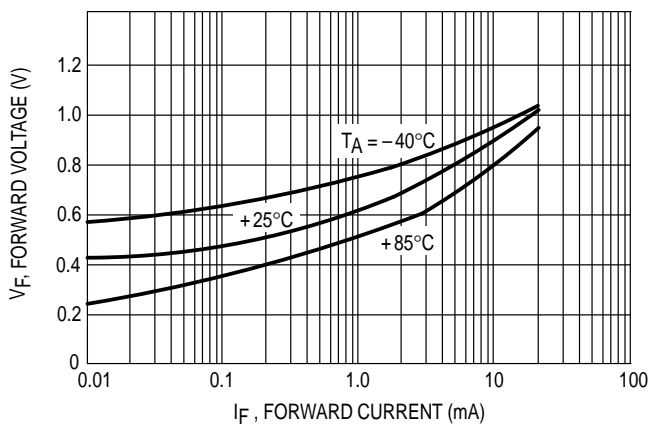

Figure 4. Temperature Drift

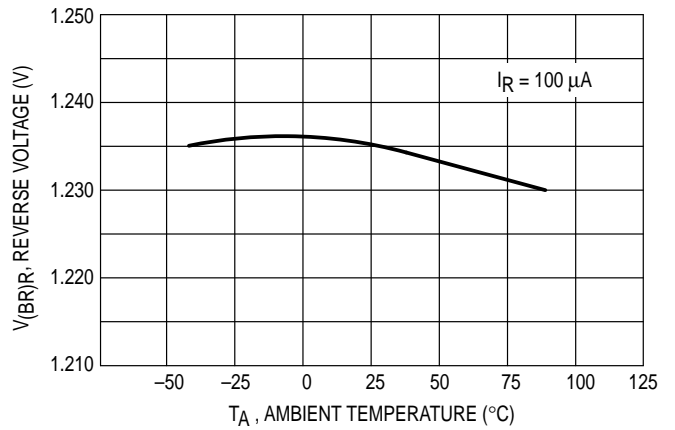

Figure 5. Noise Voltage

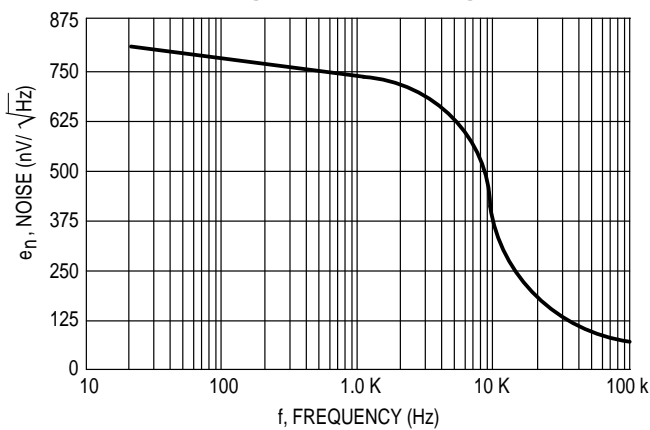
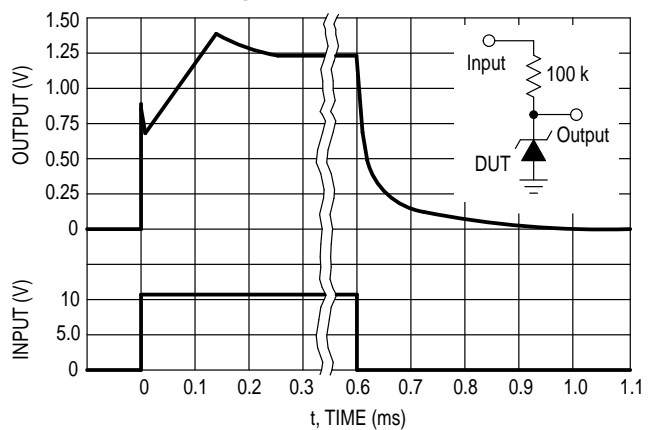

Figure 6. Response Time



LM285 LM385, B

TYPICAL PERFORMANCE CURVES FOR LM285-2.5/385-2.5/385B-2.5

Figure 7. Reverse Characteristics

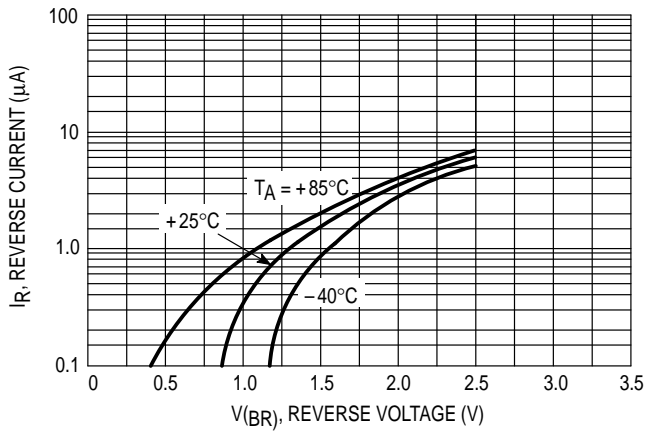

Figure 8. Reverse Characteristics

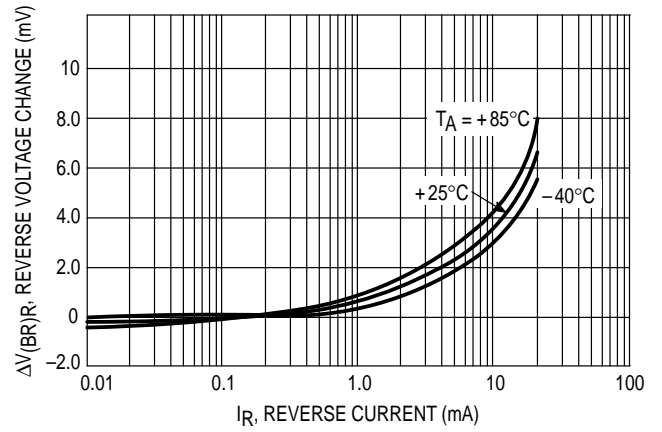

Figure 9. Forward Characteristics

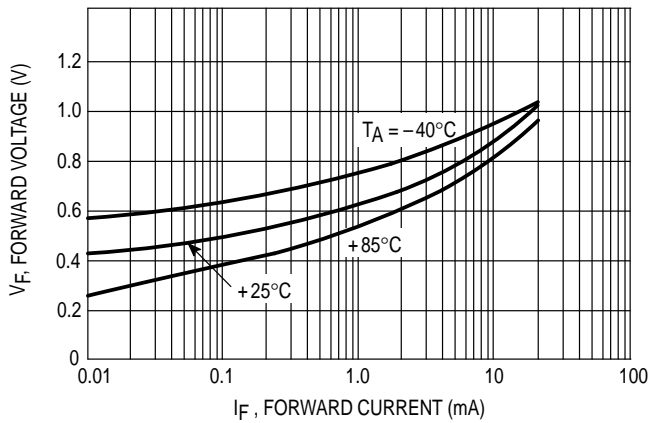

Figure 10. Temperature Drift

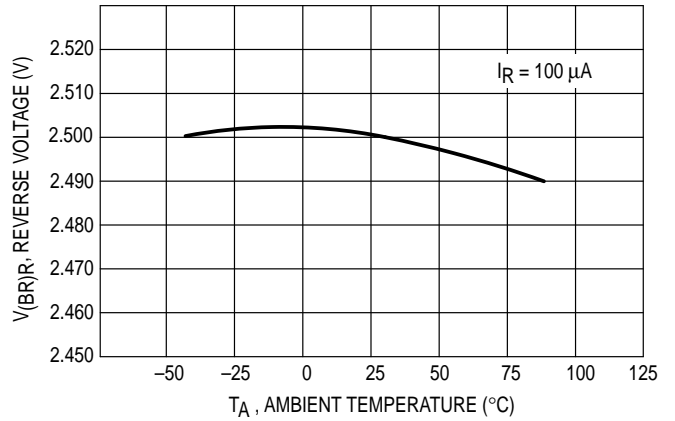

Figure 11. Noise Voltage

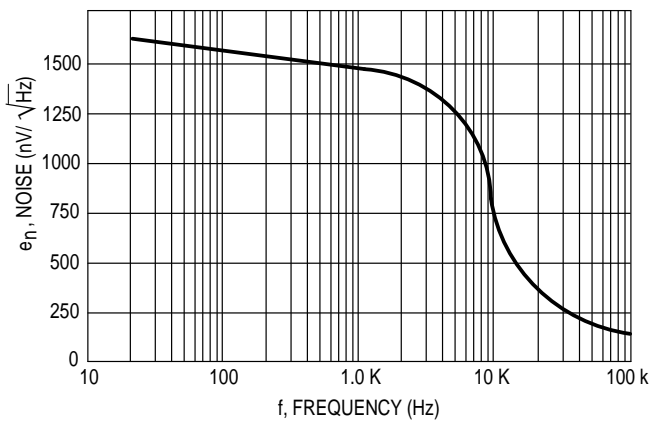
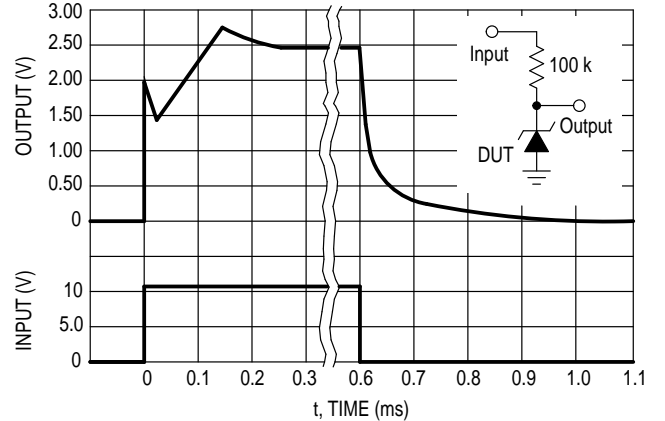

Figure 12. Response Time



LM285 LM385, B

OUTLINE DIMENSIONS

Z SUFFIX PLASTIC PACKAGE CASE 29-04 ISSUE AD

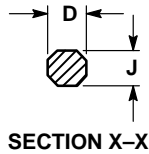
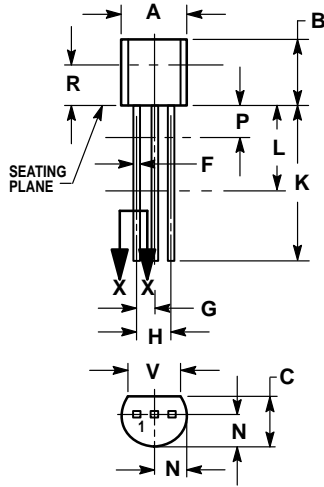

NOTES:

1. DIMENSIONING AND TOLERANCING PER ANSI Y14.5M, 1982.
2. CONTROLLING DIMENSION: INCH.
3. CONTOUR OF PACKAGE BEYOND DIMENSION R IS UNCONTROLLED.
4. DIMENSION F APPLIES BETWEEN P AND L. DIMENSION D AND J APPLY BETWEEN L AND K. MINIMUM LEAD DIMENSION IS UNCONTROLLED IN P AND BEYOND DIMENSION K MINIMUM.

DIM	INCHES		MILLIMETERS	
	MIN	MAX	MIN	MAX
A	0.175	0.205	4.45	5.20
B	0.170	0.210	4.32	5.33
C	0.125	0.165	3.18	4.19
D	0.016	0.022	0.41	0.55
F	0.016	0.019	0.41	0.48
G	0.045	0.055	1.15	1.39
H	0.095	0.105	2.42	2.66
J	0.015	0.020	0.39	0.50
K	0.500	—	12.70	—
L	0.250	—	6.35	—
N	0.080	0.105	2.04	2.66
P	—	0.100	—	2.54
R	0.115	—	2.93	—
V	0.135	—	3.43	—

D SUFFIX PLASTIC PACKAGE CASE 751-05 (SO-8) ISSUE N

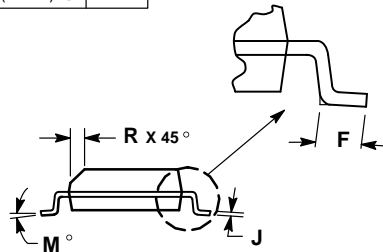
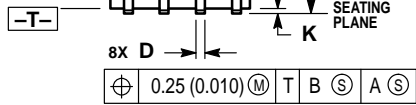
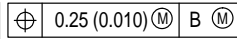
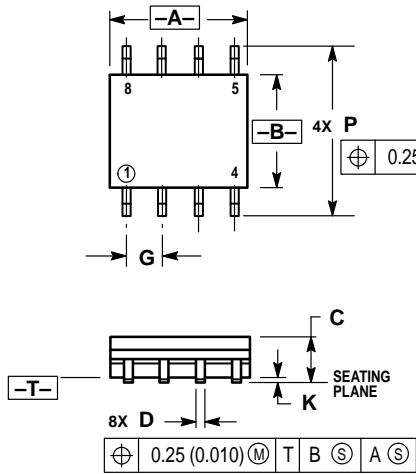

NOTES:

1. DIMENSIONING AND TOLERANCING PER ANSI Y14.5M, 1982.
2. CONTROLLING DIMENSION: MILLIMETER.
3. DIMENSIONS A AND B DO NOT INCLUDE MOLD PROTRUSION.
4. MAXIMUM MOLD PROTRUSION 0.15 (0.006) PER SIDE.
5. DIMENSION D DOES NOT INCLUDE DAMBAR PROTRUSION. ALLOWABLE DAMBAR PROTRUSION SHALL BE 0.127 (0.005) TOTAL IN EXCESS OF THE D DIMENSION AT MAXIMUM MATERIAL CONDITION.

DIM	MILLIMETERS		INCHES	
	MIN	MAX	MIN	MAX
A	4.80	5.00	0.189	0.196
B	3.80	4.00	0.150	0.157
C	1.35	1.75	0.054	0.068
D	0.35	0.49	0.014	0.019
F	0.40	1.25	0.016	0.049
G	1.27 BSC	—	0.050 BSC	—
J	0.18	0.25	0.007	0.009
K	0.10	0.25	0.004	0.009
M	0°	7°	0°	7°
P	5.80	6.20	0.229	0.244
R	0.25	0.50	0.010	0.019

LM285 LM385, B

Motorola reserves the right to make changes without further notice to any products herein. Motorola makes no warranty, representation or guarantee regarding the suitability of its products for any particular purpose, nor does Motorola assume any liability arising out of the application or use of any product or circuit, and specifically disclaims any and all liability, including without limitation consequential or incidental damages. "Typical" parameters which may be provided in Motorola data sheets and/or specifications can and do vary in different applications and actual performance may vary over time. All operating parameters, including "Typicals" must be validated for each customer application by customer's technical experts. Motorola does not convey any license under its patent rights nor the rights of others. Motorola products are not designed, intended, or authorized for use as components in systems intended for surgical implant into the body, or other applications intended to support or sustain life, or for any other application in which the failure of the Motorola product could create a situation where personal injury or death may occur. Should Buyer purchase or use Motorola products for any such unintended or unauthorized application, Buyer shall indemnify and hold Motorola and its officers, employees, subsidiaries, affiliates, and distributors harmless against all claims, costs, damages, and expenses, and reasonable attorney fees arising out of, directly or indirectly, any claim of personal injury or death associated with such unintended or unauthorized use, even if such claim alleges that Motorola was negligent regarding the design or manufacture of the part. Motorola and  are registered trademarks of Motorola, Inc. Motorola, Inc. is an Equal Opportunity/Affirmative Action Employer.

How to reach us:

USA/EUROPE/Locations Not Listed: Motorola Literature Distribution;
P.O. Box 20912; Phoenix, Arizona 85036. 1-800-441-2447 or 602-303-5454

MFAX: RMFAX0@email.sps.mot.com – TOUCHTONE 602-244-6609
INTERNET: <http://Design-NET.com>

JAPAN: Nippon Motorola Ltd.; Tatsumi-SPD-JLDC, 6F Seibu-Butsuryu-Center,
3-14-2 Tatsumi Koto-Ku, Tokyo 135, Japan. 03-81-3521-8315

ASIA/PACIFIC: Motorola Semiconductors H.K. Ltd.; 8B Tai Ping Industrial Park,
51 Ting Kok Road, Tai Po, N.T., Hong Kong. 852-26629298



LM285/D

