

High Power Limiters EL0037 2.7 GHz to 2.9 GHz

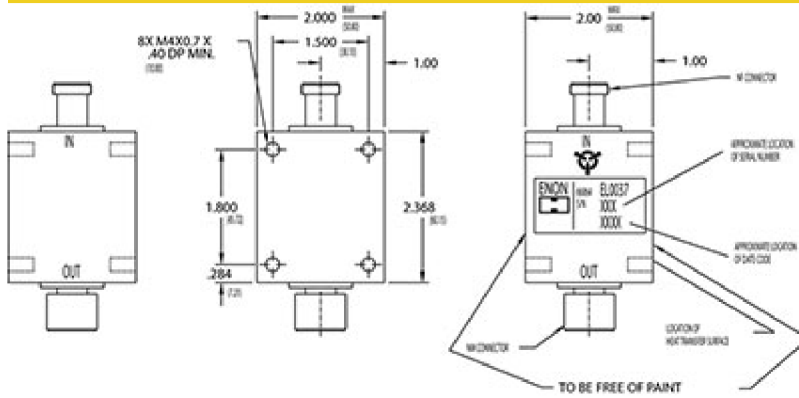

Power Input Specifications

RF Frequency	2.7 GHz to 2.9 GHz
Peak Power	1000 Watts (max)
Average Power	50 Watts (max)
Pulse Width	100 uSec

Microwave Specifications

Insertion Loss	0.5 dB
VSWR	1.3:1
Recovery Time	1 uS
Flat Leakage	+20 dBm

Mechanical Environmental Notes

Specifications subject to change without notice

Micronetics, Inc. | Hudson, NH | Tel: 1-603-883-2900 | www.Micronetics.com

MICRONETICS

