

tyco

Electronics

EJT Series

Compact RFI Filter
with IEC Connector
for Higher Frequency
Applications



corcom

General Information / Allgemeine Informationen

- | | |
|--|--|
| <ul style="list-style-type: none"> ■ New generation of power inlet filters ■ Flange mounted with optional outputs of 1/4" terminals or wire leads ■ RoHS compliant ■ Compact dimensions ■ Designed to attenuate noise up to 1 GHz ■ Designed to address the demand for more noise attenuation at higher frequencies e.g. computer systems, plasma TV ■ IEC 320/C14 input connector for 1-15 A versions ■ IEC 320/C20 input connector for 20 A versions | <ul style="list-style-type: none"> ■ <i>Neue Generation von Netzeingangsfiltern</i> ■ <i>Für Schraubmontage, wahlweise mit 6,3 mm FASTON oder Kabelanschlüssen auf der Ausgangsseite</i> ■ <i>RoHS konform</i> ■ <i>Kompakte Abmessungen</i> ■ <i>Geeignet zur Unterdrückung von Störungen bis zu 1 GHz</i> ■ <i>Speziell entwickelt zur Unterdrückung von Störungen im hohen Frequenzbereich z.B. für Computer-Systeme, Plasma-TV</i> ■ <i>IEC 320/C14 Stecker auf der Eingangsseite bei den 1-15 A Versionen</i> ■ <i>IEC 320/C20 Stecker auf der Eingangsseite bei den 20 A Versionen</i> |
|--|--|



Electrical Schematic / Elektrischer Schaltplan

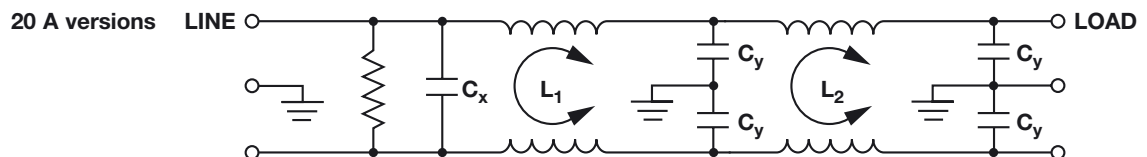
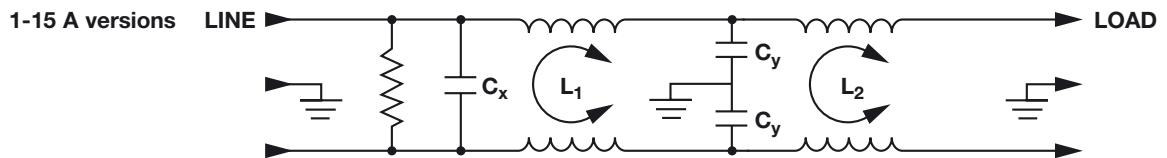

Specifications / Elektrische Eigenschaften

Maximum leakage current, each line-to-ground

@ 120 VAC 60 Hz: 0,22 mA (1-15 A versions); 0,20 mA (20 A versions)
@ 250 VAC 50 Hz: 0,38 mA (1-15 A versions); 0,40 mA (20 A versions)

Hipot rating (one minute):

line-to-ground 2250 VDC (1-15 A versions); 1500 VAC (20 A versions)
line-to-line 1450 VDC (all versions)

Operating frequency: 50/60 Hz

Rated voltage (max): 250 VAC

Ordering Information / Bestellinformationen

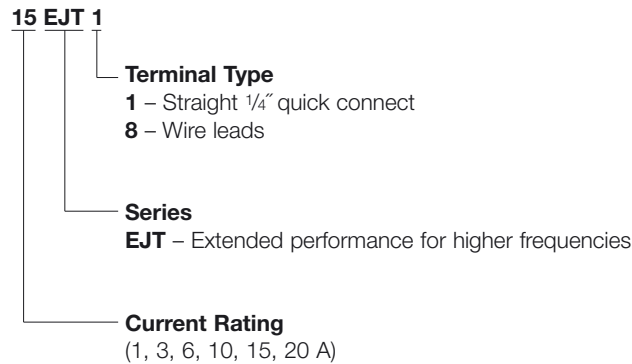

Type	Order no.	Max. Current UL / VDE	Inductance L ₁	Inductance L ₂	C _x	C _y
1EJT1	2-6609006-1	1 A / 1 A	2 x 3,720 mH	2 x 0,004 mH	0,1 µF	2 x (2,8 nF + 0,470 nF)
1EJT8	2-6609006-6	1 A / 1 A	2 x 3,720 mH	2 x 0,004 mH	0,1 µF	2 x (2,8 nF + 0,470 nF)
3EJT1	2-6609006-2	3 A / 3 A	2 x 1,990 mH	2 x 0,004 mH	0,1 µF	2 x (2,8 nF + 0,470 nF)
3EJT8	2-6609006-7	3 A / 3 A	2 x 1,990 mH	2 x 0,004 mH	0,1 µF	2 x (2,8 nF + 0,470 nF)
6EJT1	2-6609006-3	6 A / 6 A	2 x 0,930 mH	2 x 0,004 mH	0,1 µF	2 x (2,8 nF + 0,470 nF)
6EJT8	2-6609006-8	6 A / 6 A	2 x 0,930 mH	2 x 0,004 mH	0,1 µF	2 x (2,8 nF + 0,470 nF)
10EJT1	2-6609006-4	10 A / 10 A	2 x 0,360 mH	2 x 0,004 mH	0,1 µF	2 x (2,8 nF + 0,470 nF)
10EJT8	2-6609006-9	10 A / 10 A	2 x 0,360 mH	2 x 0,004 mH	0,1 µF	2 x (2,8 nF + 0,470 nF)
15EJT1	2-6609006-5	15 A / 10 A	2 x 0,198 mH	2 x 0,004 mH	0,1 µF	2 x (2,8 nF + 0,470 nF)
15EJT8	3-6609006-0	15 A / 10 A	2 x 0,198 mH	2 x 0,004 mH	0,1 µF	2 x (2,8 nF + 0,470 nF)
20EJT1	0-6609007-8	20 A / 16 A	2 x 0,087 mH	2 x 0,004 mH	0,1 µF	2 x (2,8 nF + 0,033 nF)
20EJT8	3-6609006-1	20 A / 16 A	2 x 0,087 mH	2 x 0,004 mH	0,1 µF	2 x (2,8 nF + 0,033 nF)

Case Styles / Gehäuseformen

EJT1 (1-15 A versions)

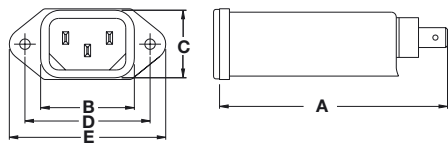

20 EJT1

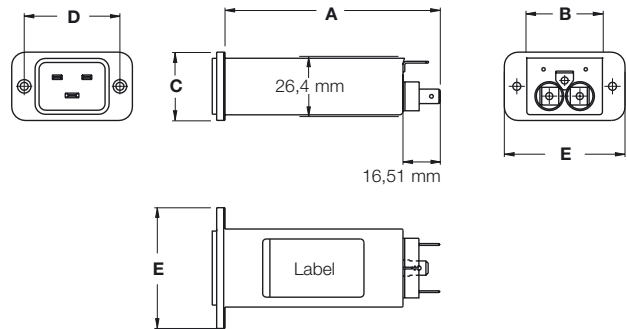

EJT8 (1-15 A versions)

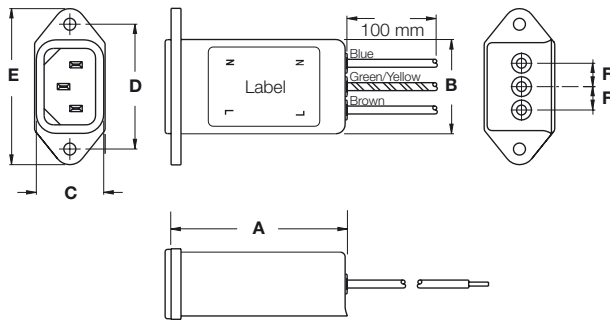

20 EJT8

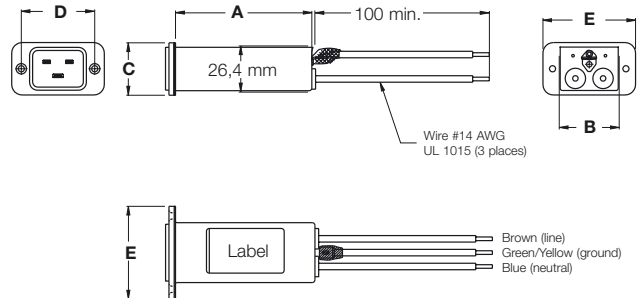

Recommended Panel Cutout / Gehäuseausschnitt

1-15 A version

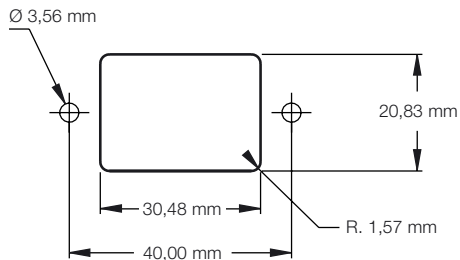

20 A version

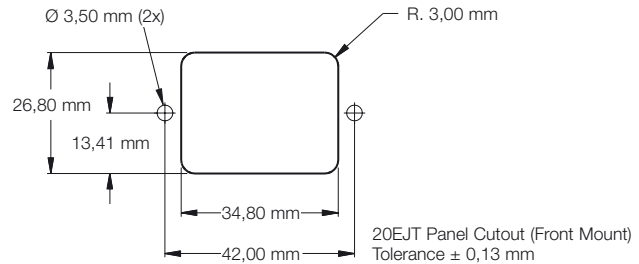

Dimensions and connections / Abmessungen und Anschlüsse

Type	A (max)	B (max)	C (max)	D (max)	E (max)	F (max)	connection
1EJT1, 3EJT1, 6EJT1, 10EJT1, 15EJT1	72,9	30,2	22,2	40,0	50,3	–	FASTON 6,3
20EJT1	96,5	34,3	30,0	42,0	53,0	–	FASTON 6,3
1EJT8, 3EJT8, 6EJT8, 10EJT8, 15EJT8	56,6	30,2	22,2	40,0	50,3	7,5	wire leads AWG 18; 100 mm
20EJT8	81,3	34,3	30,0	42,0	53,0	–	wire leads AWG 18; 100 mm

All dimensions in mm

Typ. Insertion Loss / Beispiel typischer Einfügungsdämpfung

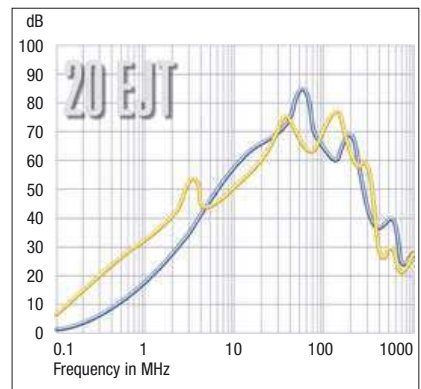
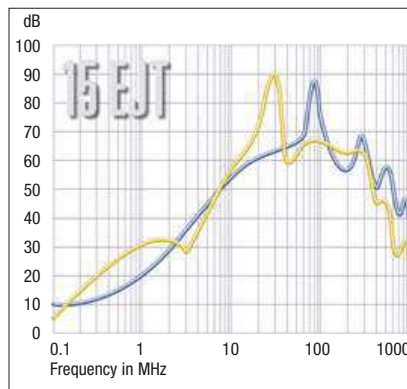
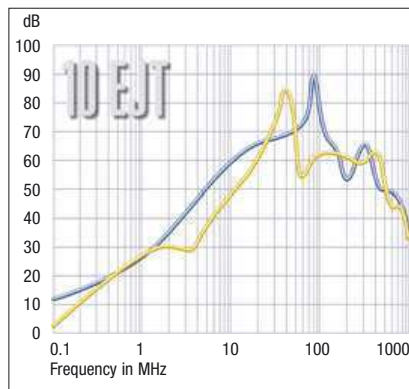
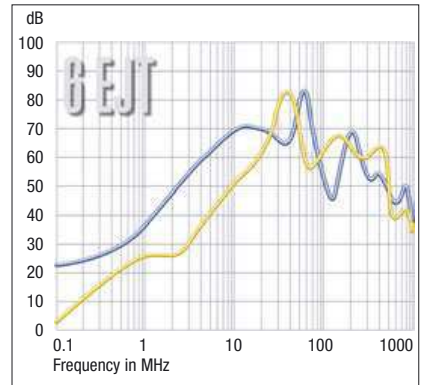
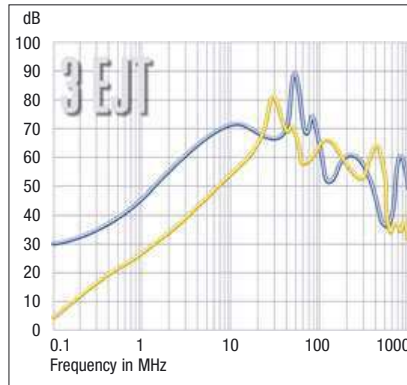
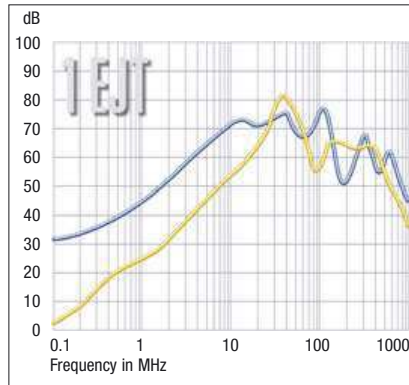

— sym.
— asym.

Measuring method: closed 50 Ω system

Austria – Vienna

Phone: +43-1-905-60-0
Fax: +43-1-905-60-1333

Product Information Center:

Phone: +43-1-905-60-1249
Fax: +43-1-905-60-1251

Belgium – Kessel-Lo

Phone: +32-16-352-300
Fax: +32-16-352-352

Bulgaria – Sofia

Phone: +359-2-971-2152
Fax: +359-2-971-2153

Czech Republic – Kurim

Phone: +420-5-41-162-111
Fax: +420-5-41-162-223

Product Information Center:

Phone: +420-5-41-162-113
Fax: +420-5-41-162-132

Denmark – Glostrup

Phone: +45-43-480-452
Fax: +45-43-441-414

Egypt – Cairo

Phone: +20-2-417-76-47
Fax: +20-2-419-23-34

Finland – Helsinki

Phone: +358-95-12-34-20
Fax: +358-95-12-34-250

France – Cergy-Pontoise Cedex

Phone: +33-1-3420-8888
Fax: +33-1-3420-8600

Product Information Center:

Phone: +33-1-3420-8686
Fax: +33-1-3420-8623

France Export Divisions –

Cergy-Pontoise Cedex
Phone: +33-1-3420-8866
Fax: +33-1-3420-8300

Germany – Bensheim**Tyco Electronics AMP GmbH**

Phone: +49-6251-133-0
Fax: +49-6251-133-1600

Product Information Center:

Phone: +49-6251-133-1999
Fax: +49-6251-133-1988

Germany – Langen**Tyco Electronics AMP GmbH**

Phone: +49-6103-709-0
Fax: +49-6103-709-1223

Germany – Niefern**Tyco Electronics pretema****GmbH & Co. KG**

Phone: +49-7233-69-0
Fax: +49-7233-69-100

Germany – Ottobrunn**Tyco Electronics Raychem GmbH**

Phone: +49-89-6089-0
Fax: +49-89-6096-345

Great Britain –

Stanmore Middlesex
Phone: +44-8706-080-208
Fax: +44-208-954-6234

Product Information Center:

Freephone GB: 0800-267-666
Phone: +44-208-420-8341
+44-208-420-8343
Fax: +44-208-420-8081

Greece – Athens

Phone: +30-210-9370-396/397
Fax: +30-210-9370-655

Hungary – Budapest

Phone: +36-1-289-1000
Fax: +36-1-289-1010

Product Information Center:

Phone: +36-1-289-1016
Fax: +36-1-289-1017

Ireland – Dublin

Phone: +353-1-820-3000
Fax: +353-1-820-9790

Israel – Yokneam

Phone: +972-4-959-0508
Fax: +972-4-959-0506

Italy – Collegno (Torino)

Phone: +39-011-4012-111
Fax: +39-011-4031116

Product Information Center:

Phone: +39-011-4012-360
Fax: +39-011-40287360

Lithuania – Vilnius

Phone: +370-5-2131-402
Fax: +370-5-2131-403

Netherlands – 's-Hertogenbosch

Phone: +31-73-6246-246
Fax: +31-73-6212-365

Product Information Center:

Phone: +31-73-6246-999
Fax: +31-73-6246-998

Norway – Nesbru

Phone: +47-66-77-88-86
Fax: +47-66-77-88-55

Poland – Warsaw

Phone: +48-22-4576-700
Fax: +48-22-4576-720

Product Information Center:

Phone: +48-22-4576-704
Fax: +48-22-4576-720

Romania – Bucharest

Phone: +40-21-311-3479 + 3596
Fax: +40-21-312-0574

Russia – Moscow

Phone: +7-095-926-55-06...09
Fax: +7-095-926-55-05

Russia – St. Petersburg

Phone: +7-812-718-8192
Fax: +7-812-718-8193

Slovenia – Ljubljana

Phone: +386-1561-3270
Fax: +386-1561-3240

South Africa – Port Elizabeth

Phone: +2741-503-4500
Fax: +2741-581-0440

Spain – Barcelona

Phone: +34-93-291-0330
Fax: +34-93-201-7879

Sweden – Upplands Väsby

Phone: +46-8-50-72-50-00
Fax: +46-8-50-72-50-01

Switzerland – Steinach

Phone: +41-71-447-0447
Fax: +41-71-447-0444

Turkey – Istanbul

Phone: +90-212-281-8181...3
+90-212-282-5130/5430
Fax: +90-212-281-8184

Ukraine – Kiev

Phone: +380-44-206-2265
Fax: +380-44-206-2264