

LM27961

Dual-Display White LED Driver with 3/2x Switched Capacitor Boost

General Description

The LM27961 is a charge-pump-based white-LED driver that is ideal for mobile phone display backlighting. It is intended to drive 4 LEDs for a main phone display backlight and 3 LEDs for a sub-display backlight. Regulated internal current sources deliver excellent current and brightness matching in all LEDs.

The LED driver current sources are split into two independently controlled groups. The primary group (Group A) can be used to backlight a main phone display with up to 4 LEDs. The low-side current drivers of Group A accommodate common-anode-type LEDs. The second group (Group B) can backlight a secondary display with up to 3 LEDs. The high-side current drivers of Group B accommodate common-cathode-type LEDs. Both Group A and Group B can also drive standard two-terminal LEDs, and provide other general lighting functions (keypad lighting, fun lighting, etc). The brightness of the two LED groups can be adjusted independently with external resistors.

The LM27961 works off an extended Li-Ion input voltage range (2.7V to 5.5V). Voltage boost is achieved with a high-efficiency 3/2x-gain charge pump.

The LM27961 is available in National's chip-scale 18-bump micro SMD package.

Features

- Drives 4 Individual Common-Anode LEDs with up to 20mA each for a Main Display Backlight
- Drives 3 Individual Common-Cathode LEDs with up to 20mA each for a Sub-Display Backlight
- Independent Resistor-Programmable Current Setting
- Excellent Current and Brightness Matching
- High-Efficiency 3/2x Charge Pump
- Extended Li-Ion Input: 2.7V to 5.5V
- PWM Brightness Control: 100Hz - 1kHz
- 18-bump Thin Micro SMD Package: (2.1mm x 2.4mm x 0.6mm)

Applications

- Mobile Phone Display Lighting
- Mobile Phone Keypad Lighting
- PDAs
- General LED Lighting

Typical Application Circuit

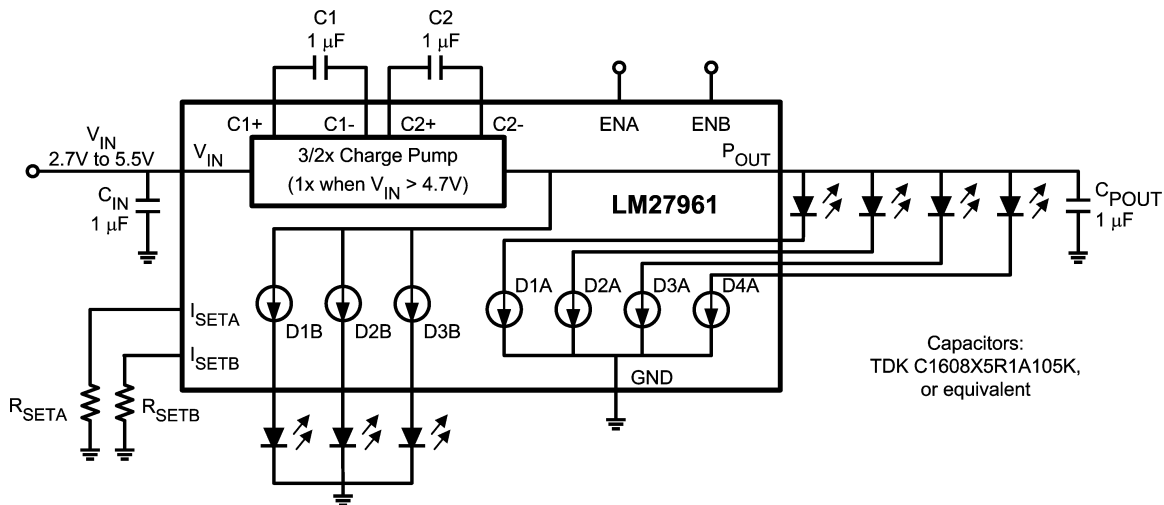

20127901

Connection Diagram

18-Bump Thin Micro SMD Package, Large Bump
NS Package Number TLA18

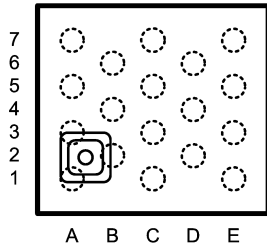

Top View

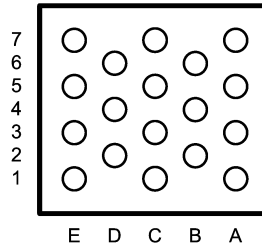

Bottom View

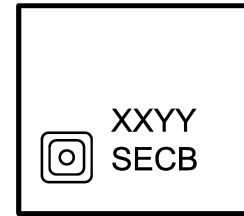

Package Marking
Top View

Note: The actual physical placement of the package marking will vary from part to part. The package marking "XX" designates the date code. "YY" is a NSC internal code for die traceability. Both will vary considerably. "SECB" identifies the device (part number, option, etc.).

20127902

Pin Description

Pin #s	Pin Names	Pin Descriptions
C1	V_{IN}	Input voltage. Input range: 2.7V to 5.5V.
D2	GND	Ground
A3	P_{OUT}	Charge pump output. Approximately $1.5 \times V_{IN}$
A1, B2, A5, E1	C1+, C1-, C2+, C2-	Flying capacitor connections.
D6, E5, D4, E3	D1A, D2A, D3A, D4A	LED Outputs - Group A
C5, B4, C3	D1B, D2B, D3B	LED Outputs - Group B
B6	EN-A	Enable for Group-A LEDs (current outputs). Logic input. High = Group-A LEDs ON. Low = Group A LEDs OFF. Pulsing this pin with a PWM signal (100Hz-1kHz) can be used to dim LEDs.
A7	EN-B	Enable for Group-B LEDs (current outputs). Logic input. High = Group-B LEDs ON. Low = Group B LEDs OFF. Pulsing this pin with a PWM signal (100Hz-1kHz) can be used to dim LEDs.
E7	I_{SETA}	Placing a resistor (R_{SETA}) between this pin and GND sets the LED current for Group A LEDs. LED Current = $100 \times (1.25V \div R_{SETA})$.
C7	I_{SETB}	Placing a resistor (R_{SETB}) between this pin and GND sets the LED current for Group B LEDs. LED Current = $100 \times (1.25V \div R_{SETB})$.

Operational States

ENA	ENB	Mode of Operation
L	L	Shutdown
H	L	Enabled. Group A LEDs ON. Group B LEDs OFF
L	H	Enabled. Group B LEDs ON. Group A LEDs OFF
H	H	Invalid for normal operation

Ordering Information

Order Information	Package	Supplied As
LM27961TL	TLA18 Micro SMD	250 Units, Tape & Reel
LM27961TLX		3000 Units, Tape & Reel

Absolute Maximum Ratings (Notes 1, 2)

If Military/Aerospace specified devices are required, please contact the National Semiconductor Sales Office/Distributors for availability and specifications.

V_{IN} pin voltage	-0.3V to 7.1V
ENA, ENB pin voltages	-0.3V to ($V_{IN}+0.3V$) w/ 6.0V max
I_{Dxx} Pin Voltages	-0.3V to ($V_{POUT}+0.3V$) w/ 6.0V max
Continuous Power Dissipation (Note 3)	Internally Limited
Junction Temperature (T_{J-MAX})	150°C
Storage Temperature Range	-65°C to +150° C
Maximum Lead Temperature (Soldering, 10 sec.)	265°C
ESD Rating (Note 4)	
Human Body Model - I_{Dxx} Pins:	1.0kV
Human Body Model - All other Pins:	2.0kV
Machine Model - I_{Dxx} Pins:	100V
Machine Model - All Other Pins:	200V

Electrical Characteristics (Notes 2, 7)

Limits in standard typeface are for $T_J = 25^\circ\text{C}$, and limits in boldface type apply over the full operating temperature range. Unless otherwise specified: $V_{IN} = 3.6V$; $V_{DxA} = 0.6V$; $V_{DxB} = 3.6V$; ENA = 1.5V and ENB = GND, or ENA = GND and ENB = 1.5V; $R_{SETA} = R_{SETB} = 8.35k\Omega$; C_{IN} , C_1 , C_2 , and $C_{POUT} = 1\mu\text{F}$. Specifications related to output current(s) and current setting pins (I_{Dxx} and I_{SETx}) apply to both Group A and Group B. (Note 8)

Operating Rating (Notes 1, 2)

Input Voltage Range	2.7V to 5.5V
Junction Temperature (T_J) Range	-30°C to +125°C
Ambient Temperature (T_A) Range (Note 5)	-30°C to +85°C

Thermal Properties

Junction-to-Ambient Thermal Resistance (θ_{JA}), (Note 6)	100°C/W
---	---------

Symbol	Parameter	Condition	Min	Typ	Max	Units
I_{Dxx}	Output Current Regulation	$3.0V \leq V_{IN} \leq 4.2V$, and $V_{IN} = 5.5V$ $0.45V \leq V_{DxA} \leq 3.8V$ or $2.5V \leq V_{DxB} \leq 3.8V$; $R_{SET} = 8.35k\Omega$	13.5 (-10%)	15	16.5 (+10%)	mA (%)
		$3.0V \leq V_{IN} \leq 5.5V$; $0.6V \leq V_{DxA} \leq 3.8V$ or $2.5V \leq V_{DxB} \leq 3.8V$; $R_{SET} = 6.25k\Omega$		20		mA
		$3.0V \leq V_{IN} \leq 5.5V$; $0.3V \leq V_{DxA} \leq 3.8V$ or $2.5V \leq V_{DxB} \leq 3.8V$; $R_{SET} = 12.5k\Omega$		10		mA
		$2.7V \leq V_{IN} \leq 3.0V$; $0.45V \leq V_{DxA} \leq 3.8V$ or $2.5V \leq V_{DxB} \leq 3.8V$; $R_{SET} = 8.35k\Omega$		15		mA
$I_{Dxx-MATCH}$	Current Matching Between Any Two Group A Outputs or Group B Outputs	$V_{IN} = 3.0V$ (Note 9)		0.6		%
I_Q	Quiescent Supply Current	$2.7V \leq V_{IN} \leq 4.2V$; No Load Current, ENA or ENB = ON		4.4	6.75	mA
I_{SD}	Shutdown Supply Current	$2.7V \leq V_{IN} \leq 5.5V$, ENA and ENB = OFF		2.3	5	μA
V_{SET}	I_{SET} Pin Voltage	$2.7V \leq V_{IN} \leq 5.5V$		1.25		V
I_{Dxx}/I_{SET}	Output Current to Current Set Ratio			100		

Electrical Characteristics (Notes 2, 7) (Continued)

Limits in standard typeface are for $T_J = 25^\circ\text{C}$, and limits in boldface type apply over the full operating temperature range. Unless otherwise specified: $V_{IN} = 3.6\text{V}$; $V_{DxA} = 0.6\text{V}$; $V_{DxB} = 3.6\text{V}$; $\text{ENA} = 1.5\text{V}$ and $\text{ENB} = \text{GND}$, or $\text{ENA} = \text{GND}$ and $\text{ENB} = 1.5\text{V}$; $R_{SETA} = R_{SETB} = 8.35\text{k}\Omega$; C_{IN} , C_1 , C_2 , and $C_{POUT} = 1\mu\text{F}$. Specifications related to output current(s) and current setting pins (I_{Dxx} and I_{SETx}) apply to both Group A and Group B. (Note 8)

Symbol	Parameter	Condition	Min	Typ	Max	Units
R_{OUT}	Charge Pump Output Resistance (Note 10)	$V_{IN} = 3.0\text{V}$		2.7		Ω
V_{HR}	Current Source Headroom Voltage Requirement (Note 11)	$I_{Dxx} = 95\% \times I_{Dxx}(\text{nom})$ $R_{SET} = 8.35\text{k}\Omega$ $(I_{Dxx}(\text{nom}) \approx 15\text{mA})$		320		mV
f_{SW}	Switching Frequency	$3.0\text{V} \leq V_{IN} \leq 4.2\text{V}$	375	500	625	kHz
t_{START}	Start-up Time	$I_{Dx} = 90\%$ steady state		350		μs
1.5x/1x	Charge pump gain cross-over: Gain = 1.5 when V_{IN} is below threshold. Gain = 1 when V_{IN} is above threshold.	1.5x to 1x Threshold		4.75		V
		1x to 1.5x Threshold		4.55		V

Logic Pin Specifications: EN, ENA, ENB

V_{IL}	Input Logic Low	$2.7\text{V} \leq V_{IN} \leq 5.5\text{V}$	0		0.5	V
V_{IH}	Input Logic High	$2.7\text{V} \leq V_{IN} \leq 5.5\text{V}$	1.1		V_{IN}	V
I_{LEAK}	Input Leakage Current	$V_{ENx} = 0\text{V}$		0.1		μA
		$V_{ENx} = 3\text{V}$ (Note 12)		10		

Note 1: Absolute Maximum Ratings indicate limits beyond which damage to the component may occur. Operating Ratings are conditions under which operation of the device is guaranteed. Operating Ratings do not imply guaranteed performance limits. For guaranteed performance limits and associated test conditions, see the Electrical Characteristics tables.

Note 2: All voltages are with respect to the potential at the GND pin.

Note 3: Internal thermal shutdown circuitry protects the device from permanent damage. Thermal shutdown engages at $T_J = 160^\circ\text{C}$ (typ.) and disengages at $T_J = 120^\circ\text{C}$ (typ.). The thermal shutdown function is guaranteed by design.

Note 4: The Human body model is a 100pF capacitor discharged through a 1.5k Ω resistor into each pin. The machine model is a 200pF capacitor discharged directly into each pin. MIL-STD-883 3015.7

Note 5: In applications where high power dissipation and/or poor package thermal resistance is present, the maximum ambient temperature may have to be derated. Maximum ambient temperature (T_{A-MAX}) is dependent on the maximum operating junction temperature ($T_{J-MAX-OP} = 125^\circ\text{C}$), the maximum power dissipation of the device in the application (P_{D-MAX}), and the junction-to ambient thermal resistance of the part/package in the application (θ_{JA}), as given by the following equation: $T_{A-MAX} = T_{J-MAX-OP} - (\theta_{JA} \times P_{D-MAX})$.

Note 6: Junction-to-ambient thermal resistance is highly dependent on application and board layout. In applications where high maximum power dissipation exists, special care must be paid to thermal dissipation issues in board design.

Note 7: Min and Max limits are guaranteed by design, test, or statistical analysis. Typical numbers are not guaranteed, but do represent the most likely norm.

Note 8: C_{IN} , C_{POUT} , C_1 , and C_2 : Low-ESR Surface-Mount Ceramic Capacitors (MLCCs) used in setting electrical characteristics

Note 9: For the two groups of outputs on a part (Group A and Group B), the following are determined: the maximum output current in the group (MAX), the minimum output current in the group (MIN), and the average output current of the group (AVG). For each group, two matching numbers are calculated: (MAX-AVG)/AVG and (AVG-MIN)/AVG. The largest number of the two (worst case) is considered the matching figure for the group. The matching figure for a given part is considered to be the highest matching figure of the two groups. The typical specification provided is the most likely norm of the matching figure for all parts.

Note 10: Output resistance (R_{OUT}) models all voltage losses in the charge pump. R_{OUT} can be used to estimate the voltage at the charge pump output (P_{OUT}): $V_{Pout} = (1.5 \times V_{IN}) - (R_{OUT} \times I_{OUT})$. In the equation, I_{OUT} is the total output current: the sum of all active Dxx output currents and all current drawn from P_{OUT} . The equation applies when the charge pump is operating with a gain of 3/2 ($V_{IN} \leq 4.75\text{V}$ typ.).

Note 11: Headroom voltage: $V_{HR} = V_{Pout} - V_{LEDx}$. If headroom voltage requirement is not met, LED current regulation will be compromised.

Note 12: There is a 300k Ω (typ.) pull-down resistor connected internally between each enable pin (ENA, ENB) and GND.

Typical Performance Characteristics Unless otherwise specified: $V_{IN} = 3.6V$; $V_{LEDxA} = 3.6V$; $V_{LEDxB} = 3.6V$; $ENA = V_{IN}$ and $ENB = GND$, or $ENA = GND$ and $ENB = V_{IN}$; $R_{SETA} = R_{SETB} = 8.35k\Omega$; C_{IN} , C_1 , C_2 , and $C_{POUT} = 1\mu F$.

LED Current (D1A, D2A,D3A, D4A) vs. Input Voltage

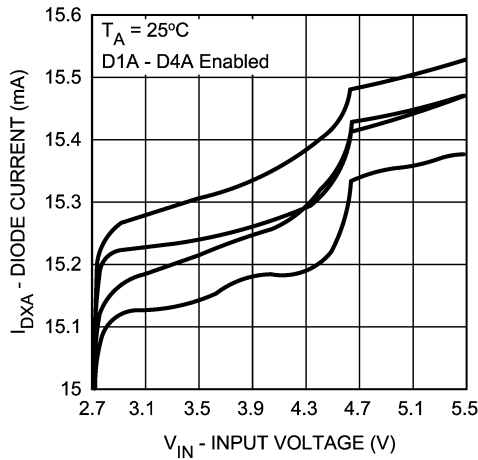

20127904

LED Current (DxA) vs. Input Voltage

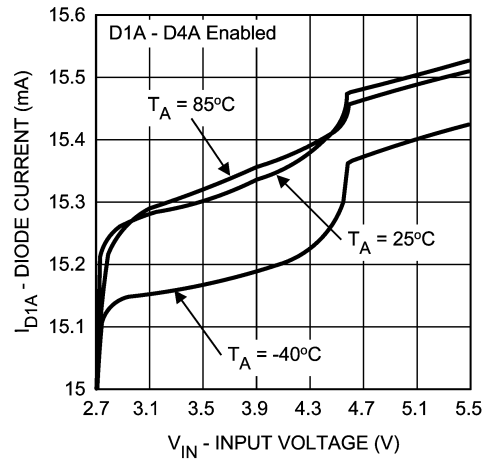

20127905

Quiescent Current vs. Input Voltage,

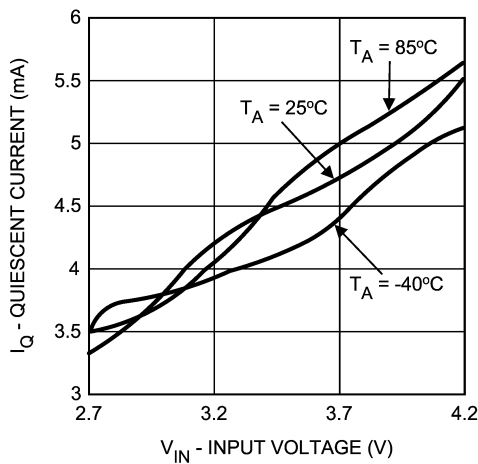

20127906

Charge Pump Output Voltage vs. Output Current

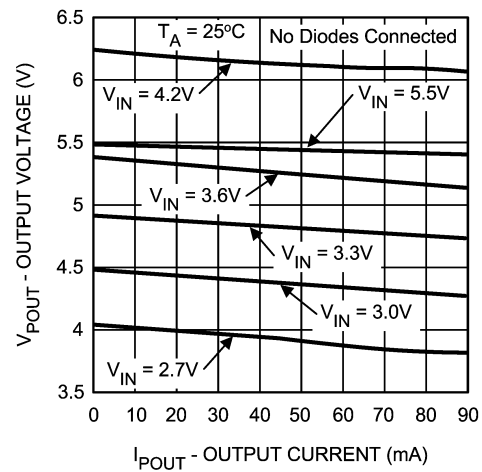

20127907

Typical Performance Characteristics Unless otherwise specified: $V_{IN} = 3.6V$; $V_{LEDxA} = 3.6V$; $V_{LEDxB} = 3.6V$; $EN_A = V_{IN}$ and $EN_B = GND$, or $EN_A = GND$ and $EN_B = V_{IN}$; $R_{SETA} = R_{SETB} = 8.35k\Omega$; C_{IN} , C_1 , C_2 , and $C_{POUT} = 1\mu F$. (Continued)

Charge Pump Output Voltage vs. Output Current

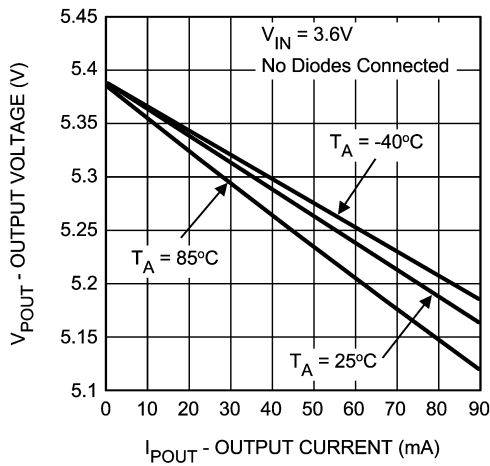

20127910

Charge Pump Output Voltage vs. Input Voltage (No Load Current)

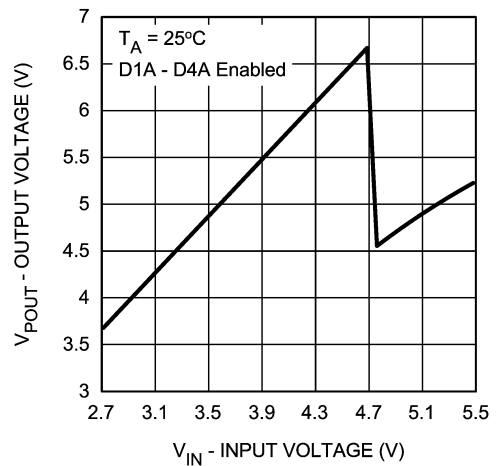

20127908

Input Current vs. Input Voltage

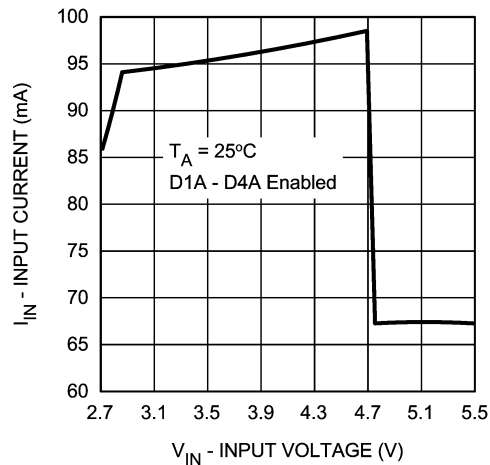

20127909

Charge Pump Output Resistance vs. Output Current

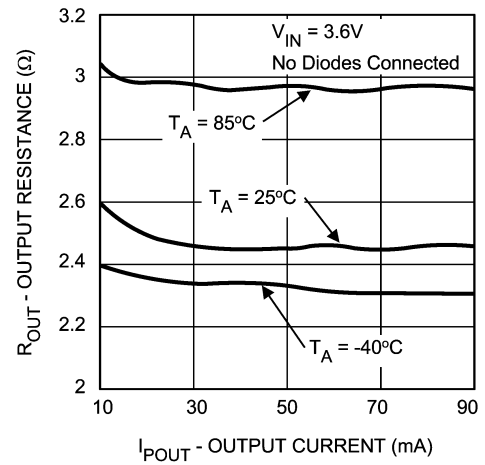

20127911

Typical Performance Characteristics Unless otherwise specified: $V_{IN} = 3.6V$; $V_{LEDxA} = 3.6V$; $V_{LEDxB} = 3.6V$; $ENA = V_{IN}$ and $ENB = GND$, or $ENA = GND$ and $ENB = V_{IN}$; $R_{SETA} = R_{SETB} = 8.35k\Omega$; C_{IN} , C_1 , C_2 , and $C_{POUT} = 1\mu F$. (Continued)

Charge Pump Switching Frequency vs. Input Voltage

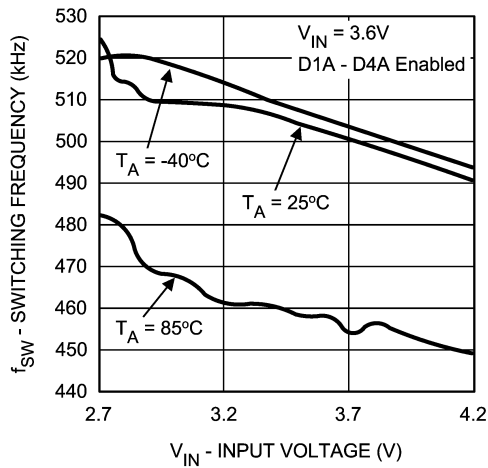

20127912

Diode Current (DxA) vs. Headroom Voltage (DxA)

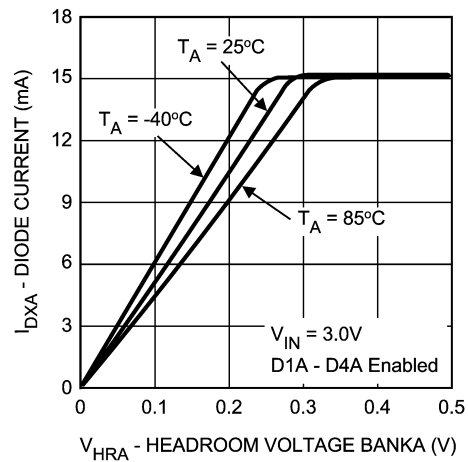

20127913

Diode Current (DxB) vs. Headroom Voltage (DxB)

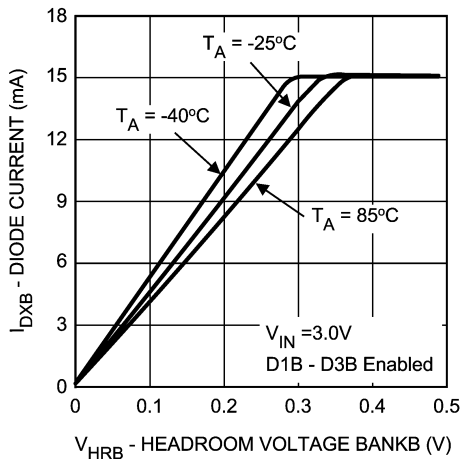

20127914

Diode Current (DxA or DxB) vs. PWM Duty Cycle (ENA or ENB)

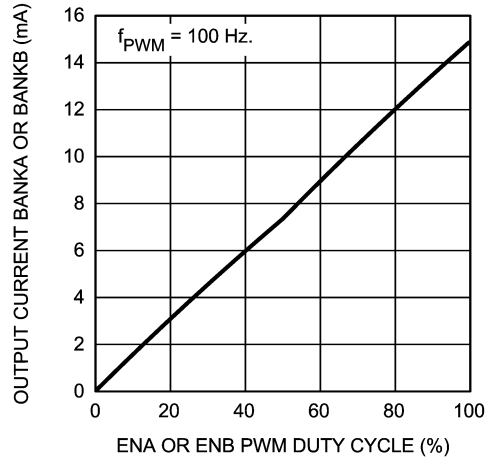

20127915

Typical Performance Characteristics Unless otherwise specified: $V_{IN} = 3.6V$; $V_{LEDxA} = 3.6V$; $V_{LEDxB} = 3.6V$; $ENA = V_{IN}$ and $ENB = GND$, or $ENA = GND$ and $ENB = V_{IN}$; $R_{SETA} = R_{SETB} = 8.35k\Omega$; C_{IN} , C_1 , C_2 , and $C_{POUT} = 1\mu F$. (Continued)

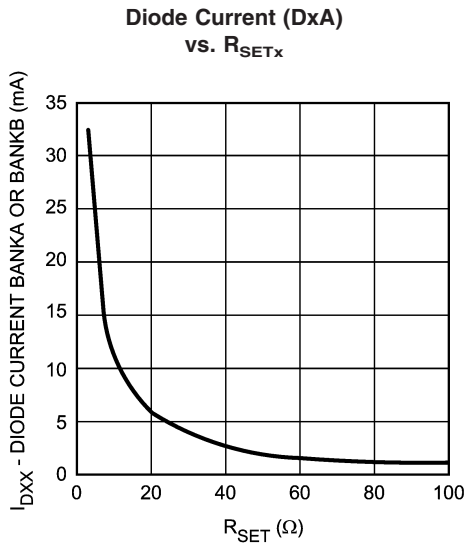

**Input Voltage (Top)
and Output Voltage (Bottom) Waveforms**

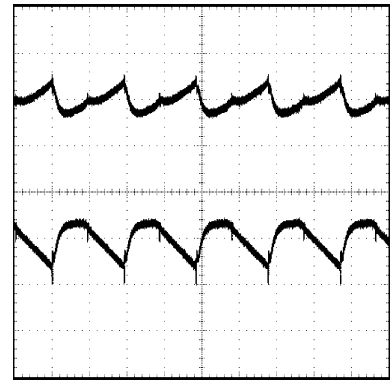

**Vertical Scale = (100mV/div),
Horizontal Scale = 1μs/div**

**ENx Signal (Top)
and Charge Pump Start-Up (Bottom) Waveforms**

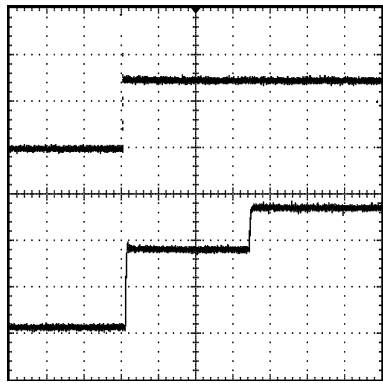

**Vertical Scale = (2V/div),
Horizontal Scale = 100μs/div**

Circuit Description (Continued)

anode outputs and a group of 3 common cathode outputs. There is an ON/OFF control pin for each group (ENA and ENB).

The DC current through the LEDs is programmed with an external resistor. Changing currents on-the-fly can be achieved with the use of digital pulse (PWM) signals.

ENABLE PINS: ENA, ENB

The LM27961 has 2 enable pins. Both are active-high logic (HIGH = ON). There are internal pull-down resistors (300kΩ typ.) that are connected internally between each of the enable pins and GND.

ENA and ENB can both enable and disable the part. When the voltage on both pins are low (<0.5V), the part is in shutdown mode. All internal circuitry is OFF and the part consumes very little supply current when the LM27961 is shutdown. When the voltage on either ENx pin is high (>1.1V), the part is active. The charge pump is ON, and the corresponding output current drivers are active.

ENA and ENB are used to turn the output currents ON and OFF. ENA activates/deactivates the four GroupA outputs (D1A-D4A). ENB activates/deactivates the three GroupB outputs (D1B-D3B).

SETTING LED CURRENTS

The output currents of the LM27961 can be set to a desired value simply by connecting an appropriately sized resistor (R_{SETx}) between the I_{SETx} pins of the LM27961 and GND. R_{SETA} sets the current for the GroupA outputs and R_{SETB} sets the current for the GroupB outputs. The output currents (LED currents) are proportional to the current that flows out of the I_{SETx} pins. The output currents are a factor of 100 greater than the I_{SETx} current. The feedback loop of an internal amplifier sets the voltage of the I_{SETx} pin to 1.25V (typ.). Placing a resistor between I_{SETx} and GND programs the I_{SETx} current, and thus the LED currents. The statements above are simplified in the equations below:

$$I_{Dxx} = 100 \times (V_{SETx} / R_{SETx})$$

$$R_{SETx} = 100 \times (1.25V / I_{Dxx})$$

MAXIMUM OUTPUT CURRENT, MAXIMUM LED VOLTAGE, MINIMUM INPUT VOLTAGE

The LM27961 can drive 4 LEDs at 15mA each from an input voltage as low as 2.7V, so long as the LEDs have a forward voltage of 3.5V or less (room temperature).

The statement above is a simple example of the LED drive capabilities of the LM27961. The statement contains the key application parameters that are required to validate an LED-drive design using the LM27961: LED current (I_{LEDx}), number of active LEDs (N), LED forward voltage (V_{LED}), and minimum input voltage (V_{IN-MIN}).

The equation below can be used to estimate the total output current capability of the LM27961:

$$I_{LED_MAX} = ((1.5 \times V_{IN}) - V_{LED}) / ((N \times R_{OUT}) + k_{HR}) \quad (\text{eq. 1})$$

$$I_{LED_MAX} = ((1.5 \times V_{IN}) - V_{LED}) / ((N \times 2.7\Omega) + 22\text{mV/mA})$$

R_{OUT} – Output resistance. This parameter models the internal losses of the charge pump that result in voltage droop at the pump output P_{OUT} . Since the magnitude of the voltage droop is proportional to the total output current of the charge pump, the loss parameter is modeled as a resistance. The output resistance of the LM27961 is typically 2.7Ω ($V_{IN} = 3.0V$, $T_A = 25^\circ\text{C}$). In equation form:

$$V_{POUT} = 1.5 \times V_{IN} - N \times I_{LED} \times R_{OUT} \quad (\text{eq. 2})$$

k_{HR} – Headroom constant. This parameter models the minimum voltage required to be present across the current sources for them to regulate properly. This minimum voltage is proportional to the programmed LED current, so the constant has units of mV/mA. The typical k_{HR} of the LM27961 is 22mV/mA. In equation form:

$$(V_{POUT} - V_{LED}) > k_{HR} \times I_{LED} \quad (\text{eq. 3})$$

The " I_{LED_MAX} " equation (eq. 1) is obtained from combining the R_{OUT} equation (eq. 2) with the k_{HR} equation (eq. 3) and solving for I_{LED} . Maximum LED current is highly dependent on minimum input voltage and LED forward voltage. Output current capability can be increased by raising the minimum input voltage of the application, or by selecting an LED with a lower forward voltage. Excessive power dissipation may also limit output current capability of an application.

PARALLEL Dx OUTPUTS FOR INCREASED CURRENT CAPABILITY

Outputs D1A through D4A, or D1B through D3B may be connected together in any combination to drive higher currents through fewer LEDs. For example in *Figure 1*, outputs D1A and D2A are connected together to drive one LED. D3A and D4A are connected to drive a second LED.

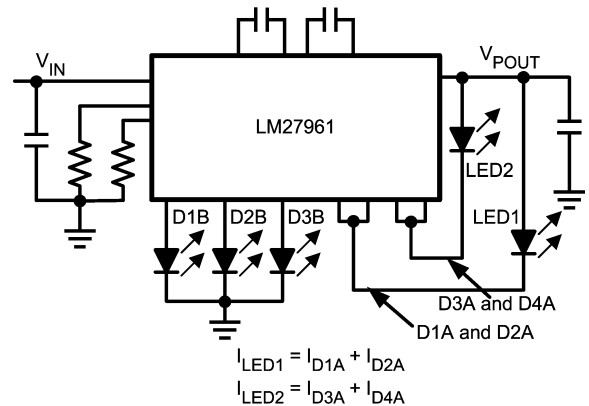

20127919

FIGURE 1. Two Parallel Connected LEDs

With this configuration, two parallel current sources of equal value provide current to one of the LEDs. R_{SET} should therefore be chosen so that the current through each output is programmed to 50% of the desired current through the parallel connected LED. For example, if 40mA is the desired drive current for the parallel connected LED, R_{SETx} should be selected so that the current through each of the outputs is 20mA. Other combinations of parallel outputs may be implemented in similar fashions, such as in *Figure 2*.

Circuit Description (Continued)

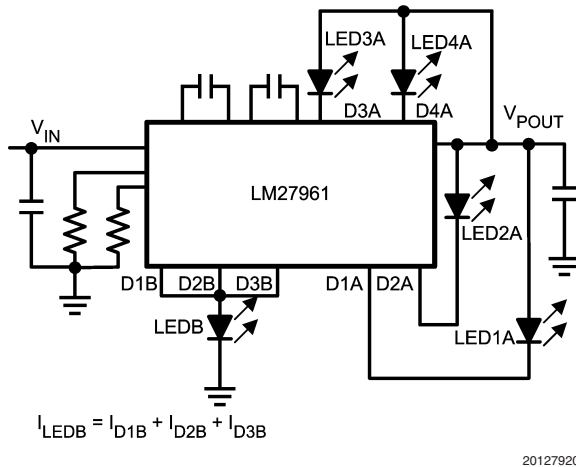

FIGURE 2. One Parallel Connected LED

Connecting outputs in parallel does not affect internal operation of the LM27961 and has no impact on the Electrical Characteristics and limits previously presented. The available diode output current, maximum diode voltage, and all other specifications provided in the Electrical Characteristics table apply to parallel output configurations, just as they do to the standard application circuit on pg1 of the datasheet.

SOFT START

The LM27961 contains internal soft-start circuitry to limit input inrush currents when the part is enabled. Soft start is implemented with a controlled turn-on of the internal voltage reference. During soft start, the current through the LED outputs rise at the rate of the reference voltage ramp. Due to the soft-start circuitry, turn-on time of the LM27961 is approximately 350 μ s (typ.).

THERMAL PROTECTION

Internal thermal protection circuitry disables the LM27961 when the junction temperature exceeds 160 $^{\circ}$ C (typ.). This feature protects the device from being damaged by high die temperatures that might otherwise result from excessive power dissipation. The device will recover and operate normally when the junction temperature falls below 120 $^{\circ}$ C (typ.). It is important that the board layout provides good thermal conduction. This will help to keep the junction temperature within specified operating ratings.

Applications Information

POWER EFFICIENCY

Efficiency of LED drivers is commonly taken to be the ratio of power consumed by the LEDs (P_{LED}) to the power drawn at the input of the part (P_{IN}). With a 1.5x charge pump, the input current is approximately 1.5x the output current (total LED current). For a simple approximation, the current consumed by internal circuitry can be neglected and the efficiency of the LM27961 can be predicted as follows:

$$E = \frac{P_{LED}}{P_{IN}} \cong \frac{V_{LED}}{1.5 \times V_{IN}}$$

Neglecting I_Q will result in a slightly higher efficiency prediction, but this impact will be no more than a few percentage points when several LEDs are driven at full power.

ADJUSTING LED BRIGHTNESS (PWM control)

Perceived LED brightness can be adjusted using a PWM control signal to turn the LM27961 current sources ON and OFF at a rate faster than perceptible by the eye. When this is done, the total brightness perceived is proportional to the duty cycle (D) of the PWM signal (D = the percentage of time that the LED is on in every PWM cycle). A simple example: if the LEDs are driven at 15mA each with a PWM signal that has a 50% duty cycle, perceived LED brightness will be about half as bright as compared to when the LEDs are driven continuously with 15mA. A PWM signal thus provides brightness (dimming) control for the solution.

The minimum recommended PWM frequency is 100Hz. Frequencies below this may be visibly noticeable as flicker or blinking. The maximum recommended PWM frequency is 1kHz. Frequencies above this may cause interference with internal current driver circuitry.

In cases where a PWM signal must be connected to the ENx pins, measures can be taken to reduce the magnitude of the charge-pump turn-on voltage spikes. More input capacitance, series resistors and/or ferrite beads may provide benefits.

If the current and voltage spikes can be tolerated, connecting the PWM signal to the EN pin does provide a benefit: lower supply current when the PWM signal is active. When the PWM signal is low, the LM27961 will be shutdown and input current will only be a few micro-amps. This results in a lower time-averaged input current.

CAPACITOR SELECTION

The LM27961 requires 4 external capacitors for proper operation. Surface-mount multi-layer ceramic capacitors are recommended. These capacitors are small, inexpensive and have very low equivalent series resistance (ESR <20mW typ.). Tantalum capacitors, OS-CON capacitors, and aluminum electrolytic capacitors are not recommended for use with the LM27961 due to their high ESR, as compared to ceramic capacitors.

For most applications, ceramic capacitors with X7R or X5R temperature characteristic are preferred for use with the LM27961. These capacitors have tight capacitance tolerance (as good as $\pm 10\%$) and hold their value over temperature (X7R: $\pm 15\%$ over -55 $^{\circ}$ C to 125 $^{\circ}$ C; X5R: $\pm 15\%$ over -55 $^{\circ}$ C to 85 $^{\circ}$ C).

Capacitors with Y5V or Z5U temperature characteristic are generally not recommended for use with the LM27961. Capacitors with these temperature characteristics typically have wide capacitance tolerance (+80%, -20%) and vary significantly over temperature (Y5V: +22%, -82% over -30 $^{\circ}$ C to +85 $^{\circ}$ C range; Z5U: +22%, -56% over +10 $^{\circ}$ C to +85 $^{\circ}$ C range). Under some conditions, a nominal 1 μ F Y5V or Z5U capacitor could have a capacitance of only 0.1 μ F. Such detrimental deviation is likely to cause Y5V and Z5U capacitors to fail to meet the minimum capacitance requirements of the LM27961.

Applications Information (Continued)

The voltage rating of the output capacitor should be 10V or more. All other capacitors should have a voltage rating at or above the maximum input voltage of the application.

CIRCUIT BOARD LAYOUT

For optimal, low-noise performance, all capacitors (C_{IN} , C_{POUT} , C1, C2) should be placed very close to the LM27961. A solid ground plane should be used for IC and component GND connections. Refer to the LM27961 Evaluation Board for an example layout.

MICRO SMD MOUNTING

The LM27961 is an 18-bump micro SMD with a bump size of approximately 300 micron diameter. The micro SMD package requires specific mounting techniques detailed in National Semiconductor Application Note 1112 (AN-1112).

