

FEATURES

- *Guaranteed max. 0.5 μ V/ $^{\circ}$ C Drift*
- *Guaranteed max. 0.6 μ V pk-pk Noise*
- *Guaranteed max. 2nA Bias Current*
- *Guaranteed minimum 114dB CMRR*

APPLICATIONS

- Strain Gauges
- Thermocouple Amplifiers
- Instrumentation Amplifiers
- Medical Instruments

DESCRIPTION

The OP-05 is an internally compensated op-amp which provides excellent input offset voltage, low bias current, very high common mode rejection, and low offset voltage drift with temperature when the input offset voltage is externally trimmed to zero. Direct replacement of similar devices in existing systems can result in significant system performance improvement without redesign. The OP-05 is particularly well suited for instrumentation and low signal level applications where precision and stability over time and temperature are important. Internal frequency compensation enhances the OP-05's versatility for a wide variety of precision op-amp uses. Linear's advanced design, process and test techniques ensure device performance as well as reliability. An instrumentation amplifier application is shown below. For higher performance requirements see the LT1001 single precision op amp and the LT1002 dual matched precision op amp series.

2

Instrumentation Amplifier

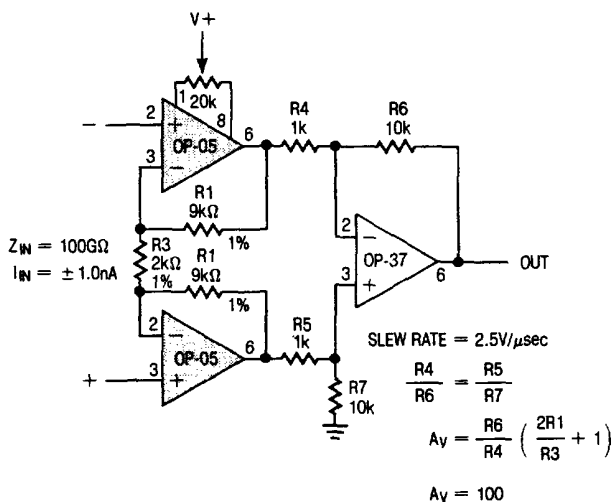

Trimmed Offset Voltage with Temperature of Six Representative Units

(Offset Trimmed to Zero at 25 $^{\circ}$ C with 20k Ω Pot)

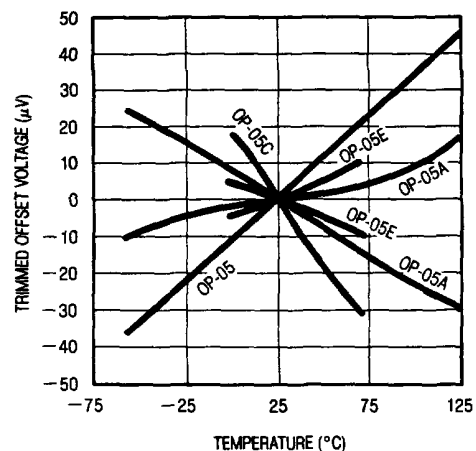

ABSOLUTE MAXIMUM RATINGS

Supply Voltage $\pm 22V$
 Differential Input Voltage $\pm 30V$
 Input Voltage Equal to Supply Voltage
 Output Short Circuit Duration Indefinite
 Operating Temperature Range
 OP-05/OP-05A $-55^{\circ}C$ to $125^{\circ}C$
 OP-05E/OP-05C $0^{\circ}C$ to $70^{\circ}C$
 Storage Temperature Range
 All Devices $-65^{\circ}C$ to $150^{\circ}C$
 Lead Temperature (Soldering, 10 sec.) $300^{\circ}C$

PACKAGE/ORDER INFORMATION

<p>TOP VIEW OFFSET ADJUST METAL CAN H PACKAGE</p>	ORDER PART NO.	OFFSET VOLTAGE MAX
	OP-05AH OP-05H OP-05EH OP-05CH	0.15mV 0.5mV 0.5mV 1.3mV
<p>TOP VIEW HERMETIC J8 PACKAGE PLASTIC DIP N8 PACKAGE</p>	ORDER PART NO.	OFFSET VOLTAGE MAX
	OP-05AJ8 OP-05J8 OP-05EJ8 OP-05CJ8 OP-05EN8 OP-05CN8	0.15mV 0.5mV 0.5mV 1.3mV 0.5mV 1.3mV

ELECTRICAL CHARACTERISTICS $V_S = \pm 15V, T_A = 25^{\circ}C$, unless otherwise noted.

SYMBOL	PARAMETER	CONDITIONS	OP-05A			OP-05			UNITS
			MIN	TYP	MAX	MIN	TYP	MAX	
V_{OS}	Input Offset Voltage			0.07	0.15		0.2	0.5	mV
$\frac{\Delta V_{OS}}{\Delta Time}$	Long Term Input Offset Voltage Stability	(Notes 1 and 2)		0.2	1.0		0.2	1.0	$\mu V/$ Month
I_{OS}	Input Offset Current			0.7	2.0		1.0	2.8	nA
I_B	Input Bias Current			± 0.7	± 2.0		± 1.0	± 3.0	nA
e_n	Input Noise Voltage	0.1Hz to 10Hz (Note 2)		0.35	0.6		0.35	0.6	μV_{p-p}
	Input Noise Voltage Density	$f_o = 10Hz$ $f_o = 100Hz$ (Note 2) $f_o = 1000Hz$		10.3 10.0 9.6	18.0 13.0 11.0		10.3 10.0 9.6	18.0 13.0 11.0	nV/\sqrt{Hz}
i_n	Input Noise Current	0.1Hz to 10Hz (Note 2)		14	30		14	30	pA_{p-p}
	Input Noise Current Density	$f_o = 10Hz$ $f_o = 100Hz$ (Note 2) $f_o = 1000Hz$		0.32 0.14 0.12	0.80 0.23 0.17		0.32 0.14 0.12	0.80 0.23 0.17	pA/\sqrt{Hz}
R_{in}	Input Resistance Differential Mode	(Note 3)	30	80		20	60		M Ω
	Input Resistance Common Mode			200			200		G Ω
	Input Voltage Range		± 13.5	± 14.0		± 13.5	± 14.0		V
CMRR	Common Mode Rejection Ratio	$V_{CM} = \pm 13.5V$	114	126		114	126		dB
PSRR	Power Supply Rejection Ratio	$V_S = \pm 3V$ to $\pm 18V$	100	108		100	108		dB
A_{VOL}	Large Signal Voltage Gain	$R_L \geq 2k\Omega, V_o = \pm 10V$ $R_L \geq 500\Omega, V_o = \pm 0.5V$ $V_S = \pm 3V$ (Note 3)	300 150	500 500		200 150	500 500		V/mV
V_{OUT}	Maximum Output Voltage Swing	$R_L \geq 10k\Omega$ $R_L \geq 2k\Omega$ $R_L \geq 1k\Omega$	± 12.5 ± 12.0 ± 10.5	± 13.0 ± 12.8 ± 12.0		± 12.5 ± 12.0 ± 10.5	± 13.0 ± 12.8 ± 12.0		V
SR	Slew Rate	$R_L \geq 2k\Omega$ (Note 2)	0.1	0.3		0.1	0.3		V/ μS
GBW	Closed Loop Bandwidth	$A_{VCL} = +1$ (Note 2)	0.4	0.6		0.4	0.6		MHz
Z_o	Open Loop Output Impedance	$V_o = 0, I_o = 0, f = 10Hz$		60			60		Ω
P_d	Power Dissipation	No load $V_S = \pm 3V$, No load		90 4	120 6		90 4	120 6	mW
	Offset Adjustment Range	Null Pot = 20k Ω		± 4			± 4		mV

See Notes on page 2-324

ELECTRICAL CHARACTERISTICS $V_S = \pm 15V$, $-55^\circ C \leq T_A \leq 125^\circ C$, unless otherwise noted.

SYMBOL	PARAMETER	CONDITIONS	OP-05A			OP-05			UNITS
			MIN	TYP	MAX	MIN	TYP	MAX	
V_{OS}	Input Offset Voltage			0.10	0.24		0.3	0.7	mV
$\frac{\Delta V_{OS}}{\Delta Temp}$	Average Input Offset Voltage Drift Without External Trim With External Trim	Null Pot = 20k Ω (Note 2)		0.3 0.2	0.9 0.5		0.7 0.3	2.0 1.0	$\mu V/^\circ C$
I_{OS}	Input Offset Current			1.0	4.0		1.8	5.6	nA
$\frac{\Delta I_{OS}}{\Delta Temp}$	Average Input Offset Current Drift	(Note 2)		5	25		8	50	pA/°C
I_B	Input Bias Current			± 1.0	± 4.0		± 2.0	± 6.0	nA
$\frac{\Delta I_B}{\Delta Temp}$	Average Input Bias Current Drift	(Note 2)		8	25		13	50	pA/°C
	Input Voltage Range		± 13.0	± 13.5		± 13.0	± 13.5		V
CMRR	Common Mode Rejection Ratio	$V_{CM} = \pm 13V$	110	123		110	123		dB
PSRR	Power Supply Rejection Ratio	$V_S = \pm 3V$ to $\pm 18V$	94	106		94	106		dB
A_{VOL}	Large Signal Voltage Gain	$R_L \geq 2k\Omega$, $V_o = \pm 10V$	200	400		150	400		V/mV
V_{OUT}	Output Voltage Swing	$R_L \geq 2k\Omega$	± 12.0	± 12.6		± 12.0	± 12.6		V

ELECTRICAL CHARACTERISTICS $V_S = \pm 15V$, $T_A = 25^\circ C$, unless otherwise noted.

SYMBOL	PARAMETER	CONDITIONS	OP-05E			OP-05C			UNITS
			MIN	TYP	MAX	MIN	TYP	MAX	
V_{OS}	Input Offset Voltage			0.2	0.5		0.3	1.3	mV
$\frac{\Delta V_{OS}}{\Delta Time}$	Long Term Input Offset Voltage Stability	(Notes 1 and 2)		0.3	1.5		0.4	2.0	$\mu V/Month$
I_{OS}	Input Offset Current			1.2	3.8		1.8	6.0	nA
I_B	Input Bias Current			± 1.2	± 4.0		± 1.8	± 7.0	nA
e_n	Input Noise Voltage	0.1Hz to 10Hz (Note 2)		0.35	0.6		0.38	0.65	μV_{p-p}
	Input Noise Voltage Density	$f_o = 10Hz$ $f_o = 100Hz$ (Note 2) $f_o = 1000Hz$		10.3 10.0 9.6	18.0 13.0 11.0		10.5 10.2 9.8	20.0 13.5 11.5	nV/\sqrt{Hz}
i_n	Input Noise Current	0.1Hz to 10Hz (Note 2)		14	30		15	35	pA $_{p-p}$
	Input Noise Current Density	$f_o = 10Hz$ $f_o = 100Hz$ (Note 2) $f_o = 1000Hz$		0.32 0.14 0.12	0.80 0.23 0.17		0.35 0.15 0.13	0.90 0.27 0.18	pA/ \sqrt{Hz}
R_{in}	Input Resistance Differential Mode	(Note 3)	15	50		8	33		M Ω
	Input Resistance Common Mode			160			120		G Ω
	Input Voltage Range		± 13.5	± 14.0		± 13.5	± 14.0		V
CMRR	Common Mode Rejection Ratio	$V_{CM} = \pm 13.5V$	110	123		100	120		dB
PSRR	Power Supply Rejection Ratio	$V_S = \pm 3V$ to $\pm 18V$	94	106		90	104		dB
A_{VOL}	Large Signal Voltage Gain	$R_L \geq 2k\Omega$, $V_o = \pm 10V$ $R_L \geq 500\Omega$, $V_o = \pm 0.5V$ $V_S = \pm 3V$ (Note 3)	200 150	500 500		120 100	400 400		V/mV
V_{OUT}	Maximum Output Voltage Swing	$R_L \geq 10k\Omega$ $R_L \geq 2k\Omega$ $R_L \geq 1k\Omega$	± 12.5 ± 12.0 ± 10.5	± 13.0 ± 12.8 ± 12.0		± 12.0 ± 11.5 ± 12.0	± 13.0 ± 12.8 ± 12.0		V
SR	Slew Rate	$R_L \geq 2k\Omega$ (Note 2)	0.1	0.3		0.1	0.3		V/ μS
GBW	Closed Loop Bandwidth	$A_{VCL} = +1$ (Note 2)	0.4	0.6		0.4	0.6		MHz
Z_o	Open Loop Output Impedance	$V_o = 0$, $I_o = 0$, $f = 10Hz$		60			60		Ω
P_d	Power Dissipation	No load $V_S = \pm 3V$, No load	90 4	120 6		95 4	150 8		mW
	Offset Adjustment Range	Null Pot = 20k Ω		± 4			± 4		mW

See Notes on page 2-324

ELECTRICAL CHARACTERISTICS $V_S = \pm 15V, 0^\circ C \leq T_A \leq 70^\circ C.$

SYMBOL	PARAMETER	CONDITIONS	OP-05E			OP-05C			UNITS
			MIN	TYP	MAX	MIN	TYP	MAX	
V_{OS}	Input Offset Voltage		●	0.25	0.6		0.35	1.6	mV
$\frac{\Delta V_{OS}}{\Delta Temp}$	Average Input Offset Voltage Drift Without External Trim With External Trim	Null Pot = 20k Ω (Note 2)	●	0.7	2.0		1.3	4.5	$\mu V/^\circ C$
			●	0.2	0.6		0.4	1.5	
I_{OS}	Input Offset Current		●	1.4	5.3		2.0	8.0	nA
$\frac{\Delta I_{OS}}{\Delta Temp}$	Average Input Offset Current Drift	(Note 2)	●	8	35		12	50	$\mu A/^\circ C$
I_B	Input Bias Current		●	± 1.5	± 5.5		± 2.2	± 9.0	nA
$\frac{\Delta I_B}{\Delta Temp}$	Average Input Bias Current Drift	(Note 2)	●	13	35		18	50	$\mu A/^\circ C$
	Input Voltage Range		●	± 13.0	± 13.5		± 13.0	± 13.5	V
CMRR	Common Mode Rejection Ratio	$V_{CM} = \pm 13V$	●	107	123		97	120	dB
PSRR	Power Supply Rejection Ratio	$V_S = \pm 3V$ to $\pm 18V$	●	90	103		86	100	dB
A_{VOL}	Large Signal Voltage Gain	$R_L \geq 2k\Omega, V_o = \pm 10V$	●	180	450		100	400	V/mV
V_{OUT}	Output Voltage Swing	$R_L \geq 2k\Omega$	●	± 12.0	± 12.6		± 11.0	± 12.6	V

The ● denotes the specifications which apply over the full operating temperature range.

Note 1: Long term offset voltage stability is the average value of offset voltage vs. time plotted over extended periods following 30 days of operation. Values for time under 30 days of operation are typically 2.5 μV following the first hour of operation.

Note 2: This parameter is sample tested.

Note 3: This parameter is guaranteed by design.

TYPICAL PERFORMANCE CHARACTERISTICS

**Low Frequency Noise
(Closed Loop Gain = 25,000)**

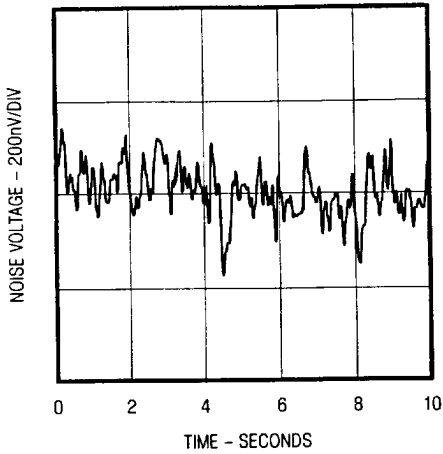

**Total Input Noise Voltage
vs Frequency**

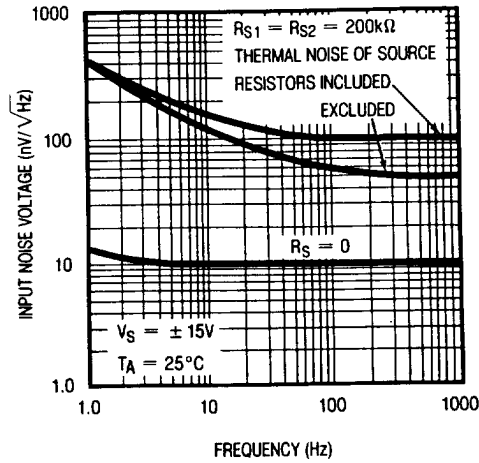

**Open-Loop
Frequency Response**

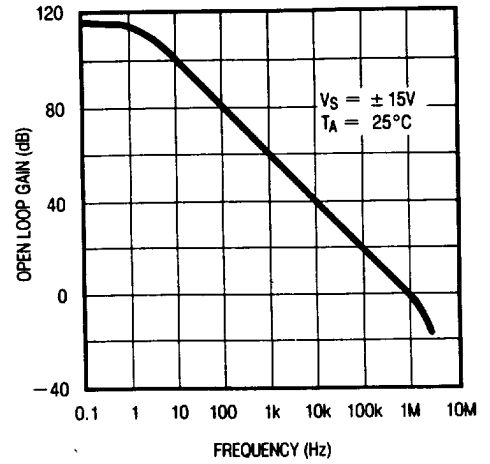

**Common Mode Rejection Ratio
vs Frequency**

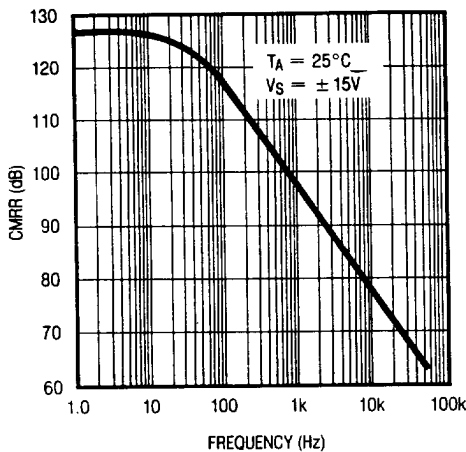

**Power Supply Rejection Ratio
vs Frequency**

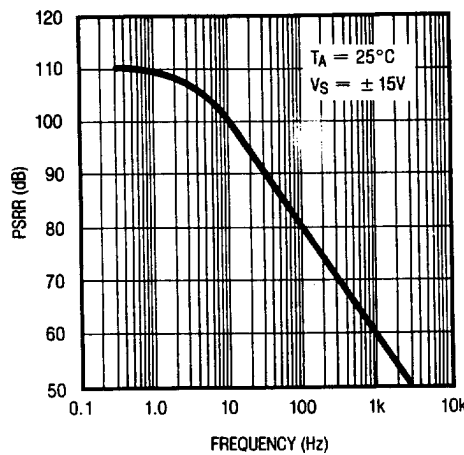

**Long Term Stability of Four
Representative Units**

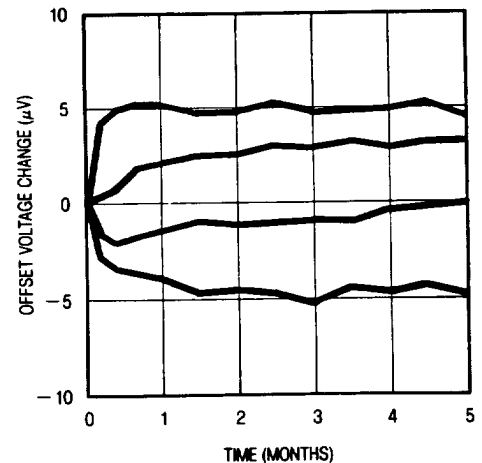

Warm-Up Drift

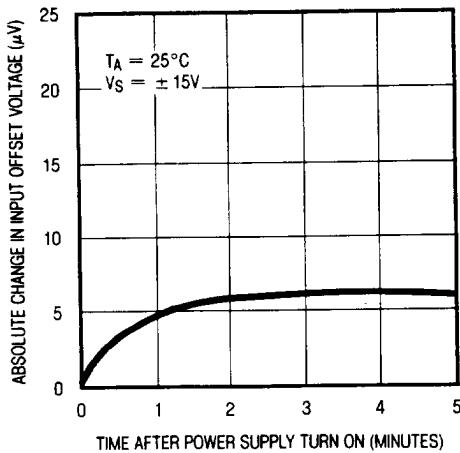

**Offset Voltage Change Due
to Thermal Shock**

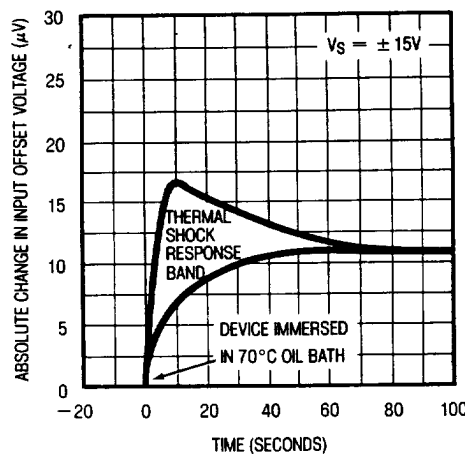

**Open-Loop Gain vs
Temperature**

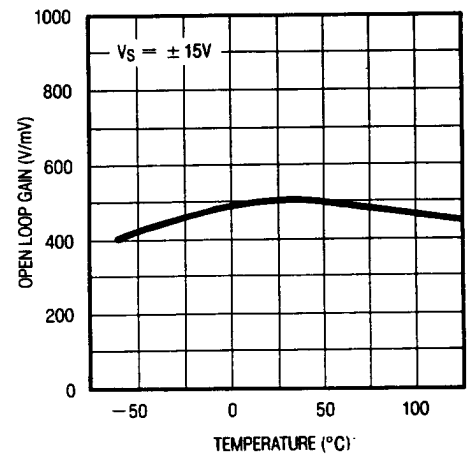

TYPICAL PERFORMANCE CHARACTERISTICS

Input Bias Current vs Temperature

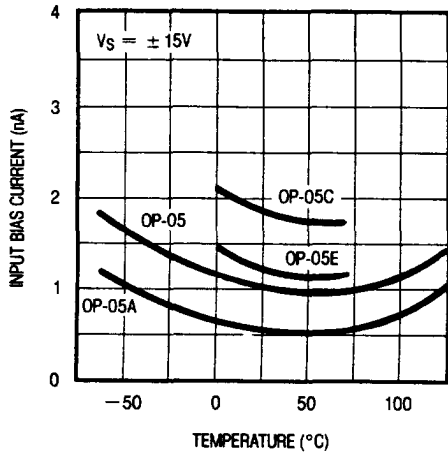

Input Offset Current vs Temperature

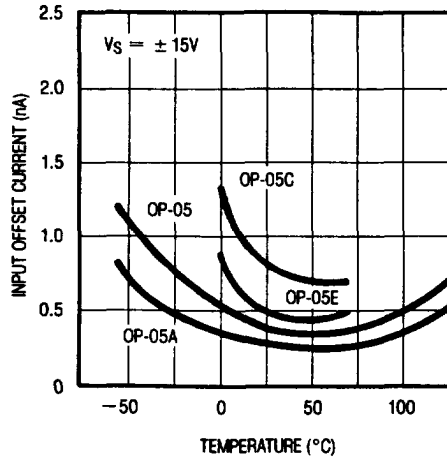

Input Bias Current vs Differential Input Voltage

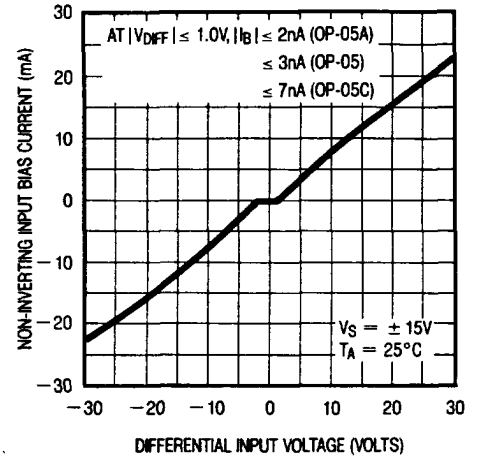

Maximum Error vs Source Resistance

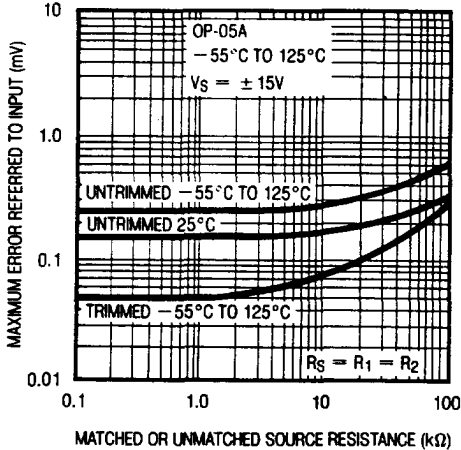

Maximum Error vs Source Resistance

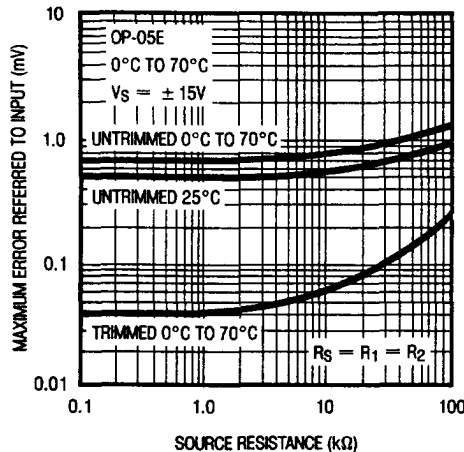

Maximum Error vs Source Resistance

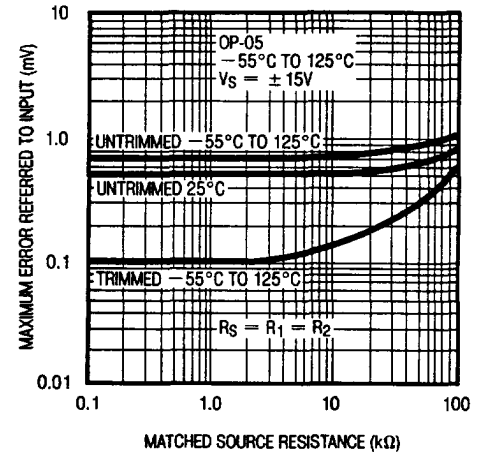

Output Voltage vs Load Resistance

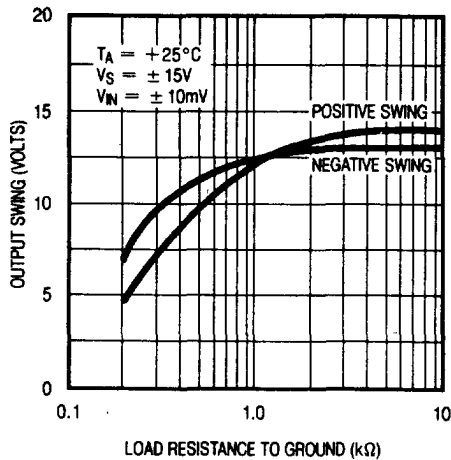

Power Consumption vs Power Supply

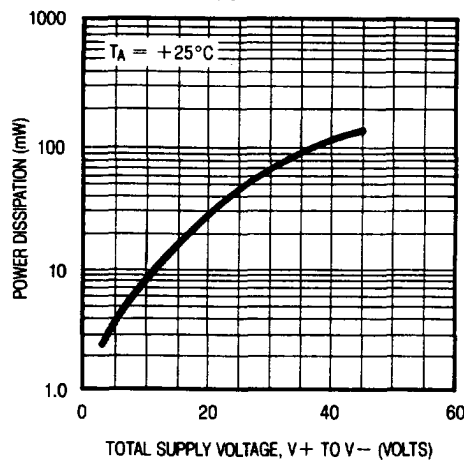

Output Short-Circuit Current vs Time

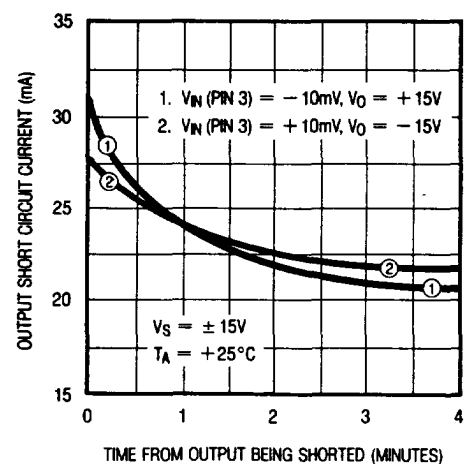

SCHEMATIC DIAGRAM

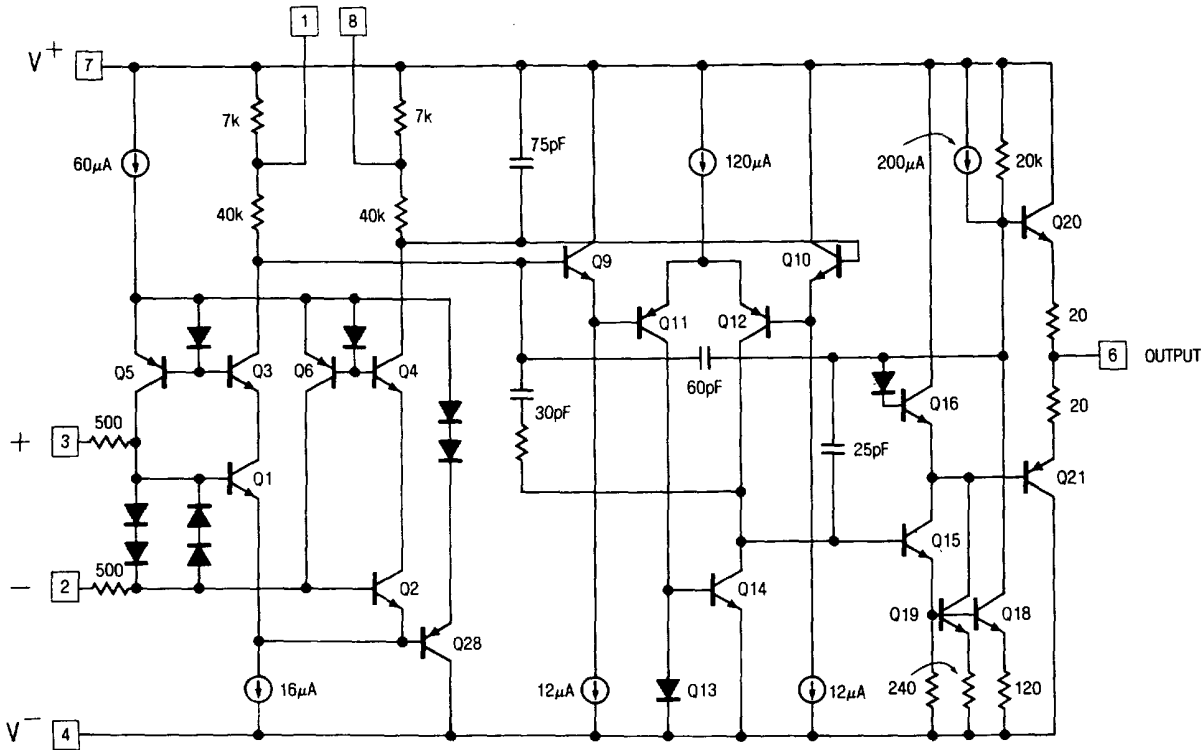

2

TEST CIRCUIT DIAGRAMS

Offset Voltage Test Circuit †

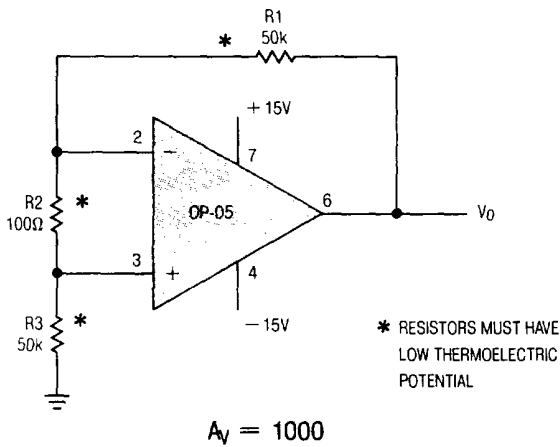

Offset Nulling and Low Frequency Noise Test Circuit

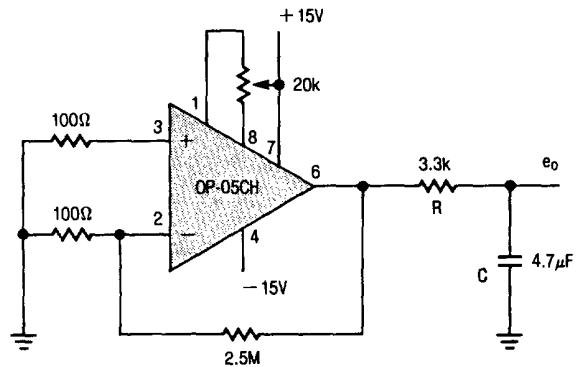

NOTES:

- 1) RC APPROXIMATELY 10Hz FILTER
- 2) OBSERVE OUTPUT FOR 10 SECONDS
 $A_v = 25000$

Application Tip

When the OP-05 is used as a replacement in 725, 108/108A, 308/308A applications, removal of external compensation is optional. For conventionally nulled 741 type applications, external trimming should be removed. Care should be taken to avoid thermocouple voltages caused by temperature variations between the input terminals or dissimilar metals.

† This circuit is also used as the burn-in configuration with supply voltages changed to $\pm 20V$, $R1 = R3 = 10k$, $R2 = 200\Omega$, $A_v = 100$.

TYPICAL APPLICATIONS

Precision Absolute Value Circuit

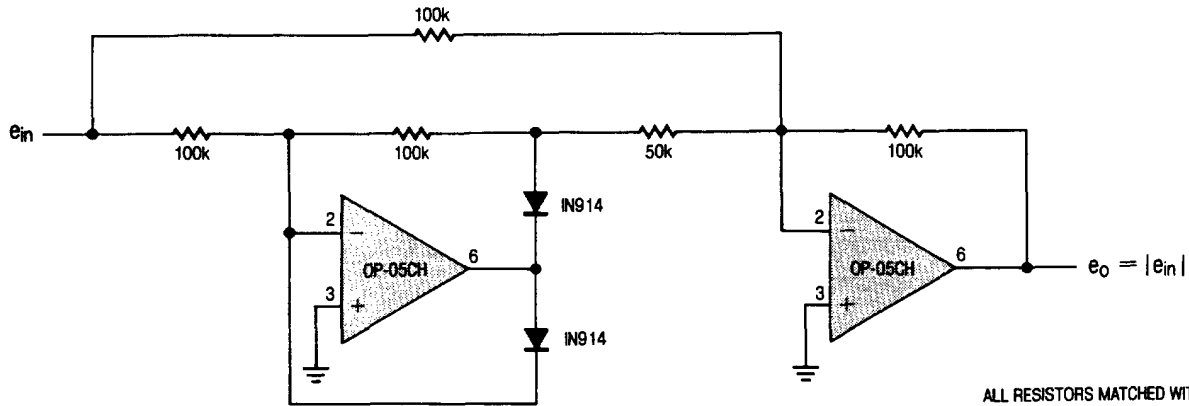

Two Op-Amp Instrumentation Amplifier

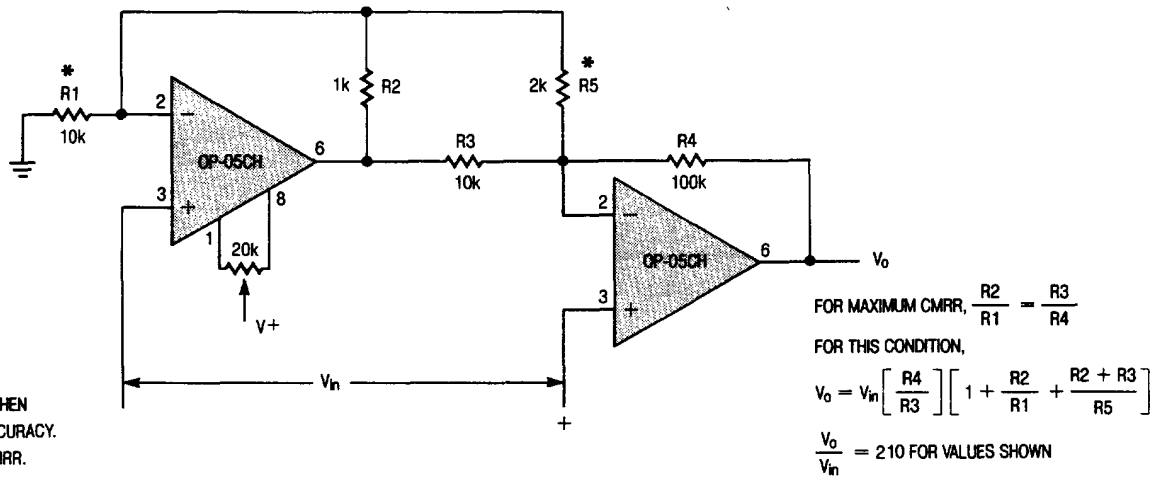

PACKAGE DESCRIPTION

H Package
Metal Can

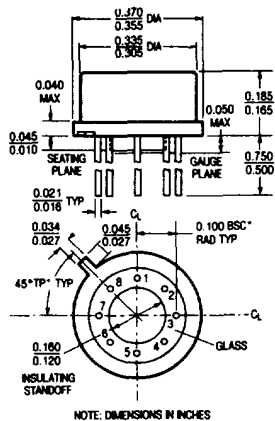

NOTE: DIMENSIONS IN INCHES

T_j max	θ_{ja}	θ_{jc}
150°C	150°C/W	45°C/W

J8 Package
8 Lead Hermetic Dip

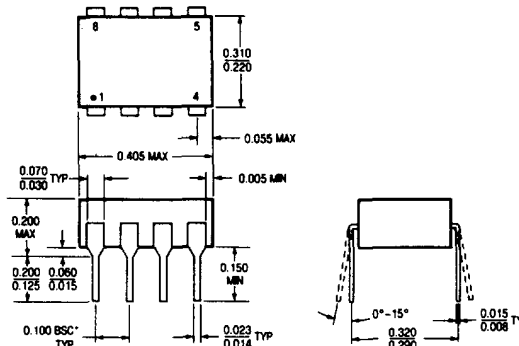

NOTE: DIMENSIONS IN INCHES UNLESS OTHERWISE NOTED.
*LEADS WITHIN 0.007 OF TRUE POSITION (TP) AT GAUGE PLANE

T_j max	θ_{ja}
150°C	100°C/W

N8 Package
8 Lead Plastic

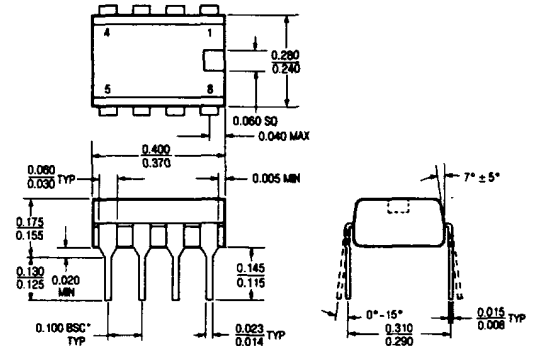

NOTE: DIMENSIONS IN INCHES UNLESS OTHERWISE NOTED.
*LEADS WITHIN 0.007 OF TRUE POSITION (TP) AT GAUGE PLANE.

T_j max	θ_{ja}
100°C	130°C/W