

HFBR-4531Z/4532Z/4533Z/4535Z

Crimless Connectors for Plastic Optical Fiber and Versatile Link



Data Sheet



Description

The HFBR-453xZ series connectors are an enhanced version of the HFBR-4501Z and HFBR-4503Z low-cost connectors for plastic optical fiber, which are compatible with Avago Technologies' versatile link series transmitters and receivers. The innovative design uses a simple, snap-together concept which eliminates the need for crimping. This connector not only saves the user labor and tool cost, but reduces the yield loss due to installation error.

The HFBR-453xZ series connectors are available in two styles: latching and non-latching. For a duplex connector, two non-latching simplex connectors can be snapped together. The connectors are made of a rugged, flame retardant plastic which is good for industrial and other harsh environments. The HFBR-453xZ series connectors are for use with Plastic Optical Fiber only.

The HFBR-453xZ Series of connectors are available in three colors; black, blue and grey. The ability to select colors to match Transmitters and Receivers makes it easier for the User to differentiate between fiber connections especially when there are a large number.

Features

- Requires No Crimp Ring or Crimping Tool
- Durable ULTEM® Plastic Material (UL File #E121562)
- Same Low Cost as HFBR-4501Z/4503Z Series Connectors
- Excellent Retention Force
- Symmetry in Nonlatching Connector Gives Simplex/Duplex Functionality with the Same Part

Applications

These connectors can be used for any application in which plastic optical fiber is used including:

- Industrial Control and Voltage Isolation
- Automotive Networks
- Proprietary System Interconnects
- Gaming Equipment
- Medical Equipment
- Telecommunications
- Datacommunications

ULTEM® is a registered trademark of the General Electric Corporation.

Termination Guide

Step-by-Step Plastic Cable Connectoring Instructions

The following step-by-step guide describes how to terminate plastic fiber optic cable. It is ideal for both field and factory installations. Connectors can be easily installed on cable ends with standard tools such as wire strippers and cutters.

Finishing the cable is accomplished with the Avago Technologies HFBR-4593Z Polishing Kit, consisting of a polishing fixture, 600 grit abrasive paper and 3 mm pink lapping film (3M Company, OC3-14). The connector can be used immediately after polishing.

The following materials are needed for plastic fiber termination:

1. Plastic optical fiber cable (Example: HFBR-RUD500Z)
2. Wire cutters or scissors
3. 16 gauge wire stripper (Example: Ideal Stripmaster type 45-092)
4. HFBR-4593Z polishing kit (optional)
5. Crimpless connectors

Step 1: Stripping the Fiber

The zip cord structure of the duplex cable permits easy separation of the channels. The channels should be separated a minimum of 100 mm (4 in) to a maximum of 150 mm (6 in) back from the ends to permit connectoring, polishing and cable end flexibility.

After cutting the cable to the desired length, strip off approximately 7 mm (0.3 in) of the outer jacket with the 16 gauge wire strippers.



When using the duplex connector arrangement, the separated duplex cable should be stripped to roughly equal lengths on each cable end.

For the non-latching version (HFBR-4531Z), the same connector is used for simplex and duplex arrangement. No crimping is necessary. The top half of the connector will snap into the ferrule half to secure the fiber.



Step 2: Putting on the Connector

Place the connector on each end of the fiber, and slide the connector down until the fiber jacket stops it. The fiber should protrude *no less* than 1.5 mm (0.06 in) from the end of the connector.

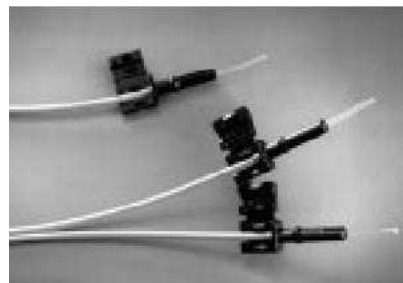

To install *simplex* connectors flip the top half of the connector over and snap it into the ferrule half (with your fingers). When the top half latches inside the body of the ferrule half, proper connector-to-cable attachment is achieved.

For *duplex* connector installation place one connector on top of the other, so that the top half of each connector is over the ferrule half of the opposite connector.



Manually press connectors together in the center of the arrangement. Then latch by pressing on the sides of each connector. As with the simplex version, connectors are secured when top halves latch into the ferrule halves.

Step 3: Trimming and Polishing

Any fiber in excess of 1.5 mm (0.06 in) protruding from the connector end should be cut off with wire cutters or scissors.

Insert the connector fully into the polishing fixture with the trimmed fiber protruding from the bottom of the fixture. This plastic polishing fixture can be used to polish two simplex connectors simultaneously or one duplex connector.

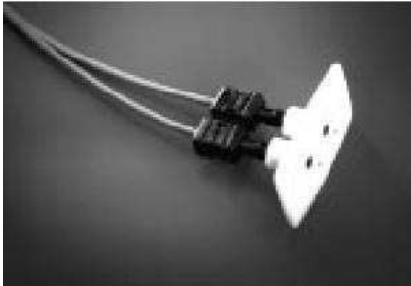

Note: The four dots on the bottom of the polishing fixture are wear indicators. Replace the polishing fixture when any dot is no longer visible.

Press the polishing tool down on the 600 grit abrasive paper. Polish the fiber using a figure eight pattern until the connector is flush with the bottom of the polishing fixture. Wipe the connector and fixture with a clean cloth or tissue.

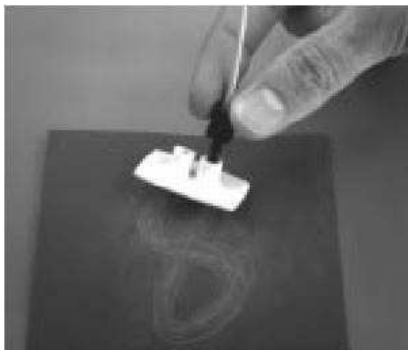

Step 4: Finishing

Place the flush connector and polishing fixture on the dull side of the 3 μ m pink lapping film and continue to polish the fiber in the same figure eight pattern for approximately 25 strokes. The fiber end should be flat, smooth and clean.

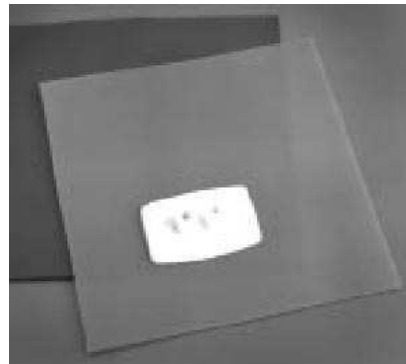

HFBR-4593Z Polishing Kit

Note: Use of the pink lapping film fine polishing step results in approximately 2 dB improvement in coupling performance of either a transmitter-receiver link or a bulk-head/splice over a 600 grit polish alone. This fine polish is comparable to the Avago Technologies factory polish. The fine polishing step may be omitted for short link lengths.

Crimpleless Connectors	Simplex	
	Non-Latching	Latching
Black	HFBR-4531Z	HFBR-4532Z
Blue	HFBR-4533Z	NA
Grey	HFBR-4535Z	NA

HFBR-4531Z/4532Z/4533Z/4535Z

Absolute Maximum Ratings

Parameter	Symbol	Min	Max	Units	Note
Storage Temperature	T_S	-40	+85	°C	1
Operating Temperature	T_O	-40	+85	°C	1
Installation Temperature	T_I	0	+70	°C	1

Connector Mechanical Characteristics

Parameter	Part Number	Symbol	Min	Typ	Units	Temp °C
Retention Force to HFBR-0501Z Series	HFBR-4531Z	F_{R-C}	3	8	N	+25
	HFBR-4532Z		47	80		
Retention Force to HFBR-0508Z Series	HFBR-4531Z		8	12		
Tensile Force, Connector to Cable	HFBR-4531Z	F_T	40	50		-40 to +85
	HFBR-4532Z					

Note:

1. Storage and operating temperatures refer to the ranges over which the connectors can be used when not subjected to mechanical stress. Installation temperature refers to the ranges over which connectors may be installed onto the fiber and over which connectors can be connected and disconnected from the transmitter and receiver modules.

Mechanical Dimensions

All dimensions are in inches and (millimeters).

HFBR-4531Z (Nonlatching):

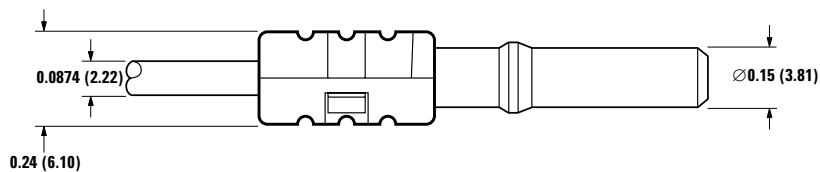
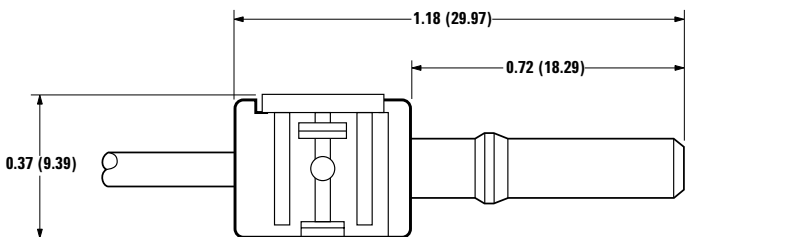

HFBR-4532Z (Latching):

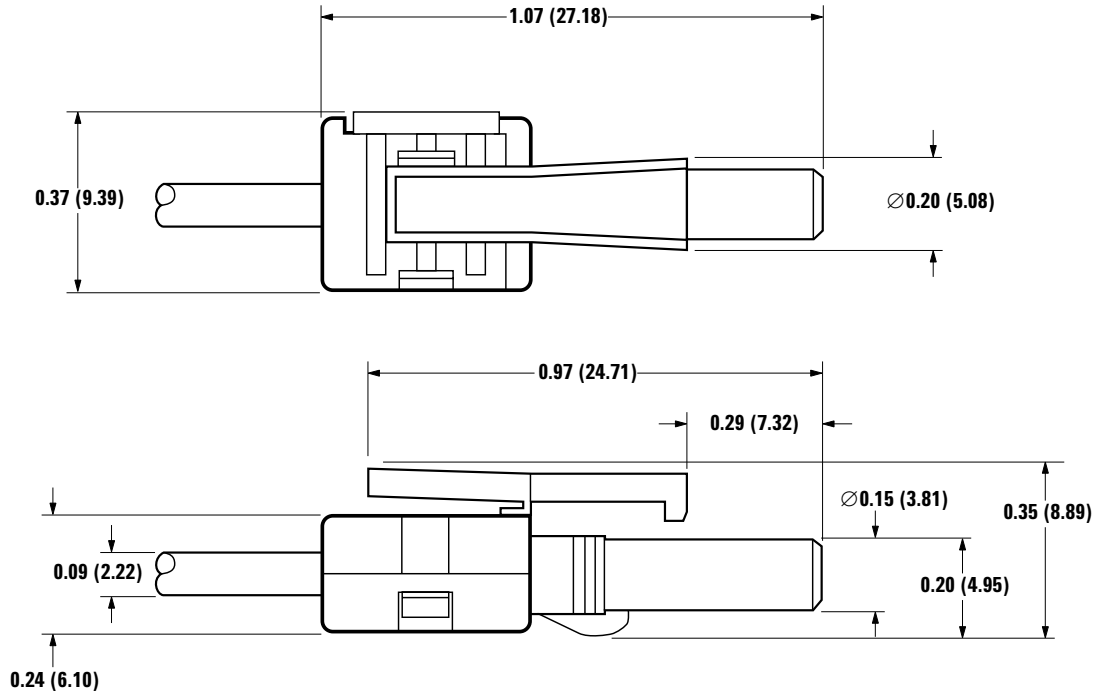

HFBR-4531Z in Duplex Configuration

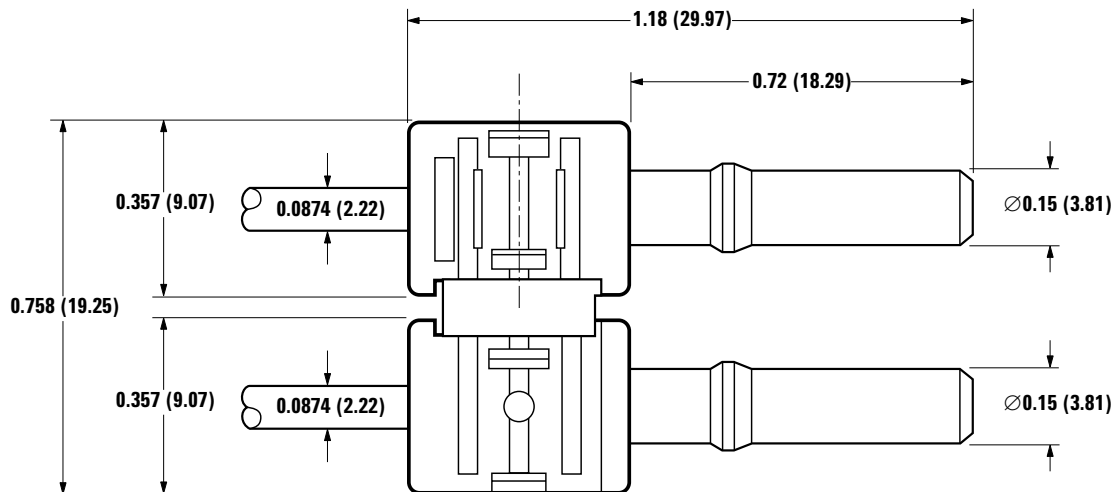

For product information and a complete list of distributors, please go to our web site: www.avagotech.com

Avago, Avago Technologies, and the A logo are trademarks of Avago Technologies, Limited in the United States and other countries. Data subject to change. Copyright © 2006 Avago Technologies Limited. All rights reserved. AV02-0460EN - June 4, 2007

