





Heyco® Screw to Tab Terminal Blocks

Screw to (3) Tabs Flame Retardant and UL 94V-0

WIRE SIZE AWG	mm ²	AMPS	POLES	PART NO. White	DESCRIPTION	Screws (Metric)	PART DIMENSIONS											
							A		B		C		D		E		F	
							in.	mm.	in.	mm.	in.	mm.	in.	mm.	in.	mm.	in.	mm.
				9450	ATB-3P FR													
8-18	10	40	3	9451	ATB-3P FR w/ Ground	M5,0	3.19	81,0	.59	15,0	1.00	25,4	2.60	66,0	.41	10,4	1.48	37,5
8-18	10	40	4	9452	ATB-4P FR	M5,0	3.90	99,0	.59	15,0	1.00	25,4	3.31	84,0	.41	10,4	1.48	37,5
				9454*	ATB-6P FR													
8-18	10	40	6	9455*	ATB-6P FR w/ Ground	M5,0	5.31	135,0	.59	15,0	1.00	25,4	4.72	120,0	.41	10,4	1.48	37,5
				9456	Jumper for Screw to Tab Poles													
				9457	Ground for Screw to Tab TB													

Standard color flame retardant white.

* Includes three jumpers. To order additional jumpers, see part 9456.

- Three .250" by .031" (6,3 by 0,8 mm) tabs per pole.
- ATB-3P poles are marked 1, 2, and .
- ATB-4P poles are marked 1, 2, 3 and .
- ATB-6P poles are marked 1, 2, 3, 4, 5 and .
- All sizes are rated at 600 volts (450 volts in Europe).
- Self-grounding version is available. Identical to the base parts except that an extension on the grounding pole makes direct contact with the panel. The extension is secured with two self-tapping screws.
- Ground contact (**Part No. 9457**)— Grounds terminal block to the panel. May be ordered separately or with the listed Appliance Terminal Blocks.
- Jumper (**Part No. 9456**)— To connect terminal block poles. For use with Heyco's Screw to Tab terminal blocks.

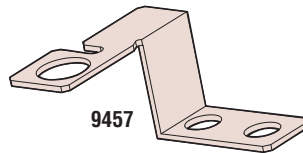
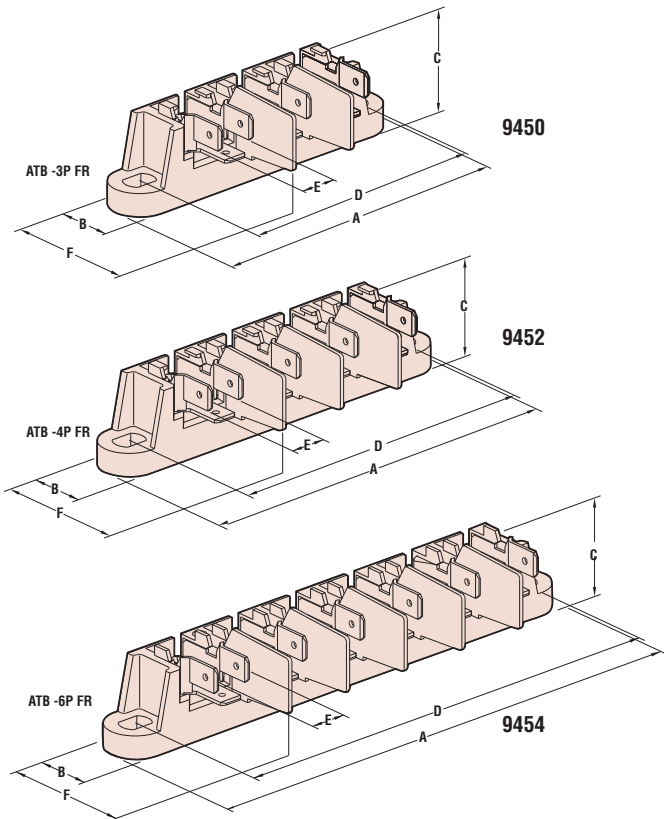

GROUND CONTACT

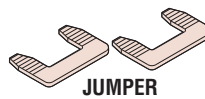

JUMPER

Materials	6/6 Nylon and galvanized steel
Certifications	 Recognized under Component Program of Underwriters' Laboratories to both Canadian and US requirements File E197025
Flammability Rating	94V-0
Temperature Rating	302°F (150°C)

Quick Specs