

Compact performance filter

FN 9675

- Current ratings from 3 to 16A
- Economic high-performance filter
- Screw or fast-on connections
- Nennströme von 3 bis 16A
- Wirtschaftliches Hochleistungsfilter
- Schraub- oder Steckanschlüsse
- Courants de service de 3 à 16A
- Filtre haute performance peu onéreux
- Connexions par vis ou fast-on



Filter selection table

Choose the family FN xxx with the required current rating and features, and add /?? to determine input/output (line/load) connection style. Example: FN 9675-3/06 is a 3A filter with fast-on connections.

Approvals



Family	Connections	Current ratings at 40°C (25°) A	Inductance L mH	Capacitance Cx/Cx1 nF	Housing	Weight g
FN 9675 -3 /??		3 (3.5)	18	680/680	K21	270
FN 9675 -6 /??		6 (6.9)	3	680/680	K21	270
FN 9675 -16 /??		16 (18.4)	10.2	1000/1000	L2	850
FN 9676 -16 /??		16 (18.4)	10.2	1000/1000	L2	1050

Additional specifications

Filter type	Capacitance Cy/Cy1 nF	Res. R MΩ	Maximum leakage μA/phase	Maximum operating voltage		Operating frequency Hz	Hipot test voltage	
				VAC	Hz		PN→E VAC	P→N VDC
FN 9675 types	4.7/-	0.47	410	250	50/60	DC to 400	2000	1700
FN 9676 types	6.8/15	0.47	1900	250	50/60	DC to 400	2000	1700

MTBF at 40°C, 230V, per Mil-HB-217F: 280,000 hours (FN 9675); 400,000 hours (FN 9676).

Electrical schematics

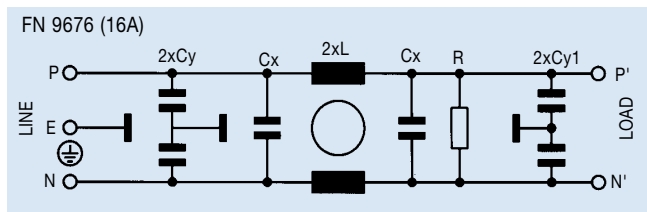
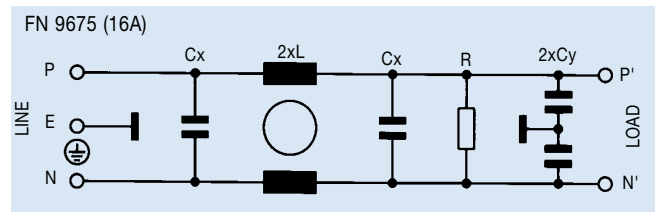
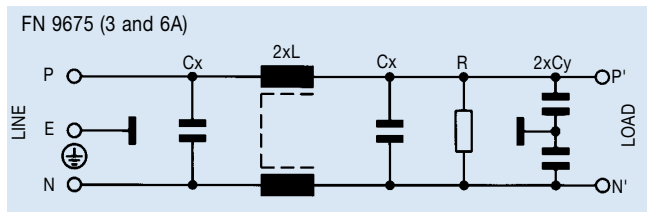

See tables for component values.

FN 9675 insertion loss

Per CISPR 17; A = 50Ω/50Ω sym, B = 50Ω/50Ω asym, C = 0.1Ω/100Ω sym, D = 100Ω/0.1Ω sym

3 amp types

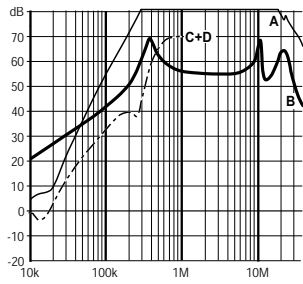

6 amp types

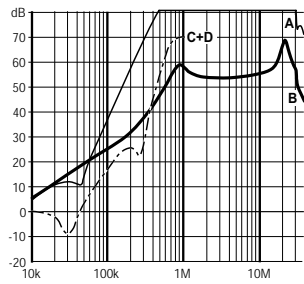

16 amp FN 9675

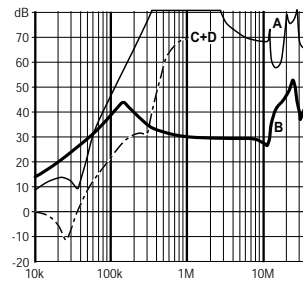

16 amp FN 9676

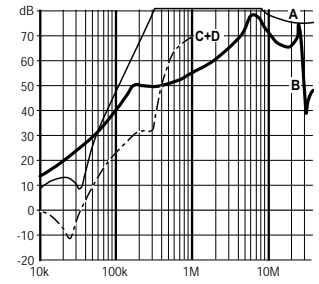

Mechanical data

	FN 9675 -3-6	FN 967x -16	Tol.* mm
	K21	L2	
A	85	105	± 0.5
B	54	99.5 ± 1	± 0.5
C	40	57	± 1
D	65	84.5	± 1
E		79	± 0.5
F	75	95	± 0.2
G		51	± 0.1
J	27	40	± 0.5
K	12	11	± 0.5
L	29.5	19	± 0.5
M	5.3	4.4	± 0.1
N	6.3	6	± 0.1

* Measurements share this common tolerance unless otherwise stated.

Front view

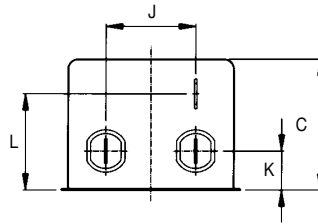

Housing K21

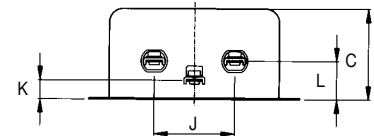

Housing L2

Top view

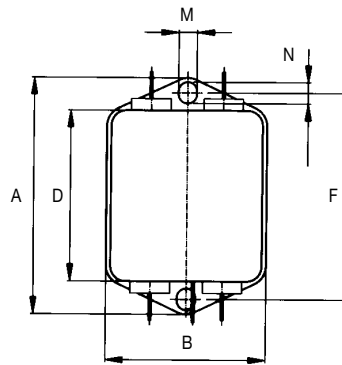

Housing K21

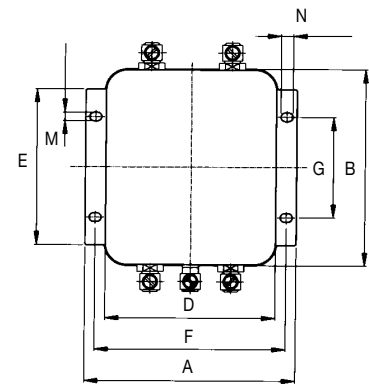

Housing L2

All dimensions in mm; 1 inch = 25.4 mm