

FIN1532 5V LVDS 4-Bit High Speed Differential Receiver

General Description

This quad receiver is designed for high speed interconnects utilizing Low Voltage Differential Signaling (LVDS) technology. The receiver translates LVDS levels, with a typical differential input threshold of 100 mV, to LVTTTL signal levels. LVDS provides low EMI at ultra low power dissipation even at high frequencies. This device is ideal for high speed transfer of clock and data.

The FIN1532 can be paired with its companion driver, the FIN1531, or any other LVDS driver.

Features

- Greater than 400Mbps data rate
- 5V power supply operation
- 0.5 ns maximum differential pulse skew
- 3 ns maximum propagation delay
- Low power dissipation
- Power-Off protection for inputs and outputs
- Fail safe protection for open-circuit, shorted and terminated receiver inputs
- Meets or exceeds the TIA/EIA-644 LVDS standard
- Pin compatible with equivalent RS-422 and PECL devices
- 16-Lead SOIC and TSSOP packages save space

Ordering Code:

Order Number	Package Number	Package Description
FIN1532M	M16A	16-Lead Small Outline Integrated Circuit (SOIC), JEDEC MS-012, 0.150" Narrow
FIN1532MTC	MTC16	16-Lead Thin Shrink Small Outline Package (TSSOP), JEDEC MO-153, 4.4mm Wide

Devices also available in Tape and Reel. Specify by appending the suffix letter "X" to the ordering code.

Pin Descriptions

Pin Name	Description
R _{OUT1} , R _{OUT2} , R _{OUT3} , R _{OUT4}	LVTTTL Data Outputs
R _{IN1+} , R _{IN2+} , R _{IN3+} , R _{IN4+}	Non-inverting LVDS Inputs
R _{IN1-} , R _{IN2-} , R _{IN3-} , R _{IN4-}	Inverting LVDS Inputs
EN	Driver Enable Pin
$\overline{\text{EN}}$	Inverting Driver Enable Pin
V _{CC}	Power Supply
GND	Ground

Connection Diagram

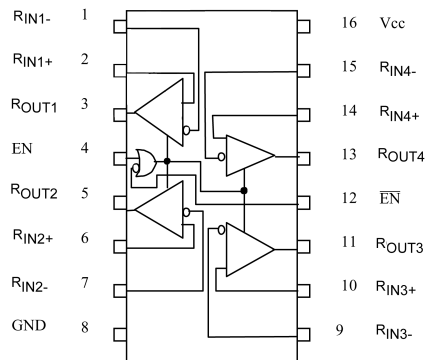

Top View

Function Table

Input			Outputs	
EN	$\overline{\text{EN}}$	R _{IN+}	R _{IN-}	R _{OUT}
H	X	H	L	H
H	X	L	H	L
H	X	Fail Safe Condition		H
X	L	H	L	H
X	L	L	H	L
X	L	Fail Safe Condition		H
L	H	X		Z

H = HIGH Logic Level L = LOW Logic Level X = Don't Care
Z = High Impedance Fail Safe = Open, Shorted, Terminated

Absolute Maximum Ratings (Note 1)

Supply Voltage (V_{CC})	-0.5 V to +6 V
DC Input Voltage (V_{IN})	
Enable Inputs	-0.5 V to +6 V
Receiver Inputs	-0.5 V to +6 V
DC Output Voltage (V_{OUT})	-0.5 V to +6 V
DC Output Current (I_O)	16 mA
Storage Temperature Range (T_{STG})	-65°C to +150°C
Max Junction Temperature (T_J)	150°C
Lead Temperature (T_L)	
(Soldering, 10 seconds)	260°C
ESD (Human Body Model)	≥ 8000 V
ESD (Machine Model)	≥ 300 V

Recommended Operating Conditions

Supply Voltage (V_{CC})	4.5 V to 5.5 V
Input Voltage (V_{IN})	
Enable Inputs	0 to V_{CC}
Receiver Inputs	0 to 2.4 V
Magnitude of Differential Voltage ($ V_{ID} $)	100 mV to 600 mV
Common-mode Input Voltage (V_{IC})	$ V_{ID} /2$ to $(2.4 - V_{ID})/2$
Operating Temperature (T_A)	-40°C to +85°C

Note 1: The "Absolute Maximum Ratings" are those values beyond which damage to the device may occur. The databook specifications should be met, without exception, to ensure that the system design is reliable over its power supply, temperature and output/input loading variables. Fairchild does not recommend operation of circuits outside databook specification.

DC Electrical Characteristics

Over supply voltage and operating temperature ranges, unless otherwise specified

Symbol	Parameter	Test Conditions	Min	Typ (Note 2)	Max	Units
V_{TH}	Differential Input Threshold HIGH	$V_{IC} = +1.2V$, See Figure 1			100	mV
V_{TL}	Differential Input Threshold LOW	$V_{IC} = +1.2V$, See Figure 1	-100			mV
I_{IN}	Input Current EN or \overline{EN}	$V_{IN} = 0V$ or V_{CC} , $V_{CC} = 5.5$ or $0V$			±20	μA
	Input Current Receiver Inputs	$V_{IN} = 0V$ or 2.4 V, $V_{CC} = 5.5$ or $0V$			±20	μA
V_{IH}	Input High Voltage (EN or \overline{EN})		2.0		V_{CC}	V
V_{IL}	Input Low Voltage (EN or \overline{EN})		GND		0.8	V
V_{OH}	Output HIGH Voltage	$I_{OH} = -100 \mu A$	$V_{CC} - 0.2$	4.98		V
		$I_{OH} = -8 \text{ mA}$	3.8	4.68		
V_{OL}	Output LOW Voltage	$I_{OH} = 100 \mu A$		0.01	0.2	V
		$I_{OL} = 8 \text{ mA}$		0.22	0.5	
V_{IK}	Input Clamp Voltage	$I_{IK} = -18 \text{ mA}$	-1.5	-0.8		V
I_{OZ}	Disabled Output Leakage Current	EN = 0.8 and $\overline{EN} = 2V$, $V_{OUT} = 5.5V$ or $0V$			±20	μA
$I_{O(OFF)}$	Power-OFF Output Current	$V_{OUT} = 0V$ or 5.5V, $V_{CC} = 0V$			50	μA
I_{OS}	Output Short Circuit Test	Receiver Enabled, $V_{OUT} = 0V$ (one output shorted at a time)	-15		-100	mA
I_{CCZ}	Disabled Power Supply Current	Receiver Disabled		1.2	5	mA
I_{CC}	Power Supply Current	Receiver Enabled, $R_{IN+} = 1V$ and $R_{IN-} = 1.4V$		11	17	mA
		Receiver Enabled, $R_{IN+} = 1.4V$ and $R_{IN-} = 1V$		15	23	
$I_{PU/PD}$	Output Power Up/Power Down High Z Leakage Current	$V_{CC} = 0V$ to 2.0V			±20	μA
C_{IN}	Input Capacitance			5.5		pF
C_{OUT}	Output Capacitance			4.5		pF

Note 2: All typical values are at $T_A = 25^\circ C$ and with $V_{CC} = 5V$.

AC Electrical Characteristics

Over supply voltage and operating temperature ranges, unless otherwise specified

Symbol	Parameter	Test Conditions	Min	Typ (Note 3)	Max	Units	
t_{PLH}	Propagation Delay LOW-to-HIGH	V _{ID} = 400 mV, C _L = 10 pF, R _L = 1kΩ See Figure 1 and Figure 2	1.0	2.0	3.0	ns	
t_{PHL}	Propagation Delay HIGH-to-LOW		1.0	2.0	3.0	ns	
t_{TLH}	Output Rise Time (20% to 80%)			1.3		ns	
t_{THL}	Output Fall Time (80% to 20%)			1.1		ns	
$t_{SK(P)}$	Pulse Skew t _{PLH} - t _{PHL}				0.2	0.5	ns
$t_{SK(LH)}$	Channel-to-Channel Skew (Note 4)				0.1	0.3	ns
$t_{SK(HL)}$	Channel-to-Channel Skew (Note 4)						ns
$t_{SK(PP)}$	Part-to-Part Skew (Note 5)				1.0	ns	
f_{MAX}	Maximum Operating Frequency (Note 6)	R _L = 1kΩ, C _L = 10 pF, See Figure 1 and Figure 2	200	260		MHz	
t_{ZH}	LVTTL Output Enable Time from Z to HIGH	R _L = 1kΩ, C _L = 10 pF, See Figure 3 and Figure 4		8	12.0	ns	
t_{ZL}	LVTTL Output Enable Time from Z to LOW			8	12.0	ns	
t_{HZ}	LVTTL Output Disable Time from HIGH to Z			4	8.0	ns	
t_{LZ}	LVTTL Output Disable Time from LOW to Z			4	8.0	ns	

Note 3: All typical values are at T_A = 25°C and with V_{CC} = 5V.

Note 4: t_{SK(LH)}, t_{SK(HL)} is the skew between specified outputs of a single device when the outputs have identical loads and are switching in the same direction.

Note 5: t_{SK(PP)} is the magnitude of the difference in propagation delay times between any specified terminals of two devices switching in the same direction (either LOW-to-HIGH or HIGH-to-LOW) when both devices operate with the same supply voltage, same temperature, and have identical test circuits.

Note 6: f_{MAX} Criteria: Input t_R = t_F < 1 ns, V_{ID} = 300 mV, (1.05V to 1.35V pp), 50% duty cycle; Output duty cycle 40% to 60%, V_{OL} < 0.5V, V_{OH} > 2.4V. All channels switching in phase.

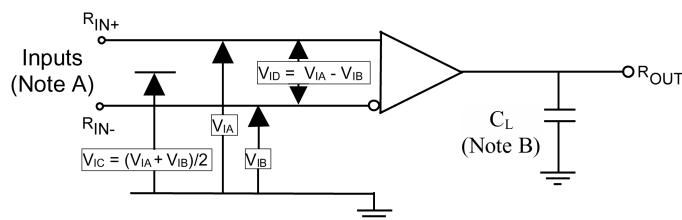

Note A: All input pulses have frequency = 10 MHz, t_R or t_F = 1 ns

Note B: C_L includes all probe and jig capacitances

FIGURE 1. Differential Receiver Voltage Definitions and Propagation Delay

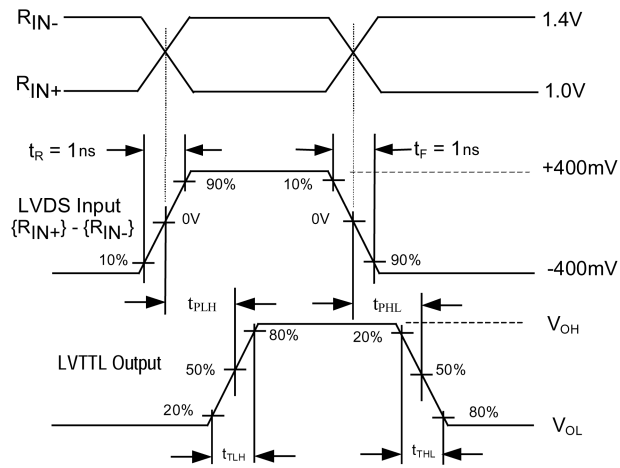

FIGURE 2. LVDS Input to LVTTTL Output AC Waveforms

Test Circuit for LVTTTL Outputs

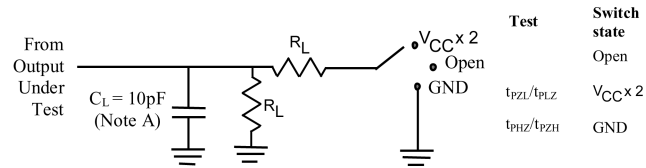
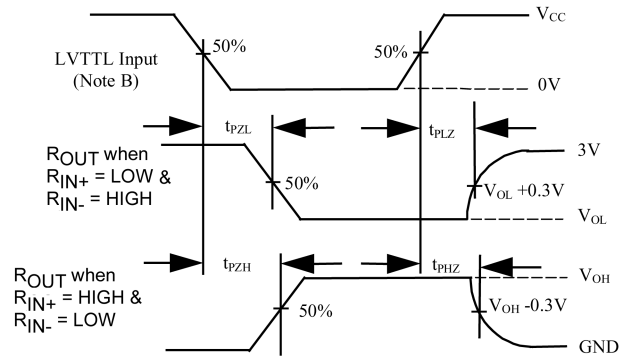

FIGURE 3. AC Loading Circuit for LVTTTL Outputs

Voltage Waveforms Enable and Disable Times



Note A: C_L includes probes and jig capacitance

Note B: All LVTTTL input pulses have the following characteristics: Frequency = 10 MHz, t_R or t_F = 2 ns

FIGURE 4. LVTTTL Outputs Test Circuit and AC Waveforms

Physical Dimensions inches (millimeters) unless otherwise noted

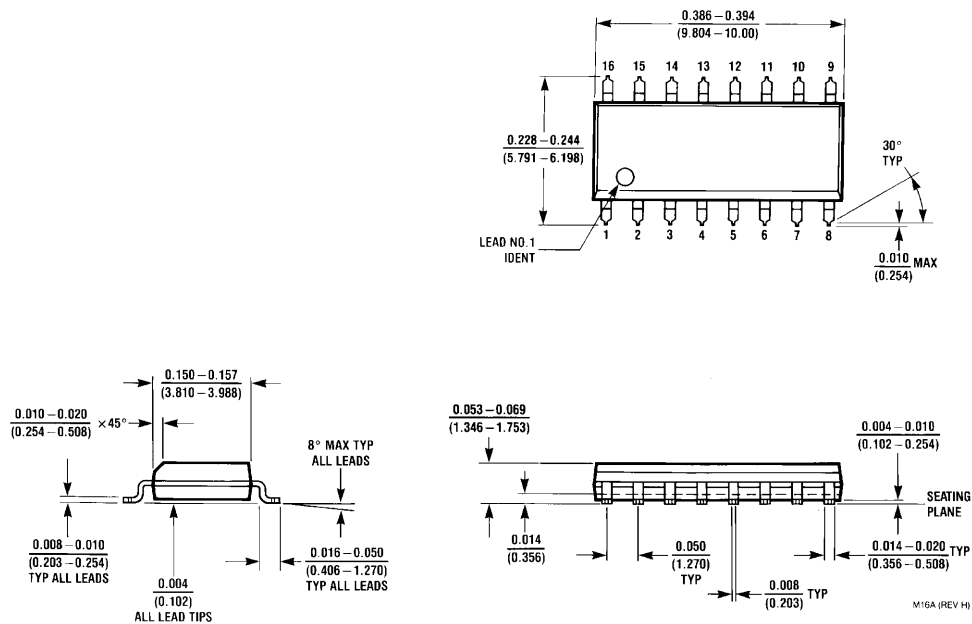

**16-Lead Small Outline Integrated Circuit (SOIC), JEDEC MS-012, 0.150" Narrow
Package Number M16A**

Physical Dimensions inches (millimeters) unless otherwise noted (Continued)

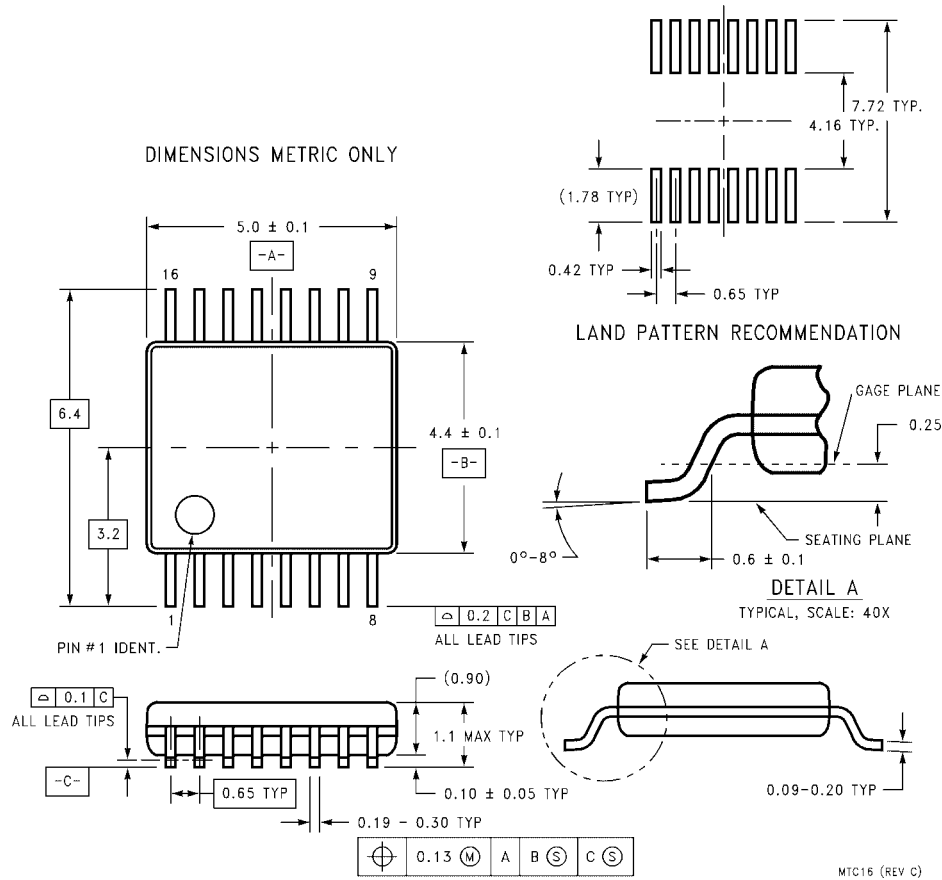

**16-Lead Thin Shrink Small Outline Package (TSSOP), JEDEC MO-153, 4.4mm Wide
Package Number MTC16**

Fairchild does not assume any responsibility for use of any circuitry described, no circuit patent licenses are implied and Fairchild reserves the right at any time without notice to change said circuitry and specifications.

LIFE SUPPORT POLICY

FAIRCHILD'S PRODUCTS ARE NOT AUTHORIZED FOR USE AS CRITICAL COMPONENTS IN LIFE SUPPORT DEVICES OR SYSTEMS WITHOUT THE EXPRESS WRITTEN APPROVAL OF THE PRESIDENT OF FAIRCHILD SEMICONDUCTOR CORPORATION. As used herein:

1. Life support devices or systems are devices or systems which, (a) are intended for surgical implant into the body, or (b) support or sustain life, and (c) whose failure to perform when properly used in accordance with instructions for use provided in the labeling, can be reasonably expected to result in a significant injury to the user.
2. A critical component in any component of a life support device or system whose failure to perform can be reasonably expected to cause the failure of the life support device or system, or to affect its safety or effectiveness.

www.fairchildsemi.com