

74VHC245

Octal Bidirectional Transceiver with 3-STATE Outputs

General Description

The VHC245 is an advanced high speed CMOS octal bus transceiver fabricated with silicon gate CMOS technology. It achieves high speed operation similar to equivalent Bipolar Schottky TTL while maintaining the CMOS low power dissipation. The VHC245 is intended for bidirectional asynchronous communication between data busses. The direction of data transmission is determined by the level of the T/R input. The enable input can be used to disable the device so that the busses are effectively isolated. All inputs are equipped with protection circuits against static discharge.

Features

- High Speed: $t_{PD} = 4.0$ ns (typ) at $V_{CC} = 5$ V
- High Noise Immunity: $V_{NIH} = V_{NIL} = 28\% V_{CC}$ (Min)
- Power Down Protection is provided on all inputs
- Low Noise: $V_{OLP} = 0.9$ V (typ)
- Low Power Dissipation:
 $I_{CC} = 4$ μ A (Max) @ $T_A = 25^\circ$ C
- Pin and Function Compatible with 74HC245

Ordering Code:

Order Number	Package Number	Package Description
74VHC245M	M20B	20-Lead Small Outline Integrated Circuit (SOIC), JEDEC MS-013, 0.300" Wide
74VHC245SJ	M20D	Pb-Free 20-Lead Small Outline Package (SOP), EIAJ TYPE II, 5.3mm Wide
74VHC245MTC	MTC20	20-Lead Thin Shrink Small Outline Package (TSSOP), JEDEC MO-153, 4.4mm Wide
74VHC245N	N20A	20-Lead Plastic Dual-In-Line Package (PDIP), JEDEC MS-001, 0.300" Wide

Surface mount packages are also available on Tape and Reel. Specify by appending the suffix letter "X" to the ordering code.
Pb-Free package per JEDEC J-STD-020B.

Logic Symbol

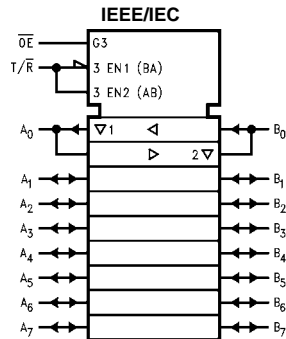

Connection Diagram

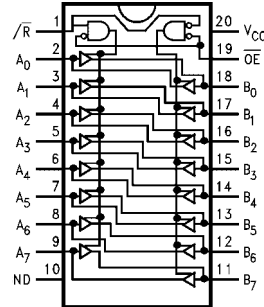

Pin Description

Pin Names	Description
\overline{OE}	Output Enable Input
T/\overline{R}	Transmit/Receive Input
A_0 - A_7	Side A Inputs or 3-STATE Outputs
B_0 - B_7	Side B Inputs or 3-STATE Outputs

Truth Table

Inputs		Outputs
\overline{OE}	T/\overline{R}	
L	L	Bus B Data to Bus A
L	H	Bus A Data to Bus B
H	X	HIGH-Z State

H = HIGH Voltage Level L = LOW Voltage Level X = Immaterial
Any unused bus terminals during HIGH-Z State must be held HIGH or LOW.

Absolute Maximum Ratings (Note 1)

Supply Voltage (V_{CC})	-0.5V to +7.0V
DC Input Voltage (V_{IN}) ($\overline{T/R}$, \overline{OE})	-0.5V to 7.0V
DC Output Voltage (V_{OUT})	-0.5V to $V_{CC} + 0.5V$
Input Diode Current (I_{IK}) ($\overline{T/R}$, \overline{OE})	-20 mA
Output Diode Current (I_{OK})	± 20 mA
DC Output Current (I_{OUT})	± 25 mA
DC V_{CC}/GND Current (I_{CC})	± 75 mA
Storage Temperature (T_{STG})	-65°C to +150°C
Lead Temperature (T_L) (Soldering, 10 seconds)	260°C

Recommended Operating Conditions (Note 2)

Supply Voltage (V_{CC})	2.0V to 5.5V
Input Voltage (V_{IN}) ($\overline{T/R}$, \overline{OE})	0V to 5.5V
Output Voltage (V_{OUT})	0V to V_{CC}
Operating Temperature (T_{OPR})	-40°C to +85°C
Input Rise and Fall Time (t_r , t_f)	
$V_{CC} = 3.3V \pm 0.3V$	0 ~ 100 ns/V
$V_{CC} = 5.0V \pm 0.5V$	0 ~ 20 ns/V

Note 1: Absolute Maximum Ratings are values beyond which the device may be damaged or have its useful life impaired. The databook specifications should be met, without exception, to ensure that the system design is reliable over its power supply, temperature, and output/input loading variables. Fairchild does not recommend operation outside databook specifications.

Note 2: Unused inputs or I/O pins must be held HIGH or LOW. They may not float.

DC Electrical Characteristics

Symbol	Parameter	V_{CC} (V)	$T_A = 25^\circ\text{C}$			$T_A = -40^\circ\text{C to } +85^\circ\text{C}$		Units	Conditions
			Min	Typ	Max	Min	Max		
V_{IH}	HIGH Level Input Voltage	2.0	1.50			1.50	V		
		3.0 – 5.5	0.7 V_{CC}			0.7 V_{CC}			
V_{IL}	LOW Level Input Voltage	2.0		0.50		0.50	V		
		3.0 – 5.5		0.3 V_{CC}		0.3 V_{CC}			
V_{OH}	HIGH Level Output Voltage	2.0	1.9	2.0		1.9	V	$V_{IN} = V_{IH}$ or V_{IL}	
		3.0	2.9	3.0		2.9			
		4.5	4.4	4.5		4.4			
		3.0	2.58		2.48				
V_{OL}	LOW Level Output Voltage	2.0		0.0	0.1	0.1	V	$V_{IN} = V_{IH}$ or V_{IL}	
		3.0		0.0	0.1	0.1			
		4.5		0.0	0.1	0.1			
		3.0		0.36	0.44	0.44			
I_{OZ}	3-STATE Output Off-State Current	5.5		± 0.25		± 2.5	μA	$V_{IN} = V_{CC}$ or GND $V_{OUT} = V_{CC}$ or GND $V_{IN} \overline{OE} = V_{IH}$ or V_{IL}	
I_{IN} ($\overline{T/R}$, \overline{OE})	Input Leakage Current	0 – 5.5		± 0.1		± 1.0	μA	$V_{IN} = 5.5V$ or GND	
I_{CC}	Quiescent Supply Current	5.5		4.0		40.0	μA	$V_{IN} = V_{CC}$ or GND	

Noise Characteristics									
Symbol	Parameter	V _{CC} (V)	T _A = 25°C		Units	Conditions			
			Typ	Limits					
V _{OLP} (Note 3)	Quiet Output Maximum Dynamic V _{OL}	5.0	0.9	1.2	V	C _L = 50 pF			
V _{OLV} (Note 3)	Quiet Output Minimum Dynamic V _{OL}	5.0	-0.9	-1.2	V	C _L = 50 pF			
V _{IHD} (Note 3)	Minimum HIGH Level Dynamic Input Voltage	5.0		3.5	V	C _L = 50 pF			
V _{ILD} (Note 3)	Maximum LOW Level Dynamic Input Voltage	5.0		1.5	V	C _L = 50 pF			
Note 3: Parameter guaranteed by design.									
AC Electrical Characteristics									
Symbol	Parameter	V _{CC} (V)	T _A = 25°C			T _A = -40°C to +85°C		Units	Conditions
			Min	Typ	Max	Min	Max		
t _{PLH}	Propagation Delay	3.3 ± 0.3		5.8	8.4	1.0	10.0	ns	C _L = 15 pF
t _{PHL}	Time	5.0 ± 0.5		8.3	11.9	1.0	13.5		C _L = 50 pF
				4.0	5.5	1.0	6.5	ns	C _L = 15 pF
				5.5	7.5	1.0	8.5		C _L = 50 pF
t _{PZL}	3-STATE Output	3.3 ± 0.3		8.5	13.2	1.0	15.5	ns	C _L = 15 pF
t _{PZH}	Enable Time	5.0 ± 0.5		11.0	16.7	1.0	19.0		C _L = 50 pF
				5.8	8.5	1.0	10.0	ns	C _L = 15 pF
				7.3	10.6	1.0	12.0		C _L = 50 pF
t _{PLZ}	3-STATE Output	3.3 ± 0.3		11.5	15.8	1.0	18.0	ns	C _L = 50 pF
t _{PHZ}	Disable Time	5.0 ± 0.5		7.0	9.7	1.0	11.0		C _L = 50 pF
t _{OSLH}	Output to Output	3.3 ± 0.3			1.5		1.5	ns	(Note 4)
t _{OSHL}	Skew	5.0 ± 0.5			1.0		1.0		C _L = 50 pF
C _{IN} (T/R, OE)	Input Capacitance			4	10		10	pF	V _{CC} = Open
C _{I/O}	Output Capacitance			8				pF	V _{CC} = 5.0V
C _{PD}	Power Dissipation Capacitance			21				pF	(Note 5)
<p>Note 4: Parameter guaranteed by design. t_{OSLH} = t_{PLH} max - t_{PLH} min ; t_{OSHL} = t_{PHL} max - t_{PHL} min </p> <p>Note 5: C_{PD} is defined as the value of the internal equivalent capacitance which is calculated from the operating current consumption without load. Average operating current can be obtained by the equation: I_{CC} (opr.) = C_{PD} * f_N + I_{CC}/8 (per Bit).</p>									

Physical Dimensions inches (millimeters) unless otherwise noted

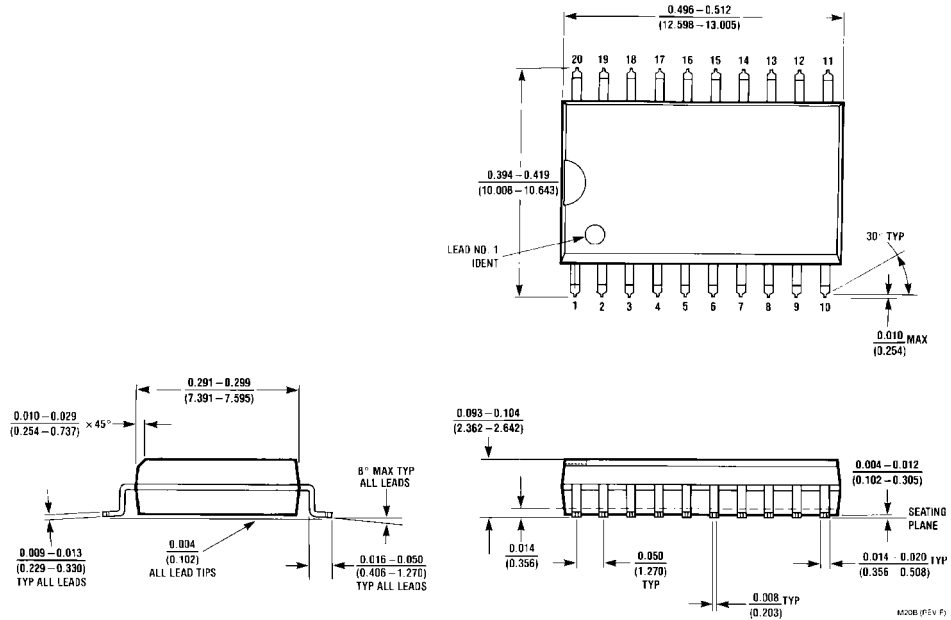

20-Lead Small Outline Integrated Circuit (SOIC), JEDEC MS-013, 0.300" Wide Package Number M20B

Physical Dimensions inches (millimeters) unless otherwise noted (Continued)



LAND PATTERN RECOMMENDATION

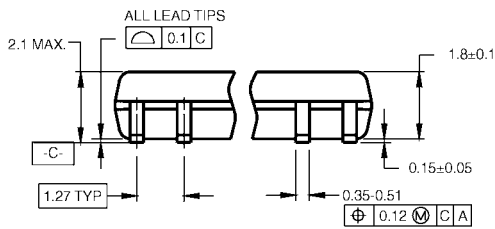

DIMENSIONS ARE IN MILLIMETERS

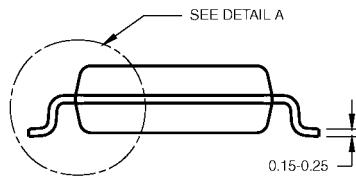

NOTES:

- A. CONFORMS TO EIAJ EDR-7320 REGISTRATION, ESTABLISHED IN DECEMBER, 1998.
- B. DIMENSIONS ARE IN MILLIMETERS.
- C. DIMENSIONS ARE EXCLUSIVE OF BURRS, MOLD FLASH, AND TIE BAR EXTRUSIONS.

M20DRevB1

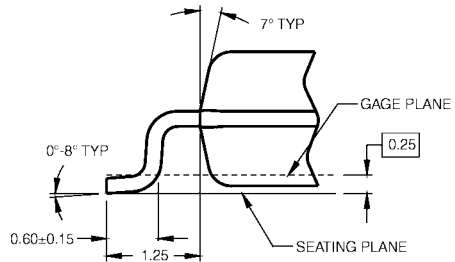

DETAIL A

**Pb-Free 20-Lead Small Outline Package (SOP), EIAJ TYPE II, 5.3mm Wide
Package Number M20D**

Physical Dimensions inches (millimeters) unless otherwise noted (Continued)

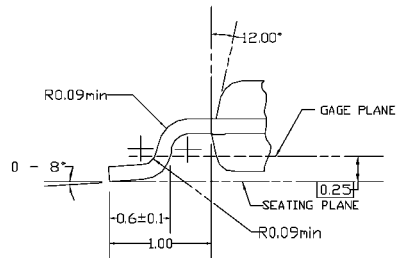
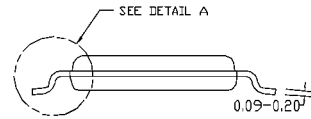
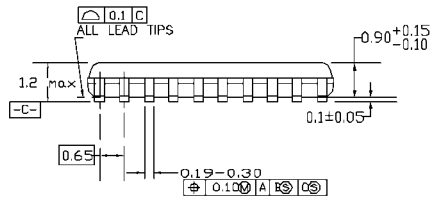
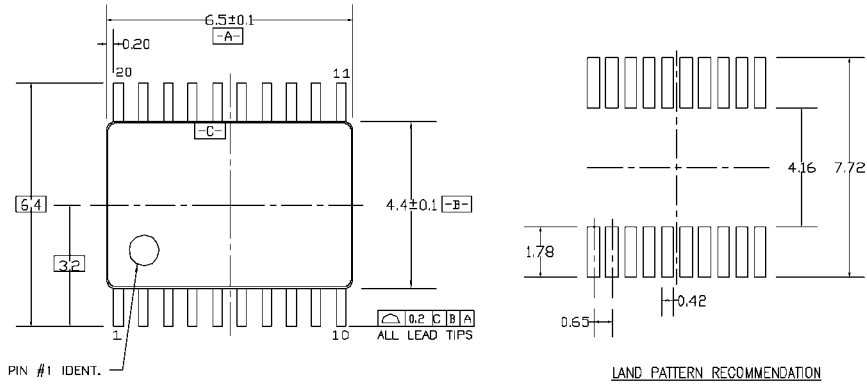

DIMENSIONS ARE IN MILLIMETERS

NOTES:

- A. CONFORMS TO JEDEC REGISTRATION MO-153, VARIATION AC, REF NOTE 6, DATE 7/93.
- B. DIMENSIONS ARE IN MILLIMETERS.
- C. DIMENSIONS ARE EXCLUSIVE OF BURRS, MOLDS FLASH, AND THE BAR EXTRUSIONS.
- D. DIMENSIONS AND TOLERANCES PER ANSI Y14.5M, 1982.

MTC20REV D1

**20-Lead Thin Shrink Small Outline Package (TSSOP), JEDEC MO-153, 4.4mm Wide
Package Number MTC20**

Physical Dimensions inches (millimeters) unless otherwise noted (Continued)

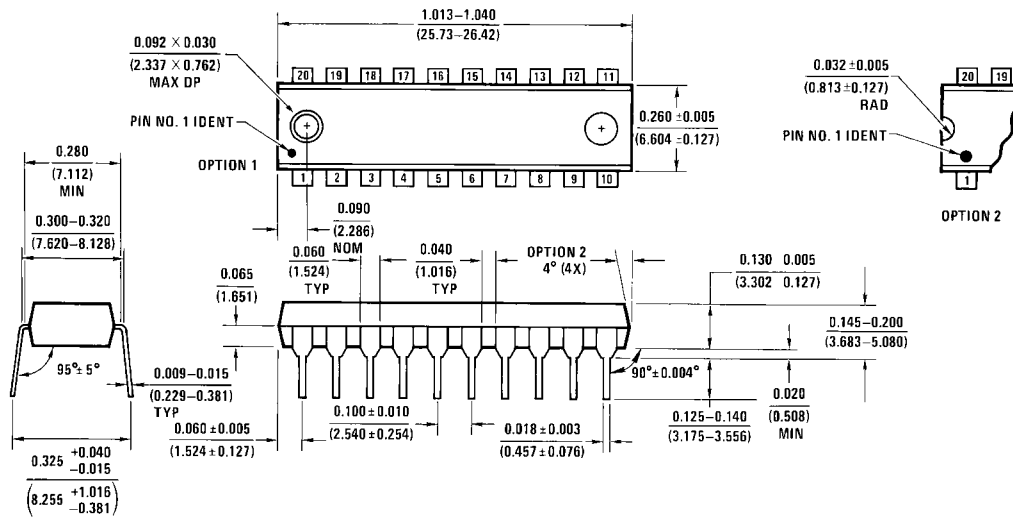

**20-Lead Plastic Dual-In-Line Package (PDIP), JEDEC MS-001, 0.300" Wide
Package Number N20A**

Fairchild does not assume any responsibility for use of any circuitry described, no circuit patent licenses are implied and Fairchild reserves the right at any time without notice to change said circuitry and specifications.

LIFE SUPPORT POLICY

FAIRCHILD'S PRODUCTS ARE NOT AUTHORIZED FOR USE AS CRITICAL COMPONENTS IN LIFE SUPPORT DEVICES OR SYSTEMS WITHOUT THE EXPRESS WRITTEN APPROVAL OF THE PRESIDENT OF FAIRCHILD SEMICONDUCTOR CORPORATION. As used herein:

1. Life support devices or systems are devices or systems which, (a) are intended for surgical implant into the body, or (b) support or sustain life, and (c) whose failure to perform when properly used in accordance with instructions for use provided in the labeling, can be reasonably expected to result in a significant injury to the user.
2. A critical component in any component of a life support device or system whose failure to perform can be reasonably expected to cause the failure of the life support device or system, or to affect its safety or effectiveness.

www.fairchildsemi.com