

Cortex-M3 Reference Manual

EFM32 Microcontroller Family

0 1 2 3 4

- 32-bit ARM Cortex-M3 processor running up to 32 MHz
- Up to 128 KB Flash and 16 KB RAM memory
- Energy efficient and fast autonomous peripherals
- Ultra low power Energy Modes

The EFM32 microcontroller family revolutionizes the 8- to 32-bit market with a combination of unmatched performance and ultra low power consumption in both active- and sleep modes. EFM32 devices only consume 180 μ A per MHz in run mode.

EFM32's low energy consumption by far outperforms any other available 8-, 16-, and 32-bit solution. The EFM32 includes autonomous and very energy efficient peripherals, high overall chip- and analog integration, and the performance of the industry standard 32-bit ARM Cortex-M3 processor.

Innovative and ultra efficient low energy modes with sub μ A operation further enhance EFM32's ultra low power behaviour and makes the EFM32 microcontrollers perfect for long-lasting battery operated applications.

1 Introduction

1.1 About this document

This document provides the information required to use the ARM Cortex-M3 core in EFM32 microcontrollers. Further details on the specific implementations within the EFM32 devices can be found in the reference manual and datasheet for the specific device. This document does not provide information on debug components, features, or operation.

This material is for microcontroller software and hardware engineers, including those who have no experience of ARM products.

1.1.1 Typographical conventions

The typographical conventions used in this document are:

<i>italic</i>	Highlights important notes, introduces special terminology, denotes internal cross-references, and citations.
bold	Denotes signal names. Also used for terms in descriptive lists, where appropriate.
< and >	Enclose replaceable terms for assembler syntax where they appear in code or code fragments. For example:

```
LDRSB<cond> <Rt>, [<Rn>, #<offset>]
```

1.2 About the EFM32 Cortex-M3 processor and core peripherals

The EFM32 Cortex™-M3 processor is a high performance 32-bit processor designed for the microcontroller market. It offers significant benefits to developers, including:

- outstanding processing performance combined with fast interrupt handling
- enhanced system debug with extensive breakpoint and trace capabilities
- efficient processor core, system and memories
- ultra-low power consumption with integrated sleep modes
- platform security, with integrated *memory protection unit* (MPU). Only available in some devices.

Figure 1.1. EFM32 Cortex-M3 implementation

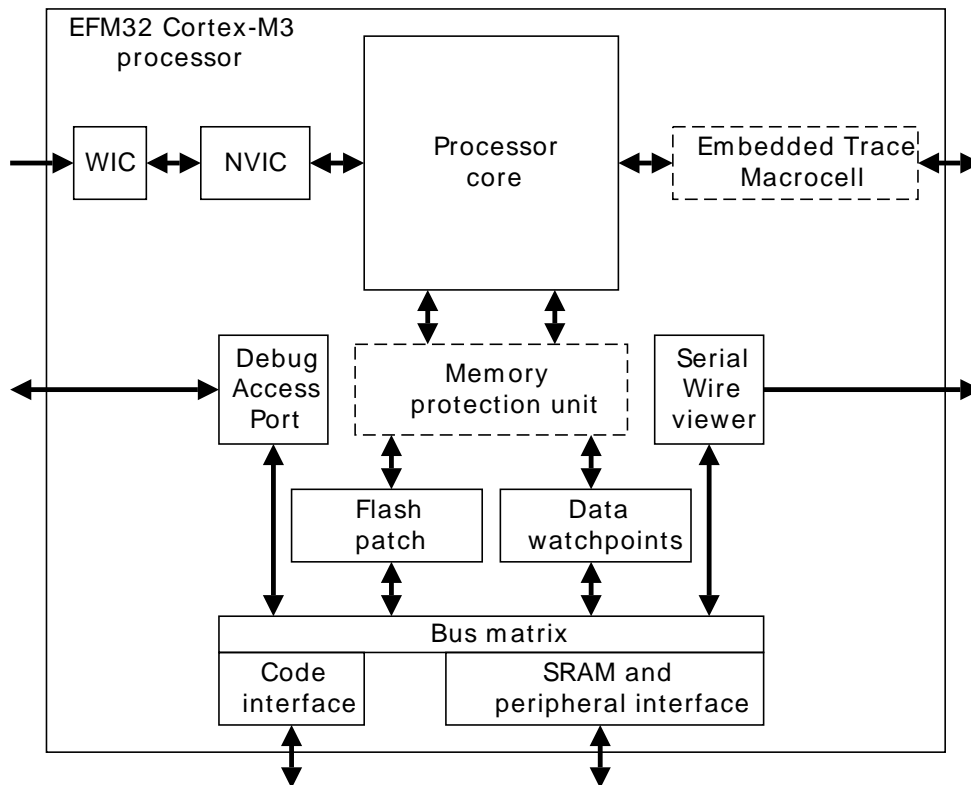

The Cortex-M3 processor is built on a high-performance processor core, with a 3-stage pipeline Harvard architecture, making it ideal for demanding embedded applications. The processor delivers exceptional power efficiency through an efficient instruction set and extensively optimized design, providing high-end processing hardware including single-cycle 32x32 multiplication and dedicated hardware division.

To facilitate the design of cost-sensitive devices, the Cortex-M3 processor implements tightly-coupled system components that reduce processor area while significantly improving interrupt handling and system debug capabilities. The Cortex-M3 processor implements a version of the Thumb® instruction set, ensuring high code density and reduced program memory requirements. The Cortex-M3 instruction set provides the exceptional performance expected of a modern 32-bit architecture, with the high code density of 8-bit and 16-bit microcontrollers.

The Cortex-M3 processor closely integrates a configurable *nested interrupt controller* (NVIC), to deliver industry-leading interrupt performance. The NVIC includes a *non-maskable interrupt* (NMI), and provides up to 8 interrupt priority levels. The tight integration of the processor core and NVIC provides fast execution of *interrupt service routines* (ISRs), dramatically reducing the interrupt latency. This is achieved through the hardware stacking of registers, and the ability to suspend load-multiple and store-multiple operations. Interrupt handlers do not require any assembler stubs, removing any code overhead from the ISRs. Tail-chaining optimization also significantly reduces the overhead when switching from one ISR to another.

To optimize low-power designs, the NVIC integrates with the sleep modes, that include a deep sleep function that enables the entire device to be rapidly powered down.

1.2.1 System level interface

The Cortex-M3 processor provides multiple interfaces using AMBA® technology to provide high speed, low latency memory accesses. It supports unaligned data accesses and implements atomic bit manipulation that enables faster peripheral controls, system spinlocks and thread-safe Boolean data handling.

The Cortex-M3 processor in some EFM32 devices include a *memory protection unit* (MPU) that provides fine grain memory control, enabling applications to implement security privilege levels, separating code, data and stack on a task-by-task basis. Such requirements are becoming critical in many embedded applications such as automotive. The Memory Protection Unit is only available in some EFM32 devices (Table 1.1 (p. 5)).

1.2.2 Integrated configurable debug

The Cortex-M3 processor implements a complete hardware debug solution. This provides high system visibility of the processor and memory through a 2-pin *Serial Wire Debug* (SWD) port that is ideal for microcontrollers and other small package devices.

For system trace the processor integrates an *Instrumentation Trace Macrocell* (ITM) alongside data watchpoints and a profiling unit. To enable simple and cost-effective profiling of the system events these generate, a *Serial Wire Viewer* (SWV) can export a stream of software-generated messages, data trace, and profiling information through a single pin.

The *Embedded Trace Macrocell*[™] (ETM) delivers unrivalled instruction trace capture in an area far smaller than traditional trace units. The ETM is only available in some EFM32 devices (Table 1.1 (p. 5)).

1.2.3 Cortex-M3 processor features and benefits summary

- tight integration of system peripherals reduces area and development costs
- Thumb instruction set combines high code density with 32-bit performance
- code-patch ability for ROM system updates
- power control optimization of system components
- integrated sleep modes for low power consumption
- fast code execution permits slower processor clock or increases sleep mode time
- hardware division and fast multiplier
- deterministic, high-performance interrupt handling for time-critical applications
- *memory protection unit* (MPU) for safety-critical applications. Only available on some devices.
- extensive debug and trace capabilities:
 - Serial Wire Debug and Serial Wire Trace reduce the number of pins required for debugging and tracing.

1.2.4 Cortex-M3 core peripherals

These are:

Nested Vectored Interrupt Controller
System control block

The *Nested Vectored Interrupt Controller* (NVIC) is an embedded interrupt controller that supports low latency interrupt processing.

The *System control block* (SCB) is the programmers model interface to the processor. It provides system implementation information and system control, including configuration, control, and reporting of system exceptions.

System timer

The system timer, SysTick, is a 24-bit count-down timer. Use this as a Real Time Operating System (RTOS) tick timer or as a simple counter.

Memory protection unit

The *Memory protection unit* (MPU) improves system reliability by defining the memory attributes for different memory regions. It provides up to eight different regions, and an optional predefined background region. The Memory Protection Unit is only available in some EFM32 devices (Table 1.1 (p. 5)).

1.2.5 EFM32 Cortex-M3 configurations

The different EFM32 series contain different subsets of peripherals within the ARM Cortex-M3. Table 1.1 (p. 5) shows which features are included in the different EFM32 series.

Table 1.1. Cortex-M3 configuration in EFM32 series

Feature	EFM32G	EFM32TG	EFM32GG
ARM Cortex-M3 version and revision	r2p0	r2p1	r2p1
Number of interrupts	30	23	38
Memory Protection Unit (MPU)	Yes	No	Yes
Embedded Trace Macrocell (ETM)	No	No	Yes

2 The Cortex-M3 Processor

2.1 Programmers model

This section describes the Cortex-M3 programmers model. In addition to the individual core register descriptions, it contains information about the processor modes and privilege levels for software execution and stacks.

2.1.1 Processor mode and privilege levels for software execution

The processor *modes* are:

Thread mode	Used to execute application software. The processor enters Thread mode when it comes out of reset.
Handler mode	Used to handle exceptions. The processor returns to Thread mode when it has finished exception processing.

The *privilege levels* for software execution are:

Unprivileged	<p>The software:</p> <ul style="list-style-type: none"> • has limited access to the MSR and MRS instructions, and cannot use the CPS instruction • cannot access the system timer, NVIC, or system control block • might have restricted access to memory or peripherals. <p><i>Unprivileged software</i> executes at the unprivileged level.</p>
Privileged	<p>The software can use all the instructions and has access to all resources.</p> <p><i>Privileged software</i> executes at the privileged level.</p>

In Thread mode, the CONTROL register controls whether software execution is privileged or unprivileged, see Section 2.1.3.7 (p. 12) . In Handler mode, software execution is always privileged.

Only privileged software can write to the CONTROL register to change the privilege level for software execution in Thread mode. Unprivileged software can use the SVC instruction to make a *supervisor call* to transfer control to privileged software.

2.1.2 Stacks

The processor uses a full descending stack. This means the stack pointer indicates the last stacked item on the stack memory. When the processor pushes a new item onto the stack, it decrements the stack pointer and then writes the item to the new memory location. The processor implements two stacks, the *main stack* and the *process stack*, with independent copies of the stack pointer, see Section 2.1.3.2 (p. 8) .

In Thread mode, the CONTROL register controls whether the processor uses the main stack or the process stack, see Section 2.1.3.7 (p. 12) . In Handler mode, the processor always uses the main stack. The options for processor operations are:

Table 2.1. Summary of processor mode, execution privilege level, and stack use options

Processor mode	Used to execute	Privilege level for software execution	Stack used
Thread	Applications	Privileged or unprivileged ¹	Main stack or process stack ¹

Processor mode	Used to execute	Privilege level for software execution	Stack used
Handler	Exception handlers	Always privileged	Main stack

[†]See Section 2.1.3.7 (p. 12) .

2.1.3 Core registers

The processor core registers are:

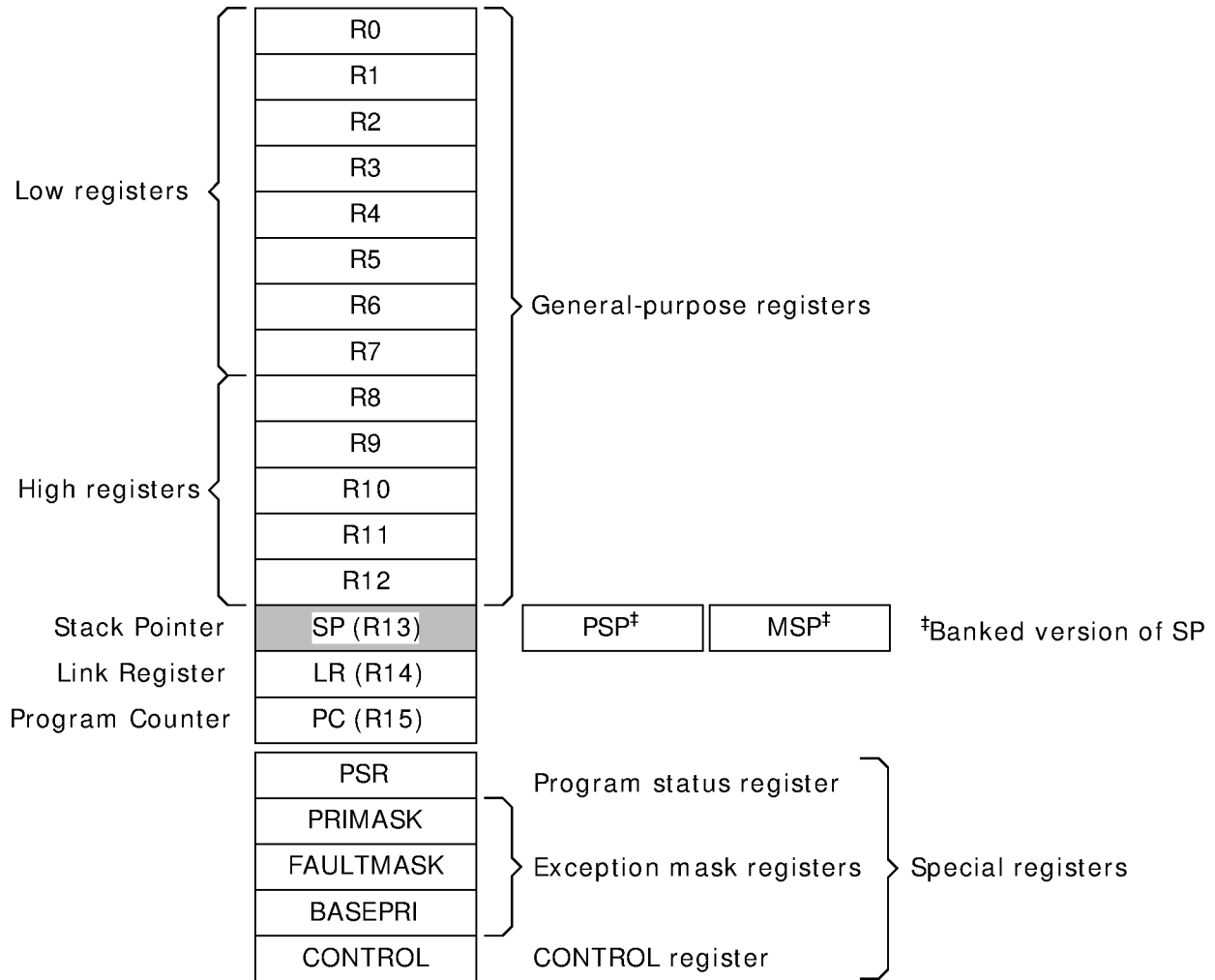

Table 2.2. Core register set summary

Name	Type ¹	Required privilege ²	Reset value	Description
R0-R12	RW	Either	Unknown	Section 2.1.3.1 (p. 8)
MSP	RW	Privileged	See description	Section 2.1.3.2 (p. 8)
PSP	RW	Either	Unknown	Section 2.1.3.2 (p. 8)
LR	RW	Either	0xFFFFFFFF	Section 2.1.3.3 (p. 8)
PC	RW	Either	See description	Section 2.1.3.4 (p. 8)
PSR	RW	Privileged	0x01000000	Section 2.1.3.5 (p. 8)
ASPR	RW	Either	0x00000000	Section 2.1.3.5.1 (p. 9)
IPSR	RO	Privileged	0x00000000	Section 2.1.3.5.2 (p. 10)
EPSR	RO	Privileged	0x01000000	Section 2.1.3.5.3 (p. 10)

Name	Type ¹	Required privilege ²	Reset value	Description
PRIMASK	RW	Privileged	0x00000000	Section 2.1.3.6.1 (p. 11)
FAULTMASK	RW	Privileged	0x00000000	Section 2.1.3.6.2 (p. 11)
BASEPRI	RW	Privileged	0x00000000	Section 2.1.3.6.3 (p. 12)
CONTROL	RW	Privileged	0x00000000	Section 2.1.3.7 (p. 12)

¹ Describes access type during program execution in thread mode and Handler mode. Debug access can differ.

² An entry of Either means privileged and unprivileged software can access the register.

2.1.3.1 General-purpose registers

R0-R12 are 32-bit general-purpose registers for data operations.

2.1.3.2 Stack Pointer

The *Stack Pointer* (SP) is register R13. In Thread mode, bit[1] of the CONTROL register indicates the stack pointer to use:

- 0 = *Main Stack Pointer* (MSP). This is the reset value.
- 1 = *Process Stack Pointer* (PSP).

On reset, the processor loads the MSP with the value from address 0x00000000.

2.1.3.3 Link Register

The *Link Register* (LR) is register R14. It stores the return information for subroutines, function calls, and exceptions. On reset, the processor loads the LR value 0xFFFFFFFF.

2.1.3.4 Program Counter

The *Program Counter* (PC) is register R15. It contains the current program address. Bit[0] is always 0 because instruction fetches must be halfword aligned. On reset, the processor loads the PC with the value of the reset vector, which is at address 0x00000004.

2.1.3.5 Program Status Register

The *Program Status Register* (PSR) combines:

- *Application Program Status Register* (APSR)
- *Interrupt Program Status Register* (IPSR)
- *Execution Program Status Register* (EPSR).

These registers are mutually exclusive bitfields in the 32-bit PSR. The bit assignments are:

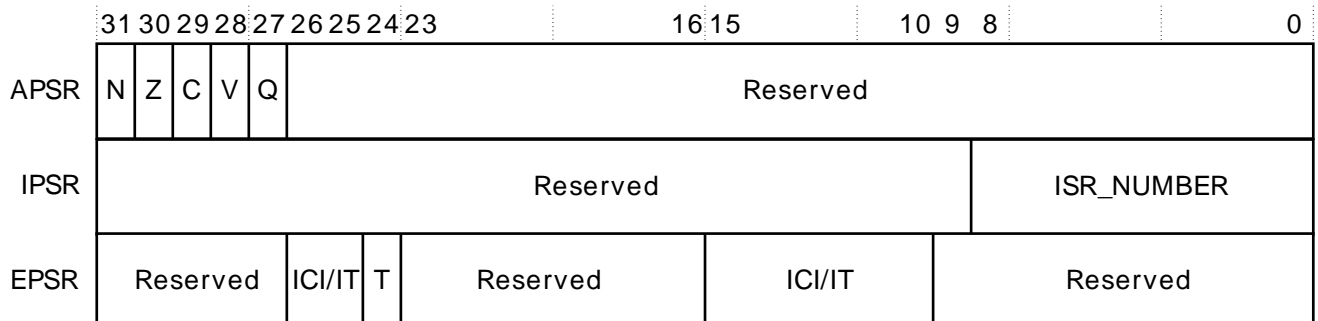

The PSR bit assignments are:

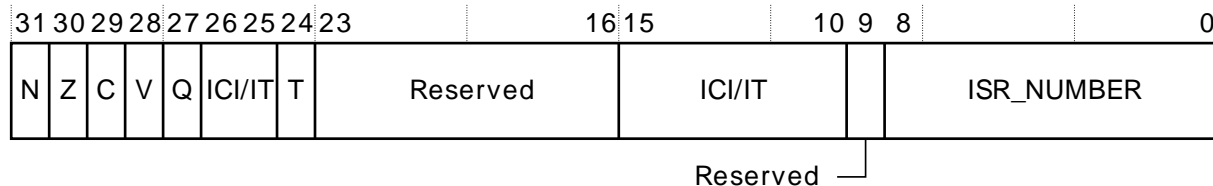

Access these registers individually or as a combination of any two or all three registers, using the register name as an argument to the MSR or MRS instructions. For example:

- read all of the registers using `PSR` with the `MRS` instruction
- write to the APSR using `APSR` with the `MSR` instruction.

The PSR combinations and attributes are:

Table 2.3. PSR register combinations

Register	Type	Combination
PSR	RW ^{1,2}	APSR, EPSR, and IPSR
IEPSR	RO	EPSR and IPSR
IAPSR	RW ¹	APSR and IPSR
EAPSR	RW ²	APSR and EPSR

¹The processor ignores writes to the IPSR bits.

²Reads of the EPSR bits return zero, and the processor ignores writes to the these bits

See the instruction descriptions Section 3.10.6 (p. 83) and Section 3.10.7 (p. 83) for more information about how to access the program status registers.

2.1.3.5.1 Application Program Status Register

The APSR contains the current state of the condition flags from previous instruction executions. See the register summary in Table 2.2 (p. 7) for its attributes. The bit assignments are:

Table 2.4. APSR bit assignments

Bits	Name	Function
[31]	N	Negative or less than flag: 0 = operation result was positive, zero, greater than, or equal 1 = operation result was negative or less than.
[30]	Z	Zero flag: 0 = operation result was not zero 1 = operation result was zero.
[29]	C	Carry or borrow flag: 0 = add operation did not result in a carry bit or subtract operation resulted in a borrow bit 1 = add operation resulted in a carry bit or subtract operation did not result in a borrow bit.
[28]	V	Overflow flag: 0 = operation did not result in an overflow 1 = operation resulted in an overflow.
[27]	Q	Sticky saturation flag: 0 = indicates that saturation has not occurred since reset or since the bit was last cleared to zero 1 = indicates when an <code>SSAT</code> or <code>USAT</code> instruction results in saturation. This bit is cleared to zero by software using an <code>MRS</code> instruction.
[26:0]	-	Reserved.

2.1.3.5.2 Interrupt Program Status Register

The IPSR contains the exception type number of the current *Interrupt Service Routine* (ISR). See the register summary in Table 2.2 (p. 7) for its attributes. The bit assignments are:

Table 2.5. IPSR bit assignments

Bits	Name	Function
[31:9]	-	Reserved
[8:0]	ISR_NUMBER	This is the number of the current exception: 0 = Thread mode 1 = Reserved 2 = NMI 3 = Hard fault 4 = Memory management fault 5 = Bus fault 6 = Usage fault 7-10 = Reserved 11 = SVCall 12 = Reserved for Debug 13 = Reserved 14 = PendSV 15 = SysTick 16 = IRQ0. . . N = IRQ(N-16). See Table 1.1 (p. 5) for device specific interrupt number. see Section 2.3.2 (p. 22) for more information.

2.1.3.5.3 Execution Program Status Register

The EPSR contains the Thumb state bit, and the execution state bits for either the:

- *If-Then* (IT) instruction
- *Interruptible-Continuable Instruction* (ICI) field for an interrupted load multiple or store multiple instruction.

See the register summary in Table 2.2 (p. 7) for the EPSR attributes. The bit assignments are:

Table 2.6. EPSR bit assignments

Bits	Name	Function
[31:27]	-	Reserved.
[26:25], [15:10]	ICI	Interruptible-continuable instruction bits, see Section 2.1.3.5.4 (p. 11) .
[26:25], [15:10]	IT	Indicates the execution state bits of the IT instruction, see Section 3.9.3 (p. 76) .
[24]	T	Always set to 1.
[23:16]	-	Reserved.
[9:0]	-	Reserved.

Attempts to read the EPSR directly through application software using the MSR instruction always return zero. Attempts to write the EPSR using the MSR instruction in application software are ignored. Fault

handlers can examine EPSR value in the stacked PSR to indicate the operation that is at fault. See Section 2.3.7 (p. 26)

2.1.3.5.4 Interruptible-continuable instructions

When an interrupt occurs during the execution of an LDM or STM instruction, the processor:

- stops the load multiple or store multiple instruction operation temporarily
- stores the next register operand in the multiple operation to EPSR bits[15:12].

After servicing the interrupt, the processor:

- returns to the register pointed to by bits[15:12]
- resumes execution of the multiple load or store instruction.

When the EPSR holds ICI execution state, bits[26:25,11:10] are zero.

2.1.3.5.5 If-Then block

The If-Then block contains up to four instructions following a 16-bit IT instruction. Each instruction in the block is conditional. The conditions for the instructions are either all the same, or some can be the inverse of others. See Section 3.9.3 (p. 76) for more information.

2.1.3.6 Exception mask registers

The exception mask registers disable the handling of exceptions by the processor. Disable exceptions where they might impact on timing critical tasks.

To access the exception mask registers use the MSR and MRS instructions, or the CPS instruction to change the value of PRIMASK or FAULTMASK. See Section 3.10.6 (p. 83), Section 3.10.7 (p. 83), and Section 3.10.2 (p. 80) for more information.

2.1.3.6.1 Priority Mask Register

The PRIMASK register prevents activation of all exceptions with configurable priority. See the register summary in Table 2.2 (p. 7) for its attributes. The bit assignments are:

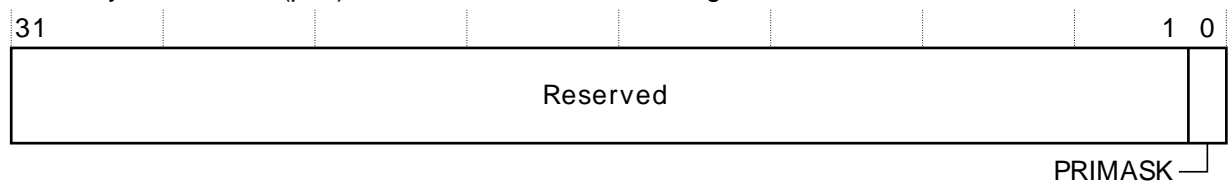

Table 2.7. PRIMASK register bit assignments

Bits	Name	Function
[31:1]	-	Reserved
[0]	PRIMASK	0 = no effect 1 = prevents the activation of all exceptions with configurable priority.

2.1.3.6.2 Fault Mask Register

The FAULTMASK register prevents activation of all exceptions except for *Non-Maskable Interrupt* (NMI). See the register summary in Table 2.2 (p. 7) for its attributes. The bit assignments are:

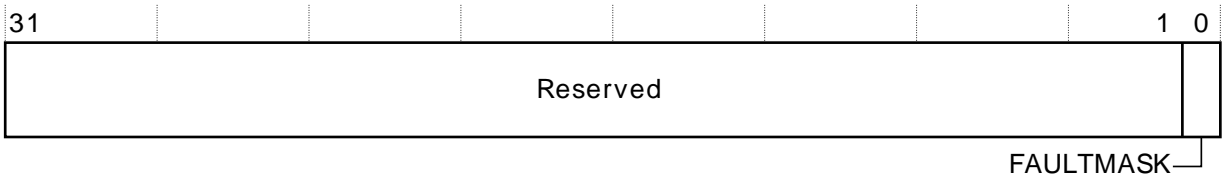

Table 2.8. FAULTMASK register bit assignments

Bits	Name	Function
[31:1]	-	Reserved
[0]	FAULTMASK	0 = no effect 1 = prevents the activation of all exceptions except for NMI.

The processor clears the FAULTMASK bit to 0 on exit from any exception handler except the NMI handler.

2.1.3.6.3 Base Priority Mask Register

The BASEPRI register defines the minimum priority for exception processing. When BASEPRI is set to a nonzero value, it prevents the activation of all exceptions with same or lower priority level as the BASEPRI value. See the register summary in Table 2.2 (p. 7) for its attributes. The bit assignments are:



Table 2.9. BASEPRI register bit assignments

Bits	Name	Function
[31:8]	-	Reserved
[7:0]	BASEPRI ¹	Priority mask bits: 0x0000 = no effect Nonzero = defines the base priority for exception processing. The processor does not process any exception with a priority value greater than or equal to BASEPRI.

¹This field is similar to the priority fields in the interrupt priority registers. The processor implements only bits[7:5 of this field, bits[4:0] read as zero and ignore writes. See Section 4.2.7 (p. 92) for more information. Remember that higher priority field values correspond to lower exception priorities.

2.1.3.7 CONTROL register

The CONTROL register controls the stack used and the privilege level for software execution when the processor is in Thread mode. See the register summary in Table 2.2 (p. 7) for its attributes. The bit assignments are:

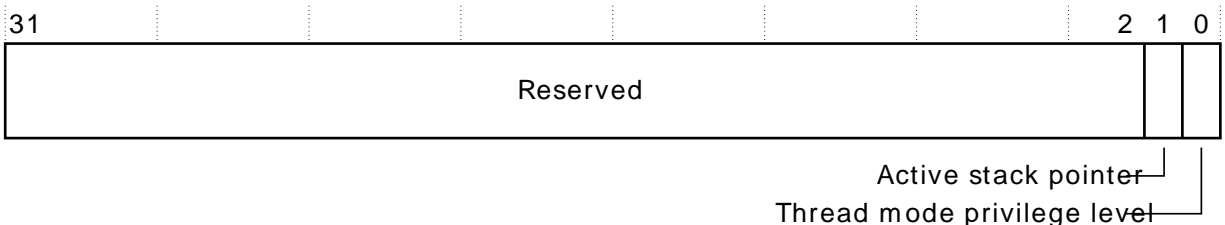

Table 2.10. CONTROL register bit assignments

Bits	Name	Function
[31:2]	-	Reserved
[1]	Active stack pointer	Defines the current stack: 0 = MSP is the current stack pointer 1 = PSP is the current stack pointer. In Handler mode this bit reads as zero and ignores writes.
[0]	Thread mode privilege level	Defines the Thread mode privilege level: 0 = privileged1 = unprivileged.

Handler mode always uses the MSP, so the processor ignores explicit writes to the active stack pointer bit of the CONTROL register when in Handler mode. The exception entry and return mechanisms update the CONTROL register.

In an OS environment, it is recommended that threads running in Thread mode use the process stack and the kernel and exception handlers use the main stack.

By default, Thread mode uses the MSP. To switch the stack pointer used in Thread mode to the PSP, use the MSR instruction to set the Active stack pointer bit to 1, see Section 3.10.7 (p. 83) .

Note

When changing the stack pointer, software must use an ISB instruction immediately after the MSR instruction. This ensures that instructions after the ISB execute using the new stack pointer. See Section 3.10.5 (p. 82)

2.1.4 Exceptions and interrupts

The Cortex-M3 processor supports interrupts and system exceptions. The processor and the *Nested Vectored Interrupt Controller* (NVIC) prioritize and handle all exceptions. An exception changes the normal flow of software control. The processor uses handler mode to handle all exceptions except for reset. See Section 2.3.7.1 (p. 27) and Section 2.3.7.2 (p. 27) for more information.

The NVIC registers control interrupt handling. See Section 4.2 (p. 88) for more information.

2.1.5 Data types

The processor:

- supports the following data types:
 - 32-bit words
 - 16-bit halfwords
 - 8-bit bytes
- supports 64-bit data transfer instructions.
- manages all data memory accesses as little-endian. See Section 2.2.1 (p. 15) for more information.

2.1.6 The Cortex Microcontroller Software Interface Standard

For a Cortex-M3 microcontroller system, the *Cortex Microcontroller Software Interface Standard* (CMSIS) defines:

- a common way to:

- access peripheral registers
- define exception vectors
- the names of:
 - the registers of the core peripherals
 - the core exception vectors
- a device-independent interface for RTOS kernels, including a debug channel.

The CMSIS includes address definitions and data structures for the core peripherals in the Cortex-M3 processor. It also includes optional interfaces for middleware components comprising a TCP/IP stack and a Flash file system.

CMSIS simplifies software development by enabling the reuse of template code and the combination of CMSIS-compliant software components from various middleware vendors. Software vendors can expand the CMSIS to include their peripheral definitions and access functions for those peripherals.

This document includes the register names defined by the CMSIS, and gives short descriptions of the CMSIS functions that address the processor core and the core peripherals.

Note

This document uses the register short names defined by the CMSIS. In a few cases these differ from the architectural short names that might be used in other documents.

The following sections give more information about the CMSIS:

- Section 2.5.4 (p. 32)
- Section 3.2 (p. 37)
- Section 4.2.1 (p. 89)
- Section 4.2.10.1 (p. 94) .

2.2 Memory model

This section describes the processor memory map, the behavior of memory accesses, and the bit-banding features. The processor has a fixed memory map that provides up to 4GB of addressable memory. The memory map is:

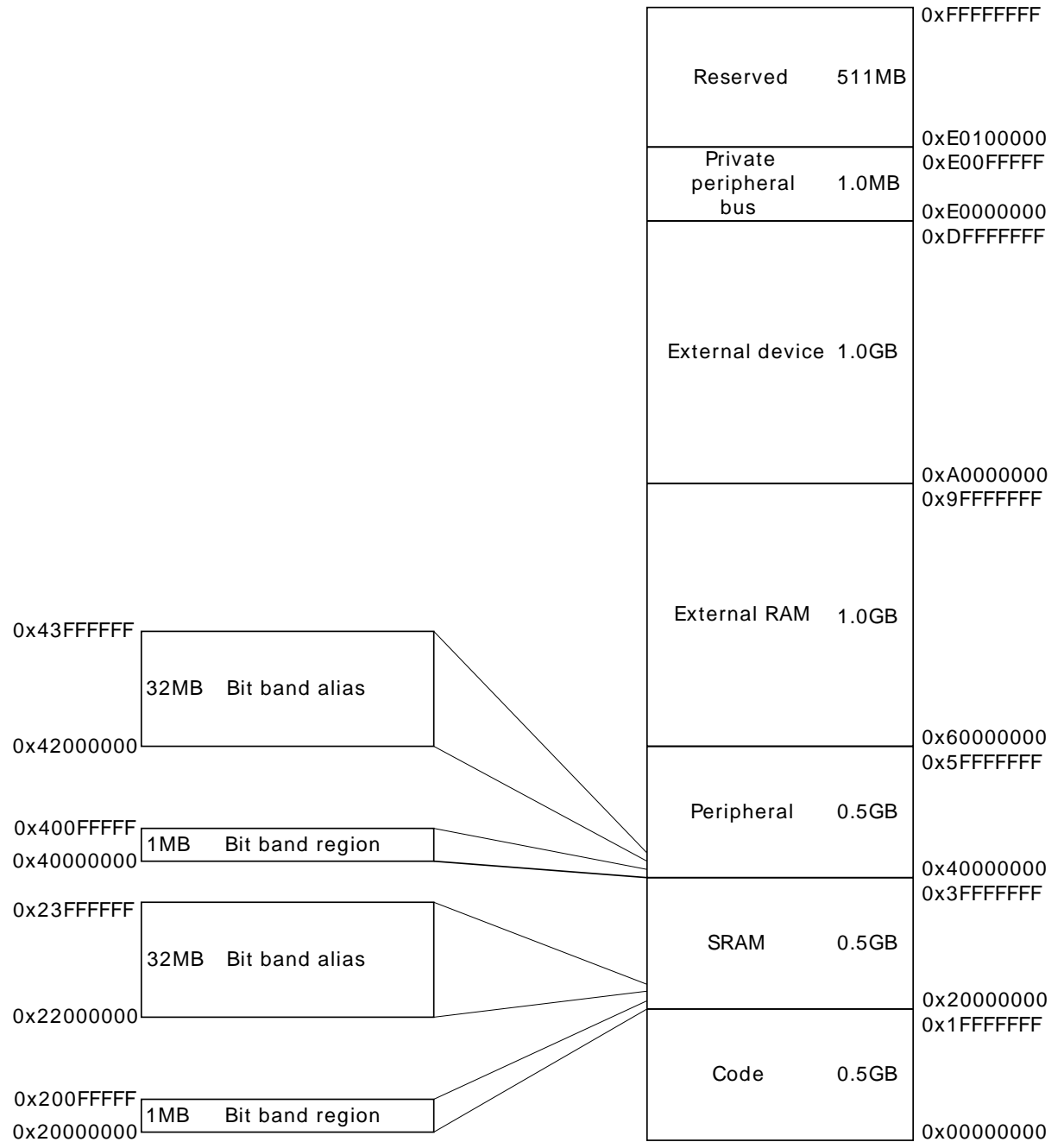

The regions for SRAM and peripherals include bit-band regions. Bit-banding provides atomic operations to bit data, see Section 2.2.5 (p. 18) .

The processor reserves regions of the *Private peripheral bus* (PPB) address range for core peripheral registers, see Section 4.1 (p. 88) .

2.2.1 Memory regions, types and attributes

The memory map and the programming of the MPU split the memory map into regions. Each region has a defined memory type, and some regions have additional memory attributes. The memory type and attributes determine the behavior of accesses to the region.

The memory types are:

- Normal The processor can re-order transactions for efficiency, or perform speculative reads.

Device	The processor preserves transaction order relative to other transactions to Device or Strongly-ordered memory.
Strongly-ordered	The processor preserves transaction order relative to all other transactions.

The different ordering requirements for Device and Strongly-ordered memory mean that the memory system can buffer a write to Device memory, but must not buffer a write to Strongly-ordered memory.

The additional memory attributes include.

Execute Never (XN) Means the processor prevents instruction accesses. Any attempt to fetch an instruction from an XN region causes a memory management fault exception.

2.2.2 Memory system ordering of memory accesses

For most memory accesses caused by explicit memory access instructions, the memory system does not guarantee that the order in which the accesses complete matches the program order of the instructions, providing this does not affect the behavior of the instruction sequence. Normally, if correct program execution depends on two memory accesses completing in program order, software must insert a memory barrier instruction between the memory access instructions, see Section 2.2.4 (p. 17) .

However, the memory system does guarantee some ordering of accesses to Device and Strongly-ordered memory. For two memory access instructions A1 and A2, if A1 occurs before A2 in program order, the ordering of the memory accesses caused by two instructions is:

A1 \ A2	Normal access	Device access		Strongly-ordered access
		Non-shareable	Shareable	
Normal access	-	-	-	-
Device access, non-shareable	-	<	-	<
Device access, shareable	-	-	<	<
Strongly-ordered access	-	<	<	<

Where:

- Means that the memory system does not guarantee the ordering of the accesses.
- < Means that accesses are observed in program order, that is, A1 is always observed before A2.

2.2.3 Behavior of memory accesses

The behavior of accesses to each region in the memory map is:

Table 2.11. Memory access behavior

Address range	Memory region	Memory type	XN	Description
0x00000000- 0x1FFFFFFF	Code	Normal ¹	-	Executable region for program code. You can also put data here.
0x20000000- 0x3FFFFFFF	SRAM	Normal ¹	-	Executable region for data. You can also put code here. This region includes bit band and bit band alias areas, see Table 2.12 (p. 18)
0x40000000- 0x5FFFFFFF	Peripheral	Device ¹	XN ¹	This region includes bit band and bit band alias areas, see Table 2.13 (p. 18) .

Address range	Memory region	Memory type	XN	Description
0x60000000-0x9FFFFFFF	External RAM	Normal ¹	-	Executable region for data.
0xA0000000-0xDFFFFFFF	External device	Device ¹	XN ¹	External Device memory
0xE0000000-0xE00FFFFFFF	Private Peripheral Bus	Strongly-ordered ¹	XN ¹	This region includes the NVIC, System timer, and system control block.
0xE0100000-0xFFFFFFFF	Reserved	Device ¹	XN ¹	Reserved

¹See Section 2.2.1 (p. 15) for more information.

The Code, SRAM, and external RAM regions can hold programs. However, ARM recommends that programs always use the Code region. This is because the processor has separate buses that enable instruction fetches and data accesses to occur simultaneously.

The MPU can override the default memory access behavior described in this section. For more information, see Section 4.5 (p. 113).

2.2.4 Software ordering of memory accesses

The order of instructions in the program flow does not always guarantee the order of the corresponding memory transactions. This is because:

- the processor can reorder some memory accesses to improve efficiency, providing this does not affect the behavior of the instruction sequence.
- the processor has multiple bus interfaces
- memory or devices in the memory map have different wait states
- some memory accesses are buffered or speculative.

Section 2.2.2 (p. 16) describes the cases where the memory system guarantees the order of memory accesses. Otherwise, if the order of memory accesses is critical, software must include memory barrier instructions to force that ordering. The processor provides the following memory barrier instructions:

DMB	The <i>Data Memory Barrier</i> (DMB) instruction ensures that outstanding memory transactions complete before subsequent memory transactions. See Section 3.10.3 (p. 81).
DSB	The <i>Data Synchronization Barrier</i> (DSB) instruction ensures that outstanding memory transactions complete before subsequent instructions execute. See Section 3.10.4 (p. 82).
ISB	The <i>Instruction Synchronization Barrier</i> (ISB) ensures that the effect of all completed memory transactions is recognizable by subsequent instructions. See Section 3.10.5 (p. 82).

Use memory barrier instructions in, for example:

- MPU programming:
 - Use a DSB instruction to ensure the effect of the MPU takes place immediately at the end of context switching.
 - Use an ISB instruction to ensure the new MPU setting takes effect immediately after programming the MPU region or regions, if the MPU configuration code was accessed using a branch or call. If the MPU configuration code is entered using exception mechanisms, then an ISB instruction is not required.
- Vector table. If the program changes an entry in the vector table, and then enables the corresponding exception, use a DMB instruction between the operations. This ensures that if the exception is taken immediately after being enabled the processor uses the new exception vector.

- Self-modifying code. If a program contains self-modifying code, use an `ISB` instruction immediately after the code modification in the program. This ensures subsequent instruction execution uses the updated program.
- Memory map switching. If the system contains a memory map switching mechanism, use a `DSB` instruction after switching the memory map in the program. This ensures subsequent instruction execution uses the updated memory map.
- Dynamic exception priority change. When an exception priority has to change when the exception is pending or active, use `DSB` instructions after the change. This ensures the change takes effect on completion of the `DSB` instruction.
- Using a semaphore in multi-master system. If the system contains more than one bus master, for example, if another processor is present in the system, each processor must use a `DMB` instruction after any semaphore instructions, to ensure other bus masters see the memory transactions in the order in which they were executed.

Memory accesses to Strongly-ordered memory, such as the system control block, do not require the use of `DMB` instructions.

2.2.5 Bit-banding

A bit-band region maps each word in a *bit-band alias* region to a single bit in the *bit-band region*. The bit-band regions occupy the lowest 1MB of the SRAM and peripheral memory regions.

The memory map has two 32MB alias regions that map to two 1MB bit-band regions:

- accesses to the 32MB SRAM alias region map to the 1MB SRAM bit-band region, as shown in Table 2.12 (p. 18)
- accesses to the 32MB peripheral alias region map to the 1MB peripheral bit-band region, as shown in Table 2.13 (p. 18) .

Table 2.12. SRAM memory bit-banding regions

Address range	Memory region	Instruction and data accesses
0x20000000- 0x200FFFFFF	SRAM bit-band region	Direct accesses to this memory range behave as SRAM memory accesses, but this region is also bit addressable through bit-band alias.
0x22000000- 0x23FFFFFF	SRAM bit-band alias	Data accesses to this region are remapped to bit band region. A write operation is performed as read-modify-write. Instruction accesses are not remapped.

Table 2.13. Peripheral memory bit-banding regions

Address range	Memory region	Instruction and data accesses
0x40000000- 0x400FFFFFF	Peripheral bit-band region	Direct accesses to this memory range behave as peripheral memory accesses, but this region is also bit addressable through bit-band alias.
0x42000000- 0x43FFFFFF	Peripheral bit-band alias	Data accesses to this region are remapped to bit band region. A write operation is performed as read-modify-write. Instruction accesses are not permitted.

Note

A word access to the SRAM or peripheral bit-band alias regions map to a single bit in the SRAM or peripheral bit-band region.

The following formula shows how the alias region maps onto the bit-band region:

`bit_word_offset = (byte_offset x 32) + (bit_number x 4)`

`bit_word_addr = bit_band_base + bit_word_offset`

where:

- `Bit_word_offset` is the position of the target bit in the bit-band memory region.
- `Bit_word_addr` is the address of the word in the alias memory region that maps to the targeted bit.
- `Bit_band_base` is the starting address of the alias region.
- `Byte_offset` is the number of the byte in the bit-band region that contains the targeted bit.
- `Bit_number` is the bit position, 0-7, of the targeted bit.

Figure 2.1 (p. 19) shows examples of bit-band mapping between the SRAM bit-band alias region and the SRAM bit-band region:

- The alias word at `0x23FFFFFFE0` maps to bit[0] of the bit-band byte at `0x200FFFFFF`: $0x23FFFFFFE0 = 0x22000000 + (0xFFFFF*32) + (0*4)$.
- The alias word at `0x23FFFFFFFC` maps to bit[7] of the bit-band byte at `0x200FFFFFF`: $0x23FFFFFFFC = 0x22000000 + (0xFFFFF*32) + (7*4)$.
- The alias word at `0x22000000` maps to bit[0] of the bit-band byte at `0x20000000`: $0x22000000 = 0x22000000 + (0*32) + (0*4)$.
- The alias word at `0x2200001C` maps to bit[7] of the bit-band byte at `0x20000000`: $0x2200001C = 0x22000000 + (0*32) + (7*4)$.

Figure 2.1. Bit-band mapping

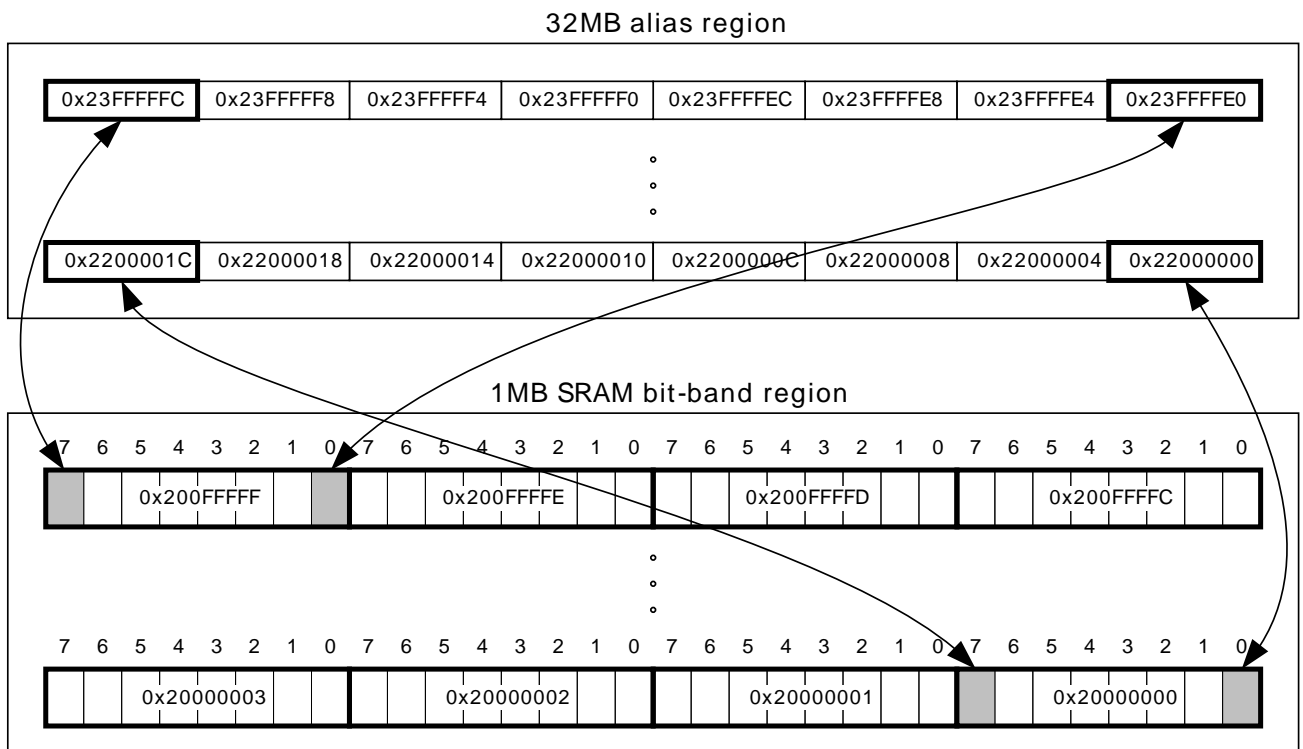

2.2.5.1 Directly accessing an alias region

Writing to a word in the alias region updates a single bit in the bit-band region.

Bit[0] of the value written to a word in the alias region determines the value written to the targeted bit in the bit-band region. Writing a value with bit[0] set to 1 writes a 1 to the bit-band bit, and writing a value with bit[0] set to 0 writes a 0 to the bit-band bit.

Bits[31:1] of the alias word have no effect on the bit-band bit. Writing 0x01 has the same effect as writing 0xFF. Writing 0x00 has the same effect as writing 0x0E.

Reading a word in the alias region:

- 0x00000000 indicates that the targeted bit in the bit-band region is set to zero
- 0x00000001 indicates that the targeted bit in the bit-band region is set to 1

2.2.5.2 Directly accessing a bit-band region

Section 2.2.3 (p. 16) describes the behavior of direct byte, halfword, or word accesses to the bit-band regions.

2.2.6 Memory endianness

The processor views memory as a linear collection of bytes numbered in ascending order from zero. For example, bytes 0-3 hold the first stored word, and bytes 4-7 hold the second stored word. Section 2.2.6.1 (p. 20) describes how words of data are stored in memory.

2.2.6.1 Little-endian format

The EFM32 uses a little-endian format, in which the processor stores the least significant byte of a word at the lowest-numbered byte, and the most significant byte at the highest-numbered byte. For example:

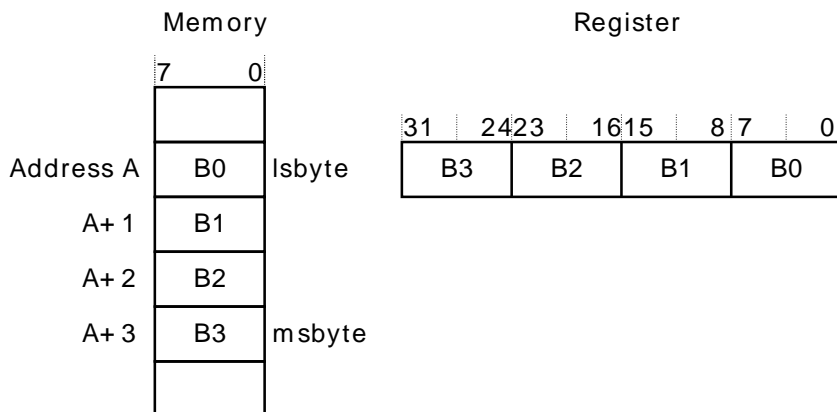

2.2.7 Synchronization primitives

The Cortex-M3 instruction set includes pairs of *synchronization primitives*. These provide a non-blocking mechanism that a thread or process can use to obtain exclusive access to a memory location. Software can use them to perform a guaranteed read-modify-write memory update sequence, or for a semaphore mechanism.

A pair of synchronization primitives comprises:

- A Load-Exclusive instruction Used to read the value of a memory location, requesting exclusive access to that location.
- A Store-Exclusive instruction Used to attempt to write to the same memory location, returning a status bit to a register. If this bit is:
 - 0 it indicates that the thread or process gained exclusive access to the memory, and the write succeeds,
 - 1 it indicates that the thread or process did not gain exclusive access to the memory, and no write is performed,

The pairs of Load-Exclusive and Store-Exclusive instructions are:

- the word instructions LDREX and STREX
- the halfword instructions LDREXH and STREXH
- the byte instructions LDREXB and STREXB.

Software must use a Load-Exclusive instruction with the corresponding Store-Exclusive instruction.

To perform a guaranteed read-modify-write of a memory location, software must:

1. Use a Load-Exclusive instruction to read the value of the location.
2. Update the value, as required.
3. Use a Store-Exclusive instruction to attempt to write the new value back to the memory location, and tests the returned status bit. If this bit is:
 - 0 The read-modify-write completed successfully,
 - 1 No write was performed. This indicates that the value returned at step 1 (p. 21) might be out of date. The software must retry the read-modify-write sequence,

Software can use the synchronization primitives to implement a semaphores as follows:

1. Use a Load-Exclusive instruction to read from the semaphore address to check whether the semaphore is free.
2. If the semaphore is free, use a Store-Exclusive to write the claim value to the semaphore address.
3. If the returned status bit from step 2 (p. 21) indicates that the Store-Exclusive succeeded then the software has claimed the semaphore. However, if the Store-Exclusive failed, another process might have claimed the semaphore after the software performed step 1 (p. 21) .

The Cortex-M3 includes an exclusive access monitor, that tags the fact that the processor has executed a Load-Exclusive instruction.

The processor removes its exclusive access tag if:

- It executes a CLREX instruction
- It executes a Store-Exclusive instruction, regardless of whether the write succeeds.
- An exception occurs. This means the processor can resolve semaphore conflicts between different threads.

For more information about the synchronization primitive instructions, see Section 3.4.8 (p. 54) and Section 3.4.9 (p. 56) .

2.2.8 Programming hints for the synchronization primitives

ANSI C cannot directly generate the exclusive access instructions. Some C compilers provide intrinsic functions for generation of these instructions:

Table 2.14. C compiler intrinsic functions for exclusive access instructions

Instruction	Intrinsic function
LDREX, LDREXH, or LDREXB	unsigned int __ldrex(volatile void *ptr)
STREX, STREXH, or STREXB	int __strex(unsigned int val, volatile void *ptr)
CLREX	void __clrex(void)

The actual exclusive access instruction generated depends on the data type of the pointer passed to the intrinsic function. For example, the following C code generates the require LDREXB operation:

```
__ldrex((volatile char *) 0xFF);
```

2.3 Exception model

This section describes the exception model.

2.3.1 Exception states

Each exception is in one of the following states:

Inactive	The exception is not active and not pending.
Pending	The exception is waiting to be serviced by the processor.
Active	An interrupt request from a peripheral or from software can change the state of the corresponding interrupt to pending. An exception that is being serviced by the processor but has not completed.

Note

An exception handler can interrupt the execution of another exception handler. In this case both exceptions are in the active state.

Active and pending	The exception is being serviced by the processor and there is a pending exception from the same source.
--------------------	---

2.3.2 Exception types

The exception types are:

Reset	Reset is invoked on power up or a warm reset. The exception model treats reset as a special form of exception. When reset is asserted, the operation of the processor stops, potentially at any point in an instruction. When reset is deasserted, execution restarts from the address provided by the reset entry in the vector table. Execution restarts as privileged execution in Thread mode.
NMI	In the EFM32 devices a <i>NonMaskable Interrupt</i> (NMI) can only be triggered by software. This is the highest priority exception other than reset. It is permanently enabled and has a fixed priority of -2. NMIs cannot be: <ul style="list-style-type: none"> masked or prevented from activation by any other exception preempted by any exception other than Reset.
Hard fault	A hard fault is an exception that occurs because of an error during exception processing, or because an exception cannot be managed by any other exception mechanism. Hard faults have a fixed priority of -1, meaning they have higher priority than any exception with configurable priority.
Memory management fault	A memory management fault is an exception that occurs because of a memory protection related fault. The MPU or the fixed memory protection constraints determines this fault, for both instruction and data memory transactions. This fault is used to abort instruction accesses to <i>Execute Never</i> (XN) memory regions, even if the MPU is disabled.
Bus fault	A bus fault is an exception that occurs because of a memory related fault for an instruction or data memory transaction. This might be from an error detected on a bus in the memory system.

Usage fault	<p>A usage fault is an exception that occurs because of a fault related to instruction execution. This includes:</p> <ul style="list-style-type: none"> • an undefined instruction • an illegal unaligned access • invalid state on instruction execution • an error on exception return. <p>The following can cause a usage fault when the core is configured to report them:</p> <ul style="list-style-type: none"> • an unaligned address on word and halfword memory access • division by zero.
SVCcall	A <i>supervisor call</i> (SVC) is an exception that is triggered by the SVC instruction. In an OS environment, applications can use SVC instructions to access OS kernel functions and device drivers.
PendSV	PendSV is an interrupt-driven request for system-level service. In an OS environment, use PendSV for context switching when no other exception is active.
SysTick	A SysTick exception is an exception the system timer generates when it reaches zero. Software can also generate a SysTick exception. In an OS environment, the processor can use this exception as system tick.
Interrupt (IRQ)	A interrupt, or IRQ, is an exception signalled by a peripheral, or generated by a software request. All interrupts are asynchronous to instruction execution. In the system, peripherals use interrupts to communicate with the processor.

Table 2.15. Properties of the different exception types

Exception number ¹	IRQ number ¹	Exception type	Priority	Vector address or offset ²	Activation
1	-	Reset	-3, the highest	0x00000004	Asynchronous
2	-14	NMI	-2	0x00000008	Software only
3	-13	Hard fault	-1	0x0000000C	-
4	-12	Memory management fault	Configurable ³	0x00000010	Synchronous
5	-11	Bus fault	Configurable ³	0x00000014	Synchronous when precise, asynchronous when imprecise
6	-10	Usage fault	Configurable ³	0x00000018	Synchronous
7-10	-	-	-	Reserved	-
11	-5	SVCcall	Configurable ³	0x0000002C	Synchronous
12-13	-	-	-	Reserved	-
14	-2	PendSV	Configurable ³	0x00000038	Asynchronous
15	-1	SysTick	Configurable ³	0x0000003C	Asynchronous
16 and above	0 and above	Interrupt (IRQ)	Configurable ⁴	0x00000040 and above ⁵	Asynchronous

¹To simplify the software layer, the CMSIS only uses IRQ numbers and therefore uses negative values for exceptions other than interrupts. The IPSR returns the Exception number, see Section 2.1.3.5.2 (p. 10) .

²See Section 2.3.4 (p. 24) for more information.

³See Section 4.3.9 (p. 102) .

⁴See Section 4.2.7 (p. 92) .

⁵Increasing in steps of 4.

For an asynchronous exception, other than reset, the processor can execute another instruction between when the exception is triggered and when the processor enters the exception handler.

Privileged software can disable the exceptions that Table 2.15 (p. 23) shows as having configurable priority, see:

- Section 4.3.10 (p. 103)
- Section 4.2.3 (p. 90) .

For more information about hard faults, memory management faults, bus faults, and usage faults, see Section 2.4 (p. 28) .

2.3.3 Exception handlers

The processor handles exceptions using:

Interrupt Service Routines (ISRs)

Interrupts IRQ0 to IRQ(n-1) (n is given by the number of interrupts for the device, given by Table 1.1 (p. 5)) are the exceptions handled by ISRs.

Fault handlers

Hard fault, memory management fault, usage fault, bus fault are fault exceptions handled by the fault handlers.

System handlers

NMI, PendSV, SVCall SysTick, and the fault exceptions are all system exceptions that are handled by system handlers.

2.3.4 Vector table

The vector table contains the reset value of the stack pointer, and the start addresses, also called exception vectors, for all exception handlers. Figure 2.2 (p. 25) shows the order of the exception vectors in the vector table. The least-significant bit of each vector must be 1, indicating that the exception handler is Thumb code. The parameter n denotes the number of interrupts for the device, given by Table 1.1 (p. 5) .

Figure 2.2. Vector table

Exception number	IRQ number	Offset	Vector
n+ 16	n-1	0x0040+ 4x(n-1)	IRQ(n-1)
.	.	.	.
.	.	.	.
18	2	0x004C	IRQ2
17	1	0x0048	IRQ1
16	0	0x0044	IRQ0
15	-1	0x0040	Systick
14	-2	0x003C	PendSV
13		0x0038	Reserved
12			Reserved for Debug
11	-5	0x002C	SVCall
10			Reserved
9			
8			
7			
6	-10	0x0018	Usage fault
5	-11	0x0014	Bus fault
4	-12	0x0010	Memory management fault
3	-13	0x000C	Hard fault
2	-14	0x0008	NMI
1		0x0004	Reset
		0x0000	Initial SP value

On system reset, the vector table is fixed at address 0x00000000. Privileged software can write to the VTOR to relocate the vector table start address to a different memory location, in the range 0x00000080 to 0x3FFFFFF80, see Section 4.3.5 (p. 98) .

2.3.5 Exception priorities

As Table 2.15 (p. 23) shows, all exceptions have an associated priority, with:

- a lower priority value indicating a higher priority
- configurable priorities for all exceptions except Reset, Hard fault, and NMI.

If software does not configure any priorities, then all exceptions with a configurable priority have a priority of 0. For information about configuring exception priorities see

- Section 4.3.9 (p. 102)
- Section 4.2.7 (p. 92) .

Note

Configurable priority values are in the range 0-7. This means that the Reset, Hard fault, and NMI exceptions, with fixed negative priority values, always have higher priority than any other exception.

For example, assigning a higher priority value to IRQ[0] and a lower priority value to IRQ[1] means that IRQ[1] has higher priority than IRQ[0]. If both IRQ[1] and IRQ[0] are asserted, IRQ[1] is processed before IRQ[0].

If multiple pending exceptions have the same priority, the pending exception with the lowest exception number takes precedence. For example, if both IRQ[0] and IRQ[1] are pending and have the same priority, then IRQ[0] is processed before IRQ[1].

When the processor is executing an exception handler, the exception handler is preempted if a higher priority exception occurs. If an exception occurs with the same priority as the exception being handled, the handler is not preempted, irrespective of the exception number. However, the status of the new interrupt changes to pending.

2.3.6 Interrupt priority grouping

To increase priority control in systems with interrupts, the NVIC supports priority grouping. This divides each interrupt priority register entry into two fields:

- an upper field that defines the *group priority*
- a lower field that defines a *subpriority* within the group.

Only the group priority determines preemption of interrupt exceptions. When the processor is executing an interrupt exception handler, another interrupt with the same group priority as the interrupt being handled does not preempt the handler,

If multiple pending interrupts have the same group priority, the subpriority field determines the order in which they are processed. If multiple pending interrupts have the same group priority and subpriority, the interrupt with the lowest IRQ number is processed first.

For information about splitting the interrupt priority fields into group priority and subpriority, see Section 4.3.6 (p. 99) .

2.3.7 Exception entry and return

Descriptions of exception handling use the following terms:

Preemption	When the processor is executing an exception handler, an exception can preempt the exception handler if its priority is higher than the priority of the exception being handled. See Section 2.3.6 (p. 26) for more information about preemption by an interrupt.
Return	When one exception preempts another, the exceptions are called nested exceptions. See Section 2.3.7.1 (p. 27) more information. This occurs when the exception handler is completed, and: <ul style="list-style-type: none"> • there is no pending exception with sufficient priority to be serviced • the completed exception handler was not handling a late-arriving exception.
Tail-chaining	The processor pops the stack and restores the processor state to the state it had before the interrupt occurred. See Section 2.3.7.2 (p. 27) for more information. This mechanism speeds up exception servicing. On completion of an exception handler, if there is a pending exception that meets the requirements for exception entry, the stack pop is skipped and control transfers to the new exception handler.
Late-arriving	This mechanism speeds up preemption. If a higher priority exception occurs during state saving for a previous exception, the processor switches to handle the higher priority exception and initiates the vector fetch for that exception. State saving is not affected by late arrival because the state saved is the same for both exceptions. Therefore the state saving continues uninterrupted. The processor can accept a late arriving exception until the first instruction of the exception handler of the original

exception enters the execute stage of the processor. On return from the exception handler of the late-arriving exception, the normal tail-chaining rules apply.

2.3.7.1 Exception entry

Exception entry occurs when there is a pending exception with sufficient priority and either:

- the processor is in Thread mode
- the new exception is of higher priority than the exception being handled, in which case the new exception preempts the original exception.

When one exception preempts another, the exceptions are nested.

Sufficient priority means the exception has more priority than any limits set by the mask registers, see Section 2.1.3.6 (p. 11). An exception with less priority than this is pending but is not handled by the processor.

When the processor takes an exception, unless the exception is a tail-chained or a late-arriving exception, the processor pushes information onto the current stack. This operation is referred as *stacking* and the structure of eight data words is referred as *stack frame*. The stack frame contains the following information:

- R0-R3, R12
- Return address
- PSR
- LR.

Immediately after stacking, the stack pointer indicates the lowest address in the stack frame. Unless stack alignment is disabled, the stack frame is aligned to a double-word address. If the STKALIGN bit of the *Configuration Control Register (CCR)* is set to 1, stack align adjustment is performed during stacking.

The stack frame includes the return address. This is the address of the next instruction in the interrupted program. This value is restored to the PC at exception return so that the interrupted program resumes.

In parallel to the stacking operation, the processor performs a vector fetch that reads the exception handler start address from the vector table. When stacking is complete, the processor starts executing the exception handler. At the same time, the processor writes an EXC_RETURN value to the LR. This indicates which stack pointer corresponds to the stack frame and what operation mode the was processor was in before the entry occurred.

If no higher priority exception occurs during exception entry, the processor starts executing the exception handler and automatically changes the status of the corresponding pending interrupt to active.

If another higher priority exception occurs during exception entry, the processor starts executing the exception handler for this exception and does not change the pending status of the earlier exception. This is the late arrival case.

2.3.7.2 Exception return

Exception return occurs when the processor is in Handler mode and executes one of the following instructions to load the EXC_RETURN value into the PC:

- a POP instruction that includes the PC
- a BX instruction with any register.
- an LDR or LDM instruction with the PC as the destination.

EXC_RETURN is the value loaded into the LR on exception entry. The exception mechanism relies on this value to detect when the processor has completed an exception handler. The lowest four bits of

this value provide information on the return stack and processor mode. Table 2.16 (p. 28) shows the EXC_RETURN[3:0] values with a description of the exception return behavior.

The processor sets EXC_RETURN bits[31:4] to 0xFFFFFFFF. When this value is loaded into the PC it indicates to the processor that the exception is complete, and the processor initiates the exception return sequence.

Table 2.16. Exception return behavior

EXC_RETURN[3:0]	Description
bXXX0	Reserved.
b0001	Return to Handler mode. Exception return gets state from MSP. Execution uses MSP after return.
b0011	Reserved.
b01X1	Reserved.
b1001	Return to Thread mode. Exception return gets state from MSP. Execution uses MSP after return.
b1101	Return to Thread mode. Exception return gets state from PSP. Execution uses PSP after return.
b1X11	Reserved.

2.4 Fault handling

Faults are a subset of the exceptions, see Section 2.3 (p. 22) . The following generate a fault:

- a bus error on:
 - an instruction fetch or vector table load
 - a data access
- an internally-detected error such as an undefined instruction or an attempt to change state with a BX instruction
- attempting to execute an instruction from a memory region marked as *Non-Executable* (XN)
- an MPU fault because of a privilege violation or an attempt to access an unmanaged region.

2.4.1 Fault types

Table 2.17 (p. 28) shows the types of fault, the handler used for the fault, the corresponding fault status register, and the register bit that indicates that the fault has occurred. See Section 4.3.11 (p. 105) for more information about the fault status registers.

Table 2.17. Faults

Fault	Handler	Bit name	Fault status register
Bus error on a vector read	Hard fault	VECTTBL	Section 4.3.12 (p. 109)
Fault escalated to a hard fault		FORCED	
MPU mismatch:	Memory management fault	-	-
on instruction access		IACCVIOL ¹	Section 4.3.11.1 (p. 105)
on data access		DACCVIOL	

Fault	Handler	Bit name	Fault status register
during exception stacking		MSTKERR	
during exception unstacking		MUNSKERR	
Bus error:	Bus fault	-	-
during exception stacking		STKERR	Section 4.3.11.2 (p. 107)
during exception unstacking		UNSTKERR	
during instruction prefetch		IBUSERR	
Precise data bus error		PRECISERR	
Imprecise data bus error		IMPRECISERR	
Attempt to access a coprocessor	Usage fault	NOCP	Section 4.3.11.3 (p. 108)
Undefined instruction		UNDEFINSTR	
Attempt to enter an invalid instruction set state ²		INVSTATE	
Invalid EXC_RETURN value		INVPC	
Illegal unaligned load or store		UNALIGNED	
Divide By 0		DIVBYZERO	

¹Occurs on an access to an XN region even if the MPU is disabled, or not included in the device.

²Attempting to use an instruction set other than the Thumb instruction set.

2.4.2 Fault escalation and hard faults

All faults exceptions except for hard fault have configurable exception priority, see Section 4.3.9 (p. 102) . Software can disable execution of the handlers for these faults, see Section 4.3.10 (p. 103) .

Usually, the exception priority, together with the values of the exception mask registers, determines whether the processor enters the fault handler, and whether a fault handler can preempt another fault handler. as described in Section 2.3 (p. 22) .

In some situations, a fault with configurable priority is treated as a hard fault. This is called *priority escalation*, and the fault is described as *escalated to hard fault*. Escalation to hard fault occurs when:

- A fault handler causes the same kind of fault as the one it is servicing. This escalation to hard fault occurs because a fault handler cannot preempt itself because it must have the same priority as the current priority level.
- A fault handler causes a fault with the same or lower priority as the fault it is servicing. This is because the handler for the new fault cannot preempt the currently executing fault handler.
- An exception handler causes a fault for which the priority is the same as or lower than the currently executing exception.
- A fault occurs and the handler for that fault is not enabled.

If a bus fault occurs during a stack push when entering a bus fault handler, the bus fault does not escalate to a hard fault. This means that if a corrupted stack causes a fault, the fault handler executes even though the stack push for the handler failed. The fault handler operates but the stack contents are corrupted.

Note

Only Reset and NMI can preempt the fixed priority hard fault. A hard fault can preempt any exception other than Reset, NMI, or another hard fault.

2.4.3 Fault status registers and fault address registers

The fault status registers indicate the cause of a fault. For bus faults and memory management faults, the fault address register indicates the address accessed by the operation that caused the fault, as shown in Table 2.18 (p. 30) .

Table 2.18. Fault status and fault address registers

Handler	Status register name	Address register name	Register description
Hard fault	HFSR	-	Section 4.3.12 (p. 109)
Memory management fault	MMFSR	MMFAR	Section 4.3.11.1 (p. 105)
			Section 4.3.13 (p. 110)
Bus fault	BFSR	BFAR	Section 4.3.11.2 (p. 107)
			Section 4.3.14 (p. 110)
Usage fault	UFSR	-	Section 4.3.11.3 (p. 108)

2.4.4 Lockup

The processor enters a lockup state if a hard fault occurs when executing the NMI or hard fault handlers. When the processor is in lockup state it does not execute any instructions. The processor remains in lockup state until either:

- it is reset
- an NMI occurs.

Note

If lockup state occurs from the NMI handler a subsequent NMI does not cause the processor to leave lockup state.

2.5 Power management

The Cortex-M3 processor sleep modes reduce power consumption:

- Sleep mode (Energy Mode 1) stops the processor clock
- Deep sleep mode (Energy Mode 2/3) stops the high frequency oscillators and HFPERCLK/HFCORECLK as well as flash memory.

The SLEEPDEEP bit of the SCR selects which sleep mode is used, see Section 4.3.7 (p. 100). For more information about the behavior of the sleep modes see the EMU documentation in the reference manual for the device.

This section describes the mechanisms for entering sleep mode, and the conditions for waking up from sleep mode.

2.5.1 Entering sleep mode

This section describes the mechanisms software can use to put the processor into sleep mode.

The system can generate spurious wakeup events, for example a debug operation wakes up the processor. Therefore software must be able to put the processor back into sleep mode after such an event. A program might have an idle loop to put the processor back to sleep mode.

2.5.1.1 Wait for interrupt

The *wait for interrupt* instruction, `WFI`, causes immediate entry to sleep mode. When the processor executes a `WFI` instruction it stops executing instructions and enters sleep mode. See Section 3.10.12 (p. 86) for more information.

2.5.1.2 Wait for event

The *wait for event* instruction, `WFE`, causes entry to sleep mode conditional on the value of an one-bit event register. When the processor executes a `WFE` instruction, it checks this register:

- if the register is 0 the processor stops executing instructions and enters sleep mode
- if the register is 1 the processor clears the register to 0 and continues executing instructions without entering sleep mode.

See Section 3.10.11 (p. 86) for more information.

If the event register is 1, this indicate that the processor must not enter sleep mode on execution of a WFE instruction. Typically, this is because the processor has executed an SEV instruction, see Section 3.10.9 (p. 85) . Software cannot access this register directly.

2.5.1.3 Sleep-on-exit

If the SLEEPONEXIT bit of the SCR is set to 1, when the processor completes the execution of an exception handler it returns to Thread mode and immediately enters sleep mode. Use this mechanism in applications that only require the processor to run when an exception occurs.

2.5.2 Wakeup from sleep mode

The conditions for the processor to wakeup depend on the mechanism that cause it to enter sleep mode.

2.5.2.1 Wakeup from WFI or sleep-on-exit

Normally, the processor wakes up only when it detects an exception with sufficient priority to cause exception entry.

Some embedded systems might have to execute system restore tasks after the processor wakes up, and before it executes an interrupt handler. To achieve this set the PRIMASK bit to 1 and the FAULTMASK bit to 0. If an interrupt arrives that is enabled and has a higher priority than current exception priority, the processor wakes up but does not execute the interrupt handler until the processor sets PRIMASK to zero. For more information about PRIMASK and FAULTMASK see Section 2.1.3.6 (p. 11) .

2.5.2.2 Wakeup from WFE

The processor wakes up if:

- it detects an exception with sufficient priority to cause exception entry
- in a multiprocessor system, another processor in the system executes an SEV instruction.

In addition, if the SEVONPEND bit in the SCR is set to 1, any new pending interrupt triggers an event and wakes up the processor, even if the interrupt is disabled or has insufficient priority to cause exception entry. For more information about the SCR see Section 4.3.7 (p. 100) .

2.5.3 The Wakeup Interrupt Controller

The *Wakeup Interrupt Controller* (WIC) is a peripheral that can detect an interrupt and wake the processor from deep sleep mode. The WIC is enabled only when the DEEPSLEEP bit in the SCR is set to 1, see Section 4.3.7 (p. 100) .

The WIC is not programmable, and does not have any registers or user interface. It operates entirely from hardware signals.

When the WIC is enabled and the processor enters deep sleep mode, the power management unit in the system can power down most of the Cortex-M3 processor. This has the side effect of stopping the SysTick timer. When the WIC receives an interrupt, it takes a number of clock cycles to wakeup the processor and restore its state, before it can process the interrupt. This means interrupt latency is increased in deep sleep mode.

Note

If the processor detects a connection to a debugger it disables the WIC.

2.5.4 Power management programming hints

ANSI C cannot directly generate the `WFI` and `WFE` instructions. The CMSIS provides the following intrinsic functions for these instructions:

```
void __WFE(void) // Wait for Event

void __WFI(void) // Wait for Interrupt
```

3 The Cortex-M3 Instruction Set

3.1 Instruction set summary

The processor implements a version of the Thumb instruction set. Table 3.1 (p. 33) lists the supported instructions.

Note

In Table 3.1 (p. 33) :

- angle brackets, <>, enclose alternative forms of the operand
- braces, {}, enclose optional operands
- the Operands column is not exhaustive
- Op2 is a flexible second operand that can be either a register or a constant
- most instructions can use an optional condition code suffix.

For more information on the instructions and operands, see the instruction descriptions.

Table 3.1. Cortex-M3 instructions

Mnemonic	Operands	Brief description	Flags	Page
ADC, ADCS	{Rd,} Rn, Op2	Add with Carry	N,Z,C,V	Section 3.5.1 (p. 57)
ADD, ADDS	{Rd,} Rn, Op2	Add	N,Z,C,V	Section 3.5.1 (p. 57)
ADD, ADDW	{Rd,} Rn, #imm12	Add	N,Z,C,V	Section 3.5.1 (p. 57)
ADR	Rd, label	Load PC-relative address	-	Section 3.4.1 (p. 46)
AND, ANDS	{Rd,} Rn, Op2	Logical AND	N,Z,C	Section 3.5.2 (p. 59)
ASR, ASRS	Rd, Rm, <Rs #n>	Arithmetic Shift Right	N,Z,C	Section 3.5.3 (p. 60)
B	label	Branch	-	Section 3.9.1 (p. 74)
BFC	Rd, #lsb, #width	Bit Field Clear	-	Section 3.8.1 (p. 71)
BFI	Rd, Rn, #lsb, #width	Bit Field Insert	-	Section 3.8.1 (p. 71)
BIC, BICS	{Rd,} Rn, Op2	Bit Clear	N,Z,C	Section 3.5.2 (p. 59)
BKPT	#imm	Breakpoint	-	Section 3.10.1 (p. 80)
BL	label	Branch with Link	-	Section 3.9.1 (p. 74)
BLX	Rm	Branch indirect with Link	-	Section 3.9.1 (p. 74)
BX	Rm	Branch indirect	-	Section 3.9.1 (p. 74)
CBNZ	Rn, label	Compare and Branch if Non Zero	-	Section 3.9.2 (p. 75)
CBZ	Rn, label	Compare and Branch if Zero	-	Section 3.9.2 (p. 75)

Mnemonic	Operands	Brief description	Flags	Page
CLREX	-	Clear Exclusive	-	Section 3.4.9 (p. 56)
CLZ	Rd, Rm	Count leading zeros	-	Section 3.5.4 (p. 61)
CMN, CMNS	Rn, Op2	Compare Negative	N,Z,C,V	Section 3.5.5 (p. 62)
CMP, CMPS	Rn, Op2	Compare	N,Z,C,V	Section 3.5.5 (p. 62)
CPSID	iflags	Change Processor State, Disable Interrupts	-	Section 3.10.2 (p. 80)
CPSIE	iflags	Change Processor State, Enable Interrupts	-	Section 3.10.2 (p. 80)
DMB	-	Data Memory Barrier	-	Section 3.10.3 (p. 81)
DSB	-	Data Synchronization Barrier	-	Section 3.10.4 (p. 82)
EOR, EORS	{Rd,} Rn, Op2	Exclusive OR	N,Z,C	Section 3.5.2 (p. 59)
ISB	-	Instruction Synchronization Barrier	-	Section 3.10.5 (p. 82)
IT	-	If#Then condition block	-	Section 3.9.3 (p. 76)
LDM	Rn{!}, reglist	Load Multiple registers, increment after	-	Section 3.4.6 (p. 52)
LDMDB, LDMEA	Rn{!}, reglist	Load Multiple registers, decrement before	-	Section 3.4.6 (p. 52)
LDMFD, LDMIA	Rn{!}, reglist	Load Multiple registers, increment after	-	Section 3.4.6 (p. 52)
LDR	Rt, [Rn, #offset]	Load Register with word	-	Section 3.4 (p. 45)
LDRB, LDRBT	Rt, [Rn, #offset]	Load Register with byte	-	Section 3.4 (p. 45)
LDRD	Rt, Rt2, [Rn, #offset]	Load Register with two bytes	-	Section 3.4.2 (p. 46)
LDREX	Rt, [Rn, #offset]	Load Register Exclusive	-	Section 3.4.8 (p. 54)
LDREXB	Rt, [Rn]	Load Register Exclusive with byte	-	Section 3.4.8 (p. 54)
LDREXH	Rt, [Rn]	Load Register Exclusive with halfword	-	Section 3.4.8 (p. 54)
LDRH, LDRHT	Rt, [Rn, #offset]	Load Register with halfword	-	Section 3.4 (p. 45)
LDRSB, LDRSBT	Rt, [Rn, #offset]	Load Register with signed byte	-	Section 3.4 (p. 45)
LDRSH, LDRSHT	Rt, [Rn, #offset]	Load Register with signed halfword	-	Section 3.4 (p. 45)
LDRT	Rt, [Rn, #offset]	Load Register with word	-	Section 3.4 (p. 45)
LSL, LSLs	Rd, Rm, <Rs #n>	Logical Shift Left	N,Z,C	Section 3.5.3 (p. 60)
LSR, LSRS	Rd, Rm, <Rs #n>	Logical Shift Right	N,Z,C	Section 3.5.3 (p. 60)

Mnemonic	Operands	Brief description	Flags	Page
MLA	Rd, Rn, Rm, Ra	Multiply with Accumulate, 32-bit result	-	Section 3.6.1 (p. 67)
MLS	Rd, Rn, Rm, Ra	Multiply and Subtract, 32-bit result	-	Section 3.6.1 (p. 67)
MOV, MOVS	Rd, Op2	Move	N,Z,C	Section 3.5.6 (p. 62)
MOVT	Rd, #imm16	Move Top	-	Section 3.5.7 (p. 64)
MOVW, MOV	Rd, #imm16	Move 16-bit constant	N,Z,C	Section 3.5.6 (p. 62)
MRS	Rd, spec_reg	Move from special register to general register	-	Section 3.10.6 (p. 83)
MSR	spec_reg, Rm	Move from general register to special register	N,Z,C,V	Section 3.10.7 (p. 83)
MUL, MULS	{Rd,} Rn, Rm	Multiply, 32-bit result	N,Z	Section 3.6.1 (p. 67)
MVN, MVNS	Rd, Op2	Move NOT	N,Z,C	Section 3.5.6 (p. 62)
NOP	-	No Operation	-	Section 3.10.8 (p. 84)
ORN, ORNS	{Rd,} Rn, Op2	Logical OR NOT	N,Z,C	Section 3.5.2 (p. 59)
ORR, ORRS	{Rd,} Rn, Op2	Logical OR	N,Z,C	Section 3.5.2 (p. 59)
POP	reglist	Pop registers from stack	-	Section 3.4.7 (p. 53)
PUSH	reglist	Push registers onto stack	-	Section 3.4.7 (p. 53)
RBIT	Rd, Rn	Reverse Bits	-	Section 3.5.8 (p. 64)
REV	Rd, Rn	Reverse byte order in a word	-	Section 3.5.8 (p. 64)
REV16	Rd, Rn	Reverse byte order in each halfword	-	Section 3.5.8 (p. 64)
REVSH	Rd, Rn	Reverse byte order in bottom halfword and sign extend	-	Section 3.5.8 (p. 64)
ROR, RORS	Rd, Rm, <Rs #n>	Rotate Right	N,Z,C	Section 3.5.3 (p. 60)
RRX, RRXS	Rd, Rm	Rotate Right with Extend	N,Z,C	Section 3.5.3 (p. 60)
RSB, RSBS	{Rd,} Rn, Op2	Reverse Subtract	N,Z,C,V	Section 3.5.1 (p. 57)
SBC, SBSC	{Rd,} Rn, Op2	Subtract with Carry	N,Z,C,V	Section 3.5.1 (p. 57)
SBFX	Rd, Rn, #lsb, #width	Signed Bit Field Extract	-	Section 3.8.2 (p. 72)
SDIV	{Rd,} Rn, Rm	Signed Divide	-	Section 3.6.3 (p. 69)
SEV	-	Send Event	-	Section 3.10.9 (p. 85)
SMLAL	RdLo, RdHi, Rn, Rm	Signed Multiply with Accumulate (32 x 32 + 64), 64-bit result	-	Section 3.6.2 (p. 68)

Mnemonic	Operands	Brief description	Flags	Page
SMULL	RdLo, RdHi, Rn, Rm	Signed Multiply (32 x 32), 64-bit result	-	Section 3.6.2 (p. 68)
SSAT	Rd, #n, Rm {,shift #s}	Signed Saturate	Q	Section 3.7.1 (p. 69)
STM	Rn{!}, reglist	Store Multiple registers, increment after	-	Section 3.4.6 (p. 52)
STMDB, STMEA	Rn{!}, reglist	Store Multiple registers, decrement before	-	Section 3.4.6 (p. 52)
STMPD, STMIA	Rn{!}, reglist	Store Multiple registers, increment after	-	Section 3.4.6 (p. 52)
STR	Rt, [Rn, #offset]	Store Register word	-	Section 3.4 (p. 45)
STRB, STRBT	Rt, [Rn, #offset]	Store Register byte	-	Section 3.4 (p. 45)
STRD	Rt, Rt2, [Rn, #offset]	Store Register two words	-	Section 3.4.2 (p. 46)
STREX	Rd, Rt, [Rn, #offset]	Store Register Exclusive	-	Section 3.4.8 (p. 54)
STREXB	Rd, Rt, [Rn]	Store Register Exclusive byte	-	Section 3.4.8 (p. 54)
STREXH	Rd, Rt, [Rn]	Store Register Exclusive halfword	-	Section 3.4.8 (p. 54)
STRH, STRHT	Rt, [Rn, #offset]	Store Register halfword	-	Section 3.4 (p. 45)
STRT	Rt, [Rn, #offset]	Store Register word	-	Section 3.4 (p. 45)
SUB, SUBS	{Rd,} Rn, Op2	Subtract	N,Z,C,V	Section 3.5.1 (p. 57)
SUB, SUBW	{Rd,} Rn, #imm12	Subtract	N,Z,C,V	Section 3.5.1 (p. 57)
SVC	#imm	Supervisor Call	-	Section 3.10.10 (p. 85)
SXTB	{Rd,} Rm {,ROR #n}	Sign extend a byte	-	Section 3.8.3 (p. 72)
SXTH	{Rd,} Rm {,ROR #n}	Sign extend a halfword	-	Section 3.8.3 (p. 72)
TBB	[Rn, Rm]	Table Branch Byte	-	Section 3.9.4 (p. 78)
TBH	[Rn, Rm, LSL #1]	Table Branch Halfword	-	Section 3.9.4 (p. 78)
TEQ	Rn, Op2	Test Equivalence	N,Z,C	Section 3.5.9 (p. 65)
TST	Rn, Op2	Test	N,Z,C	Section 3.5.9 (p. 65)
UBFX	Rd, Rn, #lsb, #width	Unsigned Bit Field Extract	-	Section 3.8.2 (p. 72)
UDIV	{Rd,} Rn, Rm	Unsigned Divide	-	Section 3.6.3 (p. 69)
UMLAL	RdLo, RdHi, Rn, Rm	Unsigned Multiply with Accumulate (32 x 32 + 64), 64-bit result	-	Section 3.6.2 (p. 68)
UMULL	RdLo, RdHi, Rn, Rm	Unsigned Multiply (32 x 32), 64-bit result	-	Section 3.6.2 (p. 68)

Mnemonic	Operands	Brief description	Flags	Page
USAT	Rd, #n, Rm {,shift #s}	Unsigned Saturate	Q	Section 3.7.1 (p. 69)
UXTB	{Rd,} Rm {,ROR #n}	Zero extend a byte	-	Section 3.8.3 (p. 72)
UXTH	{Rd,} Rm {,ROR #n}	Zero extend a halfword	-	Section 3.8.3 (p. 72)
WFE	-	Wait For Event	-	Section 3.10.11 (p. 86)
WFI	-	Wait For Interrupt	-	Section 3.10.12 (p. 86)

3.2 Intrinsic functions

ANSI cannot directly access some Cortex-M3 instructions. This section describes intrinsic functions that can generate these instructions, provided by the CMSIS and that might be provided by a C compiler. If a C compiler does not support an appropriate intrinsic function, you might have to use inline assembler to access some instructions.

The CMSIS provides the following intrinsic functions to generate instructions that ANSI cannot directly access:

Table 3.2. CMSIS intrinsic functions to generate some Cortex-M3 instructions

Instruction	CMSIS intrinsic function
CPSIE I	void __enable_irq(void)
CPSID I	void __disable_irq(void)
CPSIE F	void __enable_fault_irq(void)
CPSID F	void __disable_fault_irq(void)
ISB	void __ISB(void)
DSB	void __DSB(void)
DMB	void __DMB(void)
REV	uint32_t __REV(uint32_t int value)
REV16	uint32_t __REV16(uint32_t int value)
REVSH	uint32_t __REVSH(uint32_t int value)
RBIT	uint32_t __RBIT(uint32_t int value)
SEV	void __SEV(void)
WFE	void __WFE(void)
WFI	void __WFI(void)

The CMSIS also provides a number of functions for accessing the special registers using MRS and MSR instructions:

Table 3.3. CMSIS intrinsic functions to access the special registers

Special register	Access	CMSIS function
PRIMASK	Read	uint32_t __get_PRIMASK (void)

Special register	Access	CMSIS function
	Write	void __set_PRIMASK (uint32_t value)
FAULTMASK	Read	uint32_t __get_FAULTMASK (void)
	Write	void __set_FAULTMASK (uint32_t value)
BASEPRI	Read	uint32_t __get_BASEPRI (void)
	Write	void __set_BASEPRI (uint32_t value)
CONTROL	Read	uint32_t __get_CONTROL (void)
	Write	void __set_CONTROL (uint32_t value)
MSP	Read	uint32_t __get_MSP (void)
	Write	void __set_MSP (uint32_t TopOfMainStack)
PSP	Read	uint32_t __get_PSP (void)
	Write	void __set_PSP (uint32_t TopOfProcStack)

3.3 About the instruction descriptions

This section gives more information about using the instructions.

3.3.1 Operands

An instruction operand can be an ARM register, a constant, or another instruction-specific parameter. Instructions act on the operands and often store the result in a destination register. When there is a destination register in the instruction, it is usually specified before the operands.

Operands in some instructions are flexible in that they can either be a register or a constant. See Section 3.3.3 (p. 38) .

3.3.2 Restrictions when using PC or SP

Many instructions have restrictions on whether you can use the *Program Counter (PC)* or *Stack Pointer (SP)* for the operands or destination register. See instruction descriptions for more information.

Note

Bit[0] of any address you write to the PC with a BX, BLX, LDM, LDR, or POP instruction must be 1 for correct execution, because this bit indicates the required instruction set, and the Cortex-M3 processor only supports Thumb instructions.

3.3.3 Flexible second operand

Many general data processing instructions have a flexible second operand. This is shown as *Operand2* in the descriptions of the syntax of each instruction.

Operand2 can be a:

- Section 3.3.3.1 (p. 38)
- Section 3.3.3.2 (p. 39)

3.3.3.1 Constant

You specify an *Operand2* constant in the form:

#*constant*

where *constant* can be:

- any constant that can be produced by shifting an 8-bit value left by any number of bits within a 32-bit word
- any constant of the form 0x00XY00XY
- any constant of the form 0xXY00XY00
- any constant of the form 0xXYXYXYXY.

Note

In the constants shown above, X and Y are hexadecimal digits.

In addition, in a small number of instructions, *constant* can take a wider range of values. These are described in the individual instruction descriptions.

When an Operand2 constant is used with the instructions MOV_S, MV_{NS}, AND_S, ORR_S, ORN_S, EOR_S, BIC_S, TEQ or TST, the carry flag is updated to bit[31] of the constant, if the constant is greater than 255 and can be produced by shifting an 8-bit value. These instructions do not affect the carry flag if Operand2 is any other constant.

3.3.3.1 Instruction substitution

Your assembler might be able to produce an equivalent instruction in cases where you specify a constant that is not permitted. For example, an assembler might assemble the instruction `CMP Rd, #0xFFFFFFFFE` as the equivalent instruction `CMN Rd, #0x2`.

3.3.3.2 Register with optional shift

You specify an Operand2 register in the form:

Rm {, *shift*}

where:

<i>Rm</i>	is the register holding the data for the second operand.
<i>shift</i>	is an optional shift to be applied to <i>Rm</i> . It can be one of:
<i>ASR</i> # <i>n</i>	arithmetic shift right <i>n</i> bits, 1 # <i>n</i> # 32.
<i>LSL</i> # <i>n</i>	logical shift left <i>n</i> bits, 1 # <i>n</i> # 31.
<i>LSR</i> # <i>n</i>	logical shift right <i>n</i> bits, 1 # <i>n</i> # 32.
<i>ROR</i> # <i>n</i>	rotate right <i>n</i> bits, 1 # <i>n</i> # 31.
<i>RRX</i>	rotate right one bit, with extend.
-	if omitted, no shift occurs, equivalent to <i>LSL</i> #0.

If you omit the shift, or specify *LSL* #0, the instruction uses the value in *Rm*.

If you specify a shift, the shift is applied to the value in *Rm*, and the resulting 32-bit value is used by the instruction. However, the contents in the register *Rm* remains unchanged. Specifying a register with shift also updates the carry flag when used with certain instructions. For information on the shift operations and how they affect the carry flag, see Section 3.3.4 (p. 39)

3.3.4 Shift Operations

Register shift operations move the bits in a register left or right by a specified number of bits, the *shift length*. Register shift can be performed:

- directly by the instructions `ASR`, `LSR`, `LSL`, `ROR`, and `RRX`, and the result is written to a destination register
- during the calculation of *Operand2* by the instructions that specify the second operand as a register with shift, see Section 3.3.3 (p. 38) . The result is used by the instruction.

The permitted shift lengths depend on the shift type and the instruction, see the individual instruction description or Section 3.3.3 (p. 38). If the shift length is 0, no shift occurs. Register shift operations update the carry flag except when the specified shift length is 0. The following sub-sections describe the various shift operations and how they affect the carry flag. In these descriptions, *Rm* is the register containing the value to be shifted, and *n* is the shift length.

3.3.4.1 ASR

Arithmetic shift right by *n* bits moves the left-hand $32-n$ bits of the register *Rm*, to the right by *n* places, into the right-hand $32-n$ bits of the result. And it copies the original bit[31] of the register into the left-hand *n* bits of the result. See Figure 3.1 (p. 40) .

You can use the `ASR #n` operation to divide the value in the register *Rm* by 2^n , with the result being rounded towards negative-infinity.

When the instruction is `ASRS` or when `ASR #n` is used in *Operand2* with the instructions `MOVS`, `MVNS`, `ANDS`, `ORRS`, `ORNS`, `EORS`, `BICS`, `TEQ` or `TST`, the carry flag is updated to the last bit shifted out, bit[*n*-1], of the register *Rm*.

Note

- If *n* is 32 or more, then all the bits in the result are set to the value of bit[31] of *Rm*.
- If *n* is 32 or more and the carry flag is updated, it is updated to the value of bit[31] of *Rm*.

Figure 3.1. ASR #3

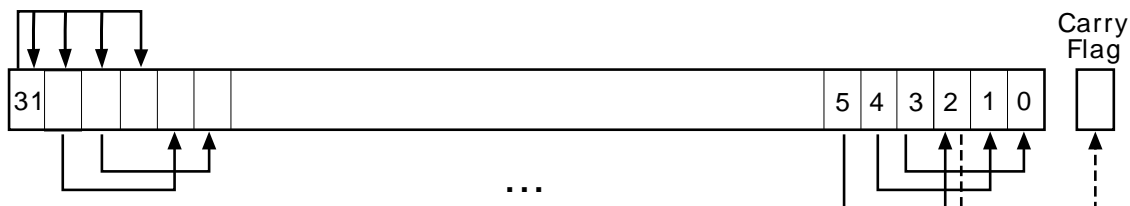

3.3.4.2 LSR

Logical shift right by *n* bits moves the left-hand $32-n$ bits of the register *Rm*, to the right by *n* places, into the right-hand $32-n$ bits of the result. And it sets the left-hand *n* bits of the result to 0. See Figure 3.2 (p. 41) .

You can use the `LSR #n` operation to divide the value in the register *Rm* by 2^n , if the value is regarded as an unsigned integer.

When the instruction is `LSRS` or when `LSR #n` is used in *Operand2* with the instructions `MOVS`, `MVNS`, `ANDS`, `ORRS`, `ORNS`, `EORS`, `BICS`, `TEQ` or `TST`, the carry flag is updated to the last bit shifted out, bit[*n*-1], of the register *Rm*.

Note

- If *n* is 32 or more, then all the bits in the result are cleared to 0.
- If *n* is 33 or more and the carry flag is updated, it is updated to 0.

Figure 3.2. LSR #3

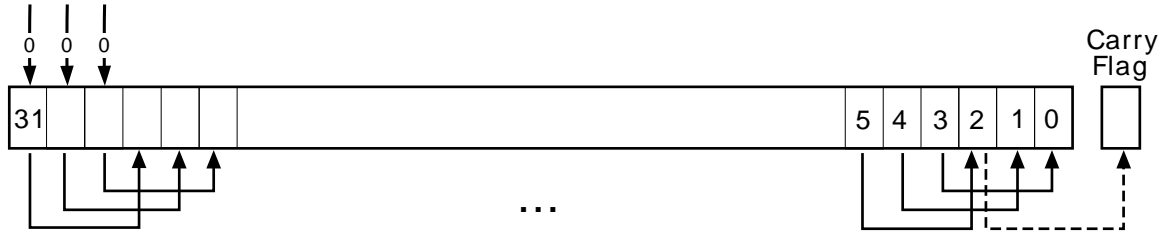

3.3.4.3 LSL

Logical shift left by n bits moves the right-hand $32-n$ bits of the register Rm , to the left by n places, into the left-hand $32-n$ bits of the result. And it sets the right-hand n bits of the result to 0. See Figure 3.3 (p. 41) .

You can use the $LSL \#n$ operation to multiply the value in the register Rm by 2^n , if the value is regarded as an unsigned integer or a two's complement signed integer. Overflow can occur without warning.

When the instruction is $LSLS$ or when $LSL \#n$, with non-zero n , is used in $Operand2$ with the instructions $MOVS$, $MVNS$, $ANDS$, $ORRS$, $ORNS$, $EORS$, $BICS$, TEQ or TST , the carry flag is updated to the last bit shifted out, $bit[32-n]$, of the register Rm . These instructions do not affect the carry flag when used with $LSL \#0$.

Note

- If n is 32 or more, then all the bits in the result are cleared to 0.
- If n is 33 or more and the carry flag is updated, it is updated to 0.

Figure 3.3. LSL #3

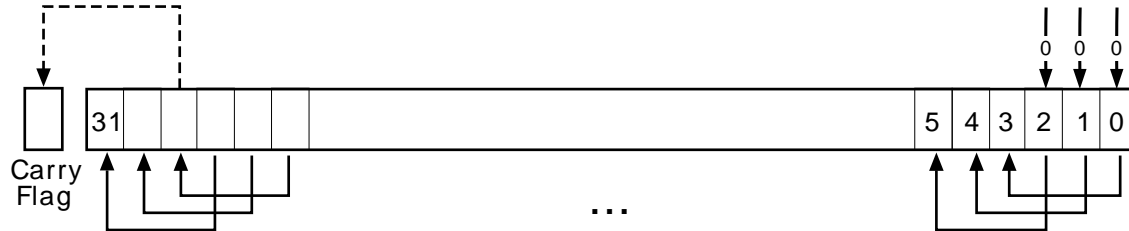

3.3.4.4 ROR

Rotate right by n bits moves the left-hand $32-n$ bits of the register Rm , to the right by n places, into the right-hand $32-n$ bits of the result. And it moves the right-hand n bits of the register into the left-hand n bits of the result. See Figure 3.4 (p. 42) .

When the instruction is $RORS$ or when $ROR \#n$ is used in $Operand2$ with the instructions $MOVS$, $MVNS$, $ANDS$, $ORRS$, $ORNS$, $EORS$, $BICS$, TEQ or TST , the carry flag is updated to the last bit rotation, $bit[n-1]$, of the register Rm .

Note

- If n is 32, then the value of the result is same as the value in Rm , and if the carry flag is updated, it is updated to $bit[31]$ of Rm .
- ROR with shift length, n , more than 32 is the same as ROR with shift length $n-32$.

Figure 3.4. ROR #3

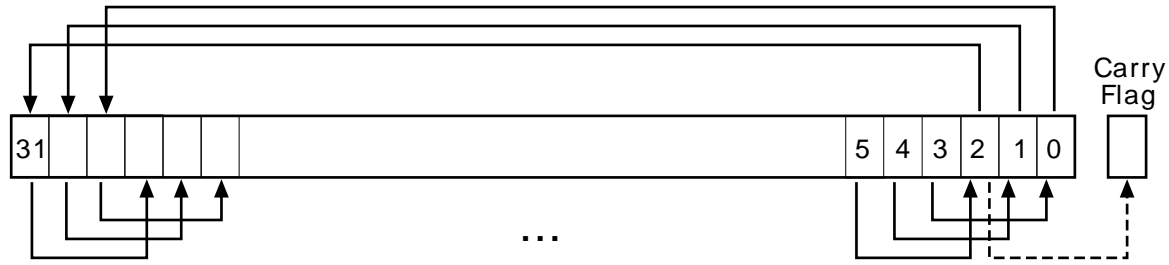

3.3.4.5 RRX

Rotate right with extend moves the bits of the register *Rm* to the right by one bit. And it copies the carry flag into bit[31] of the result. See Figure 3.5 (p. 42) .

When the instruction is RRXS or when *RRX* is used in *Operand2* with the instructions MOV_S, MVNS, AND_S, ORR_S, ORN_S, EORS, BICS, TEQ or TST, the carry flag is updated to bit[0] of the register *Rm*.

Figure 3.5. RRX

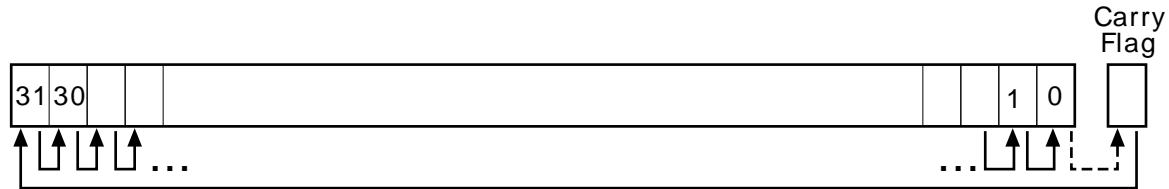

3.3.5 Address alignment

An aligned access is an operation where a word-aligned address is used for a word, dual word, or multiple word access, or where a halfword-aligned address is used for a halfword access. Byte accesses are always aligned.

The Cortex-M3 processor supports unaligned access only for the following instructions:

- LDR, LDRT
- LDRH, LDRHT
- LDRSH, LDRSHT
- STR, STRT
- STRH, STRHT

All other load and store instructions generate a usage fault exception if they perform an unaligned access, and therefore their accesses must be address aligned. For more information about usage faults see Section 2.4 (p. 28) .

Unaligned accesses are usually slower than aligned accesses. In addition, some memory regions might not support unaligned accesses. Therefore, ARM recommends that programmers ensure that accesses are aligned. To avoid accidental generation of unaligned accesses, use the UNALIGN_TRP bit in the Configuration and Control Register to trap all unaligned accesses, see Section 4.3.8 (p. 101) .

3.3.6 PC#relative expressions

A PC#relative expression or *label* is a symbol that represents the address of an instruction or literal data. It is represented in the instruction as the PC value plus or minus a numeric offset. The assembler calculates the required offset from the label and the address of the current instruction. If the offset is too big, the assembler produces an error.

Note

- For B, BL, CBNZ, and CBZ instructions, the value of the PC is the address of the current instruction plus 4 bytes.
- For all other instructions that use labels, the value of the PC is the address of the current instruction plus 4 bytes, with bit[1] of the result cleared to 0 to make it word-aligned.
- Your assembler might permit other syntaxes for PC-relative expressions, such as a label plus or minus a number, or an expression of the form `[PC, #number]`.

3.3.7 Conditional execution

Most data processing instructions can optionally update the condition flags in the *Application Program Status Register* (APSR) according to the result of the operation, see Section 2.1.3.5.1 (p. 9) . Some instructions update all flags, and some only update a subset. If a flag is not updated, the original value is preserved. See the instruction descriptions for the flags they affect.

You can execute an instruction conditionally, based on the condition flags set in another instruction, either:

- immediately after the instruction that updated the flags
- after any number of intervening instructions that have not updated the flags.

Conditional execution is available by using conditional branches or by adding condition code suffixes to instructions. See Table 3.4 (p. 44) for a list of the suffixes to add to instructions to make them conditional instructions. The condition code suffix enables the processor to test a condition based on the flags. If the condition test of a conditional instruction fails, the instruction:

- does not execute
- does not write any value to its destination register
- does not affect any of the flags
- does not generate any exception.

Conditional instructions, except for conditional branches, must be inside an If-Then instruction block. See Section 3.9.3 (p. 76) for more information and restrictions when using the `IT` instruction. Depending on the vendor, the assembler might automatically insert an `IT` instruction if you have conditional instructions outside the IT block.

Use the `CBZ` and `CBNZ` instructions to compare the value of a register against zero and branch on the result.

This section describes:

- Section 3.3.7.1 (p. 43)
- Section 3.3.7.2 (p. 44) .

3.3.7.1 The condition flags

The APSR contains the following condition flags:

- N Set to 1 when the result of the operation was negative, cleared to 0 otherwise.
- Z Set to 1 when the result of the operation was zero, cleared to 0 otherwise.
- C Set to 1 when the operation resulted in a carry, cleared to 0 otherwise.
- V Set to 1 when the operation caused overflow, cleared to 0 otherwise.

For more information about the APSR see Section 2.1.3.5 (p. 8) .

A carry occurs:

- if the result of an addition is greater than or equal to 2^{32}
- if the result of a subtraction is positive or zero
- as the result of an inline barrel shifter operation in a move or logical instruction.

Overflow occurs if the result of an add, subtract, or compare is greater than or equal to 2^{31} , or less than -2^{31} .

Note

Most instructions update the status flags only if the S suffix is specified. See the instruction descriptions for more information.

3.3.7.2 Condition code suffixes

The instructions that can be conditional have an optional condition code, shown in syntax descriptions as *{cond}*. Conditional execution requires a preceding *IT* instruction. An instruction with a condition code is only executed if the condition code flags in the APSR meet the specified condition. Table 3.4 (p. 44) shows the condition codes to use.

You can use conditional execution with the *IT* instruction to reduce the number of branch instructions in code.

Table 3.4 (p. 44) also shows the relationship between condition code suffixes and the N, Z, C, and V flags.

Table 3.4. Condition code suffixes

Suffix	Flags	Meaning
EQ	Z = 1	Equal
NE	Z = 0	Not equal
CS or HS	C = 1	Higher or same, unsigned #
CC or LO	C = 0	Lower, unsigned <
MI	N = 1	Negative
PL	N = 0	Positive or zero
VS	V = 1	Overflow
VC	V = 0	No overflow
HI	C = 1 and Z = 0	Higher, unsigned >
LS	C = 0 or Z = 1	Lower or same, unsigned #
GE	N = V	Greater than or equal, signed #
LT	N != V	Less than, signed <
GT	Z = 0 and N = V	Greater than, signed >
LE	Z = 1 and N != V	Less than or equal, signed #
AL	Can have any value	Always. This is the default when no suffix is specified.

Example 3.1 (p. 44) shows the use of a conditional instruction to find the absolute value of a number. $R0 = \text{ABS}(R1)$.

Example 3.1. Absolute value

```

MOVSN  R0, R1          ; R0 = R1, setting flags
IT      MI             ; IT instruction for the negative condition
RSBMIN R0, R1, #0     ; If negative, R0 = -R1

```

Example 3.2 (p. 45) shows the use of conditional instructions to update the value of R4 if the signed values R0 is greater than R1 and R2 is greater than R3.

Example 3.2. Compare and update value

```
CMP      R0, R1      ; Compare R0 and R1, setting flags
ITT      GT          ; IT instruction for the two GT conditions
CMPGT   R2, R3      ; If 'greater than', compare R2 and R3, setting flags
MOVGT   R4, R5      ; If still 'greater than', do R4 = R5
```

3.3.8 Instruction width selection

There are many instructions that can generate either a 16-bit encoding or a 32-bit encoding depending on the operands and destination register specified. For some of these instructions, you can force a specific instruction size by using an instruction width suffix. The `.w` suffix forces a 32-bit instruction encoding. The `.N` suffix forces a 16-bit instruction encoding.

If you specify an instruction width suffix and the assembler cannot generate an instruction encoding of the requested width, it generates an error.

Note

In some cases it might be necessary to specify the `.w` suffix, for example if the operand is the label of an instruction or literal data, as in the case of branch instructions. This is because the assembler might not automatically generate the right size encoding.

To use an instruction width suffix, place it immediately after the instruction mnemonic and condition code, if any. Example 3.3 (p. 45) shows instructions with the instruction width suffix.

Example 3.3. Instruction width selection

```
BCS.W  label        ; creates a 32-bit instruction even for a short branch

ADDS.W R0, R0, R1   ; creates a 32-bit instruction even though the same
                    ; operation can be done by a 16-bit instruction
```

3.4 Memory access instructions

Table 3.5 (p. 45) shows the memory access instructions:

Table 3.5. Memory access instructions

Mnemonic	Brief description	See
ADR	Load PC-relative address	Section 3.4.1 (p. 46)
CLREX	Clear Exclusive	Section 3.4.9 (p. 56)
LDM{mode}	Load Multiple registers	Section 3.4.6 (p. 52)
LDR{type}	Load Register using immediate offset	Section 3.4.2 (p. 46)
LDR{type}	Load Register using register offset	Section 3.4.3 (p. 48)
LDR{type}T	Load Register with unprivileged access	Section 3.4.4 (p. 50)
LDR	Load Register using PC-relative address	Section 3.4.5 (p. 51)
LDREX{type}	Load Register Exclusive	Section 3.4.8 (p. 54)
POP	Pop registers from stack	Section 3.4.7 (p. 53)
PUSH	Push registers onto stack	Section 3.4.7 (p. 53)
STM{mode}	Store Multiple registers	Section 3.4.6 (p. 52)
STR{type}	Store Register using immediate offset	Section 3.4.2 (p. 46)

Mnemonic	Brief description	See
STR{type}	Store Register using register offset	Section 3.4.3 (p. 48)
STR{type}T	Store Register with unprivileged access	Section 3.4.4 (p. 50)
STREX{type}	Store Register Exclusive	Section 3.4.8 (p. 54)

3.4.1 ADR

Load PC-relative address.

3.4.1.1 Syntax

```
ADR{cond} Rd, label
```

where:

cond is an optional condition code, see Section 3.3.7 (p. 43) .

Rd is the destination register.

label is a PC#relative expression. See Section 3.3.6 (p. 42) .

3.4.1.2 Operation

ADR determines the address by adding an immediate value to the PC, and writes the result to the destination register.

ADR produces position#independent code, because the address is PC#relative.

If you use ADR to generate a target address for a BX or BLX instruction, you must ensure that bit[0] of the address you generate is set to 1 for correct execution.

Values of *label* must be within the range of #4095 to +4095 from the address in the PC.

Note

You might have to use the *.w* suffix to get the maximum offset range or to generate addresses that are not word-aligned. See Section 3.3.8 (p. 45) .

3.4.1.3 Restrictions

Rd must not be SP and must not be PC.

3.4.1.4 Condition flags

This instruction does not change the flags.

3.4.1.5 Examples

```
ADR    R1, TextMessage    ; Write address value of a location labelled as
                        ; TextMessage to R1
```

3.4.2 LDR and STR, immediate offset

Load and Store with immediate offset, pre-indexed immediate offset, or post-indexed immediate offset.

3.4.2.1 Syntax

```
op{type}{cond} Rt, [Rn {, #offset}] ; immediate offset
```

```

op{type}{cond} Rt, [Rn, #offset]!           ; pre-indexed

op{type}{cond} Rt, [Rn], #offset           ; post-indexed

opD{cond} Rt, Rt2, [Rn {, #offset}]        ; immediate offset, two words

opD{cond} Rt, Rt2, [Rn, #offset]!         ; pre-indexed, two words

opD{cond} Rt, Rt2, [Rn], #offset          ; post-indexed, two words

```

where:

op is one of:
LDR Load Register.
STR Store Register.

type is one of:
B unsigned byte, zero extend to 32 bits on loads.
SB signed byte, sign extend to 32 bits (LDR only).
H unsigned halfword, zero extend to 32 bits on loads.
SH signed halfword, sign extend to 32 bits (LDR only).
omit, for word.

cond is an optional condition code, see Section 3.3.7 (p. 43) .

Rt is the register to load or store.

Rn is the register on which the memory address is based.

offset is an offset from *Rn*. If *offset* is omitted, the address is the contents of *Rn*.

Rt2 is the additional register to load or store for two-word operations.

3.4.2.2 Operation

LDR instructions load one or two registers with a value from memory.

STR instructions store one or two register values to memory.

Load and store instructions with immediate offset can use the following addressing modes:

Offset addressing The offset value is added to or subtracted from the address obtained from the register *Rn*. The result is used as the address for the memory access. The register *Rn* is unaltered. The assembly language syntax for this mode is:

Pre-indexed addressing $[Rn, \#offset]$
The offset value is added to or subtracted from the address obtained from the register *Rn*. The result is used as the address for the memory access and written back into the register *Rn*. The assembly language syntax for this mode is:

Post-indexed addressing $[Rn, \#offset]!$
The address obtained from the register *Rn* is used as the address for the memory access. The offset value is added to or subtracted from the address, and written back into the register *Rn*. The assembly language syntax for this mode is:

$[Rn], \#offset$

The value to load or store can be a byte, halfword, word, or two words. Bytes and halfwords can either be signed or unsigned. See Section 3.3.5 (p. 42) .

Table 3.6 (p. 48) shows the ranges of offset for immediate, pre-indexed and post-indexed forms.

Table 3.6. Offset ranges

Instruction type	Immediate offset	Pre-indexed	Post-indexed
Word, halfword, signed halfword, byte, or signed byte	#255 to 4095	#255 to 255	#255 to 255
Two words	multiple of 4 in the range #1020 to 1020	multiple of 4 in the range #1020 to 1020	multiple of 4 in the range #1020 to 1020

3.4.2.3 Restrictions

For load instructions:

- Rt can be SP or PC for word loads only
- Rt must be different from $Rt2$ for two-word loads
- Rn must be different from Rt and $Rt2$ in the pre-indexed or post-indexed forms.

When Rt is PC in a word load instruction:

- bit[0] of the loaded value must be 1 for correct execution
- a branch occurs to the address created by changing bit[0] of the loaded value to 0
- if the instruction is conditional, it must be the last instruction in the IT block.

For store instructions:

- Rt can be SP for word stores only
- Rt must not be PC
- Rn must not be PC
- Rn must be different from Rt and $Rt2$ in the pre-indexed or post-indexed forms.

3.4.2.4 Condition flags

These instructions do not change the flags.

3.4.2.5 Examples

```

LDR    R8, [R10]           ; Loads R8 from the address in R10.
LDRNE  R2, [R5, #960]!    ; Loads (conditionally) R2 from a word
                           ; 960 bytes above the address in R5, and
                           ; increments R5 by 960.

STR    R2, [R9, #const#struc] ; const#struc is an expression evaluating
                           ; to a constant in the range 0#4095.
STRH   R3, [R4], #4       ; Store R3 as halfword data into address in
                           ; R4, then increment R4 by 4
LDRD   R8, R9, [R3, #0x20] ; Load R8 from a word 32 bytes above the
                           ; address in R3, and load R9 from a word 36
                           ; bytes above the address in R3
STRD   R0, R1, [R8], #-16 ; Store R0 to address in R8, and store R1 to
                           ; a word 4 bytes above the address in R8,
                           ; and then decrement R8 by 16.

```

3.4.3 LDR and STR, register offset

Load and Store with register offset.

3.4.3.1 Syntax

```
op{type}{cond} Rt, [Rn, Rm {, LSL #n}]
```

where:

op is one of:

LDR Load Register.

STR Store Register.

type is one of:

B unsigned byte, zero extend to 32 bits on loads.

SB signed byte, sign extend to 32 bits (LDR only).

H unsigned halfword, zero extend to 32 bits on loads.

SH signed halfword, sign extend to 32 bits (LDR only).

omit, for word.

cond is an optional condition code, see Section 3.3.7 (p. 43) .

Rt is the register to load or store.

Rn is the register on which the memory address is based.

Rm is a register containing a value to be used as the offset.

LSL #n is an optional shift, with *n* in the range 0 to 3.

3.4.3.2 Operation

LDR instructions load a register with a value from memory.

STR instructions store a register value into memory.

The memory address to load from or store to is at an offset from the register *Rn*. The offset is specified by the register *Rm* and can be shifted left by up to 3 bits using LSL.

The value to load or store can be a byte, halfword, or word. For load instructions, bytes and halfwords can either be signed or unsigned. See Section 3.3.5 (p. 42) .

3.4.3.3 Restrictions

In these instructions:

- *Rn* must not be PC
- *Rm* must not be SP and must not be PC
- *Rt* can be SP only for word loads and word stores
- *Rt* can be PC only for word loads.

When *Rt* is PC in a word load instruction:

- bit[0] of the loaded value must be 1 for correct execution, and a branch occurs to this halfword-aligned address
- if the instruction is conditional, it must be the last instruction in the IT block.

3.4.3.4 Condition flags

These instructions do not change the flags.

3.4.3.5 Examples

```
STR    R0, [R5, R1]    ; Store value of R0 into an address equal to
                       ; sum of R5 and R1
```

```

LDRSB R0, [R5, R1, LSL #1] ; Read byte value from an address equal to
                           ; sum of R5 and two times R1, sign extended it
                           ; to a word value and put it in R0
STR    R0, [R1, R2, LSL #2] ; Stores R0 to an address equal to sum of R1
                           ; and four times R2

```

3.4.4 LDR and STR, unprivileged

Load and Store with unprivileged access.

3.4.4.1 Syntax

```

op{type}T{cond} Rt, [Rn {, #offset}] ; immediate offset

```

where:

op is one of:

LDR Load Register.

STR Store Register.

type is one of:

B unsigned byte, zero extend to 32 bits on loads.

SB signed byte, sign extend to 32 bits (*LDR* only).

H unsigned halfword, zero extend to 32 bits on loads.

SH signed halfword, sign extend to 32 bits (*LDR* only).

omit, for word.

cond is an optional condition code, see Section 3.3.7 (p. 43) .

Rt is the register to load or store.

Rn is the register on which the memory address is based.

offset is an offset from *Rn* and can be 0 to 255. If *offset* is omitted, the address is the value in *Rn*.

3.4.4.2 Operation

These load and store instructions perform the same function as the memory access instructions with immediate offset, see Section 3.4.2 (p. 46) . The difference is that these instructions have only unprivileged access even when used in privileged software.

When used in unprivileged software, these instructions behave in exactly the same way as normal memory access instructions with immediate offset.

3.4.4.3 Restrictions

In these instructions:

- *Rn* must not be PC
- *Rt* must not be SP and must not be PC.

3.4.4.4 Condition flags

These instructions do not change the flags.

3.4.4.5 Examples

```

STRBTEQ R4, [R7] ; Conditionally store least significant byte in
                 ; R4 to an address in R7, with unprivileged access
LDRHT R2, [R2, #8] ; Load halfword value from an address equal to
                 ; sum of R2 and 8 into R2, with unprivileged access

```

3.4.5 LDR, PC#relative

Load register from memory.

3.4.5.1 Syntax

```
LDR{type}{cond} Rt, label
```

```
LDRD{cond} Rt, Rt2, label ; Load two words
```

where:

type is one of:

- B* unsigned byte, zero extend to 32 bits.
- SB* signed byte, sign extend to 32 bits.
- H* unsigned halfword, zero extend to 32 bits.
- SH* signed halfword, sign extend to 32 bits.
- #* omit, for word.

cond is an optional condition code, see Section 3.3.7 (p. 43) .

Rt is the register to load or store.

Rt2 is the second register to load or store.

label is a PC#relative expression. See Section 3.3.6 (p. 42) .

3.4.5.2 Operation

LDR loads a register with a value from a PC-relative memory address. The memory address is specified by a label or by an offset from the PC.

The value to load or store can be a byte, halfword, or word. For load instructions, bytes and halfwords can either be signed or unsigned. See Section 3.3.5 (p. 42) .

label must be within a limited range of the current instruction. Table 3.7 (p. 51) shows the possible offsets between *label* and the PC.

Table 3.7. Offset ranges

Instruction type	Offset range
Word, halfword, signed halfword, byte, signed byte	#4095 to 4095
Two words	#1020 to 1020

Note

You might have to use the *.W* suffix to get the maximum offset range. See Section 3.3.8 (p. 45) .

3.4.5.3 Restrictions

In these instructions:

- *Rt* can be SP or PC only for word loads
- *Rt2* must not be SP and must not be PC
- *Rt* must be different from *Rt2* .

When *Rt* is PC in a word load instruction:

- bit[0] of the loaded value must be 1 for correct execution, and a branch occurs to this halfword-aligned address

- if the instruction is conditional, it must be the last instruction in the IT block.

3.4.5.4 Condition flags

These instructions do not change the flags.

3.4.5.5 Examples

```
LDR    R0, LookUpTable    ; Load R0 with a word of data from an address
                          ; labelled as LookUpTable
LDRSB  R7, localdata      ; Load a byte value from an address labelled
                          ; as localdata, sign extend it to a word
                          ; value, and put it in R7
```

3.4.6 LDM and STM

Load and Store Multiple registers.

3.4.6.1 Syntax

```
op{addr_mode}{cond} Rn{!}, reglist
```

where:

op is one of:

LDM Load Multiple registers.

STM Store Multiple registers.

addr_mode is any one of the following:

IA Increment address After each access. This is the default.

DB Decrement address Before each access.

cond is an optional condition code, see Section 3.3.7 (p. 43) .

Rn is the register on which the memory addresses are based.

! is an optional writeback suffix. If *!* is present the final address, that is loaded from or stored to, is written back into *Rn*.

reglist is a list of one or more registers to be loaded or stored, enclosed in braces. It can contain register ranges. It must be comma separated if it contains more than one register or register range, see Section 3.4.6.5 (p. 53) .

LDM and LDMFD are synonyms for LDMIA. LDMFD refers to its use for popping data from Full Descending stacks.

LDMEA is a synonym for LDMDB, and refers to its use for popping data from Empty Ascending stacks.

STM and STMEA are synonyms for STMIA. STMEA refers to its use for pushing data onto Empty Ascending stacks.

STMFD is s synonym for STMDB, and refers to its use for pushing data onto Full Descending stacks

3.4.6.2 Operation

LDM instructions load the registers in *reglist* with word values from memory addresses based on *Rn*.

STM instructions store the word values in the registers in *reglist* to memory addresses based on *Rn*.

For LDM, LDMIA, LDMFD, STM, STMIA, and STMEA the memory addresses used for the accesses are at 4-byte intervals ranging from *Rn* to *Rn + 4 * (n-1)*, where *n* is the number of registers in *reglist*. The accesses happens in order of increasing register numbers, with the lowest numbered register using

the lowest memory address and the highest number register using the highest memory address. If the writeback suffix is specified, the value of $R_n + 4 * (n-1)$ is written back to R_n .

For LDMDB, LDMEA, STMDB, and STMFD the memory addresses used for the accesses are at 4-byte intervals ranging from R_n to $R_n - 4 * (n-1)$, where n is the number of registers in *reglist*. The accesses happen in order of decreasing register numbers, with the highest numbered register using the highest memory address and the lowest number register using the lowest memory address. If the writeback suffix is specified, the value of $R_n - 4 * (n-1)$ is written back to R_n .

The PUSH and POP instructions can be expressed in this form. See Section 3.4.7 (p. 53) for details.

3.4.6.3 Restrictions

In these instructions:

- R_n must not be PC
- *reglist* must not contain SP
- in any STM instruction, *reglist* must not contain PC
- in any LDM instruction, *reglist* must not contain PC if it contains LR
- *reglist* must not contain R_n if you specify the writeback suffix.

When PC is in *reglist* in an LDM instruction:

- bit[0] of the value loaded to the PC must be 1 for correct execution, and a branch occurs to this halfword-aligned address
- if the instruction is conditional, it must be the last instruction in the IT block.

3.4.6.4 Condition flags

These instructions do not change the flags.

3.4.6.5 Examples

```
LDM    R8, {R0,R2,R9}      ; LDMIA is a synonym for LDM
STMDB  R1!, {R3#R6,R11,R12}
```

3.4.6.6 Incorrect examples

```
STM    R5!, {R5,R4,R9} ; Value stored for R5 is unpredictable
LDM    R2, {}          ; There must be at least one register in the list
```

3.4.7 PUSH and POP

Push registers onto, and pop registers off a full-descending stack.

3.4.7.1 Syntax

```
PUSH{cond} reglist
```

```
POP{cond} reglist
```

where:

cond is an optional condition code, see Section 3.3.7 (p. 43) .

reglist is a non-empty list of registers, enclosed in braces. It can contain register ranges. It must be comma separated if it contains more than one register or register range.

PUSH and POP are synonyms for STMDB and LDM (or LDMIA) with the memory addresses for the access based on SP, and with the final address for the access written back to the SP. PUSH and POP are the preferred mnemonics in these cases.

3.4.7.2 Operation

PUSH stores registers on the stack in order of decreasing the register numbers, with the highest numbered register using the highest memory address and the lowest numbered register using the lowest memory address.

POP loads registers from the stack in order of increasing register numbers, with the lowest numbered register using the lowest memory address and the highest numbered register using the highest memory address.

See Section 3.4.6 (p. 52) for more information.

3.4.7.3 Restrictions

In these instructions:

- *reglist* must not contain SP
- for the PUSH instruction, *reglist* must not contain PC
- for the POP instruction, *reglist* must not contain PC if it contains LR.

When PC is in *reglist* in a POP instruction:

- bit[0] of the value loaded to the PC must be 1 for correct execution, and a branch occurs to this halfword-aligned address
- if the instruction is conditional, it must be the last instruction in the IT block.

3.4.7.4 Condition flags

These instructions do not change the flags.

3.4.7.5 Examples

```
PUSH    {R0,R4#R7}
PUSH    {R2,LR}
POP     {R0,R10,PC}
```

3.4.8 LDREX and STREX

Load and Store Register Exclusive.

3.4.8.1 Syntax

```
LDREX{cond} Rt, [Rn {, #offset}]
```

```
STREX{cond} Rd, Rt, [Rn {, #offset}]
```

```
LDREXB{cond} Rt, [Rn]
```

```
STREXB{cond} Rd, Rt, [Rn]
```

```
LDREXH{cond} Rt, [Rn]
```

```
STREXH{cond} Rd, Rt, [Rn]
```

where:

cond is an optional condition code, see Section 3.3.7 (p. 43) .
Rd is the destination register for the returned status.
Rt is the register to load or store.
Rn is the register on which the memory address is based.
offset is an optional offset applied to the value in *Rn*. If *offset* is omitted, the address is the value in *Rn*.

3.4.8.2 Operation

LDREX, LDREXB, and LDREXH load a word, byte, and halfword respectively from a memory address.

STREX, STREXB, and STREXH attempt to store a word, byte, and halfword respectively to a memory address. The address used in any Store-Exclusive instruction must be the same as the address in the most recently executed Load-exclusive instruction. The value stored by the Store-Exclusive instruction must also have the same data size as the value loaded by the preceding Load-exclusive instruction. This means software must always use a Load-exclusive instruction and a matching Store-Exclusive instruction to perform a synchronization operation, see Section 2.2.7 (p. 20)

If an Store-Exclusive instruction performs the store, it writes 0 to its destination register. If it does not perform the store, it writes 1 to its destination register. If the Store-Exclusive instruction writes 0 to the destination register, it is guaranteed that no other process in the system has accessed the memory location between the Load-exclusive and Store-Exclusive instructions.

For reasons of performance, keep the number of instructions between corresponding Load-Exclusive and Store-Exclusive instruction to a minimum.

Note

The result of executing a Store-Exclusive instruction to an address that is different from that used in the preceding Load-Exclusive instruction is unpredictable.

3.4.8.3 Restrictions

In these instructions:

- do not use PC
- do not use SP for *Rd* and *Rt*
- for STREX, *Rd* must be different from both *Rt* and *Rn*
- the value of *offset* must be a multiple of four in the range 0-1020.

3.4.8.4 Condition flags

These instructions do not change the flags.

3.4.8.5 Examples

```
MOV    R1, #0x1           ; Initialize the 'lock taken' value
try
LDREX  R0, [LockAddr]    ; Load the lock value
CMP    R0, #0            ; Is the lock free?
ITT    EQ                ; IT instruction for STREXEQ and CMPEQ
STREXEQ R0, R1, [LockAddr] ; Try and claim the lock
CMPEQ  R0, #0            ; Did this succeed?
BNE    try               ; No - try again
....                    ; Yes - we have the lock
```

3.4.9 CLREX

Clear Exclusive.

3.4.9.1 Syntax

CLREX{*cond*}

where:

cond is an optional condition code, see Section 3.3.7 (p. 43) .

3.4.9.2 Operation

Use CLREX to make the next STREX, STREXB, or STREXH instruction write 1 to its destination register and fail to perform the store. It is useful in exception handler code to force the failure of the store exclusive if the exception occurs between a load exclusive instruction and the matching store exclusive instruction in a synchronization operation.

See Section 2.2.7 (p. 20) for more information.

3.4.9.3 Condition flags

These instructions do not change the flags.

3.4.9.4 Examples

CLREX

3.5 General data processing instructions

Table 3.8 (p. 56) shows the data processing instructions:

Table 3.8. Data processing instructions

Mnemonic	Brief description	See
ADC	Add with Carry	Section 3.5.1 (p. 57)
ADD	Add	Section 3.5.1 (p. 57)
ADDW	Add	Section 3.5.1 (p. 57)
AND	Logical AND	Section 3.5.2 (p. 59)
ASR	Arithmetic Shift Right	Section 3.5.3 (p. 60)
BIC	Bit Clear	Section 3.5.2 (p. 59)
CLZ	Count leading zeros	Section 3.5.4 (p. 61)
CMN	Compare Negative	Section 3.5.5 (p. 62)
CMP	Compare	Section 3.5.5 (p. 62)
EOR	Exclusive OR	Section 3.5.2 (p. 59)
LSL	Logical Shift Left	Section 3.5.3 (p. 60)
LSR	Logical Shift Right	Section 3.5.3 (p. 60)
MOV	Move	Section 3.5.6 (p. 62)
MOVT	Move Top	Section 3.5.7 (p. 64)
MOVW	Move 16-bit constant	Section 3.5.6 (p. 62)

Mnemonic	Brief description	See
MVN	Move NOT	Section 3.5.6 (p. 62)
ORN	Logical OR NOT	Section 3.5.2 (p. 59)
ORR	Logical OR	Section 3.5.2 (p. 59)
RBIT	Reverse Bits	Section 3.5.8 (p. 64)
REV	Reverse byte order in a word	Section 3.5.8 (p. 64)
REV16	Reverse byte order in each halfword	Section 3.5.8 (p. 64)
REVSH	Reverse byte order in bottom halfword and sign extend	Section 3.5.8 (p. 64)
ROR	Rotate Right	Section 3.5.3 (p. 60)
RRX	Rotate Right with Extend	Section 3.5.3 (p. 60)
RSB	Reverse Subtract	Section 3.5.1 (p. 57)
SBC	Subtract with Carry	Section 3.5.1 (p. 57)
SUB	Subtract	Section 3.5.1 (p. 57)
SUBW	Subtract	Section 3.5.1 (p. 57)
TEQ	Test Equivalence	Section 3.5.9 (p. 65)
TST	Test	Section 3.5.9 (p. 65)

3.5.1 ADD, ADC, SUB, SBC, and RSB

Add, Add with carry, Subtract, Subtract with carry, and Reverse Subtract.

3.5.1.1 Syntax

$op\{S\}\{cond\} \{Rd,\} Rn, Operand2$

$op\{cond\} \{Rd,\} Rn, \#imm12$; ADD and SUB only

where:

op is one of:
 ADD Add.
 ADC Add with Carry.
 SUB Subtract.
 SBC Subtract with Carry.
 RSB Reverse Subtract.

S is an optional suffix. If S is specified, the condition code flags are updated on the result of the operation, see Section 3.3.7 (p. 43) .

$cond$ is an optional condition code, see Section 3.3.7 (p. 43) .

Rd is the destination register. If Rd is omitted, the destination register is Rn .

Rn is the register holding the first operand.

$Operand2$ is a flexible second operand. See Section 3.3.3 (p. 38) for details of the options.

$imm12$ is any value in the range 0-4095.

3.5.1.2 Operation

The ADD instruction adds the value of $Operand2$ or $imm12$ to the value in Rn .

The ADC instruction adds the values in Rn and $Operand2$, together with the carry flag.

The SUB instruction subtracts the value of $Operand2$ or $imm12$ from the value in Rn .

The `SBC` instruction subtracts the value of `Operand2` from the value in `Rn`. If the carry flag is clear, the result is reduced by one.

The `RSB` instruction subtracts the value in `Rn` from the value of `Operand2`. This is useful because of the wide range of options for `Operand2`.

Use `ADC` and `SBC` to synthesize multiword arithmetic, see Section 3.5.1.6 (p. 59) .

See also Section 3.4.1 (p. 46) .

Note

`ADDW` is equivalent to the `ADD` syntax that uses the `imm12` operand. `SUBW` is equivalent to the `SUB` syntax that uses the `imm12` operand.

3.5.1.3 Restrictions

In these instructions:

- `Operand2` must not be `SP` and must not be `PC`
- `Rd` can be `SP` only in `ADD` and `SUB`, and only with the additional restrictions:
 - `Rn` must also be `SP`
 - any shift in `Operand2` must be limited to a maximum of 3 bits using `LSL`
- `Rn` can be `SP` only in `ADD` and `SUB`
- `Rd` can be `PC` only in the `ADD{cond} PC, PC, Rm` instruction where:
 - you must not specify the `S` suffix
 - `Rm` must not be `PC` and must not be `SP`
 - if the instruction is conditional, it must be the last instruction in the `IT` block
- with the exception of the `ADD{cond} PC, PC, Rm` instruction, `Rn` can be `PC` only in `ADD` and `SUB`, and only with the additional restrictions:
 - you must not specify the `S` suffix
 - the second operand must be a constant in the range 0 to 4095.

Note

- When using the `PC` for an addition or a subtraction, bits[1:0] of the `PC` are rounded to `b00` before performing the calculation, making the base address for the calculation word-aligned.
- If you want to generate the address of an instruction, you have to adjust the constant based on the value of the `PC`. ARM recommends that you use the `ADR` instruction instead of `ADD` or `SUB` with `Rn` equal to the `PC`, because your assembler automatically calculates the correct constant for the `ADR` instruction.

When `Rd` is `PC` in the `ADD{cond} PC, PC, Rm` instruction:

- bit[0] of the value written to the `PC` is ignored
- a branch occurs to the address created by forcing bit[0] of that value to 0.

3.5.1.4 Condition flags

If `S` is specified, these instructions update the `N`, `Z`, `C` and `V` flags according to the result.

3.5.1.5 Examples

```

ADD    R2, R1, R3
SUBS   R8, R6, #240      ; Sets the flags on the result
RSB    R4, R4, #1280     ; Subtracts contents of R4 from 1280
ADCHI  R11, R0, R3      ; Only executed if C flag set and Z
                               ; flag clear

```

3.5.1.6 Multiword arithmetic examples

Example 3.4 (p. 59) shows two instructions that add a 64#bit integer contained in *R2* and *R3* to another 64#bit integer contained in *R0* and *R1*, and place the result in *R4* and *R5*.

Example 3.4. 64-bit addition

```
ADDS    R4, R0, R2    ; add the least significant words
ADC     R5, R1, R3    ; add the most significant words with carry
```

Multiword values do not have to use consecutive registers. Example 3.5 (p. 59) shows instructions that subtract a 96#bit integer contained in *R9*, *R1*, and *R11* from another contained in *R6*, *R2*, and *R8*. The example stores the result in *R6*, *R9*, and *R2*.

Example 3.5. 96-bit subtraction

```
SUBS    R6, R6, R9    ; subtract the least significant words
SBCS    R9, R2, R1    ; subtract the middle words with carry
SBC     R2, R8, R11   ; subtract the most significant words with carry
```

3.5.2 AND, ORR, EOR, BIC, and ORN

Logical AND, OR, Exclusive OR, Bit Clear, and OR NOT.

3.5.2.1 Syntax

```
op{S}{cond} {Rd,} Rn, Operand2
```

where:

op is one of:
 AND logical AND.
 ORR logical OR, or bit set.
 EOR logical Exclusive OR.
 BIC logical AND NOT, or bit clear.
 ORN logical OR NOT.

S is an optional suffix. If *S* is specified, the condition code flags are updated on the result of the operation, see Section 3.3.7 (p. 43) .

cond is an optional condition code, see Section 3.3.7 (p. 43) .

Rd is the destination register.

Rn is the register holding the first operand.

Operand2 is a flexible second operand. See Section 3.3.3 (p. 38) for details of the options.

3.5.2.2 Operation

The AND, EOR, and ORR instructions perform bitwise AND, Exclusive OR, and OR operations on the values in *Rn* and *Operand2*.

The BIC instruction performs an AND operation on the bits in *Rn* with the complements of the corresponding bits in the value of *Operand2*.

The ORN instruction performs an OR operation on the bits in *Rn* with the complements of the corresponding bits in the value of *Operand2*.

3.5.2.3 Restrictions

Do not use SP and do not use PC.

3.5.2.4 Condition flags

If *S* is specified, these instructions:

- update the N and Z flags according to the result
- can update the C flag during the calculation of *Operand2*, see Section 3.3.3 (p. 38)
- do not affect the V flag.

3.5.2.5 Examples

```

AND      R9, R2, #0xFF00
ORREQ    R2, R0, R5
ANDS     R9, R8, #0x19
EORS     R7, R11, #0x18181818
BIC      R0, R1, #0xab
ORN      R7, R11, R14, ROR #4
ORNS     R7, R11, R14, ASR #32

```

3.5.3 ASR, LSL, LSR, ROR, and RRX

Arithmetic Shift Right, Logical Shift Left, Logical Shift Right, Rotate Right, and Rotate Right with Extend.

3.5.3.1 Syntax

op{*S*}{*cond*} *Rd*, *Rm*, *Rs*

op{*S*}{*cond*} *Rd*, *Rm*, #*n*

RRX{*S*}{*cond*} *Rd*, *Rm*

where:

op is one of:

- ASR Arithmetic Shift Right.
- LSL Logical Shift Left.
- LSR Logical Shift Right.
- ROR Rotate Right.

S is an optional suffix. If *S* is specified, the condition code flags are updated on the result of the operation, see Section 3.3.7 (p. 43) .

Rd is the destination register.

Rm is the register holding the value to be shifted.

Rs is the register holding the shift length to apply to the value in *Rm*. Only the least significant byte is used and can be in the range 0 to 255.

n is the shift length. The range of shift length depends on the instruction:

- ASR shift length from 1 to 32
- LSL shift length from 0 to 31
- LSR shift length from 1 to 32
- ROR shift length from 1 to 31.

Note

MOV{*S*}{*cond*} *Rd*, *Rm* is the preferred syntax for LSL{*S*}{*cond*} *Rd*, *Rm*, #0.

3.5.3.2 Operation

ASR, LSL, LSR, and ROR move the bits in the register *Rm* to the left or right by the number of places specified by constant *n* or register *Rs*.

RRX moves the bits in register Rm to the right by 1.

In all these instructions, the result is written to Rd , but the value in register Rm remains unchanged. For details on what result is generated by the different instructions, see Section 3.3.4 (p. 39) .

3.5.3.3 Restrictions

Do not use SP and do not use PC.

3.5.3.4 Condition flags

If S is specified:

- these instructions update the N and Z flags according to the result
- the C flag is updated to the last bit shifted out, except when the shift length is 0, see Section 3.3.4 (p. 39) .

3.5.3.5 Examples

```
ASR    R7, R8, #9 ; Arithmetic shift right by 9 bits
LSLS   R1, R2, #3 ; Logical shift left by 3 bits with flag update
LSR    R4, R5, #6 ; Logical shift right by 6 bits
ROR    R4, R5, R6 ; Rotate right by the value in the bottom byte of R6
RRX    R4, R5     ; Rotate right with extend
```

3.5.4 CLZ

Count Leading Zeros.

3.5.4.1 Syntax

```
CLZ{cond} Rd, Rm
```

where:

cond is an optional condition code, see Section 3.3.7 (p. 43) .
 Rd is the destination register.
 Rm is the operand register.

3.5.4.2 Operation

The CLZ instruction counts the number of leading zeros in the value in Rm and returns the result in Rd . The result value is 32 if no bits are set in the source register, and zero if bit[31] is set.

3.5.4.3 Restrictions

Do not use SP and do not use PC.

3.5.4.4 Condition flags

This instruction does not change the flags.

3.5.4.5 Examples

```
CLZ    R4, R9
CLZNE  R2, R3
```

3.5.5 CMP and CMN

Compare and Compare Negative.

3.5.5.1 Syntax

```
CMP{cond} Rn, Operand2
```

```
CMN{cond} Rn, Operand2
```

where:

cond is an optional condition code, see Section 3.3.7 (p. 43) .

Rn is the register holding the first operand.

Operand2 is a flexible second operand. See Section 3.3.3 (p. 38) for details of the options.

3.5.5.2 Operation

These instructions compare the value in a register with *Operand2*. They update the condition flags on the result, but do not write the result to a register.

The *CMP* instruction subtracts the value of *Operand2* from the value in *Rn*. This is the same as a *SUBS* instruction, except that the result is discarded.

The *CMN* instruction adds the value of *Operand2* to the value in *Rn*. This is the same as an *ADDS* instruction, except that the result is discarded.

3.5.5.3 Restrictions

In these instructions:

- do not use PC
- *Operand2* must not be SP.

3.5.5.4 Condition flags

These instructions update the N, Z, C and V flags according to the result.

3.5.5.5 Examples

```
CMP    R2, R9
CMN    R0, #6400
CMPGT  SP, R7, LSL #2
```

3.5.6 MOV and MVN

Move and Move NOT.

3.5.6.1 Syntax

```
MOV{S}{cond} Rd, Operand2
```

```
MOV{cond} Rd, #imm16
```

```
MVN{S}{cond} Rd, Operand2
```

where:

- S* is an optional suffix. If *S* is specified, the condition code flags are updated on the result of the operation, see Section 3.3.7 (p. 43) .
- cond* is an optional condition code, see Section 3.3.7 (p. 43) .
- Rd* is the destination register.
- Operand2* is a flexible second operand. See Section 3.3.3 (p. 38) for details of the options.
- imm16* is any value in the range 0-65535.

3.5.6.2 Operation

The MOV instruction copies the value of *Operand2* into *Rd*.

When *Operand2* in a MOV instruction is a register with a shift other than *LSL #0*, the preferred syntax is the corresponding shift instruction:

- `ASR{S}{cond} Rd, Rm, #n` is the preferred syntax for `MOV{S}{cond} Rd, Rm, ASR #n`
- `LSL{S}{cond} Rd, Rm, #n` is the preferred syntax for `MOV{S}{cond} Rd, Rm, LSL #n` if *n* != 0
- `LSR{S}{cond} Rd, Rm, #n` is the preferred syntax for `MOV{S}{cond} Rd, Rm, LSR #n`
- `ROR{S}{cond} Rd, Rm, #n` is the preferred syntax for `MOV{S}{cond} Rd, Rm, ROR #n`
- `RRX{S}{cond} Rd, Rm` is the preferred syntax for `MOV{S}{cond} Rd, Rm, RRX`.

Also, the MOV instruction permits additional forms of *Operand2* as synonyms for shift instructions:

- `MOV{S}{cond} Rd, Rm, ASR Rs` is a synonym for `ASR{S}{cond} Rd, Rm, Rs`
- `MOV{S}{cond} Rd, Rm, LSL Rs` is a synonym for `LSL{S}{cond} Rd, Rm, Rs`
- `MOV{S}{cond} Rd, Rm, LSR Rs` is a synonym for `LSR{S}{cond} Rd, Rm, Rs`
- `MOV{S}{cond} Rd, Rm, ROR Rs` is a synonym for `ROR{S}{cond} Rd, Rm, Rs`

See Section 3.5.3 (p. 60) .

The MVN instruction takes the value of *Operand2*, performs a bitwise logical NOT operation on the value, and places the result into *Rd*.

Note

The MOVW instruction provides the same function as MOV, but is restricted to using the *imm16* operand.

3.5.6.3 Restrictions

You can use SP and PC only in the MOV instruction, with the following restrictions:

- the second operand must be a register without shift
- you must not specify the S suffix.

When *Rd* is PC in a MOV instruction:

- bit[0] of the value written to the PC is ignored
- a branch occurs to the address created by forcing bit[0] of that value to 0.

Note

Though it is possible to use MOV as a branch instruction, ARM strongly recommends the use of a BX or BLX instruction to branch for software portability to the ARM instruction set.

3.5.6.4 Condition flags

If *S* is specified, these instructions:

- update the N and Z flags according to the result
- can update the C flag during the calculation of *Operand2*, see Section 3.3.3 (p. 38)
- do not affect the V flag.

3.5.6.5 Example

```

MOVS R11, #0x000B ; Write value of 0x000B to R11, flags get updated
MOV  R1, #0xFA05  ; Write value of 0xFA05 to R1, flags are not updated
MOVS R10, R12     ; Write value in R12 to R10, flags get updated
MOV  R3, #23      ; Write value of 23 to R3
MOV  R8, SP       ; Write value of stack pointer to R8
MVNS R2, #0xF     ; Write value of 0xFFFFFFFF0 (bitwise inverse of 0xF)
                    ; to the R2 and update flags

```

3.5.7 MOVT

Move Top.

3.5.7.1 Syntax

```
MOVT{cond} Rd, #imm16
```

where:

cond is an optional condition code, see Section 3.3.7 (p. 43) .

Rd is the destination register.

imm16 is a 16#bit immediate constant.

3.5.7.2 Operation

MOVT writes a 16#bit immediate value, *imm16*, to the top halfword, *Rd*[31:16], of its destination register. The write does not affect *Rd*[15:0].

The MOV, MOVT instruction pair enables you to generate any 32#bit constant.

3.5.7.3 Restrictions

Rd must not be SP and must not be PC.

3.5.7.4 Condition flags

This instruction does not change the flags.

3.5.7.5 Examples

```

MOVT  R3, #0xF123 ; Write 0xF123 to upper halfword of R3, lower halfword
                    ; and APSR are unchanged

```

3.5.8 REV, REV16, REVSH, and RBIT

Reverse bytes and Reverse bits.

3.5.8.1 Syntax

```
op{cond} Rd, Rn
```

where:

op is any of:

- REV Reverse byte order in a word.
- REV16 Reverse byte order in each halfword independently.
- REVSH Reverse byte order in the bottom halfword, and sign extend to 32 bits.
- RBIT Reverse the bit order in a 32#bit word.

cond is an optional condition code, see Section 3.3.7 (p. 43) .

Rd is the destination register.

Rn is the register holding the operand.

3.5.8.2 Operation

Use these instructions to change endianness of data:

- REV converts 32#bit big#endian data into little#endian data or 32#bit little#endian data into big#endian data.
- REV16 converts 16#bit big#endian data into little#endian data or 16#bit little#endian data into big#endian data.
- REVSH converts either:
 - 16#bit signed big#endian data into 32#bit signed little#endian data
 - 16#bit signed little#endian data into 32#bit signed big#endian data.

3.5.8.3 Restrictions

Do not use SP and do not use PC .

3.5.8.4 Condition flags

These instructions do not change the flags.

3.5.8.5 Examples

```
REV    R3, R7 ; Reverse byte order of value in R7 and write it to R3
REV16  R0, R0 ; Reverse byte order of each 16-bit halfword in R0
REVSH  R0, R5 ; Reverse Signed Halfword
REVSH  R3, R7 ; Reverse with Higher or Same condition
RBIT   R7, R8 ; Reverse bit order of value in R8 and write the result to R7
```

3.5.9 TST and TEQ

Test bits and Test Equivalence.

3.5.9.1 Syntax

TST{*cond*} *Rn*, *Operand2*

TEQ{*cond*} *Rn*, *Operand2*

where:

cond is an optional condition code, see Section 3.3.7 (p. 43) .

Rn is the register holding the first operand.

Operand2 is a flexible second operand. See Section 3.3.3 (p. 38) for details of the options.

3.5.9.2 Operation

These instructions test the value in a register against *Operand2*. They update the condition flags based on the result, but do not write the result to a register.

The `TST` instruction performs a bitwise AND operation on the value in *Rn* and the value of *Operand2*. This is the same as the `ANDS` instruction, except that it discards the result.

To test whether a bit of *Rn* is 0 or 1, use the `TST` instruction with an *Operand2* constant that has that bit set to 1 and all other bits cleared to 0.

The `TEQ` instruction performs a bitwise Exclusive OR operation on the value in *Rn* and the value of *Operand2*. This is the same as the `EORS` instruction, except that it discards the result.

Use the `TEQ` instruction to test if two values are equal without affecting the V or C flags.

`TEQ` is also useful for testing the sign of a value. After the comparison, the N flag is the logical Exclusive OR of the sign bits of the two operands.

3.5.9.3 Restrictions

Do not use SP and do not use PC.

3.5.9.4 Condition flags

These instructions:

- update the N and Z flags according to the result
- can update the C flag during the calculation of *Operand2*, see Section 3.3.3 (p. 38)
- do not affect the V flag.

3.5.9.5 Examples

```
TST    R0, #0x3F8 ; Perform bitwise AND of R0 value to 0x3F8,
                ; APSR is updated but result is discarded
TEQEQ  R10, R9   ; Conditionally test if value in R10 is equal to
                ; value in R9, APSR is updated but result is discarded
```

3.6 Multiply and divide instructions

Table 3.9 (p. 66) shows the multiply and divide instructions:

Table 3.9. Multiply and divide instructions

Mnemonic	Brief description	See
MLA	Multiply with Accumulate, 32-bit result	Section 3.6.1 (p. 67)
MLS	Multiply and Subtract, 32-bit result	Section 3.6.1 (p. 67)
MUL	Multiply, 32-bit result	Section 3.6.1 (p. 67)
SDIV	Signed Divide	Section 3.6.3 (p. 69)
SMLAL	Signed Multiply with Accumulate (32x32+64), 64-bit result	Section 3.6.2 (p. 68)
SMULL	Signed Multiply (32x32), 64-bit result	Section 3.6.2 (p. 68)
UDIV	Unsigned Divide	Section 3.6.3 (p. 69)
UMLAL	Unsigned Multiply with Accumulate (32x32+64), 64-bit result	Section 3.6.2 (p. 68)

Mnemonic	Brief description	See
UMULL	Unsigned Multiply (32x32), 64-bit result	Section 3.6.2 (p. 68)

3.6.1 MUL, MLA, and MLS

Multiply, Multiply with Accumulate, and Multiply with Subtract, using 32-bit operands, and producing a 32-bit result.

3.6.1.1 Syntax

`MUL{S}{cond} {Rd}, Rn, Rm ; Multiply`

`MLA{cond} Rd, Rn, Rm, Ra ; Multiply with accumulate`

`MLS{cond} Rd, Rn, Rm, Ra ; Multiply with subtract`

where:

cond is an optional condition code, see Section 3.3.7 (p. 43) .

S is an optional suffix. If *S* is specified, the condition code flags are updated on the result of the operation, see Section 3.3.7 (p. 43) .

Rd is the destination register. If *Rd* is omitted, the destination register is *Rn*.

Rn, *Rm* are registers holding the values to be multiplied.

Ra is a register holding the value to be added or subtracted from.

3.6.1.2 Operation

The `MUL` instruction multiplies the values from *Rn* and *Rm*, and places the least significant 32 bits of the result in *Rd*.

The `MLA` instruction multiplies the values from *Rn* and *Rm*, adds the value from *Ra*, and places the least significant 32 bits of the result in *Rd*.

The `MLS` instruction multiplies the values from *Rn* and *Rm*, subtracts the product from the value from *Ra*, and places the least significant 32 bits of the result in *Rd*.

The results of these instructions do not depend on whether the operands are signed or unsigned.

3.6.1.3 Restrictions

In these instructions, do not use SP and do not use PC.

If you use the S suffix with the `MUL` instruction:

- *Rd*, *Rn*, and *Rm* must all be in the range R0 to R7
- *Rd* must be the same as *Rm*
- you must not use the *cond* suffix.

3.6.1.4 Condition flags

If *S* is specified, the `MUL` instruction:

- updates the N and Z flags according to the result
- does not affect the C and V flags.

3.6.1.5 Examples

```

MUL    R10, R2, R5    ; Multiply, R10 = R2 x R5
MLA    R10, R2, R1, R5 ; Multiply with accumulate, R10 = (R2 x R1) + R5
MULS   R0, R2, R2     ; Multiply with flag update, R0 = R2 x R2
MULLT  R2, R3, R2     ; Conditionally multiply, R2 = R3 x R2
MLS    R4, R5, R6, R7 ; Multiply with subtract, R4 = R7 - (R5 x R6)

```

3.6.2 UMULL, UMLAL, SMULL, and SMLAL

Signed and Unsigned Long Multiply, with optional Accumulate, using 32#bit operands and producing a 64#bit result.

3.6.2.1 Syntax

op{*cond*} *RdLo*, *RdHi*, *Rn*, *Rm*

where:

op

is one of:

UMULL Unsigned Long Multiply.

UMLAL Unsigned Long Multiply, with Accumulate.

SMULL Signed Long Multiply.

SMLAL Signed Long Multiply, with Accumulate.

cond

is an optional condition code, see Section 3.3.7 (p. 43) .

RdHi, *RdLo*

are the destination registers. For UMLAL and SMLAL they also hold the accumulating value.

Rn, *Rm*

are registers holding the operands.

3.6.2.2 Operation

The UMULL instruction interprets the values from *Rn* and *Rm* as unsigned integers. It multiplies these integers and places the least significant 32 bits of the result in *RdLo*, and the most significant 32 bits of the result in *RdHi*.

The UMLAL instruction interprets the values from *Rn* and *Rm* as unsigned integers. It multiplies these integers, adds the 64#bit result to the 64#bit unsigned integer contained in *RdHi* and *RdLo*, and writes the result back to *RdHi* and *RdLo*.

The SMULL instruction interprets the values from *Rn* and *Rm* as two's complement signed integers. It multiplies these integers and places the least significant 32 bits of the result in *RdLo*, and the most significant 32 bits of the result in *RdHi*.

The SMLAL instruction interprets the values from *Rn* and *Rm* as two's complement signed integers. It multiplies these integers, adds the 64#bit result to the 64#bit signed integer contained in *RdHi* and *RdLo*, and writes the result back to *RdHi* and *RdLo*.

3.6.2.3 Restrictions

In these instructions:

- do not use SP and do not use PC
- *RdHi* and *RdLo* must be different registers.

3.6.2.4 Condition flags

These instructions do not affect the condition code flags.

3.6.2.5 Examples

```
UMULL    R0, R4, R5, R6 ; Unsigned (R4,R0) = R5 x R6
SMLAL   R4, R5, R3, R8 ; Signed (R5,R4) = (R5,R4) + R3 x R8
```

3.6.3 SDIV and UDIV

Signed Divide and Unsigned Divide.

3.6.3.1 Syntax

```
SDIV{cond} {Rd,} Rn, Rm
```

```
UDIV{cond} {Rd,} Rn, Rm
```

where:

cond is an optional condition code, see Section 3.3.7 (p. 43) .
Rd is the destination register. If *Rd* is omitted, the destination register is *Rn*.
Rn is the register holding the value to be divided.
Rm is a register holding the divisor.

3.6.3.2 Operation

SDIV performs a signed integer division of the value in *Rn* by the value in *Rm*.

UDIV performs an unsigned integer division of the value in *Rn* by the value in *Rm*.

For both instructions, if the value in *Rn* is not divisible by the value in *Rm*, the result is rounded towards zero.

3.6.3.3 Restrictions

Do not use SP and do not use PC.

3.6.3.4 Condition flags

These instructions do not change the flags.

3.6.3.5 Examples

```
SDIV R0, R2, R4 ; Signed divide, R0 = R2/R4
UDIV R8, R8, R1 ; Unsigned divide, R8 = R8/R1
```

3.7 Saturating instructions

This section describes the saturating instructions, SSAT and USAT.

3.7.1 SSAT and USAT

Signed Saturate and Unsigned Saturate to any bit position, with optional shift before saturating.

3.7.1.1 Syntax

```
op{cond} Rd, #n, Rm {, shift #s}
```

where:

<i>op</i>	is one of: SSAT Saturates a signed value to a signed range. USAT Saturates a signed value to an unsigned range.
<i>cond</i>	is an optional condition code, see Section 3.3.7 (p. 43) .
<i>Rd</i>	is the destination register.
<i>n</i>	specifies the bit position to saturate to: • <i>n</i> ranges from 1 to 32 for SSAT • <i>n</i> ranges from 0 to 31 for USAT.
<i>Rm</i>	is the register containing the value to saturate.
<i>shift#s</i>	is an optional shift applied to <i>Rm</i> before saturating. It must be one of the following: ASR # <i>s</i> where <i>s</i> is in the range 1 to 31 LSL # <i>s</i> where <i>s</i> is in the range 0 to 31.

3.7.1.2 Operation

These instructions saturate to a signed or unsigned *n*-bit value.

The SSAT instruction applies the specified shift, then saturates to the signed range $\#2^{n-1} \#x \#2^{n-1}\#1$.

The USAT instruction applies the specified shift, then saturates to the unsigned range $0 \#x \#2^n\#1$.

For signed *n*-bit saturation using SSAT, this means that:

- if the value to be saturated is less than $\#2^{n-1}$, the result returned is $\#2^{n-1}$
- if the value to be saturated is greater than $2^{n-1}\#1$, the result returned is $2^{n-1}\#1$
- otherwise, the result returned is the same as the value to be saturated.

For unsigned *n*-bit saturation using USAT, this means that:

- if the value to be saturated is less than 0, the result returned is 0
- if the value to be saturated is greater than $2^n\#1$, the result returned is $2^n\#1$
- otherwise, the result returned is the same as the value to be saturated.

If the returned result is different from the value to be saturated, it is called *saturation*. If saturation occurs, the instruction sets the Q flag to 1 in the APSR. Otherwise, it leaves the Q flag unchanged. To clear the Q flag to 0, you must use the MSR instruction, see Section 3.10.7 (p. 83) .

To read the state of the Q flag, use the MRS instruction, see Section 3.10.6 (p. 83) .

3.7.1.3 Restrictions

Do not use SP and do not use PC.

3.7.1.4 Condition flags

These instructions do not affect the condition code flags.

If saturation occurs, these instructions set the Q flag to 1.

3.7.1.5 Examples

```
SSAT R7, #16, R7, LSL #4 ; Logical shift left value in R7 by 4, then
```

```

USATNE R0, #7, R5
; saturate it as a signed 16-bit value and
; write it back to R7
; Conditionally saturate value in R5 as an
; unsigned 7 bit value and write it to R0

```

3.8 Bitfield instructions

Table 3.10 (p. 71) shows the instructions that operate on adjacent sets of bits in registers or bitfields:

Table 3.10. Packing and unpacking instructions

Mnemonic	Brief description	See
BFC	Bit Field Clear	Section 3.8.1 (p. 71)
BFI	Bit Field Insert	Section 3.8.1 (p. 71)
SBFX	Signed Bit Field Extract	Section 3.8.2 (p. 72)
SXTB	Sign extend a byte	Section 3.8.3 (p. 72)
SXTH	Sign extend a halfword	Section 3.8.3 (p. 72)
UBFX	Unsigned Bit Field Extract	Section 3.8.2 (p. 72)
UXTB	Zero extend a byte	Section 3.8.3 (p. 72)
UXTH	Zero extend a halfword	Section 3.8.3 (p. 72)

3.8.1 BFC and BFI

Bit Field Clear and Bit Field Insert.

3.8.1.1 Syntax

```
BFC{cond} Rd, #lsb, #width
```

```
BFI{cond} Rd, Rn, #lsb, #width
```

where:

cond is an optional condition code, see Section 3.3.7 (p. 43) .

Rd is the destination register.

Rn is the source register.

lsb is the position of the least significant bit of the bitfield. *lsb* must be in the range 0 to 31.

width is the width of the bitfield and must be in the range 1 to 32-*lsb*.

3.8.1.2 Operation

BFC clears a bitfield in a register. It clears *width* bits in *Rd*, starting at the low bit position *lsb*. Other bits in *Rd* are unchanged.

BFI copies a bitfield into one register from another register. It replaces *width* bits in *Rd* starting at the low bit position *lsb*, with *width* bits from *Rn* starting at bit[0]. Other bits in *Rd* are unchanged.

3.8.1.3 Restrictions

Do not use SP and do not use PC.

3.8.1.4 Condition flags

These instructions do not affect the flags.

3.8.1.5 Examples

```
BFC  R4, #8, #12      ; Clear bit 8 to bit 19 (12 bits) of R4 to 0
BFI  R9, R2, #8, #12 ; Replace bit 8 to bit 19 (12 bits) of R9 with
                        ; bit 0 to bit 11 from R2
```

3.8.2 SBFX and UBFX

Signed Bit Field Extract and Unsigned Bit Field Extract.

3.8.2.1 Syntax

```
SBFX{cond} Rd, Rn, #lsb, #width
```

```
UBFX{cond} Rd, Rn, #lsb, #width
```

where:

cond is an optional condition code, see Section 3.3.7 (p. 43) .

Rd is the destination register.

Rn is the source register.

lsb is the position of the least significant bit of the bitfield. *lsb* must be in the range 0 to 31.

width is the width of the bitfield and must be in the range 1 to 32-*lsb*.

3.8.2.2 Operation

SBFX extracts a bitfield from one register, sign extends it to 32 bits, and writes the result to the destination register.

UBFX extracts a bitfield from one register, zero extends it to 32 bits, and writes the result to the destination register.

3.8.2.3 Restrictions

Do not use SP and do not use PC .

3.8.2.4 Condition flags

These instructions do not affect the flags.

3.8.2.5 Examples

```
SBFX R0, R1, #20, #4 ; Extract bit 20 to bit 23 (4 bits) from R1 and sign
                        ; extend to 32 bits and then write the result to R0.
UBFX R8, R11, #9, #10 ; Extract bit 9 to bit 18 (10 bits) from R11 and zero
                        ; extend to 32 bits and then write the result to R8
```

3.8.3 SXT and UXT

Sign extend and Zero extend.

3.8.3.1 Syntax

```
SXTextend{cond} {Rd,} Rm {, ROR #n}
```



```
UXTextend{cond} {Rd}, Rm {, ROR #n}
```

where:

extend is one of:

- B Extends an 8#bit value to a 32#bit value.
- H Extends a 16#bit value to a 32#bit value.

cond is an optional condition code, see Section 3.3.7 (p. 43) .

Rd is the destination register.

Rm is the register holding the value to extend.

ROR #n is one of:

- ROR #8 Value from *Rm* is rotated right 8 bits.
- ROR #16 Value from *Rm* is rotated right 16 bits.
- ROR #24 Value from *Rm* is rotated right 24 bits.

If *ROR #n* is omitted, no rotation is performed.

3.8.3.2 Operation

These instructions do the following:

1. Rotate the value from *Rm* right by 0, 8, 16 or 24 bits.
2. Extract bits from the resulting value:
 - SXTB extracts bits[7:0] and sign extends to 32 bits.
 - UXTB extracts bits[7:0] and zero extends to 32 bits.
 - SXTH extracts bits[15:0] and sign extends to 32 bits.
 - UXTH extracts bits[15:0] and zero extends to 32 bits.

3.8.3.3 Restrictions

Do not use SP and do not use PC.

3.8.3.4 Condition flags

These instructions do not affect the flags.

3.8.3.5 Examples

```
SXTH R4, R6, ROR #16 ; Rotate R6 right by 16 bits, then obtain the lower
                    ; halfword of the result and then sign extend to
                    ; 32 bits and write the result to R4.
UXTB R3, R10        ; Extract lowest byte of the value in R10 and zero
                    ; extend it, and write the result to R3
```

3.9 Branch and control instructions

Table 3.11 (p. 73) shows the branch and control instructions:

Table 3.11. Branch and control instructions

Mnemonic	Brief description	See
B	Branch	Section 3.9.1 (p. 74)
BL	Branch with Link	Section 3.9.1 (p. 74)
BLX	Branch indirect with Link	Section 3.9.1 (p. 74)

Mnemonic	Brief description	See
BX	Branch indirect	Section 3.9.1 (p. 74)
CBNZ	Compare and Branch if Non Zero	Section 3.9.2 (p. 75)
CBZ	Compare and Branch if Non Zero	Section 3.9.2 (p. 75)
IT	If#Then	Section 3.9.3 (p. 76)
TBB	Table Branch Byte	Section 3.9.4 (p. 78)
TBH	Table Branch Halfword	Section 3.9.4 (p. 78)

3.9.1 B, BL, BX, and BLX

Branch instructions.

3.9.1.1 Syntax

$B\{cond\} \text{ label}$

$BL\{cond\} \text{ label}$

$BX\{cond\} Rm$

$BLX\{cond\} Rm$

where:

B is branch (immediate).

BL is branch with link (immediate).

BX is branch indirect (register).

BLX is branch indirect with link (register).

$cond$ is an optional condition code, see Section 3.3.7 (p. 43) .

$label$ is a PC#relative expression. See Section 3.3.6 (p. 42) .

Rm is a register that indicates an address to branch to. Bit[0] of the value in Rm must be 1, but the address to branch to is created by changing bit[0] to 0.

3.9.1.2 Operation

All these instructions cause a branch to $label$, or to the address indicated in Rm . In addition:

- The BL and BLX instructions write the address of the next instruction to LR (the link register, R14).
- The BX and BLX instructions cause a UsageFault exception if bit[0] of Rm is 0.

$Bcond \text{ label}$ is the only conditional instruction that can be either inside or outside an IT block. All other branch instructions must be conditional inside an IT block, and must be unconditional outside the IT block, see Section 3.9.3 (p. 76) .

Table 3.12 (p. 74) shows the ranges for the various branch instructions.

Table 3.12. Branch ranges

Instruction	Branch range
$B \text{ label}$	#16 MB to +16 MB
$Bcond \text{ label}$ (outside IT block)	#1 MB to +1 MB

Instruction	Branch range
<i>Bcond</i> label (inside IT block)	#16 MB to +16 MB
BL{ <i>cond</i> } label	#16 MB to +16 MB
BX{ <i>cond</i> } Rm	Any value in register
BLX{ <i>cond</i> } Rm	Any value in register

Note

You might have to use the *.W* suffix to get the maximum branch range. See Section 3.3.8 (p. 45) .

3.9.1.3 Restrictions

The restrictions are:

- do not use PC in the BLX instruction
- for BX and BLX, bit[0] of *Rm* must be 1 for correct execution but a branch occurs to the target address created by changing bit[0] to 0
- when any of these instructions is inside an IT block, it must be the last instruction of the IT block.

Note

Bcond is the only conditional instruction that is not required to be inside an IT block. However, it has a longer branch range when it is inside an IT block.

3.9.1.4 Condition flags

These instructions do not change the flags.

3.9.1.5 Examples

```

B      loopA ; Branch to loopA
BLE   ng    ; Conditionally branch to label ng
B.W   target ; Branch to target within 16MB range
BEQ   target ; Conditionally branch to target
BEQ.W target ; Conditionally branch to target within 1MB
BL    funC  ; Branch with link (Call) to function funC, return address
        ; stored in LR
BX    LR    ; Return from function call
BXNE  R0    ; Conditionally branch to address stored in R0
BLX   R0    ; Branch with link and exchange (Call) to a address stored
        ; in R0

```

3.9.2 CBZ and CBNZ

Compare and Branch on Zero, Compare and Branch on Non#Zero.

3.9.2.1 Syntax

```
CBZ Rn, label
```

```
CBNZ Rn, label
```

where:

Rn is the register holding the operand.

label is the branch destination.

3.9.2.2 Operation

Use the CBZ or CBNZ instructions to avoid changing the condition code flags and to reduce the number of instructions.

CBZ *Rn*, *label* does not change condition flags but is otherwise equivalent to:

```
CMP    Rn, #0
BEQ    label
```

CBNZ *Rn*, *label* does not change condition flags but is otherwise equivalent to:

```
CMP    Rn, #0
BNE    label
```

3.9.2.3 Restrictions

The restrictions are:

- *Rn* must be in the range of R0 to R7
- the branch destination must be within 4 to 130 bytes after the instruction
- these instructions must not be used inside an IT block.

3.9.2.4 Condition flags

These instructions do not change the flags.

3.9.2.5 Examples

```
CBZ    R5, target ; Forward branch if R5 is zero
CBNZ   R0, target ; Forward branch if R0 is not zero
```

3.9.3 IT

If-Then condition instruction.

3.9.3.1 Syntax

```
IT{x{y{z}}} cond
```

where:

- x* specifies the condition switch for the second instruction in the IT block.
- y* specifies the condition switch for the third instruction in the IT block.
- z* specifies the condition switch for the fourth instruction in the IT block.
- cond* specifies the condition for the first instruction in the IT block.

The condition switch for the second, third and fourth instruction in the IT block can be either:

- T Then. Applies the condition *cond* to the instruction.
- E Else. Applies the inverse condition of *cond* to the instruction.

Note

It is possible to use AL (the *a*lways condition) for *cond* in an IT instruction. If this is done, all of the instructions in the IT block must be unconditional, and each of *x*, *y*, and *z* must be T or omitted but not E.

3.9.3.2 Operation

The `IT` instruction makes up to four following instructions conditional. The conditions can be all the same, or some of them can be the logical inverse of the others. The conditional instructions following the `IT` instruction form the *IT block*.

The instructions in the IT block, including any branches, must specify the condition in the `{cond}` part of their syntax.

Note

Your assembler might be able to generate the required `IT` instructions for conditional instructions automatically, so that you do not need to write them yourself. See your assembler documentation for details.

A `BKPT` instruction in an IT block is always executed, even if its condition fails.

Exceptions can be taken between an `IT` instruction and the corresponding IT block, or within an IT block. Such an exception results in entry to the appropriate exception handler, with suitable return information in LR and stacked PSR.

Instructions designed for use for exception returns can be used as normal to return from the exception, and execution of the IT block resumes correctly. This is the only way that a `PC#`-modifying instruction is permitted to branch to an instruction in an IT block.

3.9.3.3 Restrictions

The following instructions are not permitted in an IT block:

- `IT`
- `CBZ` and `CBNZ`
- `CPSID` and `CPSIE`.

Other restrictions when using an IT block are:

- a branch or any instruction that modifies the PC must either be outside an IT block or must be the last instruction inside the IT block. These are:
 - `ADD PC, PC, Rm`
 - `MOV PC, Rm`
 - `B`, `BL`, `BX`, `BLX`
 - any `LDM`, `LDR`, or `POP` instruction that writes to the PC
 - `TBB` and `TBH`
- do not branch to any instruction inside an IT block, except when returning from an exception handler
- all conditional instructions except `Bcond` must be inside an IT block. `Bcond` can be either outside or inside an IT block but has a larger branch range if it is inside one
- each instruction inside the IT block must specify a condition code suffix that is either the same or logical inverse as for the other instructions in the block.

Note

Your assembler might place extra restrictions on the use of IT blocks, such as prohibiting the use of assembler directives within them.

3.9.3.4 Condition flags

This instruction does not change the flags.

3.9.3.5 Example

```

ITTE  NE          ; Next 3 instructions are conditional
ANDNE R0, R0, R1  ; ANDNE does not update condition flags
ADDSNE R2, R2, #1 ; ADDSNE updates condition flags
MOVEQ R2, R3      ; Conditional move

CMP    R0, #9      ; Convert R0 hex value (0 to 15) into ASCII
                ; ('0'-'9', 'A'-'F')
ITE    GT          ; Next 2 instructions are conditional
ADDGT  R1, R0, #55 ; Convert 0xA -> 'A'
ADDLE  R1, R0, #48 ; Convert 0x0 -> '0'

IT     GT          ; IT block with only one conditional instruction
                ADDGT  R1, R1, #1 ; In

ITTEE  EQ          ; Next 4 instructions are conditional
MOVEQ  R0, R1      ; Conditional move
ADDEQ  R2, R2, #10 ; Conditional add
ANDNE  R3, R3, #1  ; Conditional AND
BNE.W  dloop       ; Branch instruction can only be used in the last
                ; instruction of an IT block

IT     NE          ; Next instruction is conditional
ADD    R0, R0, R1  ; Syntax error: no condition code used in IT block

```

3.9.4 TBB and TBH

Table Branch Byte and Table Branch Halfword.

3.9.4.1 Syntax

```
TBB [Rn, Rm]
```

```
TBH [Rn, Rm, LSL #1]
```

where:

Rn is the register containing the address of the table of branch lengths.

If *Rn* is PC, then the address of the table is the address of the byte immediately following the TBB or TBH instruction.

Rm is the index register. This contains an index into the table. For halfword tables, LSL #1 doubles the value in *Rm* to form the right offset into the table.

3.9.4.2 Operation

These instructions cause a PC#relative forward branch using a table of single byte offsets for TBB, or halfword offsets for TBH. *Rn* provides a pointer to the table, and *Rm* supplies an index into the table. For TBB the branch offset is twice the unsigned value of the byte returned from the table. and for TBH the branch offset is twice the unsigned value of the halfword returned from the table. The branch occurs to the address at that offset from the address of the byte immediately after the TBB or TBH instruction.

3.9.4.3 Restrictions

The restrictions are:

- *Rn* must not be SP

- *Rm* must not be SP and must not be PC
- when any of these instructions is used inside an IT block, it must be the last instruction of the IT block.

3.9.4.4 Condition flags

These instructions do not change the flags.

3.9.4.5 Examples

```

ADR.W R0, BranchTable_Byte
TBB [R0, R1] ; R1 is the index, R0 is the base address of the
; branch table

Case1
; an instruction sequence follows
Case2
; an instruction sequence follows
Case3
; an instruction sequence follows
BranchTable_Byte
DCB 0 ; Case1 offset calculation
DCB ((Case2-Case1)/2) ; Case2 offset calculation
DCB ((Case3-Case1)/2) ; Case3 offset calculation

TBH [PC, R1, LSL #1] ; R1 is the index, PC is used as base of the
; branch table

BranchTable_H
DCI ((CaseA - BranchTable_H)/2) ; CaseA offset calculation
DCI ((CaseB - BranchTable_H)/2) ; CaseB offset calculation
DCI ((CaseC - BranchTable_H)/2) ; CaseC offset calculation

CaseA
; an instruction sequence follows
CaseB
; an instruction sequence follows
CaseC
; an instruction sequence follows

```

3.10 Miscellaneous instructions

Table 3.13 (p. 79) shows the remaining Cortex-M3 instructions:

Table 3.13. Miscellaneous instructions

Mnemonic	Brief description	See
BKPT	Breakpoint	Section 3.10.1 (p. 80)
CPSID	Change Processor State, Disable Interrupts	Section 3.10.2 (p. 80)
CPSIE	Change Processor State, Enable Interrupts	Section 3.10.2 (p. 80)
DMB	Data Memory Barrier	Section 3.10.3 (p. 81)
DSB	Data Synchronization Barrier	Section 3.10.4 (p. 82)
ISB	Instruction Synchronization Barrier	Section 3.10.5 (p. 82)

Mnemonic	Brief description	See
MRS	Move from special register to register	Section 3.10.6 (p. 83)
MSR	Move from register to special register	Section 3.10.7 (p. 83)
NOP	No Operation	Section 3.10.8 (p. 84)
SEV	Send Event	Section 3.10.9 (p. 85)
SVC	Supervisor Call	Section 3.10.10 (p. 85)
WFE	Wait For Event	Section 3.10.11 (p. 86)
WFI	Wait For Interrupt	Section 3.10.12 (p. 86)

3.10.1 BKPT

Breakpoint.

3.10.1.1 Syntax

```
BKPT #imm
```

where:

imm is an expression evaluating to an integer in the range 0-255 (8-bit value).

3.10.1.2 Operation

The BKPT instruction causes the processor to enter Debug state. Debug tools can use this to investigate system state when the instruction at a particular address is reached.

imm is ignored by the processor. If required, a debugger can use it to store additional information about the breakpoint.

The BKPT instruction can be placed inside an IT block, but it executes unconditionally, unaffected by the condition specified by the IT instruction.

3.10.1.3 Condition flags

This instruction does not change the flags.

3.10.1.4 Examples

```
BKPT 0xAB ; Breakpoint with immediate value set to 0xAB (debugger can
           ; extract the immediate value by locating it using the PC)
```

3.10.2 CPS

Change Processor State.

3.10.2.1 Syntax

CPSeffect iflags

where:

effect is one of:

IE Clears the special purpose register.

ID Sets the special purpose register.

iflags is a sequence of one or more flags:

i Set or clear PRIMASK.

f Set or clear FAULTMASK.

3.10.2.2 Operation

CPS changes the PRIMASK and FAULTMASK special register values. See Section 2.1.3.6 (p. 11) for more information about these registers.

3.10.2.3 Restrictions

The restrictions are:

- use CPS only from privileged software, it has no effect if used in unprivileged software
- CPS cannot be conditional and so must not be used inside an IT block.

3.10.2.4 Condition flags

This instruction does not change the condition flags.

3.10.2.5 Examples

```
CPSID i ; Disable interrupts and configurable fault handlers (set PRIMASK)
CPSID f ; Disable interrupts and all fault handlers (set FAULTMASK)
CPSIE i ; Enable interrupts and configurable fault handlers (clear PRIMASK)
CPSIE f ; Enable interrupts and fault handlers (clear FAULTMASK)
```

3.10.3 DMB

Data Memory Barrier.

3.10.3.1 Syntax

DMB{*cond*}

where:

cond is an optional condition code, see Section 3.3.7 (p. 43) .

3.10.3.2 Operation

DMB acts as a data memory barrier. It ensures that all explicit memory accesses that appear, in program order, before the DMB instruction are completed before any explicit memory accesses that appear, in program order, after the DMB instruction. DMB does not affect the ordering or execution of instructions that do not access memory.

3.10.3.3 Condition flags

This instruction does not change the flags.

3.10.3.4 Examples

DMB ; Data Memory Barrier

3.10.4 DSB

Data Synchronization Barrier.

3.10.4.1 Syntax

DSB{*cond*}

where:

cond is an optional condition code, see Section 3.3.7 (p. 43) .

3.10.4.2 Operation

DSB acts as a special data synchronization memory barrier. Instructions that come after the DSB, in program order, do not execute until the DSB instruction completes. The DSB instruction completes when all explicit memory accesses before it complete.

3.10.4.3 Condition flags

This instruction does not change the flags.

3.10.4.4 Examples

DSB ; Data Synchronisation Barrier

3.10.5 ISB

Instruction Synchronization Barrier.

3.10.5.1 Syntax

ISB{*cond*}

where:

cond is an optional condition code, see Section 3.3.7 (p. 43) .

3.10.5.2 Operation

ISB acts as an instruction synchronization barrier. It flushes the pipeline of the processor, so that all instructions following the ISB are fetched from cache or memory again, after the ISB instruction has been completed.

3.10.5.3 Condition flags

This instruction does not change the flags.

3.10.5.4 Examples

3.10.6 MRS

Move the contents of a special register to a general#purpose register.

3.10.6.1 Syntax

```
MRS{cond} Rd, spec_reg
```

where:

cond is an optional condition code, see Section 3.3.7 (p. 43) .

Rd is the destination register.

spec_reg can be any of: APSR, IPSR, EPSR, IEPSR, IAPSR, EAPSR, PSR, MSP, PSP, PRIMASK, BASEPRI, BASEPRI_MAX, FAULTMASK, or CONTROL.

3.10.6.2 Operation

Use MRS in combination with MSR as part of a read#modify#write sequence for updating a PSR, for example to clear the Q flag.

In process swap code, the programmers model state of the process being swapped out must be saved, including relevant PSR contents. Similarly, the state of the process being swapped in must also be restored. These operations use MRS in the state-saving instruction sequence and MSR in the state-restoring instruction sequence.

Note

BASEPRI_MAX is an alias of BASEPRI when used with the MRS instruction.

See Section 3.10.7 (p. 83) .

3.10.6.3 Restrictions

Rd must not be SP and must not be PC.

3.10.6.4 Condition flags

This instruction does not change the flags.

3.10.6.5 Examples

```
MRS R0, PRIMASK ; Read PRIMASK value and write it to R0
```

3.10.7 MSR

Move the contents of a general#purpose register into the specified special register.

3.10.7.1 Syntax

```
MSR{cond} spec_reg, Rn
```

where:

cond is an optional condition code, see Section 3.3.7 (p. 43) .

Rn is the source register.

spec_reg can be any of: APSR, IPSR, EPSR, IEPSR, IAPSR, EAPSR, PSR, MSP, PSP, PRIMASK, BASEPRI, BASEPRI_MAX, FAULTMASK, or CONTROL.

3.10.7.2 Operation

The register access operation in MSR depends on the privilege level. Unprivileged software can only access the APSR, see Table 2.4 (p. 9) . Privileged software can access all special registers.

In unprivileged software writes to unallocated or execution state bits in the PSR are ignored.

Note

When you write to BASEPRI_MAX, the instruction writes to BASEPRI only if either:

- *Rn* is non-zero and the current BASEPRI value is 0
- *Rn* is non-zero and less than the current BASEPRI value.

See Section 3.10.6 (p. 83) .

3.10.7.3 Restrictions

Rn must not be SP and must not be PC.

3.10.7.4 Condition flags

This instruction updates the flags explicitly based on the value in *Rn*.

3.10.7.5 Examples

```
MSR CONTROL, R1 ; Read R1 value and write it to the CONTROL register
```

3.10.8 NOP

No Operation.

3.10.8.1 Syntax

```
NOP{cond}
```

where:

cond is an optional condition code, see Section 3.3.7 (p. 43) .

3.10.8.2 Operation

NOP does nothing. NOP is not necessarily a time-consuming NOP. The processor might remove it from the pipeline before it reaches the execution stage.

Use NOP for padding, for example to place the following instruction on a 64#bit boundary.

3.10.8.3 Condition flags

This instruction does not change the flags.

3.10.8.4 Examples

NOP ; No operation

3.10.9 SEV

Send Event.

3.10.9.1 Syntax

SEV{*cond*}

where:

cond is an optional condition code, see Section 3.3.7 (p. 43) .

3.10.9.2 Operation

SEV is a hint instruction that causes an event to be signaled to all processors within a multiprocessor system. It also sets the local event register to 1, see Section 2.5 (p. 30) .

3.10.9.3 Condition flags

This instruction does not change the flags.

3.10.9.4 Examples

SEV ; Send Event

3.10.10 SVC

Supervisor Call.

3.10.10.1 Syntax

SVC{*cond*} #*imm*

where:

cond is an optional condition code, see Section 3.3.7 (p. 43) .

imm is an expression evaluating to an integer in the range 0#255 (8#bit value).

3.10.10.2 Operation

The *SVC* instruction causes the *SVC* exception.

imm is ignored by the processor. If required, it can be retrieved by the exception handler to determine what service is being requested.

3.10.10.3 Condition flags

This instruction does not change the flags.

3.10.10.4 Examples

SVC 0x32 ; Supervisor Call (SVC handler can extract the immediate value

; by locating it via the stacked PC)

3.10.11 WFE

Wait For Event.

3.10.11.1 Syntax

WFE{*cond*}

where:

cond is an optional condition code, see Section 3.3.7 (p. 43) .

3.10.11.2 Operation

WFE is a hint instruction.

If the event register is 0, WFE suspends execution until one of the following events occurs:

- an exception, unless masked by the exception mask registers or the current priority level
- an exception enters the Pending state, if SEVONPEND in the System Control Register is set
- a Debug Entry request, if Debug is enabled
- an event signaled by a peripheral or another processor in a multiprocessor system using the SEV instruction.

If the event register is 1, WFE clears it to 0 and returns immediately.

For more information see Section 2.5 (p. 30) .

3.10.11.3 Condition flags

This instruction does not change the flags.

3.10.11.4 Examples

```
WFE ; Wait for event
```

3.10.12 WFI

Wait for Interrupt.

3.10.12.1 Syntax

WFI{*cond*}

where:

cond is an optional condition code, see Section 3.3.7 (p. 43) .

3.10.12.2 Operation

WFI is a hint instruction that suspends execution until one of the following events occurs:

- an exception

- a Debug Entry request, regardless of whether Debug is enabled.

3.10.12.3 Condition flags

This instruction does not change the flags.

3.10.12.4 Examples

```
WFI ; Wait for interrupt
```

4 The Cortex-M3 Peripherals

4.1 About the peripherals

The address map of the *Private peripheral bus* (PPB) is:

Table 4.1. Core peripheral register regions

Address	Core peripheral	Description
0xE000E008-0xE000E00F	System control block	Table 4.12 (p. 94)
0xE000E010-0xE000E01F	System timer	Table 4.32 (p. 111)
0xE000E100-0xE000E4EF	Nested Vectored Interrupt Controller	Table 4.2 (p. 88)
0xE000ED00-0xE000ED3F	System control block	Table 4.12 (p. 94)
0xE000ED90-0xE000EDB8	Memory protection unit	Section 4.5.1 (p. 114) ¹
0xE000EF00-0xE000EF03	Nested Vectored Interrupt Controller	Table 4.2 (p. 88)

¹Software can read the MPU Type Register at 0xE000ED90 to test for the presence of a *memory protection unit* (MPU). Register will read as zero if MPU is not present.

In register descriptions:

- the register *type* is described as follows:
 - RW Read and write.
 - RO Read-only.
 - WO Write-only.
- the *required privilege* gives the privilege level required to access the register, as follows:
 - Privileged Only privileged software can access the register.
 - Unprivileged Both unprivileged and privileged software can access the register.

4.2 Nested Vectored Interrupt Controller

This section describes the Nested Vectored Interrupt Controller (NVIC) and the registers it uses. The NVIC supports:

- The number of interrupts given by Table 1.1 (p. 5) .
- A programmable priority level of 0-7 for each interrupt. A higher level corresponds to a lower priority, so level 0 is the highest interrupt priority.
- Level detection of interrupt signals.
- Dynamic reprioritization of interrupts.
- Grouping of priority values into group priority and subpriority fields.
- Interrupt tail-chaining.

The processor automatically stacks its state on exception entry and unstacks this state on exception exit, with no instruction overhead. This provides low latency exception handling. The hardware implementation of the NVIC registers is:

Table 4.2. NVIC register summary

Address	Name	Type	Required privilege	Reset value	Description
0xE000E100-0xE000E104	ISER0- ISER1	RW	Privileged	0x00000000	Section 4.2.2 (p. 89)
0xE000E180-0xE000E184	ICER0- ICER1	RW	Privileged	0x00000000	Section 4.2.3 (p. 90)

Address	Name	Type	Required privilege	Reset value	Description
0xE000E200-0xE000E204	ISPR0-ISPR1	RW	Privileged	0x00000000	Section 4.2.4 (p. 90)
0xE000E280-0xE000E284	ICPR0-ICPR1	RW	Privileged	0x00000000	Section 4.2.5 (p. 91)
0xE000E300-0xE000E304	IABR0-IABR1	RO	Privileged	0x00000000	Section 4.2.6 (p. 91)
0xE000E400-0xE000E400+4xm	IPR0-IPRm	RW	Privileged	0x00000000	Section 4.2.7 (p. 92) ¹
0xE000EF00	STIR	WO	Configurable ²	0x00000000	Section 4.2.8 (p. 93)

¹m=(n-1)/4, where n denotes the number of interrupts given in Table 1.1 (p. 5) .

²See the register description for more information.

4.2.1 The CMSIS mapping of the Cortex-M3 NVIC registers

To improve software efficiency, the CMSIS simplifies the NVIC register presentation. In the CMSIS:

- the Set-enable, Clear-enable, Set-pending, Clear-pending and Active Bit registers map to arrays of 32-bit integers, so that:
 - ISER[0] to ISER[1] corresponds to the registers ISER0-ISER1
 - ICER[0] to ICER[1] corresponds to the registers ICER0-ICER1
 - ISPR[0] to ISPR[1] corresponds to the registers ISPR0-ISPR1
 - ICPR[0] to ICPR[1] corresponds to the registers ICPR0-ICPR1
 - IABR[0] to IABR[1] corresponds to the registers IABR0-IABR1
- the 8-bit fields of the Interrupt Priority Registers map to an array of 8-bit integers, so that the array IP[0] to IP[n-1] corresponds to the registers IPR0-IPRm (m=(n-1)/4, where n denotes the number of interrupts given by Table 1.1 (p. 5)), and the array entry IP[N] holds the interrupt priority for interrupt N.

The CMSIS provides thread-safe code that gives atomic access to the Interrupt Priority Registers. For more information see the description of the NVIC_SetPriority function in Section 4.2.10.1 (p. 94) . Table 4.3 (p. 89) shows how the interrupts, or IRQ numbers, map onto the interrupt registers and corresponding CMSIS variables that have one bit per interrupt.

Table 4.3. Mapping of interrupts to the interrupt variables

Interrupts	CMSIS array elements ¹				
	Set-enable	Clear-enable	Set-pending	Clear-pending	Active Bit
0-31	ISER[0]	ICER[0]	ISPR[0]	ICPR[0]	IABR[0]
32-63	ISER[1]	ICER[1]	ISPR[1]	ICPR[1]	IABR[1]

¹Each array element corresponds to a single NVIC register, for example the element ICER[1] corresponds to the ICER1 register.

4.2.2 Interrupt Set-enable Registers

The ISER0 and ISER1 registers enable interrupts, and show which interrupts are enabled. See:

- the register summary in Table 4.2 (p. 88) for the register attributes
- Table 4.3 (p. 89) for which interrupts are controlled by each register.

The bit assignments are:

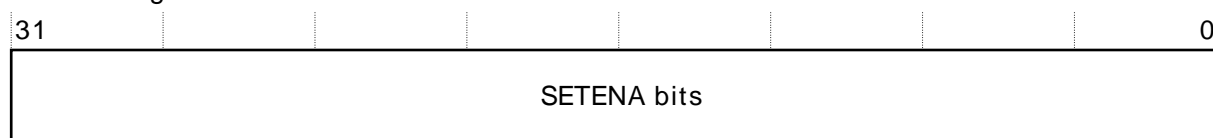

Table 4.4. ISER bit assignments

Bits	Name	Function
[31:0]	SETENA	Interrupt set-enable bits. Write: 0 = no effect 1 = enable interrupt. Read: 0 = interrupt disabled 1 = interrupt enabled.

If a pending interrupt is enabled, the NVIC activates the interrupt based on its priority. If an interrupt is not enabled, asserting its interrupt signal changes the interrupt state to pending, but the NVIC never activates the interrupt, regardless of its priority.

4.2.3 Interrupt Clear-enable Registers

The ICER0 and ICER1 registers disable interrupts, and show which interrupts are enabled. See:

- the register summary in Table 4.2 (p. 88) for the register attributes
- Table 4.3 (p. 89) for which interrupts are controlled by each register.

The bit assignments are:

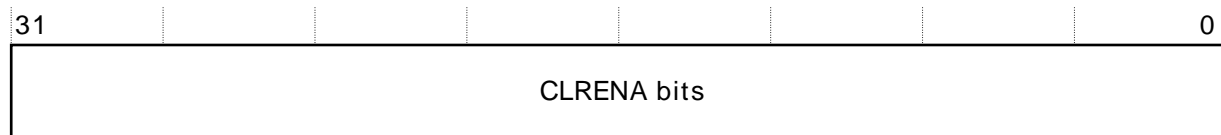

Table 4.5. ICER bit assignments

Bits	Name	Function
[31:0]	CLRENA	Interrupt clear-enable bits. Write: 0 = no effect 1 = disable interrupt. Read: 0 = interrupt disabled 1 = interrupt enabled.

4.2.4 Interrupt Set-pending Registers

The ISPR0 and ISPR1 registers force interrupts into the pending state, and show which interrupts are pending. See:

- the register summary in Table 4.2 (p. 88) for the register attributes
- Table 4.3 (p. 89) for which interrupts are controlled by each register.

The bit assignments are:

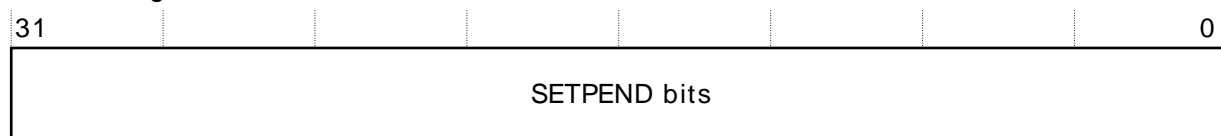

Table 4.6. ISPR bit assignments

Bits	Name	Function
[31:0]	SETPEND	Interrupt set-pending bits. Write: 0 = no effect 1 = changes interrupt state to pending. Read: 0 = interrupt is not pending 1 = interrupt is pending.

Note Writing 1 to the ISPR bit corresponding to:

- an interrupt that is pending has no effect
- a disabled interrupt sets the state of that interrupt to pending.

4.2.5 Interrupt Clear-pending Registers

The ICPR0 and ICPR1 registers remove the pending state from interrupts, and show which interrupts are pending. See:

- the register summary in Table 4.2 (p. 88) for the register attributes
- Table 4.3 (p. 89) for which interrupts are controlled by each register.

The bit assignments are:

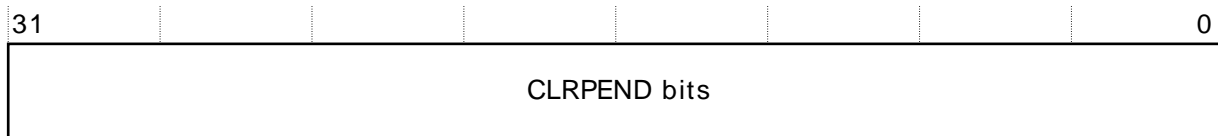

Table 4.7. ICPR bit assignments

Bits	Name	Function
[31:0]	CLRPEND	Interrupt clear-pending bits. Write: 0 = no effect 1 = removes pending state an interrupt. Read: 0 = interrupt is not pending 1 = interrupt is pending.

Note Writing 1 to an ICPR bit does not affect the active state of the corresponding interrupt.

4.2.6 Interrupt Active Bit Registers

The IABR0 and IABR1 registers indicate which interrupts are active. See:

- the register summary in Table 4.2 (p. 88) for the register attributes
- Table 4.3 (p. 89) for which interrupts are controlled by each register.

The bit assignments are:



Table 4.8. IABR bit assignments

Bits	Name	Function
[31:0]	ACTIVE	Interrupt active flags: 0 = interrupt not active 1 = interrupt active.

A bit reads as one if the status of the corresponding interrupt is active or active and pending.

4.2.7 Interrupt Priority Registers

The IPR0-IPRm registers provide an 3-bit priority field for each interrupt. These registers are byte-accessible. See the register summary in Table 4.2 (p. 88) for their attributes. Each register holds four priority fields, that map to four elements in the CMSIS interrupt priority array $IP[0]$ to $IP[n-1]$, as shown:

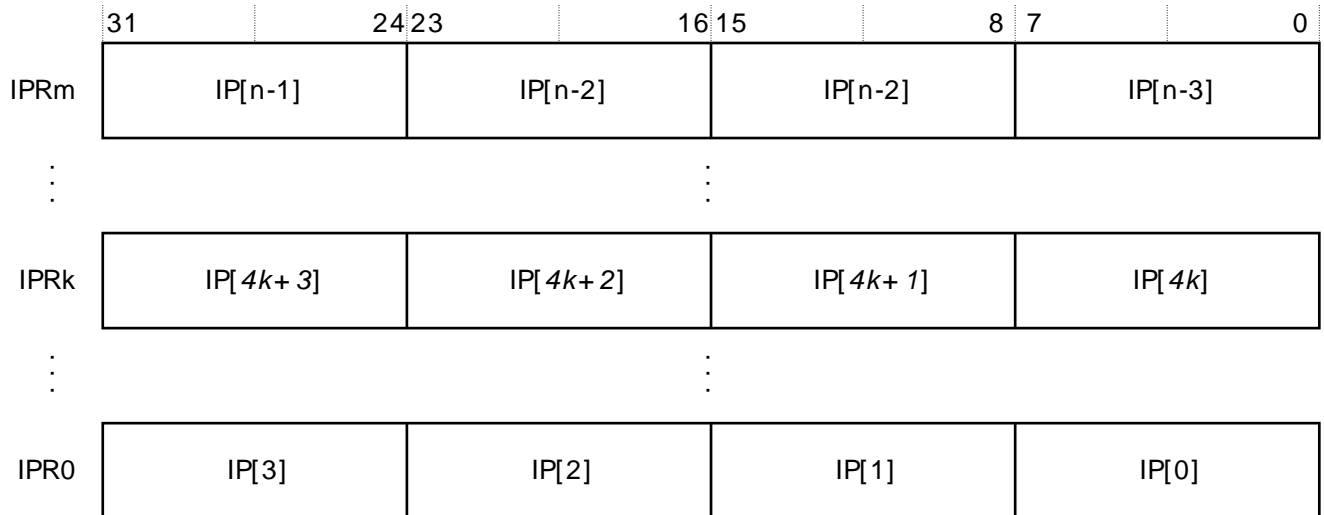

Table 4.9. IPR bit assignments

Bits	Name	Function
[31:24]	Priority, byte offset 3	Each priority field holds a priority value, 0-7. The lower the value, the greater the priority of the corresponding interrupt. Only bits[7:5] of each field are implemented, bits[4:0] read as zero and ignore writes.
[23:16]	Priority, byte offset 2	
[15:8]	Priority, byte offset 1	
[7:0]	Priority, byte offset 0	

See Section 4.2.1 (p. 89) for more information about the $IP[0]$ to $IP[n-1]$ interrupt priority array, that provides the software view of the interrupt priorities.

Find the IPR number and byte offset for interrupt N (n , the maximum number for N is given by Table 1.1 (p. 5) and subtracted by 1) as follows:

- the corresponding IPR number, k , is given by $k = N \text{ DIV } 4$
- the byte offset of the required Priority field in this register is $N \text{ MOD } 4$, where:
 - byte offset 0 refers to register bits[7:0]
 - byte offset 1 refers to register bits[15:8]

- byte offset 2 refers to register bits[23:16]
- byte offset 3 refers to register bits[31:24].

4.2.8 Software Trigger Interrupt Register

Write to the STIR to generate a *Software Generated Interrupt* (SGI). See the register summary in Table 4.2 (p. 88) for the STIR attributes.

When the USERSETMPEND bit in the SCR is set to 1, unprivileged software can access the STIR, see Section 4.3.7 (p. 100) .

Note

Only privileged software can enable unprivileged access to the STIR.

The bit assignments are:

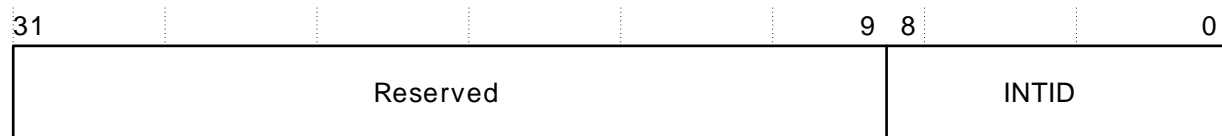

Table 4.10. STIR bit assignments

Bits	Field	Function
[31:9]	-	Reserved.
[8:0]	INTID	Interrupt ID of the required SGI, in the range 0 to (n-1), where n denotes the number of interrupts given by Table 1.1 (p. 5) . For example, a value of b000000011 specifies interrupt IRQ3.

4.2.9 Level-sensitive interrupts

All interrupt lines in the EFM32 devices are level sensitive interrupts. A level-sensitive interrupt is held asserted until the peripheral deasserts the interrupt signal. Typically this happens because the ISR accesses the peripheral, causing it to clear the interrupt request.

When the processor enters the ISR, it automatically removes the pending state from the interrupt, see Section 4.2.9.1 (p. 93). If the signal is not deasserted before the processor returns from the ISR, the interrupt becomes pending again, and the processor must execute its ISR again. This means that the peripheral can hold the interrupt signal asserted until it no longer needs servicing.

4.2.9.1 Hardware and software control of interrupts

The Cortex-M3 latches all interrupts. A peripheral interrupt becomes pending for one of the following reasons:

- the NVIC detects that the interrupt signal is HIGH and the interrupt is not active
- the NVIC detects a rising edge on the interrupt signal
- software writes to the corresponding interrupt set-pending register bit, see Section 4.2.4 (p. 90), or to the STIR to make an SGI pending, see Section 4.2.8 (p. 93) .

A pending interrupt remains pending until one of the following:

- The processor enters the ISR for the interrupt. This changes the state of the interrupt from pending to active. Then:
 - When the processor returns from the ISR, the NVIC samples the interrupt signal. If the signal is asserted, the state of the interrupt changes to pending, which might cause the processor to immediately re-enter the ISR. Otherwise, the state of the interrupt changes to inactive.
- Software writes to the corresponding interrupt clear-pending register bit.

If the interrupt signal is still asserted, the state of the interrupt does not change. Otherwise, the state of the interrupt changes to inactive.

4.2.10 NVIC design hints and tips

Ensure software uses correctly aligned register accesses. The processor does not support unaligned accesses to NVIC registers. See the individual register descriptions for the supported access sizes.

A interrupt can enter pending state even it is disabled.

Before programming VTOR to relocate the vector table, ensure the vector table entries of the new vector table are setup for fault handlers, NMI and all enabled exception like interrupts. For more information see Section 4.3.5 (p. 98) .

4.2.10.1 NVIC programming hints

Software uses the CPSIE I and CPSID I instructions to enable and disable interrupts. The CMSIS provides the following intrinsic functions for these instructions:

```
void __disable_irq(void) // Disable Interrupts
```

```
void __enable_irq(void) // Enable Interrupts
```

In addition, the CMSIS provides a number of functions for NVIC control, including:

Table 4.11. CMSIS functions for NVIC control

CMSIS interrupt control function	Description
void NVIC_SetPriorityGrouping(uint32_t priority_grouping)	Set the priority grouping
void NVIC_EnableIRQ(IRQn_t IRQn)	Enable IRQn
void NVIC_DisableIRQ(IRQn_t IRQn)	Disable IRQn
uint32_t NVIC_GetPendingIRQ (IRQn_t IRQn)	Return true (IRQ-Number) if IRQn is pending
void NVIC_SetPendingIRQ (IRQn_t IRQn)	Set IRQn pending
void NVIC_ClearPendingIRQ (IRQn_t IRQn)	Clear IRQn pending status
uint32_t NVIC_GetActive (IRQn_t IRQn)	Return the IRQ number of the active interrupt
void NVIC_SetPriority (IRQn_t IRQn, uint32_t priority)	Set priority for IRQn
uint32_t NVIC_GetPriority (IRQn_t IRQn)	Read priority of IRQn
void NVIC_SystemReset (void)	Reset the system

For more information about these functions see the CMSIS documentation.

4.3 System control block

The *System control block* (SCB) provides system implementation information, and system control. This includes configuration, control, and reporting of the system exceptions. The system control block registers are:

Table 4.12. Summary of the system control block registers

Address	Name	Type	Required privilege	Reset value	Description
0xE000E008	ACTLR	RW	Privileged	0x00000000	Section 4.3.2 (p. 95)

Address	Name	Type	Required privilege	Reset value	Description
0xE000ED00	CPUID	RO	Privileged	0x412FC23n	n=0 for devices with revision r2p0. n=1 for devices with revision r2p1. Section 4.3.3 (p. 96)
0xE000ED04	ICSR	RW ¹	Privileged	0x00000000	Section 4.3.4 (p. 96)
0xE000ED08	VTOR	RW	Privileged	0x00000000	Section 4.3.5 (p. 98)
0xE000ED0C	AIRCR	RW ¹	Privileged	0xFA050000	Section 4.3.6 (p. 99)
0xE000ED10	SCR	RW	Privileged	0x00000000	Section 4.3.7 (p. 100)
0xE000ED14	CCR	RW	Privileged	0x00000200	Section 4.3.8 (p. 101)
0xE000ED18	SHPR1	RW	Privileged	0x00000000	Section 4.3.9.1 (p. 103)
0xE000ED1C	SHPR2	RW	Privileged	0x00000000	Section 4.3.9.2 (p. 103)
0xE000ED20	SHPR3	RW	Privileged	0x00000000	Section 4.3.9.3 (p. 103)
0xE000ED24	SHCRS	RW	Privileged	0x00000000	Section 4.3.10 (p. 103)
0xE000ED28	CFSR	RW	Privileged	0x00000000	Section 4.3.11 (p. 105)
0xE000ED28	MMSR ²	RW	Privileged	0x00	Section 4.3.11.1 (p. 105)
0xE000ED29	BFSR ²	RW	Privileged	0x00	Section 4.3.11.2 (p. 107)
0xE000ED2A	UFSR ²	RW	Privileged	0x0000	Section 4.3.11.3 (p. 108)
0xE000ED2C	HFSR	RW	Privileged	0x00000000	Section 4.3.12 (p. 109)
0xE000ED34	MMAR	RW	Privileged	Unknown	Section 4.3.13 (p. 110)
0xE000ED38	BFAR	RW	Privileged	Unknown	Section 4.3.14 (p. 110)

¹See the register description for more information.

²A subregister of the CFSR.

4.3.1 The CMSIS mapping of the Cortex-M3 SCB registers

To improve software efficiency, the CMSIS simplifies the SCB register presentation. In the CMSIS, the byte array SHP[0] to SHP[12] corresponds to the registers SHPR1-SHPR3.

4.3.2 Auxiliary Control Register

The ACTLR provides disable bits for the following processor functions:

- IT folding
- write buffer use for accesses to the default memory map
- interruption of multi-cycle instructions.

See the register summary in Table 4.12 (p. 94) for the ACTLR attributes. The bit assignments are:

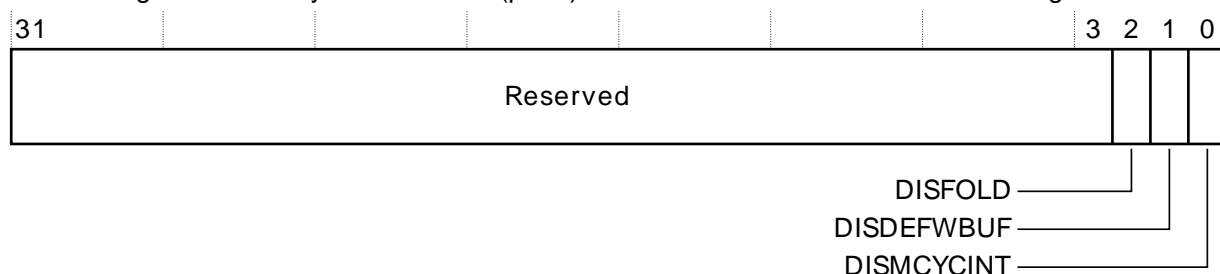

Table 4.13. ACTLR bit assignments

Bits	Name	Function
[31:3]	-	Reserved

Bits	Name	Function
[2]	DISFOLD	When set to 1, disables IT folding. see Section 4.3.2.1 (p. 96) for more information.
[1]	DISDEFWBUF	When set to 1, disables write buffer use during default memory map accesses. This causes all bus faults to be precise bus faults but decreases performance because any store to memory must complete before the processor can execute the next instruction.
<p>Note This bit only affects write buffers implemented in the Cortex-M3 processor.</p>		
[0]	DISMCYCINT	When set to 1, disables interruption of load multiple and store multiple instructions. This increases the interrupt latency of the processor because any LDM or STM must complete before the processor can stack the current state and enter the interrupt handler.

4.3.2.1 About IT folding

In some situations, the processor can start executing the first instruction in an IT block while it is still executing the `IT` instruction. This behavior is called IT folding, and improves performance. However, IT folding can cause jitter in looping. If a task must avoid jitter, set the DISFOLD bit to 1 before executing the task, to disable IT folding.

4.3.3 CPUID Base Register

The CPUID register contains the processor part number, version, and implementation information. See the register summary in Table 4.12 (p. 94) for its attributes. The bit assignments are:

31	24 23	20 19	16 15	4 3	0
Implementer	Variant	Constant	PartNo	Revision	

Table 4.14. CPUID register bit assignments

Bits	Name	Function
[31:24]	Implementer	Implementer code: 0x41 = ARM
[23:20]	Variant	Variant number, the r value in the <i>rnpr</i> product revision identifier: 0x2 = r2pX
[19:16]	Constant	Reads as 0xF
[15:4]	PartNo	Part number of the processor: 0xC23 = Cortex-M3
[3:0]	Revision	Revision number, the p value in the <i>rnpr</i> product revision identifier: 0x0 = rXp0 0x1 = rXp1

4.3.4 Interrupt Control and State Register

The ICSR:

- provides:
 - a set-pending bit for the *Non-Maskable Interrupt (NMI)* exception
 - set-pending and clear-pending bits for the PendSV and SysTick exceptions
- indicates:
 - the exception number of the exception being processed
 - whether there are preempted active exceptions
 - the exception number of the highest priority pending exception
 - whether any interrupts are pending.

See the register summary in Table 4.12 (p. 94), and the Type descriptions in Table 4.15 (p. 97), for the ICSR attributes. The bit assignments are:

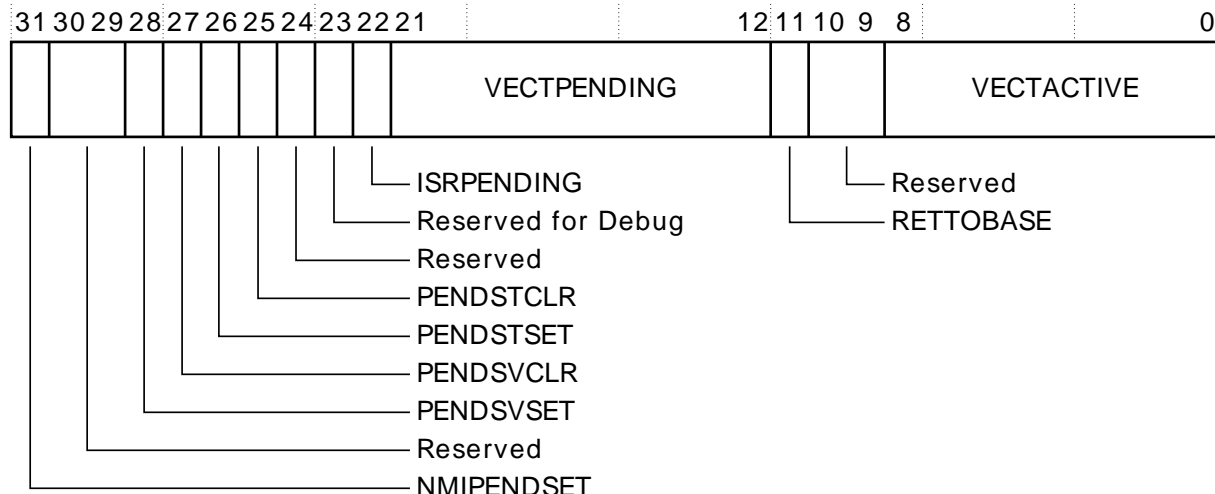

Table 4.15. ICSR bit assignments

Bits	Name	Type	Function
[31]	NMIPENDSET	RW	NMI set-pending bit. Write: 0 = no effect 1 = changes NMI exception state to pending. Read: 0 = NMI exception is not pending 1 = NMI exception is pending. Because NMI is the highest-priority exception, normally the processor enter the NMI exception handler as soon as it registers a write of 1 to this bit, and entering the handler clears this bit to 0. A read of this bit by the NMI exception handler returns 1 only if the NMI signal is reasserted while the processor is executing that handler.
[30:29]	-	-	Reserved.
[28]	PENDSVSET	RW	PendSV set-pending bit. Write: 0 = no effect 1 = changes PendSV exception state to pending. Read: 0 = PendSV exception is not pending 1 = PendSV exception is pending. Writing 1 to this bit is the only way to set the PendSV exception state to pending.
[27]	PENDSVCLR	WO	PendSV clear-pending bit. Write: 0 = no effect 1 = removes the pending state from the PendSV exception.
[26]	PENDSTSET	RW	SysTick exception set-pending bit. Write: 0 = no effect 1 = changes SysTick exception state to pending. Read: 0 = SysTick exception is not pending 1 = SysTick exception is pending.

Bits	Name	Type	Function
[25]	PENDSTCLR	WO	SysTick exception clear-pending bit. Write: 0 = no effect 1 = removes the pending state from the SysTick exception. This bit is WO. On a register read its value is Unknown.
[24]	-	-	Reserved.
[23]	Reserved for Debug use	RO	This bit is reserved for Debug use and reads-as-zero when the processor is not in Debug.
[22]	ISR_PENDING	RO	Interrupt pending flag, excluding NMI and Faults: 0 = interrupt not pending 1 = interrupt pending.
[21:18]	-	-	Reserved.
[17:12]	VECT_PENDING	RO	Indicates the exception number of the highest priority pending enabled exception: 0 = no pending exceptions Nonzero = the exception number of the highest priority pending enabled exception. The value indicated by this field includes the effect of the BASEPRI and FAULTMASK registers, but not any effect of the PRIMASK register.
[11]	RETTOBASE	RO	Indicates whether there are preempted active exceptions: 0 = there are preempted active exceptions to execute 1 = there are no active exceptions, or the currently-executing exception is the only active exception.
[10:9]	-	-	Reserved.
[8:0]	VECT_ACTIVE ¹	RO	Contains the active exception number: 0 = Thread mode Nonzero = The exception number ¹ of the currently active exception.

Note

Subtract 16 from this value to obtain the IRQ number required to index into the Interrupt Clear-Enable, Set-Enable, Clear-Pending, Set-Pending, or Priority Registers, see Table 2.5 (p. 10) .

¹This is the same value as IPSR bits[8:0], see Section 2.1.3.5.2 (p. 10) .

When you write to the ICSR, the effect is Unpredictable if you:

- write 1 to the PENDSVSET bit and write 1 to the PENDSVCLR bit
- write 1 to the PENDSTSET bit and write 1 to the PENDSTCLR bit.

4.3.5 Vector Table Offset Register

The VTOR indicates the offset of the vector table base address from memory address 0x00000000. See the register summary in Table 4.12 (p. 94) for its attributes.

The bit assignments are:

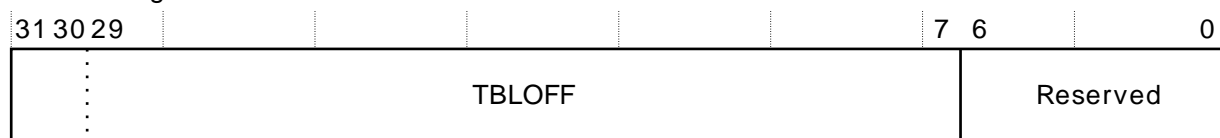

Reserved in some devices
(See note below)

Table 4.16. VTOR bit assignments

Bits	Name	Function
[31:30]	-	Reserved (in some devices these bits are part of the TBLOFF bitfield as explained below).
[29(31):7]	TBLOFF	Vector table base offset field. It contains bits[29:7] (bits[31:7] for Cortex-M3 revision r2p1 and later) of the offset of the table base from the bottom of the memory map. Table 1.1 (p. 5) shows the Cortex-M3 revision number for the EFM32 device series.
<p>Note</p> <p>Bit[29] (bit 31 in Cortex-M3 revision r2p1 and later) determines whether the vector table is in the code or SRAM memory region:</p> <ul style="list-style-type: none"> • 0 = code • 1 = SRAM. <p>Bit[29(31)] is sometimes called the TBLBASE bit.</p>		
[6:0]	-	Reserved.

When setting TBLOFF, you must align the offset to the number of exception entries in the vector table. The recommended alignment is 64 words, which covers all EFM32 interrupts and the 16 internal Cortex-M3 exceptions. If you require 16 interrupts or less, the alignment can be set to 32 words.

Note Table alignment requirements mean that bits[6:0] of the table offset are always zero.

4.3.6 Application Interrupt and Reset Control Register

The AIRCR provides priority grouping control for the exception model, endian status for data accesses, and reset control of the system. See the register summary in Table 4.12 (p. 94) and Table 4.17 (p. 99) for its attributes.

To write to this register, you must write 0x5VA to the VECTKEY field, otherwise the processor ignores the write.

The bit assignments are:

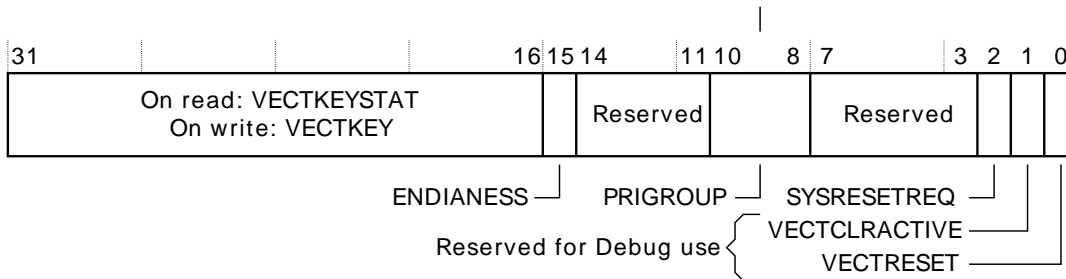

Table 4.17. AIRCR bit assignments

Bits	Name	Type	Function
[31:16]	Write: VECTKEYSTAT Read: VECTKEY	RW	Register key: Reads as 0x05FA On writes, write 0x5FA to VECTKEY, otherwise the write is ignored.
[15]	ENDIANESS	RO	Always read as 0 (Little-endian)
[14:11]	-	-	Reserved
[10:8]	PRIGROUP	R/W	Interrupt priority grouping field. This field determines the split of group priority from subpriority, see Section 4.3.6.1 (p. 100) .
[7:3]	-	-	Reserved.

Bits	Name	Type	Function
[2]	SYSRESETREQ	WO	System reset request: 0 = no system reset request 1 = asserts a signal to the EFM32 Reset Management Unit (RMU) to request a reset. This is intended to force a large system reset of all major components except for debug. This bit reads as 0.
[1]	VECTCLRACTIVE	WO	Reserved for Debug use. This bit reads as 0. When writing to the register you must write 0 to this bit, otherwise behavior is Unpredictable.
[0]	VECTRESET	WO	Reserved for Debug use. This bit reads as 0. When writing to the register you must write 0 to this bit, otherwise behavior is Unpredictable.

4.3.6.1 Binary point

The PRIGROUP field indicates the position of the binary point that splits the PRI_n fields in the Interrupt Priority Registers into separate *group priority* and *subpriority* fields. Table 4.18 (p. 100) shows how the PRIGROUP value controls this split.

Table 4.18. Priority grouping

PRIGROUP	Interrupt priority level value, PRI _M [7:0]			Number of	
	Binary point ¹	Group priority bits	Subpriority bits	Group priorities	Subpriorities
b100-b000	bxxx.00000	[7:5]	None	8	1
b101	bxx.y00000	[7:6]	[5]	4	2
b110	bx.yy00000	[7]	[6:5]	2	4
b111	b.yyy00000	None	[7:5]	1	8

¹PRI_n[7:0] field showing the binary point. x denotes a group priority field bit, and y denotes a subpriority field bit.

Note

Determining preemption of an exception uses only the group priority field, see Section 2.3.6 (p. 26) .

4.3.7 System Control Register

The SCR controls features of entry to and exit from low power state. See the register summary in Table 4.12 (p. 94) for its attributes. The bit assignments are:

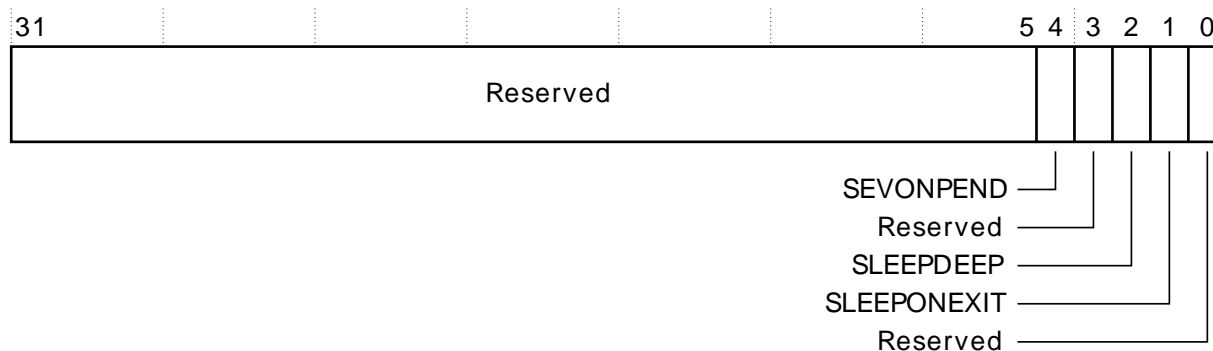

Table 4.19. SCR bit assignments

Bits	Name	Function
[31:5]	-	Reserved.

Bits	Name	Function
[4]	SEVONPEND	Send Event on Pending bit: 0 = only enabled interrupts or events can wakeup the processor, disabled interrupts are excluded 1 = enabled events and all interrupts, including disabled interrupts, can wakeup the processor. When an event or interrupt enters pending state, the event signal wakes up the processor from WFE. If the processor is not waiting for an event, the event is registered and affects the next WFE. The processor also wakes up on execution of an SEV instruction or an external event.
[3]	-	Reserved.
[2]	SLEEPDEEP	Controls whether the processor uses sleep or deep sleep as its low power mode: 0 = sleep 1 = deep sleep.
[1]	SLEEPONEXIT	Indicates sleep-on-exit when returning from Handler mode to Thread mode: 0 = do not sleep when returning to Thread mode. 1 = enter sleep, or deep sleep, on return from an ISR. Setting this bit to 1 enables an interrupt driven application to avoid returning to an empty main application.
[0]	-	Reserved.

4.3.8 Configuration and Control Register

The CCR controls entry to Thread mode and enables:

- the handlers for NMI, hard fault and faults escalated by FAULTMASK to ignore bus faults
- trapping of divide by zero and unaligned accesses
- access to the STIR by unprivileged software, see Section 4.2.8 (p. 93) .

See the register summary in Table 4.12 (p. 94) for the CCR attributes.

The bit assignments are:

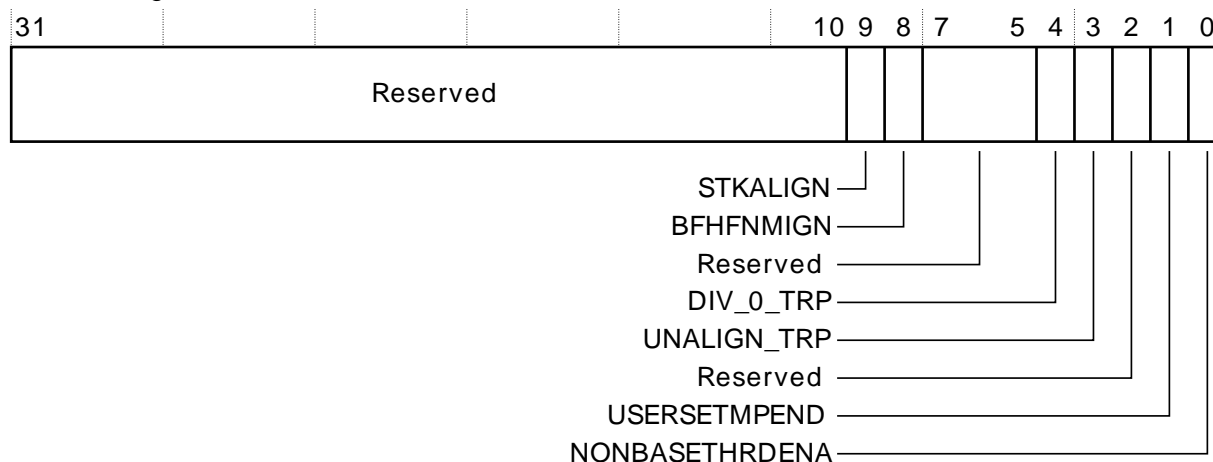

Table 4.20. CCR bit assignments

Bits	Name	Function
[31:10]	-	Reserved.
[9]	STKALIGN	Indicates stack alignment on exception entry: 0 = 4-byte aligned 1 = 8-byte aligned.

Bits	Name	Function
		On exception entry, the processor uses bit[9] of the stacked PSR to indicate the stack alignment. On return from the exception it uses this stacked bit to restore the correct stack alignment.
[8]	BFHFMIGN	<p>Enables handlers with priority -1 or -2 to ignore data bus faults caused by load and store instructions. This applies to the hard fault, NMI, and FAULTMASK escalated handlers:</p> <p>0 = data bus faults caused by load and store instructions cause a lock-up</p> <p>1 = handlers running at priority -1 and -2 ignore data bus faults caused by load and store instructions.</p> <p>Set this bit to 1 only when the handler and its data are in absolutely safe memory. The normal use of this bit is to probe system devices and bridges to detect control path problems and fix them.</p>
[7:5]	-	Reserved.
[4]	DIV_0_TRP	<p>Enables faulting or halting when the processor executes an SDIV or UDIV instruction with a divisor of 0:</p> <p>0 = do not trap divide by 0</p> <p>1 = trap divide by 0.</p> <p>When this bit is set to 0, a divide by zero returns a quotient of 0.</p>
[3]	UNALIGN_TRP	<p>Enables unaligned access traps:</p> <p>0 = do not trap unaligned halfword and word accesses 1 = trap unaligned halfword and word accesses.</p> <p>If this bit is set to 1, an unaligned access generates a usage fault.</p> <p>Unaligned LDM, STM, LDRD, and STRD instructions always fault irrespective of whether UNALIGN_TRP is set to 1.</p>
[2]	-	Reserved.
[1]	USERSETMPEND	<p>Enables unprivileged software access to the STIR, see Section 4.2.8 (p. 93) :</p> <p>0 = disable 1 = enable.</p>
[0]	NONEBASETHRDENA	<p>Indicates how the processor enters Thread mode:</p> <p>0 = processor can enter Thread mode only when no exception is active.</p> <p>1 = processor can enter Thread mode from any level under the control of an EXC_RETURN value, see Section 2.3.7.2 (p. 27) .</p>

4.3.9 System Handler Priority Registers

The SHPR1-SHPR3 registers set the priority level, 0 to 7 of the exception handlers that have configurable priority.

SHPR1-SHPR3 are byte accessible. See the register summary in Table 4.12 (p. 94) for their attributes.

The system fault handlers and the priority field and register for each handler are:

Table 4.21. System fault handler priority fields

Handler	Field	Register description
Memory management fault	PRI_4	Section 4.3.9.1 (p. 103)
Bus fault	PRI_5	
Usage fault	PRI_6	
SVCcall	PRI_11	Section 4.3.9.2 (p. 103)
PendSV	PRI_14	Section 4.3.9.2 (p. 103)

Handler	Field	Register description
SysTick	PRI_15	

Each PRI_N field is 8 bits wide, but the EFM32 implements only bits[7:5] of each field, and bits[4:0] read as zero and ignore writes.

4.3.9.1 System Handler Priority Register 1

The bit assignments are:

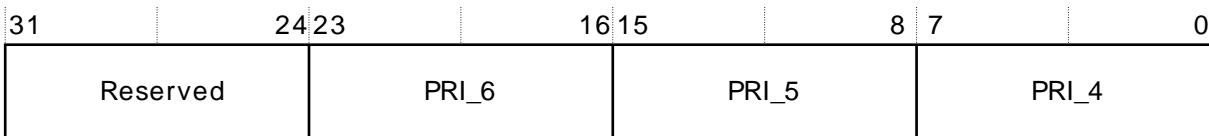

Table 4.22. SHPR1 register bit assignments

Bits	Name	Function
[31:24]	PRI_7	Reserved
[23:16]	PRI_6	Priority of system handler 6, usage fault
[15:8]	PRI_5	Priority of system handler 5, bus fault
[7:0]	PRI_4	Priority of system handler 4, memory management fault

4.3.9.2 System Handler Priority Register 2

The bit assignments are:

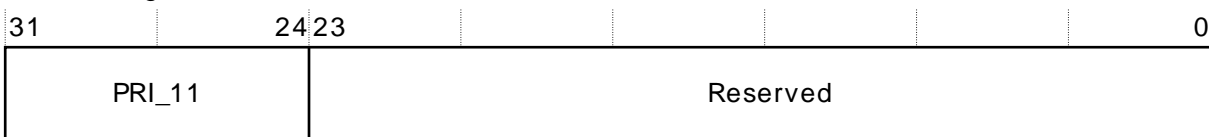

Table 4.23. SHPR2 register bit assignments

Bits	Name	Function
[31:24]	PRI_11	Priority of system handler 11, SVCcall
[23:0]	-	Reserved

4.3.9.3 System Handler Priority Register 3

The bit assignments are:

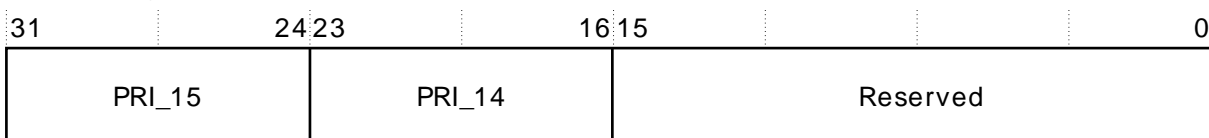

Table 4.24. SHPR3 register bit assignments

Bits	Name	Function
[31:24]	PRI_15	Priority of system handler 15, SysTick exception
[23:16]	PRI_14	Priority of system handler 14, PendSV
[15:0]	-	Reserved

4.3.10 System Handler Control and State Register

The SHCSR enables the system handlers, and indicates:

- the pending status of the bus fault, memory management fault, and SVC exceptions
- the active status of the system handlers.

See the register summary in Table 4.12 (p. 94) for the SHCSR attributes. The bit assignments are:

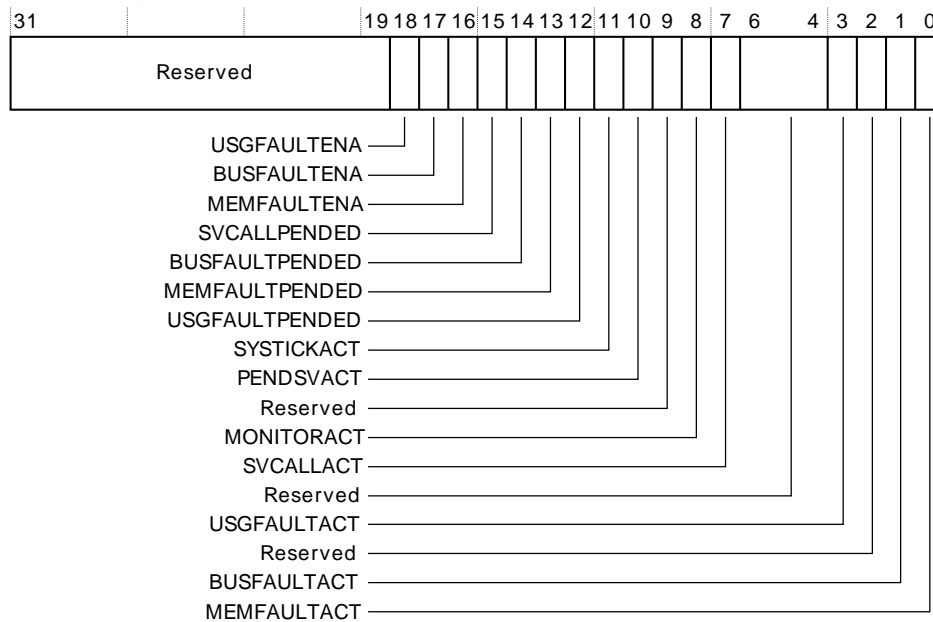

Table 4.25. SHCSR bit assignments

Bits	Name	Function
[31:19]	-	Reserved
[18]	USGFAULTENA	Usage fault enable bit, set to 1 to enable ¹
[17]	BUSFAULTENA	Bus fault enable bit, set to 1 to enable ¹
[16]	MEMFAULTENA	Memory management fault enable bit, set to 1 to enable ¹
[15]	SVCALLPENDEd	SVC call pending bit, reads as 1 if exception is pending ²
[14]	BUSFAULTPENDEd	Bus fault exception pending bit, reads as 1 if exception is pending ²
[13]	MEMFAULTPENDEd	Memory management fault exception pending bit, reads as 1 if exception is pending ²
[12]	USGFAULTPENDEd	Usage fault exception pending bit, reads as 1 if exception is pending ²
[11]	SYSTICKACT	SysTick exception active bit, reads as 1 if exception is active ³
[10]	PENDSVACT	PendSV exception active bit, reads as 1 if exception is active
[9]	-	Reserved
[8]	MONITORACT	Debug monitor active bit, reads as 1 if Debug monitor is active
[7]	SVCALLACT	SVC call active bit, reads as 1 if SVC call is active
[6:4]	-	Reserved
[3]	USGFAULTACT	Usage fault exception active bit, reads as 1 if exception is active
[2]	-	Reserved
[1]	BUSFAULTACT	Bus fault exception active bit, reads as 1 if exception is active
[0]	MEMFAULTACT	Memory management fault exception active bit, reads as 1 if exception is active

¹Enable bits, set to 1 to enable the exception, or set to 0 to disable the exception.

²Pending bits, read as 1 if the exception is pending, or as 0 if it is not pending. You can write to these bits to change the pending status of the exceptions.

³Active bits, read as 1 if the exception is active, or as 0 if it is not active. You can write to these bits to change the active status of the exceptions, but see the Caution in this section.

If you disable a system handler and the corresponding fault occurs, the processor treats the fault as a hard fault.

You can write to this register to change the pending or active status of system exceptions. An OS kernel can write to the active bits to perform a context switch that changes the current exception type.

Caution

- Software that changes the value of an active bit in this register without correct adjustment to the stacked content can cause the processor to generate a fault exception. Ensure software that writes to this register retains and subsequently restores the current active status.
- After you have enabled the system handlers, if you have to change the value of a bit in this register you must use a read-modify-write procedure to ensure that you change only the required bit.

4.3.11 Configurable Fault Status Register

The CFSR indicates the cause of a memory management fault, bus fault, or usage fault. See the register summary in Table 4.12 (p. 94) for its attributes. The bit assignments are:

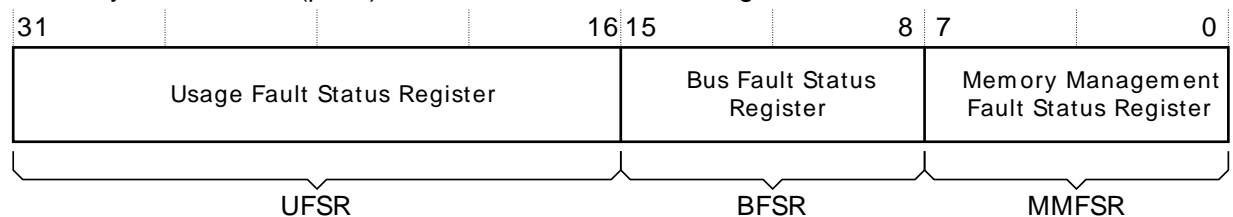

The following subsections describe the subregisters that make up the CFSR:

- Section 4.3.11.1 (p. 105)
- Section 4.3.11.2 (p. 107)
- Section 4.3.11.3 (p. 108) .

The CFSR is byte accessible. You can access the CFSR or its subregisters as follows:

- access the complete CFSR with a word access to 0xE00ED28
- access the MMFSR with a byte access to 0xE00ED28
- access the MMFSR and BFSR with a halfword access to 0xE00ED28
- access the BFSR with a byte access to 0xE00ED29
- access the UFSR with a halfword access to 0xE00ED2A.

4.3.11.1 Memory Management Fault Status Register

The flags in the MMFSR indicate the cause of memory access faults. The bit assignments are:

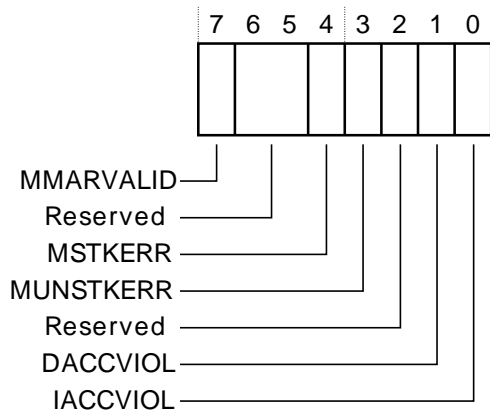

Table 4.26. MMFSR bit assignments

Bits	Name	Function
[7]	MMARVALID	<p>Memory Management Fault Address Register (MMAR) valid flag:</p> <p>0 = value in MMAR is not a valid fault address</p> <p>1 = MMAR holds a valid fault address.</p> <p>If a memory management fault occurs and is escalated to a hard fault because of priority, the hard fault handler must set this bit to 0. This prevents problems on return to a stacked active memory management fault handler whose MMAR value has been overwritten.</p>
[6:5]	-	Reserved.
[4]	MSTKERR	<p>Memory manager fault on stacking for exception entry:</p> <p>0 = no stacking fault</p> <p>1 = stacking for an exception entry has caused one or more access violations.</p> <p>When this bit is 1, the SP is still adjusted but the values in the context area on the stack might be incorrect. The processor has not written a fault address to the MMAR.</p>
[3]	MUNSTKERR	<p>Memory manager fault on unstacking for a return from exception:</p> <p>0 = no unstacking fault</p> <p>1 = unstack for an exception return has caused one or more access violations.</p> <p>This fault is chained to the handler. This means that when this bit is 1, the original return stack is still present. The processor has not adjusted the SP from the failing return, and has not performed a new save. The processor has not written a fault address to the MMAR.</p>
[2]	-	Reserved
[1]	DACCVIOL	<p>Data access violation flag:</p> <p>0 = no data access violation fault</p> <p>1 = the processor attempted a load or store at a location that does not permit the operation.</p> <p>When this bit is 1, the PC value stacked for the exception return points to the faulting instruction. The processor has loaded the MMAR with the address of the attempted access.</p>
[0]	IACCVIOL	<p>Instruction access violation flag:</p> <p>0 = no instruction access violation fault</p> <p>1 = the processor attempted an instruction fetch from a location that does not permit execution.</p> <p>This fault occurs on any access to an XN region, even when the MPU is disabled or not present in the device.</p> <p>When this bit is 1, the PC value stacked for the exception return points to the faulting instruction. The processor has not written a fault address to the MMAR.</p>

4.3.11.2 Bus Fault Status Register

The flags in the BFSR indicate the cause of a bus access fault. The bit assignments are:

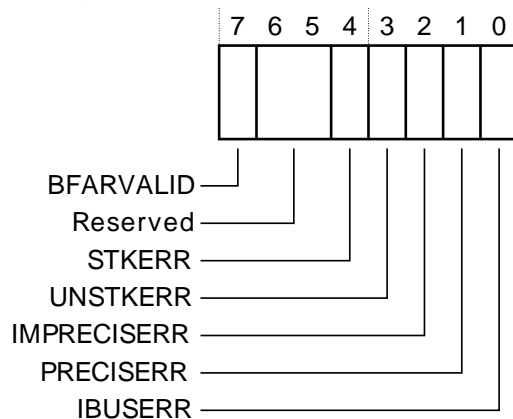

Table 4.27. BFSR bit assignments

Bits	Name	Function
[7]	B FARVALID	<p><i>Bus Fault Address Register (BFAR) valid flag:</i></p> <p>0 = value in BFAR is not a valid fault address</p> <p>1 = BFAR holds a valid fault address.</p> <p>The processor sets this bit to 1 after a bus fault where the address is known. Other faults can set this bit to 0, such as a memory management fault occurring later.</p> <p>If a bus fault occurs and is escalated to a hard fault because of priority, the hard fault handler must set this bit to 0. This prevents problems if returning to a stacked active bus fault handler whose BFAR value has been overwritten.</p>
[6:5]	-	Reserved.
[4]	STKERR	<p>Bus fault on stacking for exception entry:</p> <p>0 = no stacking fault</p> <p>1 = stacking for an exception entry has caused one or more bus faults.</p> <p>When the processor sets this bit to 1, the SP is still adjusted but the values in the context area on the stack might be incorrect. The processor does not write a fault address to the BFAR.</p>
[3]	UNSTKERR	<p>Bus fault on unstacking for a return from exception:</p> <p>0 = no unstacking fault</p> <p>1 = unstack for an exception return has caused one or more bus faults.</p> <p>This fault is chained to the handler. This means that when the processor sets this bit to 1, the original return stack is still present. The processor does not adjust the SP from the failing return, does not performed a new save, and does not write a fault address to the BFAR.</p>
[2]	IMPRECISERR	<p>Imprecise data bus error:</p> <p>0 = no imprecise data bus error</p> <p>1 = a data bus error has occurred, but the return address in the stack frame is not related to the instruction that caused the error.</p> <p>When the processor sets this bit to 1, it does not write a fault address to the BFAR.</p> <p>This is an asynchronous fault. Therefore, if it is detected when the priority of the current process is higher than the bus fault priority, the bus fault becomes pending and becomes active only when the processor returns from all higher priority processes. If a precise fault occurs before the processor enters the handler for the imprecise bus fault, the handler detects both IMPRECISERR set to 1 and one of the precise fault status bits set to 1.</p>
[1]	PRECISERR	<p>Precise data bus error:</p> <p>0 = no precise data bus error</p>

Bits	Name	Function
		1 = a data bus error has occurred, and the PC value stacked for the exception return points to the instruction that caused the fault. When the processor sets this bit is 1, it writes the faulting address to the BFAR.
[0]	IBUSERR	Instruction bus error: 0 = no instruction bus error 1 = instruction bus error. The processor detects the instruction bus error on prefetching an instruction, but it sets the IBUSERR flag to 1 only if it attempts to issue the faulting instruction. When the processor sets this bit is 1, it does not write a fault address to the BFAR.

4.3.11.3 Usage Fault Status Register

The UFSR indicates the cause of a usage fault. The bit assignments are:

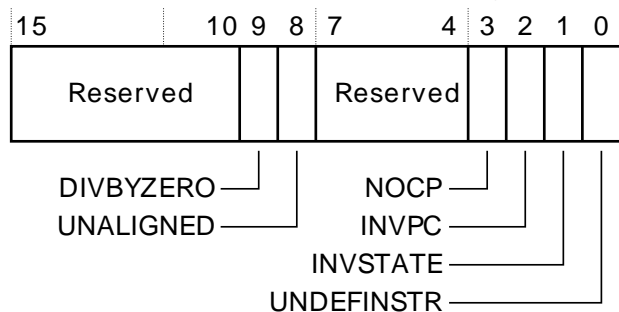

Table 4.28. UFSR bit assignments

Bits	Name	Function
[15:10]	-	Reserved.
[9]	DIVBYZERO	Divide by zero usage fault: 0 = no divide by zero fault, or divide by zero trapping not enabled 1 = the processor has executed an SDIV or UDIV instruction with a divisor of 0. When the processor sets this bit to 1, the PC value stacked for the exception return points to the instruction that performed the divide by zero. Enable trapping of divide by zero by setting the DIV_0_TRP bit in the CCR to 1, see Section 4.3.8 (p. 101) .
[8]	UNALIGNED	Unaligned access usage fault: 0 = no unaligned access fault, or unaligned access trapping not enabled 1 = the processor has made an unaligned memory access. Enable trapping of unaligned accesses by setting the UNALIGN_TRP bit in the CCR to 1, see Section 4.3.8 (p. 101) . Unaligned LDM, STM, LDRD, and STRD instructions always fault irrespective of the setting of UNALIGN_TRP.
[7:4]	-	Reserved.
[3]	NOCP	No coprocessor usage fault. The processor does not support coprocessor instructions: 0 = no usage fault caused by attempting to access a coprocessor 1 = the processor has attempted to access a coprocessor.
[2]	INVPC	Invalid PC load usage fault, caused by an invalid PC load by EXC_RETURN: 0 = no invalid PC load usage fault 1 = the processor has attempted an illegal load of EXC_RETURN to the PC, as a result of an invalid context, or an invalid EXC_RETURN value.

Bits	Name	Function
		When this bit is set to 1, the PC value stacked for the exception return points to the instruction that tried to perform the illegal load of the PC.
[1]	INVSTATE	Invalid state usage fault: 0 = no invalid state usage fault 1 = the processor has attempted to execute an instruction that makes illegal use of the EPSR. When this bit is set to 1, the PC value stacked for the exception return points to the instruction that attempted the illegal use of the EPSR. This bit is not set to 1 if an undefined instruction uses the EPSR.
[0]	UNDEFINSTR	Undefined instruction usage fault: 0 = no undefined instruction usage fault 1 = the processor has attempted to execute an undefined instruction. When this bit is set to 1, the PC value stacked for the exception return points to the undefined instruction. An undefined instruction is an instruction that the processor cannot decode.

Note

The UFSR bits are sticky. This means as one or more fault occurs, the associated bits are set to 1. A bit that is set to 1 is cleared to 0 only by writing 1 to that bit, or by a reset.

4.3.12 Hard Fault Status Register

The HFSR gives information about events that activate the hard fault handler. See the register summary in Table 4.12 (p. 94) for its attributes.

This register is read, write to clear. This means that bits in the register read normally, but writing 1 to any bit clears that bit to 0. The bit assignments are:

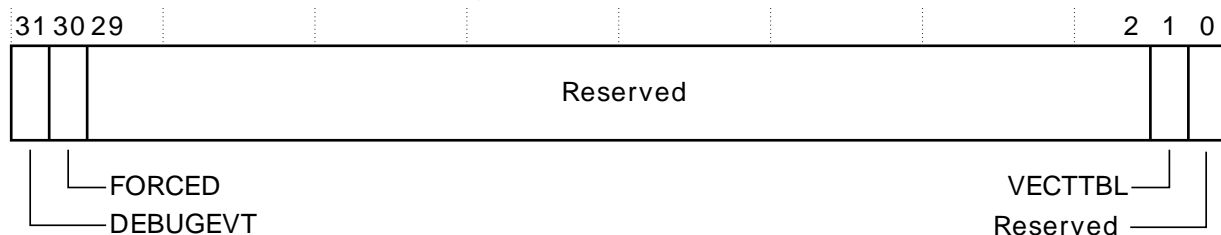

Table 4.29. HFSR bit assignments

Bits	Name	Function
[31]	DEBUGEVT	Reserved for Debug use. When writing to the register you must write 0 to this bit, otherwise behavior is Unpredictable.
[30]	FORCED	Indicates a forced hard fault, generated by escalation of a fault with configurable priority that cannot be handles, either because of priority or because it is disabled: 0 = no forced hard fault 1 = forced hard fault. When this bit is set to 1, the hard fault handler must read the other fault status registers to find the cause of the fault.
[29:2]	-	Reserved.
[1]	VECTTBL	Indicates a bus fault on a vector table read during exception processing: 0 = no bus fault on vector table read 1 = bus fault on vector table read. This error is always handled by the hard fault handler.

Bits	Name	Function
		When this bit is set to 1, the PC value stacked for the exception return points to the instruction that was preempted by the exception.
[0]	-	Reserved.

Note

The HFSR bits are sticky. This means as one or more fault occurs, the associated bits are set to 1. A bit that is set to 1 is cleared to 0 only by writing 1 to that bit, or by a reset.

4.3.13 Memory Management Fault Address Register

The MMFAR contains the address of the location that generated a memory management fault. See the register summary in Table 4.12 (p. 94) for its attributes. The bit assignments are:

Table 4.30. MMFAR bit assignments

Bits	Name	Function
[31:0]	ADDRESS	When the MMARVALID bit of the MMFSR is set to 1, this field holds the address of the location that generated the memory management fault

When an unaligned access faults, the address is the actual address that faulted. Because a single read or write instruction can be split into multiple aligned accesses, the fault address can be any address in the range of the requested access size.

Flags in the MMFSR indicate the cause of the fault, and whether the value in the MMFAR is valid. See Section 4.3.11.1 (p. 105) .

4.3.14 Bus Fault Address Register

The BFAR contains the address of the location that generated a bus fault. See the register summary in Table 4.12 (p. 94) for its attributes. The bit assignments are:

Table 4.31. BFAR bit assignments

Bits	Name	Function
[31:0]	ADDRESS	When the BFARVALID bit of the BFSR is set to 1, this field holds the address of the location that generated the bus fault

When an unaligned access faults the address in the BFAR is the one requested by the instruction, even if it is not the address of the fault.

Flags in the BFSR indicate the cause of the fault, and whether the value in the BFAR is valid. See Section 4.3.11.2 (p. 107) .

4.3.15 System control block design hints and tips

Ensure software uses aligned accesses of the correct size to access the system control block registers:

- except for the CFSR and SHPR1-SHPR3, it must use aligned word accesses
- for the CFSR and SHPR1-SHPR3 it can use byte or aligned halfword or word accesses.

The processor does not support unaligned accesses to system control block registers.

In a fault handler, to determine the true faulting address:

1. Read and save the MMFAR or BFAR value.
2. Read the MMARVALID bit in the MMFSR, or the BFARVALID bit in the BFSR. The MMFAR or BFAR address is valid only if this bit is 1.

Software must follow this sequence because another higher priority exception might change the MMFAR or BFAR value. For example, if a higher priority handler preempts the current fault handler, the other fault might change the MMFAR or BFAR value.

4.4 System timer, SysTick

The processor has a 24-bit system timer, SysTick, that counts down from the reload value to zero, reloads (wraps to) the value in the LOAD register on the next clock edge, then counts down on subsequent clocks.

Note

When the processor is halted for debugging the counter does not decrement.

The system timer registers are:

Table 4.32. System timer registers summary

Address	Name	Type	Required privilege	Reset value	Description
0xE000E010	CTRL	RW	Privileged	0x00000004	Section 4.4.1 (p. 111)
0xE000E014	LOAD	RW	Privileged	0x00000000	Section 4.4.2 (p. 112)
0xE000E018	VAL	RW	Privileged	0x00000000	Section 4.4.3 (p. 112)
0xE000E01C	CALIB	RO	Privileged	0x400036B0	Section 4.4.4 (p. 113)

[†]SysTick calibration value.

4.4.1 SysTick Control and Status Register

The SysTick CTRL register enables the SysTick features. See the register summary in Table 4.32 (p. 111) for its attributes. The bit assignments are:

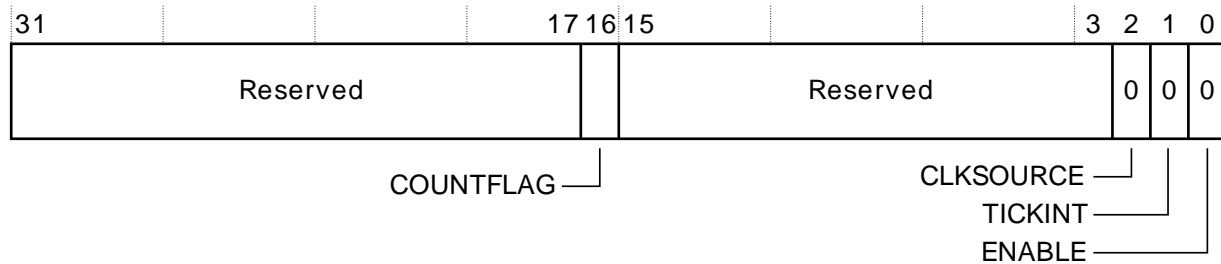

Table 4.33. SysTick CTRL register bit assignments

Bits	Name	Function
[31:17]	-	Reserved.
[16]	COUNTFLAG	Returns 1 if timer counted to 0 since last time this was read.
[15:3]	-	Reserved.
[2]	CLKSOURCE	Indicates the clock source: 0 = Bit 0 of RTC counter value 1 = HFCORECLK
[1]	TICKINT	Enables SysTick exception request: 0 = counting down to zero does not assert the SysTick exception request 1 = counting down to zero to asserts the SysTick exception request. Software can use COUNTFLAG to determine if SysTick has ever counted to zero.

Bits	Name	Function
[0]	ENABLE	Enables the counter: 0 = counter disabled 1 = counter enabled.

When ENABLE is set to 1, the counter loads the RELOAD value from the LOAD register and then counts down. On reaching 0, it sets the COUNTFLAG to 1 and optionally asserts the SysTick depending on the value of TICKINT. It then loads the RELOAD value again, and begins counting.

4.4.2 SysTick Reload Value Register

The LOAD register specifies the start value to load into the VAL register. See the register summary in Table 4.32 (p. 111) for its attributes. The bit assignments are:

31	24	23	0
Reserved		RELOAD	

Table 4.34. LOAD register bit assignments

Bits	Name	Function
[31:24]	-	Reserved.
[23:0]	RELOAD	Value to load into the VAL register when the counter is enabled and when it reaches 0, see Section 4.4.2.1 (p. 112) .

4.4.2.1 Calculating the RELOAD value

The RELOAD value can be any value in the range 0x00000001-0x00FFFFFF. A start value of 0 is possible, but has no effect because the SysTick exception request and COUNTFLAG are activated when counting from 1 to 0.

The RELOAD value is calculated according to its use:

- To generate a multi-shot timer with a period of N processor clock cycles, use a RELOAD value of N-1. For example, if the SysTick interrupt is required every 100 clock pulses, set RELOAD to 99.
- To deliver a single SysTick interrupt after a delay of N processor clock cycles, use a RELOAD of value N. For example, if a SysTick interrupt is required after 400 clock pulses, set RELOAD to 400.

4.4.3 SysTick Current Value Register

The VAL register contains the current value of the SysTick counter. See the register summary in Table 4.32 (p. 111) for its attributes. The bit assignments are:

31	24	23	0
Reserved		CURRENT	

Table 4.35. VAL register bit assignments

Bits	Name	Function
[31:24]	-	Reserved.
[23:0]	CURRENT	Reads return the current value of the SysTick counter. A write of any value clears the field to 0, and also clears the SysTick CTRL.COUNTFLAG bit to 0.

4.4.4 SysTick Calibration Value Register

The CALIB register indicates the SysTick calibration properties and is a read only register. See the register summary in Table 4.32 (p. 111) for its attributes. The bit assignments are:

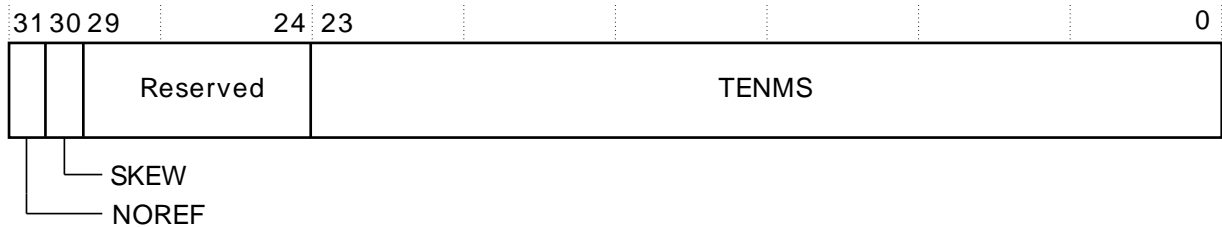

Table 4.36. CALIB register bit assignments

Bits	Name	Function
[31]	NOREF	Reads as zero. Indicates that the RTC counter bit 0 is provided as a reference clock.
[30]	SKEW	Reads as one. Calibration value for the 10ms inexact timing is not known because TENMS is not known. This can affect the suitability of SysTick as a software real time clock.
[29:24]	-	Reserved.
[23:0]	TENMS	Read as 0x0036B0, which gives 10 ms ticks when running off a 14 MHz clock.

If calibration information is not known, calculate the calibration value required from the frequency of the processor clock or external clock.

4.4.5 SysTick design hints and tips

The SysTick counter runs on the processor clock or bit 0 of the RTC counter value. If the clock signal in use is stopped (e.g. in lower Energy Modes), the SysTick counter stops.

Ensure software uses aligned word accesses to access the SysTick registers.

4.5 Memory protection unit

This section describes the *Memory protection unit* (MPU).

The MPU divides the memory map into a number of regions, and defines the location, size, access permissions, and memory attributes of each region. It supports:

- independent attribute settings for each region
- overlapping regions
- export of memory attributes to the system.

The memory attributes affect the behavior of memory accesses to the region. The Cortex-M3 MPU defines:

- eight separate memory regions, 0-7
- a background region.

When memory regions overlap, a memory access is affected by the attributes of the region with the highest number. For example, the attributes for region 7 take precedence over the attributes of any region that overlaps region 7.

The background region has the same memory access attributes as the default memory map, but is accessible from privileged software only.

The Cortex-M3 MPU memory map is unified. This means instruction accesses and data accesses have same region settings.

If a program accesses a memory location that is prohibited by the MPU, the processor generates a memory management fault. This causes a fault exception, and might cause termination of the process in an OS environment. In an OS environment, the kernel can update the MPU region setting dynamically based on the process to be executed. Typically, an embedded OS uses the MPU for memory protection.

Configuration of MPU regions is based on memory types, see Section 2.2.1 (p. 15) .

Table 4.37 (p. 114) shows the possible MPU region attributes. Please note that the Shareability and cache behavior attributes are usually not relevant for the EFM32 devices since these are not used by other bus masters. However, these can be useful together with the DMA Controller. See Section 4.5.9.1 (p. 123) for guidelines on using these attributes.

Table 4.37. Memory attributes summary

Memory type	Shareability	Other attributes	Description
Strongly-ordered	-	-	All accesses to Strongly-ordered memory occur in program order. All Strongly-ordered regions are assumed to be shared.
Device	Shared	-	Memory-mapped peripherals that several processors share.
	Non-shared	-	Memory-mapped peripherals that only a single processor uses.
Normal	Shared	Non-cacheable Write-through Cacheable Write-back Cacheable	Normal memory that is shared between several processors.
	Non-shared	Non-cacheable Write-through Cacheable Write-back Cacheable	Normal memory that only a single processor uses.

Use the MPU registers to define the MPU regions and their attributes. The MPU registers are:

Table 4.38. MPU registers summary

Address	Name	Type	Required privilege	Reset value	Description
0xE000ED90	TYPE	RO	Privileged	0x00000800	Section 4.5.1 (p. 114)
0xE000ED94	CTRL	RW	Privileged	0x00000000	Section 4.5.2 (p. 115)
0xE000ED98	RNR	RW	Privileged	0x00000000	Section 4.5.3 (p. 116)
0xE000ED9C	RBAR	RW	Privileged	0x00000000	Section 4.5.4 (p. 117)
0xE000EDA0	RASR	RW	Privileged	0x00000000	Section 4.5.5 (p. 117)
0xE000EDA4	RBAR_A1	RW	Privileged	0x00000000	Alias of RBAR, see Section 4.5.4 (p. 117)
0xE000EDA8	RASR_A1	RW	Privileged	0x00000000	Alias of RASR, see Section 4.5.5 (p. 117)
0xE000EDAC	RBAR_A2	RW	Privileged	0x00000000	Alias of RBAR, see Section 4.5.4 (p. 117)
0xE000EDB0	RASR_A2	RW	Privileged	0x00000000	Alias of RASR, see Section 4.5.5 (p. 117)
0xE000EDB4	RBAR_A3	RW	Privileged	0x00000000	Alias of RBAR, see Section 4.5.4 (p. 117)
0xE000EDB8	RASR_A3	RW	Privileged	0x00000000	Alias of RASR, see Section 4.5.5 (p. 117)

4.5.1 MPU Type Register

The TYPE register indicates how many regions the MPU supports. See the register summary in Table 4.38 (p. 114) for its attributes. The bit assignments are:

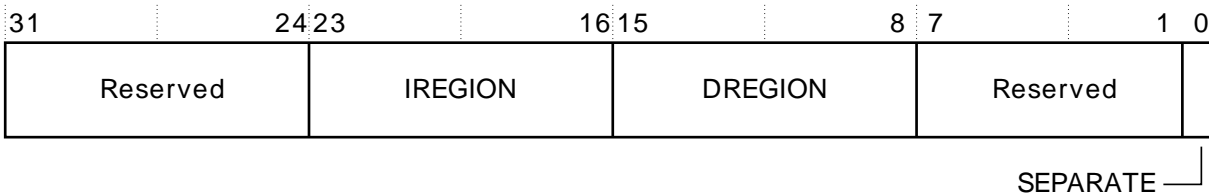

Table 4.39. TYPE register bit assignments

Bits	Name	Function
[31:24]	-	Reserved.
[23:16]	IREGION	Indicates the number of supported MPU instruction regions. Always contains 0x00. The MPU memory map is unified and is described by the DREGION field.
[15:8]	DREGION	Indicates the number of supported MPU data regions: 0x08 = Eight MPU regions.
[7:0]	-	Reserved.
[0]	SEPARATE	Indicates support for unified or separate instruction and data memory maps: 0 = unified.

4.5.2 MPU Control Register

The MPU CTRL register:

- enables the MPU
- enables the default memory map background region
- enables use of the MPU when in the hard fault, *Non-maskable Interrupt* (NMI), and FAULTMASK escalated handlers.

See the register summary in Table 4.38 (p. 114) for the MPU CTRL attributes. The bit assignments are:

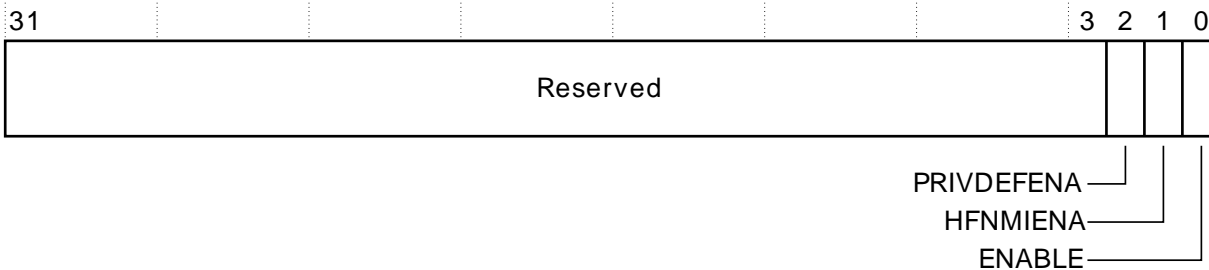

Table 4.40. MPU CTRL register bit assignments

Bits	Name	Function
[31:3]	-	Reserved.
[2]	PRIVDEFENA	Enables privileged software access to the default memory map: 0 = If the MPU is enabled, disables use of the default memory map. Any memory access to a location not covered by any enabled region causes a fault. 1 = If the MPU is enabled, enables use of the default memory map as a background region for privileged software accesses. When enabled, the background region acts as if it is region number -1. Any region that is defined and enabled has priority over this default map. If the MPU is disabled, the processor ignores this bit.
[1]	HFNMIENA	Enables the operation of MPU during hard fault, NMI, and FAULTMASK handlers. When the MPU is enabled:

Bits	Name	Function
		0 = MPU is disabled during hard fault, NMI, and FAULTMASK handlers, regardless of the value of the ENABLE bit 1 = the MPU is enabled during hard fault, NMI, and FAULTMASK handlers. When the MPU is disabled, if this bit is set to 1 the behavior is Unpredictable.
[0]	ENABLE	Enables the MPU: 0 = MPU disabled 1 = MPU enabled.

When ENABLE and PRIVDEFENA are both set to 1:

- For privileged accesses, the *default memory map* is as described in Section 2.2 (p. 14) . Any access by privileged software that does not address an enabled memory region behaves as defined by the default memory map.
- Any access by unprivileged software that does not address an enabled memory region causes a memory management fault.

XN and Strongly-ordered rules always apply to the System Control Space regardless of the value of the ENABLE bit.

When the ENABLE bit is set to 1, at least one region of the memory map must be enabled for the system to function unless the PRIVDEFENA bit is set to 1. If the PRIVDEFENA bit is set to 1 and no regions are enabled, then only privileged software can operate.

When the ENABLE bit is set to 0, the system uses the default memory map. This has the same memory attributes as if the MPU is not implemented, see Table 2.11 (p. 16) . The default memory map applies to accesses from both privileged and unprivileged software.

When the MPU is enabled, accesses to the System Control Space and vector table are always permitted. Other areas are accessible based on regions and whether PRIVDEFENA is set to 1.

Unless HFNMIENA is set to 1, the MPU is not enabled when the processor is executing the handler for an exception with priority –1 or –2. These priorities are only possible when handling a hard fault or NMI exception, or when FAULTMASK is enabled. Setting the HFNMIENA bit to 1 enables the MPU when operating with these two priorities.

4.5.3 MPU Region Number Register

The RNR selects which memory region is referenced by the RBAR and RASR registers. See the register summary in Table 4.38 (p. 114) for its attributes. The bit assignments are:

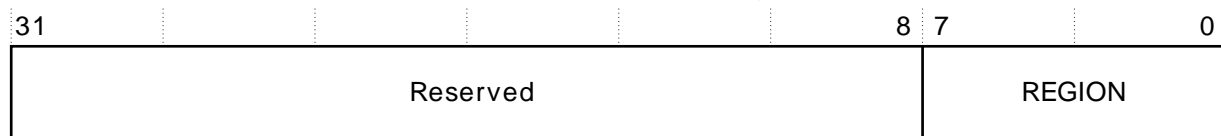

Table 4.41. RNR bit assignments

Bits	Name	Function
[31:8]	-	Reserved.
[7:0]	REGION	Indicates the MPU region referenced by the RBAR and RASR registers. The MPU supports 8 memory regions, so the permitted values of this field are 0-7.

Normally, you write the required region number to this register before accessing the RBAR or RASR. However you can change the region number by writing to the RBAR with the VALID bit set to 1, see Section 4.5.4 (p. 117) . This write updates the value of the REGION field.

4.5.4 MPU Region Base Address Register

The RBAR defines the base address of the MPU region selected by the RNR, and can update the value of the RNR. See the register summary in Table 4.38 (p. 114) for its attributes.

Write RBAR with the VALID bit set to 1 to change the current region number and update the RNR. The bit assignments are:

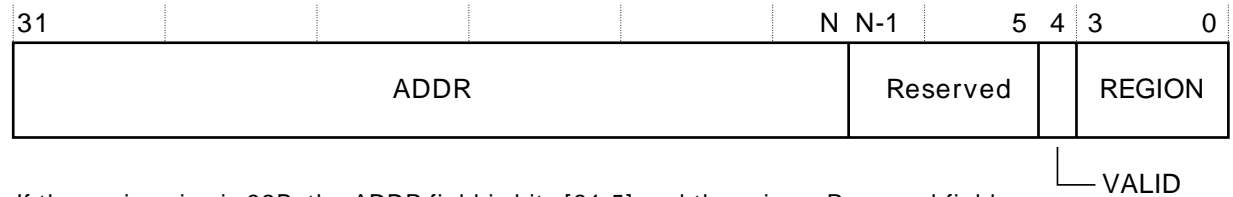

If the region size is 32B, the ADDR field is bits [31:5] and there is no Reserved field

Table 4.42. RBAR bit assignments

Bits	Name	Function
[31:N]	ADDR	Region base address field. The value of N depends on the region size. For more information see Section 4.5.4.1 (p. 117) .
[(N-1):5]	-	Reserved.
[4]	VALID	MPU Region Number valid bit: Write: 0 = RNR not changed, and the processor: <ul style="list-style-type: none"> • updates the base address for the region specified in the RNR • ignores the value of the REGION field 1 = the processor: <ul style="list-style-type: none"> • updates the value of the RNR to the value of the REGION field • updates the base address for the region specified in the REGION field. Always reads as zero.
[3:0]	REGION	MPU region field: For the behavior on writes, see the description of the VALID field. On reads, returns the current region number, as specified by the RNR.

4.5.4.1 The ADDR field

The ADDR field is bits[31:N] of the RBAR. The region size, as specified by the SIZE field in the RASR, defines the value of N:

$$N = \text{Log}_2(\text{Region size in bytes}),$$

If the region size is configured to 4GB, in the RASR, there is no valid ADDR field. In this case, the region occupies the complete memory map, and the base address is 0x00000000.

The base address is aligned to the size of the region. For example, a 64KB region must be aligned on a multiple of 64KB, for example, at 0x00010000 or 0x00020000.

4.5.5 MPU Region Attribute and Size Register

The RASR defines the region size and memory attributes of the MPU region specified by the RNR, and enables that region and any subregions. See the register summary in Table 4.38 (p. 114) for its attributes.

RASR is accessible using word or halfword accesses:

- the most significant halfword holds the region attributes
- the least significant halfword holds the region size and the region and subregion enable bits.

The bit assignments are:

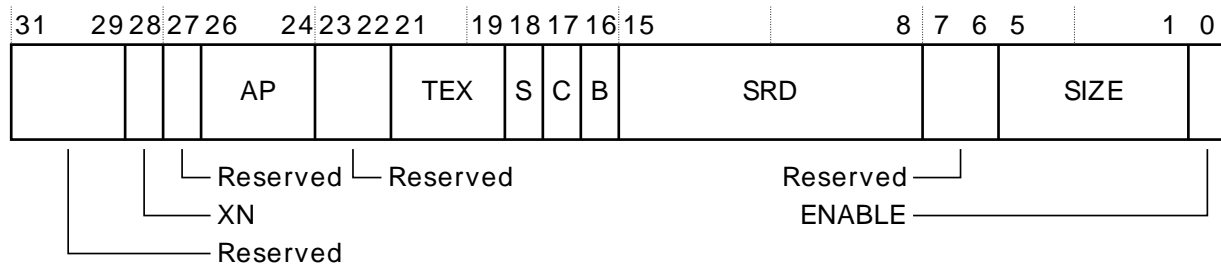

Table 4.43. RASR bit assignments

Bits	Name	Function
[31:29]	-	Reserved.
[28]	XN	Instruction access disable bit: 0 = instruction fetches enabled 1 = instruction fetches disabled.
[27]	-	Reserved.
[26:24]	AP	Access permission field, see Table 4.47 (p. 120) .
[23:22]	-	Reserved.
[21:19, 17, 16]	TEX, C, B	Memory access attributes, see Table 4.45 (p. 119) .
[18]	S	Shareable bit, see Table 4.45 (p. 119) .
[15:8]	SRD	Subregion disable bits. For each bit in this field: 0 = corresponding sub-region is enabled 1 = corresponding sub-region is disabled See Section 4.5.8.3 (p. 122) for more information. Region sizes of 128 bytes and less do not support subregions. When writing the attributes for such a region, write the SRD field as 0x00.
[7:6]	-	Reserved.
[5:1]	SIZE	Specifies the size of the MPU protection region. The minimum permitted value is 3 (b00010), see Section 4.5.5.1 (p. 118) for more information.
[0]	ENABLE	Region enable bit.

For information about access permission, see Section 4.5.6 (p. 119) .

4.5.5.1 SIZE field values

The SIZE field defines the size of the MPU memory region specified by the RNR. as follows:

$$(\text{Region size in bytes}) = 2^{(\text{SIZE}+1)}$$

The smallest permitted region size is 32B, corresponding to a SIZE value of 4. Table 4.44 (p. 118) gives example SIZE values, with the corresponding region size and value of N in the RBAR.

Table 4.44. Example SIZE field values

SIZE value	Region size	Value of N ¹	Note
b00100 (4)	32B	5	Minimum permitted size

SIZE value	Region size	Value of N ¹	Note
b01001 (9)	1KB	10	-
b10011 (19)	1MB	20	-
b11101 (29)	1GB	30	-
b11111 (31)	4GB	b01100	Maximum possible size

¹In the RBAR, see Section 4.5.4 (p. 117) .

4.5.6 MPU access permission attributes

This section describes the MPU access permission attributes. The access permission bits, TEX, C, B, S, AP, and XN, of the RASR, control access to the corresponding memory region. If an access is made to an area of memory without the required permissions, then the MPU generates a permission fault.

Table 4.45 (p. 119) shows the encodings for the TEX, C, B, and S access permission bits.

Table 4.45. TEX, C, B, and S encoding

TEX	C	B	S	Memory type	Shareability	Other attributes
b000	0	0	x ¹	Strongly-ordered	Shareable	-
			1	Device	Shareable	-
	1	0	0	Normal	Not shareable	Outer and inner write-through. No write allocate.
			1		Shareable	
b001	0	0	0	Normal	Not shareable	Outer and inner noncacheable.
			1		Shareable	
	1	0	x ¹	Reserved encoding		-
			1	x ¹	Implementation defined attributes.	
b010	0	0	x ¹	Device	Not shareable	Nonshared Device.
			1	x ¹	Reserved encoding	
	1	x ¹	x ¹	Reserved encoding		-
			0	Normal	Not shareable	Outer and inner write-back. Write and read allocate.
b1BB	A	A	0	Normal	Not shareable	Cached memory ² , BB = outer policy, AA = inner policy.
			1		Shareable	

¹The MPU ignores the value of this bit.

²See Table 4.46 (p. 119) for the encoding of the AA and BB bits.

Table 4.46 (p. 119) shows the cache policy for memory attribute encodings with a TEX value is in the range 4-7.

Table 4.46. Cache policy for memory attribute encoding

Encoding, AA or BB	Corresponding cache policy
00	Non-cacheable
01	Write back, write and read allocate
10	Write through, no write allocate
11	Write back, no write allocate

Table 4.47 (p. 120) shows the AP encodings that define the access permissions for privileged and unprivileged software.

Table 4.47. AP encoding

AP[2:0]	Privileged permissions	Unprivileged permissions	Description
000	No access	No access	All accesses generate a permission fault
001	RW	No access	Access from privileged software only
010	RW	RO	Writes by unprivileged software generate a permission fault
011	RW	RW	Full access
100	Unpredictable	Unpredictable	Reserved
101	RO	No access	Reads by privileged software only
110	RO	RO	Read only, by privileged or unprivileged software
111	RO	RO	Read only, by privileged or unprivileged software

4.5.7 MPU mismatch

When an access violates the MPU permissions, the processor generates a memory management fault, see Section 2.1.4 (p. 13). The MMFSR indicates the cause of the fault. See Section 4.3.11.1 (p. 105) for more information.

4.5.8 Updating an MPU region

To update the attributes for an MPU region, update the RNR, RBAR and RASR registers. You can program each register separately, or use a multiple-word write to program all of these registers. You can use the RBAR and RASR aliases to program up to four regions simultaneously using an STM instruction.

4.5.8.1 Updating an MPU region using separate words

Simple code to configure one region:

```

; R1 = region number

; R2 = size/enable

; R3 = attributes

; R4 = address

LDR R0,=MPU_RNR           ; 0xE000ED98, MPU region number register

STR R1, [R0, #0x0]       ; Region Number

STR R4, [R0, #0x4]       ; Region Base Address

STRH R2, [R0, #0x8]      ; Region Size and Enable

STRH R3, [R0, #0xA]      ; Region Attribute

```

Disable a region before writing new region settings to the MPU if you have previously enabled the region being changed. For example:

```

; R1 = region number

; R2 = size/enable

; R3 = attributes

; R4 = address

LDR R0,=MPU_RNR          ; 0xE000ED98, MPU region number register

STR R1, [R0, #0x0]      ; Region Number

BIC R2, R2, #1          ; Disable

STRH R2, [R0, #0x8]     ; Region Size and Enable

STR R4, [R0, #0x4]      ; Region Base Address

STRH R3, [R0, #0xA]     ; Region Attribute

ORR R2, #1              ; Enable

STRH R2, [R0, #0x8]     ; Region Size and Enable

```

Software must use memory barrier instructions:

- before MPU setup if there might be outstanding memory transfers, such as buffered writes, that might be affected by the change in MPU settings
- after MPU setup if it includes memory transfers that must use the new MPU settings.

However, memory barrier instructions are not required if the MPU setup process starts by entering an exception handler, or is followed by an exception return, because the exception entry and exception return mechanism cause memory barrier behavior.

Software does not need any memory barrier instructions during MPU setup, because it accesses the MPU through the PPB, which is a Strongly-Ordered memory region.

For example, if you want all of the memory access behavior to take effect immediately after the programming sequence, use a DSB instruction and an ISB instruction. A DSB is required after changing MPU settings, such as at the end of context switch. An ISB is required if the code that programs the MPU region or regions is entered using a branch or call. If the programming sequence is entered using a return from exception, or by taking an exception, then you do not require an ISB.

4.5.8.2 Updating an MPU region using multi-word writes

You can program directly using multi-word writes, depending on how the information is divided. Consider the following reprogramming:

```

; R1 = region number

; R2 = address

```

```

; R3 = size, attributes in one

LDR R0, =MPU_RNR      ; 0xE000ED98, MPU region number register

STR R1, [R0, #0x0]   ; Region Number

STR R2, [R0, #0x4]   ; Region Base Address

STR R3, [R0, #0x8]   ; Region Attribute, Size and Enable

```

Use an STM instruction to optimize this:

```

; R1 = region number

; R2 = address

; R3 = size, attributes in one

LDR R0, =MPU_RNR      ; 0xE000ED98, MPU region number register

STM R0, {R1-R3}       ; Region Number, address, attribute, size and enable

```

You can do this in two words for pre-packed information. This means that the RBAR contains the required region number and had the VALID bit set to 1, see Section 4.5.4 (p. 117) . Use this when the data is statically packed, for example in a boot loader:

```

; R1 = address and region number in one

; R2 = size and attributes in one

LDR R0, =MPU_RBAR     ; 0xE000ED9C, MPU Region Base register

STR R1, [R0, #0x0]   ; Region base address and
; region number combined with VALID (bit 4) set to 1

STR R2, [R0, #0x4]   ; Region Attribute, Size and Enable

```

Use an STM instruction to optimize this:

```

; R1 = address and region number in one

; R2 = size and attributes in one

LDR R0, =MPU_RBAR     ; 0xE000ED9C, MPU Region Base register

STM R0, {R1-R2}       ; Region base address, region number and VALID bit,
; and Region Attribute, Size and Enable

```

4.5.8.3 Subregions

Regions of 256 bytes or more are divided into eight equal-sized subregions. Set the corresponding bit in the SRD field of the RASR to disable a subregion, see Section 4.5.5 (p. 117) . The least significant

bit of SRD controls the first subregion, and the most significant bit controls the last subregion. Disabling a subregion means another region overlapping the disabled range matches instead. If no other enabled region overlaps the disabled subregion the MPU issues a fault.

Regions of 32, 64, and 128 bytes do not support subregions, With regions of these sizes, you must set the SRD field to 0x00, otherwise the MPU behavior is Unpredictable.

4.5.8.3.1 Example of SRD use

Two regions with the same base address overlap. Region one is 128KB, and region two is 512KB. To ensure the attributes from region one apply to the first 128KB region, set the SRD field for region two to b00000011 to disable the first two subregions, as the figure shows.

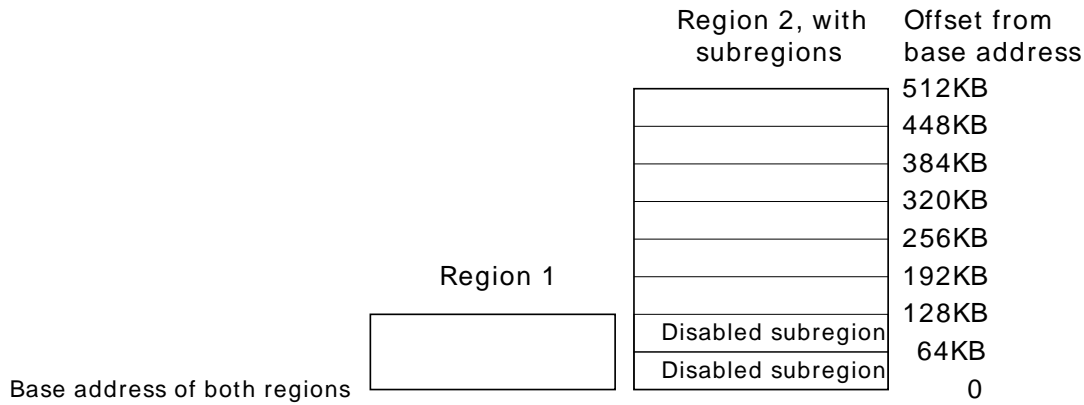

4.5.9 MPU design hints and tips

To avoid unexpected behavior, disable the interrupts before updating the attributes of a region that the interrupt handlers might access.

Ensure software uses aligned accesses of the correct size to access MPU registers:

- except for the RASR, it must use aligned word accesses
- for the RASR it can use byte or aligned halfword or word accesses.

The processor does not support unaligned accesses to MPU registers.

When setting up the MPU, and if the MPU has previously been programmed, disable unused regions to prevent any previous region settings from affecting the new MPU setup.

4.5.9.1 MPU configuration for a microcontroller

The EFM32 devices has only a single processor and information on Shareability and cache behavior is not used. In such a system, program the MPU as follows:

Table 4.48. Memory region attributes for a microcontroller

Memory region	TEX	C	B	S	Memory type and attributes
Flash memory	b000	1	0	0	Normal memory, Non-shareable, write-through
Internal SRAM	b000	1	0	1	Normal memory, Shareable, write-through
External SRAM	b000	1	1	1	Normal memory, Shareable, write-back, write-allocate
Peripherals	b000	0	1	1	Device memory, Shareable

In the EFM32 devices the shareability and cache policy attributes do not affect the system behavior. However, using these settings for the MPU regions can make the application code more portable and also be useful for setups with the DMA Controller. The values given are for typical situations.

Glossary

This glossary describes some of the terms used in technical documents from ARM.

Abort	A mechanism that indicates to a processor that the value associated with a memory access is invalid. An abort can be caused by the external or internal memory system as a result of attempting to access invalid instruction or data memory.
Aligned	A data item stored at an address that is divisible by the number of bytes that defines the data size is said to be aligned. Aligned words and halfwords have addresses that are divisible by four and two respectively. The terms word-aligned and halfword-aligned therefore stipulate addresses that are divisible by four and two respectively.
Banked register	A register that has multiple physical copies, where the state of the processor determines which copy is used. The Stack Pointer, SP (R13) is a banked register.
Base register	In instruction descriptions, a register specified by a load or store instruction that is used to hold the base value for the instruction's address calculation. Depending on the instruction and its addressing mode, an offset can be added to or subtracted from the base register value to form the address that is sent to memory. See Also Index register.
Big-endian (BE)	Byte ordering scheme in which bytes of decreasing significance in a data word are stored at increasing addresses in memory. See Also Byte-invariant, Endianness, Little-endian.
Big-endian memory	Memory in which: <ul style="list-style-type: none">• a byte or halfword at a word-aligned address is the most significant byte or halfword within the word at that address• a byte at a halfword-aligned address is the most significant byte within the halfword at that address. See Also Little-endian memory.
Breakpoint	A breakpoint is a mechanism provided by debuggers to identify an instruction at which program execution is to be halted. Breakpoints are inserted by the programmer to enable inspection of register contents, memory locations, variable values at fixed points in the program execution to test that the program is operating correctly. Breakpoints are removed after the program is successfully tested.
Byte-invariant	In a byte-invariant system, the address of each byte of memory remains unchanged when switching between little-endian and big-endian operation. When a data item larger than a byte is loaded from or stored to memory, the bytes making up that data item are arranged into the correct order depending on the endianness of the memory access. An ARM byte-invariant implementation also supports unaligned halfword and word memory accesses. It expects multi-word accesses to be word-aligned.
Cache	A block of on-chip or off-chip fast access memory locations, situated between the processor and main memory, used for storing and retrieving copies of often used instructions, data, or instructions and data. This is done to greatly

	increase the average speed of memory accesses and so improve processor performance.
Condition field	A four-bit field in an instruction that specifies a condition under which the instruction can execute.
Conditional execution	If the condition code flags indicate that the corresponding condition is true when the instruction starts executing, it executes normally. Otherwise, the instruction does nothing.
Context	The environment that each process operates in for a multitasking operating system. In ARM processors, this is limited to mean the physical address range that it can access in memory and the associated memory access permissions.
Coprocessor	A processor that supplements the main processor. Cortex-M3 does not support any coprocessors.
Debugger	A debugging system that includes a program, used to detect, locate, and correct software faults, together with custom hardware that supports software debugging.
Direct Memory Access (DMA)	An operation that accesses main memory directly, without the processor performing any accesses to the data concerned.
Doubleword	A 64-bit data item. The contents are taken as being an unsigned integer unless otherwise stated.
Doubleword-aligned	A data item having a memory address that is divisible by eight.
Endianness	Byte ordering. The scheme that determines the order that successive bytes of a data word are stored in memory. An aspect of the system's memory mapping. See Also Little-endian and Big-endian.
Exception	<p>An event that interrupts program execution. When an exception occurs, the processor suspends the normal program flow and starts execution at the address indicated by the corresponding exception vector. The indicated address contains the first instruction of the handler for the exception.</p> <p>An exception can be an interrupt request, a fault, or a software-generated system exception. Faults include attempting an invalid memory access, attempting to execute an instruction in an invalid processor state, and attempting to execute an undefined instruction.</p>
Exception service routine	See Interrupt handler.
Exception vector	See Interrupt vector.
Flat address mapping	A system of organizing memory in which each physical address in the memory space is the same as the corresponding virtual address.
Halfword	A 16-bit data item.
Illegal instruction	An instruction that is architecturally Undefined.
Implementation-defined	The behavior is not architecturally defined, but is defined and documented by individual implementations.

Implementation-specific	The behavior is not architecturally defined, and does not have to be documented by individual implementations. Used when there are a number of implementation options available and the option chosen does not affect software compatibility.
Index register	In some load and store instruction descriptions, the value of this register is used as an offset to be added to or subtracted from the base register value to form the address that is sent to memory. Some addressing modes optionally enable the index register value to be shifted prior to the addition or subtraction. See Also Base register.
Instruction cycle count	The number of cycles that an instruction occupies the Execute stage of the pipeline.
Interrupt handler	A program that control of the processor is passed to when an interrupt occurs.
Interrupt vector	One of a number of fixed addresses in low memory, or in high memory if high vectors are configured, that contains the first instruction of the corresponding interrupt handler.
Little-endian (LE)	Byte ordering scheme in which bytes of increasing significance in a data word are stored at increasing addresses in memory. See Also Big-endian, Byte-invariant, Endianness.
Little-endian memory	Memory in which: <ul style="list-style-type: none"> • a byte or halfword at a word-aligned address is the least significant byte or halfword within the word at that address • a byte at a halfword-aligned address is the least significant byte within the halfword at that address. <p>See Also Big-endian memory.</p>
Load/store architecture	A processor architecture where data-processing operations only operate on register contents, not directly on memory contents.
Memory Protection Unit (MPU)	Hardware that controls access permissions to blocks of memory. An MPU does not perform any address translation.
Prefetching	In pipelined processors, the process of fetching instructions from memory to fill up the pipeline before the preceding instructions have finished executing. Prefetching an instruction does not mean that the instruction has to be executed.
Read	Reads are defined as memory operations that have the semantics of a load. Reads include the Thumb instructions LDM, LDR, LDRSH, LDRH, LDRSB, LDRB, and POP.
Region	A partition of memory space.
Reserved	A field in a control register or instruction format is reserved if the field is to be defined by the implementation, or produces Unpredictable results if the contents of the field are not zero. These fields are reserved for use in future extensions of the architecture or are implementation#specific. All reserved bits not used by the implementation must be written as 0 and read as 0.
Should Be One (SBO)	Write as 1, or all 1s for bit fields, by software. Writing as 0 produces Unpredictable results.

Should Be Zero (SBZ)	Write as 0, or all 0s for bit fields, by software. Writing as 1 produces Unpredictable results.
Should Be Zero or Preserved (SBZP)	Write as 0, or all 0s for bit fields, by software, or preserved by writing the same value back that has been previously read from the same field on the same processor.
Thread-safe	In a multi-tasking environment, thread-safe functions use safeguard mechanisms when accessing shared resources, to ensure correct operation without the risk of shared access conflicts.
Thumb instruction	One or two halfwords that specify an operation for a processor to perform. Thumb instructions must be halfword-aligned.
Unaligned	A data item stored at an address that is not divisible by the number of bytes that defines the data size is said to be unaligned. For example, a word stored at an address that is not divisible by four.
Undefined	Indicates an instruction that generates an Undefined instruction exception.
Unpredictable (UNP)	You cannot rely on the behavior. Unpredictable behavior must not represent security holes. Unpredictable behavior must not halt or hang the processor, or any parts of the system.
Warm reset	Also known as a core reset. Initializes the majority of the processor excluding the debug controller and debug logic. This type of reset is useful if you are using the debugging features of a processor.
WA	See Write-allocate.
WB	See Write-back.
Word	A 32-bit data item.
Write	Writes are defined as operations that have the semantics of a store. Writes include the Thumb instructions <code>STM</code> , <code>STR</code> , <code>STRH</code> , <code>STRB</code> , and <code>PUSH</code> .
Write-allocate (WA)	In a write-allocate cache, a cache miss on storing data causes a cache line to be allocated into the cache.
Write-back (WB)	In a write-back cache, data is only written to main memory when it is forced out of the cache on line replacement following a cache miss. Otherwise, writes by the processor only update the cache. This is also known as copyback.
Write buffer	A block of high-speed memory, arranged as a FIFO buffer, between the data cache and main memory, whose purpose is to optimize stores to main memory.
Write-through (WT)	In a write-through cache, data is written to main memory at the same time as the cache is updated.

5 Revision History

5.1 Revision 1.00

February 4th, 2011

Updated document to reflect all EFM32 ARM Cortex-M3 devices.

Added information on differences between EFM32G, EFM32GG and EFM32TG devices.

5.2 Revision 0.81

December 9th, 2009

Corrected intrinsic function for Wait For Interrupt in 2.5.4

Added description of all PRIGROUP settings in Table 4-18

5.3 Revision 0.80

Initial preliminary revision, October 19th, 2009

A Disclaimer and Trademarks

A.1 Disclaimer

Energy Micro AS intends to provide customers with the latest, accurate, and in-depth documentation of all peripherals and modules available for system and software implementers using or intending to use the Energy Micro products. Characterization data, available modules and peripherals, memory sizes and memory addresses refer to each specific device, and "Typical" parameters provided can and do vary in different applications. Application examples described herein are for illustrative purposes only. Energy Micro reserves the right to make changes without further notice and limitation to product information, specifications, and descriptions herein, and does not give warranties as to the accuracy or completeness of the included information. Energy Micro shall have no liability for the consequences of use of the information supplied herein. This document does not imply or express copyright licenses granted hereunder to design or fabricate any integrated circuits. The products must not be used within any Life Support System without the specific written consent of Energy Micro. A "Life Support System" is any product or system intended to support or sustain life and/or health, which, if it fails, can be reasonably expected to result in significant personal injury or death. Energy Micro products are generally not intended for military applications. Energy Micro products shall under no circumstances be used in weapons of mass destruction including (but not limited to) nuclear, biological or chemical weapons, or missiles capable of delivering such weapons.

A.2 Trademark Information

Energy Micro, EFM32, EFR, logo and combinations thereof, and others are the registered trademarks or trademarks of Energy Micro AS. ARM, CORTEX, THUMB are the registered trademarks of ARM Limited. Other terms and product names may be trademarks of others.

B Contact Information

B.1 Energy Micro Corporate Headquarters

Postal Address	Visitor Address	Technical Support
Energy Micro AS P.O. Box 4633 Nydalen N-0405 Oslo NORWAY	Energy Micro AS Sandakerveien 118 N-0484 Oslo NORWAY	support.energymicro.com Phone: +47 40 10 03 01

www.energymicro.com

Phone: +47 23 00 98 00

Fax: + 47 23 00 98 01

B.2 Global Contacts

Visit **www.energymicro.com** for information on global distributors and representatives or contact **sales@energymicro.com** for additional information.

Americas	Europe, Middle East and Africa	Asia and Pacific
www.energymicro.com/americas	www.energymicro.com/emea	www.energymicro.com/asia

Table of Contents

1. Introduction	2
1.1. About this document	2
1.2. About the EFM32 Cortex-M3 processor and core peripherals	2
2. The Cortex-M3 Processor	6
2.1. Programmers model	6
2.2. Memory model	14
2.3. Exception model	22
2.4. Fault handling	28
2.5. Power management	30
3. The Cortex-M3 Instruction Set	33
3.1. Instruction set summary	33
3.2. Intrinsic functions	37
3.3. About the instruction descriptions	38
3.4. Memory access instructions	45
3.5. General data processing instructions	56
3.6. Multiply and divide instructions	66
3.7. Saturating instructions	69
3.8. Bitfield instructions	71
3.9. Branch and control instructions	73
3.10. Miscellaneous instructions	79
4. The Cortex-M3 Peripherals	88
4.1. About the peripherals	88
4.2. Nested Vectored Interrupt Controller	88
4.3. System control block	94
4.4. System timer, SysTick	111
4.5. Memory protection unit	113
Glossary	124
5. Revision History	128
5.1. Revision 1.00	128
5.2. Revision 0.81	128
5.3. Revision 0.80	128
A. Disclaimer and Trademarks	129
A.1. Disclaimer	129
A.2. Trademark Information	129
B. Contact Information	130
B.1. Energy Micro Corporate Headquarters	130
B.2. Global Contacts	130

List of Figures

1.1. EFM32 Cortex-M3 implementation	3
2.1. Bit-band mapping	19
2.2. Vector table	25
3.1. ASR #3	40
3.2. LSR #3	41
3.3. LSL #3	41
3.4. ROR #3	42
3.5. RRX	42

List of Tables

1.1. Cortex-M3 configuration in EFM32 series	5
2.1. Summary of processor mode, execution privilege level, and stack use options	6
2.2. Core register set summary	7
2.3. PSR register combinations	9
2.4. APSR bit assignments	9
2.5. IPSR bit assignments	10
2.6. EPSR bit assignments	10
2.7. PRIMASK register bit assignments	11
2.8. FAULTMASK register bit assignments	12
2.9. BASEPRI register bit assignments	12
2.10. CONTROL register bit assignments	13
2.11. Memory access behavior	16
2.12. SRAM memory bit-banding regions	18
2.13. Peripheral memory bit-banding regions	18
2.14. C compiler intrinsic functions for exclusive access instructions	21
2.15. Properties of the different exception types	23
2.16. Exception return behavior	28
2.17. Faults	28
2.18. Fault status and fault address registers	30
3.1. Cortex-M3 instructions	33
3.2. CMSIS intrinsic functions to generate some Cortex-M3 instructions	37
3.3. CMSIS intrinsic functions to access the special registers	37
3.4. Condition code suffixes	44
3.5. Memory access instructions	45
3.6. Offset ranges	48
3.7. Offset ranges	51
3.8. Data processing instructions	56
3.9. Multiply and divide instructions	66
3.10. Packing and unpacking instructions	71
3.11. Branch and control instructions	73
3.12. Branch ranges	74
3.13. Miscellaneous instructions	79
4.1. Core peripheral register regions	88
4.2. NVIC register summary	88
4.3. Mapping of interrupts to the interrupt variables	89
4.4. ISER bit assignments	90
4.5. ICER bit assignments	90
4.6. ISPR bit assignments	91
4.7. ICPR bit assignments	91
4.8. IABR bit assignments	92
4.9. IPR bit assignments	92
4.10. STIR bit assignments	93
4.11. CMSIS functions for NVIC control	94
4.12. Summary of the system control block registers	94
4.13. ACTLR bit assignments	95
4.14. CPUID register bit assignments	96
4.15. ICSR bit assignments	97
4.16. VTOR bit assignments	99
4.17. AIRCR bit assignments	99
4.18. Priority grouping	100
4.19. SCR bit assignments	100
4.20. CCR bit assignments	101
4.21. System fault handler priority fields	102
4.22. SHPR1 register bit assignments	103
4.23. SHPR2 register bit assignments	103
4.24. SHPR3 register bit assignments	103
4.25. SHCSR bit assignments	104
4.26. MMFSR bit assignments	106
4.27. BFSR bit assignments	107
4.28. UFSR bit assignments	108
4.29. HFSR bit assignments	109
4.30. MMFAR bit assignments	110
4.31. BFAR bit assignments	110
4.32. System timer registers summary	111
4.33. SysTick CTRL register bit assignments	111
4.34. LOAD register bit assignments	112
4.35. VAL register bit assignments	112
4.36. CALIB register bit assignments	113
4.37. Memory attributes summary	114
4.38. MPU registers summary	114
4.39. TYPE register bit assignments	115

4.40. MPU CTRL register bit assignments	115
4.41. RNR bit assignments	116
4.42. RBAR bit assignments	117
4.43. RASR bit assignments	118
4.44. Example SIZE field values	118
4.45. TEX, C, B, and S encoding	119
4.46. Cache policy for memory attribute encoding	119
4.47. AP encoding	120
4.48. Memory region attributes for a microcontroller	123

List of Examples

3.1. Absolute value	44
3.2. Compare and update value	45
3.3. Instruction width selection	45
3.4. 64-bit addition	59
3.5. 96-bit subtraction	59

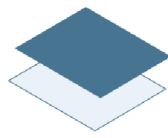

ENERGY[®]
micro

*Energy Micro AS
Sandakerveien 118
P.O. Box 4633 Nydalen
N-0405 Oslo
Norway*

www.energymicro.com