

**3mm  
LED CBI® Circuit Board Indicator  
Tri-Level**

**Dialight**  
**564-0x00-xxx**

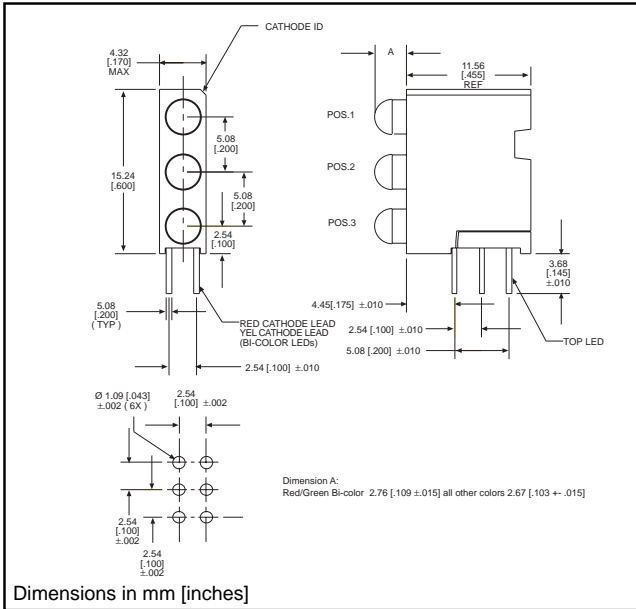

**Features**

- Multiple CBIs form horizontal LED arrays on 4.45mm (0.175") center-lines.
- High Contrast, UL 94 V-0 rated, black housing
- Oxygen index: 29%
- Polymer content: PBT, 0.078 g
- Housing stand-offs facilitate PCB cleaning
- Solderability per MIL-STD-202F, method 208F
- LEDs are safe for direct viewing per IEC 825-1, EN-60825-1

**Tolerance note: As noted, otherwise:**

- LED Protrusion:  $\pm 0.04$  mm [ $\pm 0.016$ ]
- CBI Housing:  $\pm 0.02$ mm [ $\pm 0.008$ ]

**Custom Combinations**

- Contact factory for information on custom color combinations

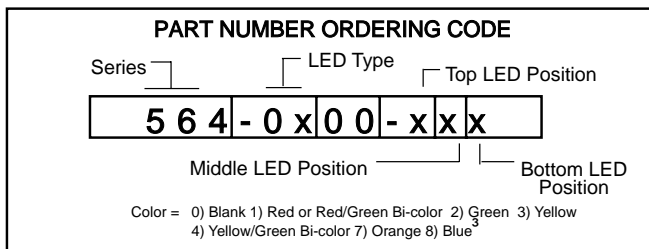

**PART NO.**

**COLOR\***

**HIGH EFFICIENCY - LED TYPE 01**

- 564-0100-111 Red-Red-Red
- 564-0100-132 Red-Yellow-Green
- 564-0100-222 Green-Green-Green
- 564-0100-777 Orange-Orange-Orange
- 564-0100-999 Blue-Blue-Blue



**LOW CURRENT - LED TYPE 02**

- 564-0200-111 Red-Red-Red
- 564-0200-132 Red-Yellow-Green
- 564-0200-222 Green-Green-Green

**INTEGRAL RESISTOR, 5 VOLTS - LED TYPE 03**

- 564-0300-111 Red-Red-Red
- 564-0300-132 Red-Yellow-Green
- 564-0300-222 Green-Green-Green



**BI-COLOR - LED TYPE 07**

- 564-0700-111 Red/Green-Red/Green-Red/Green
- 564-0700-444 Yellow/Green-Yellow/Green-Yellow/Green

\* Top-Middle-Bottom LED



**ATTENTION**  
OBSERVE PRECAUTIONS  
FOR HANDLING  
ELECTROSTATIC  
SENSITIVE  
DEVICES

# 564-0x00-xxx

## Typical Operating Characteristics ( $T_A=25^{\circ}\text{C}$ )

See LED data sheet for additional information  
See Pages 4-73 and 4-74 for LED Drive Circuit Examples  
See Page 4-72 for Pin Out

### HIGH EFFICIENCY

Part Number	Color	Peak Wavelength nm	$I_V$ mcd	$V_F$ Volts	Test Current (mA)	Viewing Angle $2\Theta_{\%}$	LED Data sheet	Page #
564-0100-xxx	Red	635	10	2*	10	60°	521-9216	4-58
	Green	565	12.6	2.1*	10	60°	521-9210	4-58
	Yellow	585	10	2.1*	10	60°	521-9211	4-58
	Orange	600	7	2.2	10	60°	521-9498	4-58
	Blue	428	12	3.5	10	70°	521-9831	4-57

\*  $I_F = 20\text{mA}$

### LOW CURRENT

Part Number	Color	Peak Wavelength nm	$I_V$ mcd	$V_F$ Volts	Test Current (mA)	Viewing Angle $2\Theta_{\%}$	LED Data sheet	Page #
564-0200-xxx	Red	635	1.6	1.7	2	60°	521-9324	4-60
	Green	565	1.6	1.9	2	60°	521-9326	4-60
	Yellow	585	1.6	1.8	2	60°	521-9325	4-60

### INTEGRAL RESISTOR, 5 VOLTS

Part Number	Color	Peak Wavelength nm	$I_V$ mcd	Test Voltage	Forward Current (mA)	Viewing Angle $2\Theta_{\%}$	LED Data sheet	Page #
564-0300-xxx	Red	635	29	5	10	60°	521-9215	4-59
	Green	565	19	5	10	60°	521-9323	4-59
	Yellow	585	12.6	5	10	60°	521-9322	4-59

### BI-COLOR

Part Number	Color	Peak Wavelength nm	$I_V$ mcd	$V_F$ Volts	Test Current (mA)	Viewing Angle $2\Theta_{\%}$	LED Data sheet	Page #
564-0700-111	Red/Green	635/565	4.7/10	2/2.1	10	50°	521-9459	4-63
564-0700-444	Yellow/Green	585/565	4.3/6.3	2.1*/2.1*	10	80°	521-9478	4-62

\*  $I_F = 20\text{mA}$





# 3mm Discrete LED Tinted, Diffused

# Dialight

## 521-9831

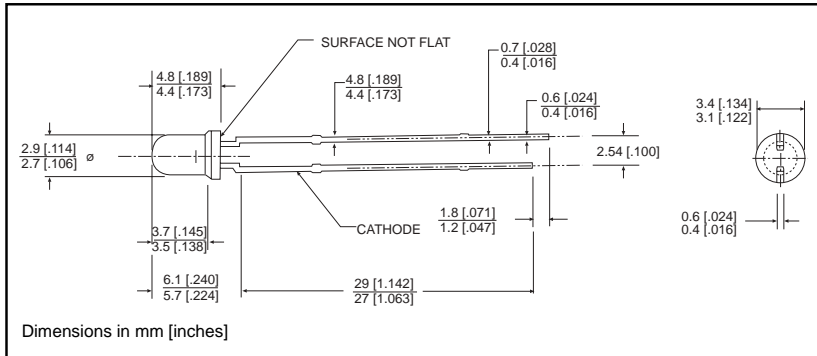

**PART NO.**

521-9831

**COLOR**

Blue<sup>3</sup>

**MOUNTING CLIP:** 515-0006

located on page 4-65



4

**ABSOLUTE MAXIMUM RATINGS** (T<sub>A</sub>=25°C)

Blue  
-9831

Power Dissipation (mW)	100
Forward Current (mA)	20
Derating (mA/°C) From 55°C	.44
Operating Temperature (°C)	-40/+100
Storage Temperature (°C)	-40/+100
Soldering Temperature	260°C, 5 seconds, 1.6 mm from case

Solder Adherence per MIL-STD-202E, Method 208C

**OPERATING CHARACTERISTICS** (T<sub>A</sub>=25°C)

Blue  
-9831

Luminous Intensity (mcd)	Min.	6.3
I <sub>F</sub> =10mA	Typical	12
Peak Wavelength (nm)	Typical	428
λ Peak		
Viewing Angle (2θ <sub>1/2</sub> )	Typical	70°
Forward Voltage (V)	Typical	3.5
I <sub>F</sub> =10mA	Max.	4.2
Reverse Voltage (V) I <sub>R</sub> =10μA	Min.	3

θ<sub>1/2</sub> is the off axis angle at which the luminous intensity is half the axial luminous intensity

# 3mm Discrete LED

High Efficiency

Diffused

521-9210, -9211, -9216, -9498, -9636

# Dialight

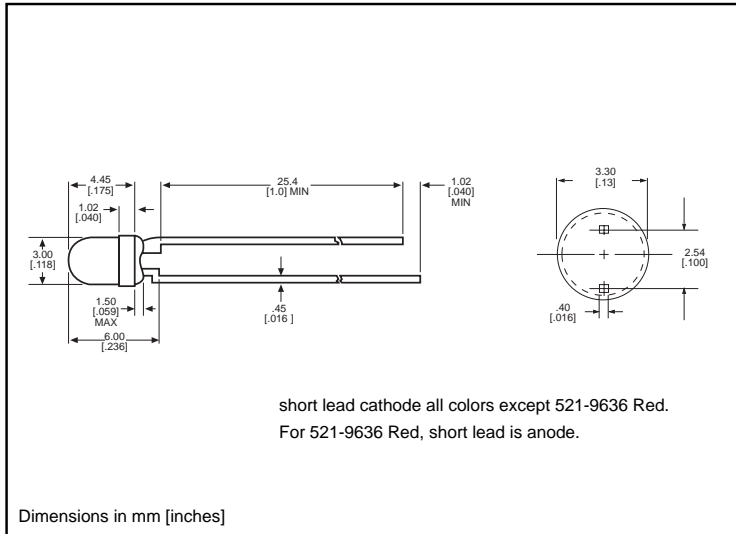

**PART NO. COLOR**

- 521-9210 Green
- 521-9211 Yellow
- 521-9216 Red
- 521-9498 Orange
- 521-9636 Red



**MOUNTING CLIP: 515-0006**  
located on page 4-65

<b>ABSOLUTE MAXIMUM RATINGS</b> ( $T_A=25^\circ\text{C}$ )	Green <b>-9210</b>	Yellow <b>-9211</b>	Red <b>-9216</b>	Orange <b>-9498</b>	Red <b>-9636</b>
Power Dissipation (mW)	100	60	100	135	100
Forward Current (mA)	30	20	30	25	40
Derating (mA/°C) From 50°C <sup>1</sup> from 25°C	.4	.25	.4	.5	.5 <sup>1</sup>
Operating Temperature (°C)	-55/+100	-55/+100	-55/+100	-55/+100	-55/+100
Storage Temperature (°C)	-55/+100	-55/+100	-55/+100	-55/+100	-55/+100
Soldering Temperature	260°C, 5 seconds, 1.6 mm from body				

Solder Adherence per MIL-STD-202E, Method 208C

<b>OPERATING CHARACTERISTICS</b> ( $T_A=25^\circ\text{C}$ )		Green <b>-9210</b>	Yellow <b>-9211</b>	Red <b>-9216</b>	Orange <b>-9498</b>	Red <b>-9636</b>
Luminous Intensity (mcd)	Min.	4.7	7.4	7.4	3.4	8.7 <sup>1</sup>
	Typical	12.6	10	10	7	48 <sup>1</sup>
Peak Wavelength (nm)	Typical	565	585	635	600	660
Viewing Angle ( $2\theta^{1/2}$ )	Typical	60°	60°	60°	60°	60°
Forward Voltage (V)	Typical	2.1 <sup>1</sup>	2.1 <sup>1</sup>	2 <sup>1</sup>	2.2	1.8 <sup>1</sup>
	Max.	2.8 <sup>1</sup>	2.8 <sup>1</sup>	2.8 <sup>1</sup>	3	2.4 <sup>1</sup>
Reverse Voltage (V), $I_R=100\mu\text{A}$	Max.	5	5	5	5	4

$\theta^{1/2}$  is the off axis angle at which the luminous intensity is half the axial luminous intensity

**3mm Discrete LED  
Integral Resistor, 5V  
Diffused**

**Dialight**

**521-9215, -9322, -9323**

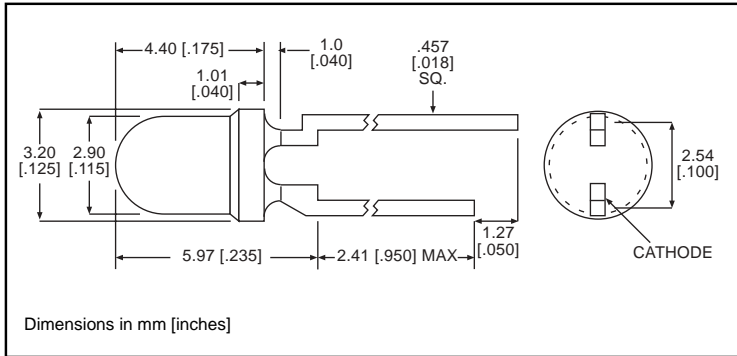

PART NO.	COLOR
521-9215	Red
521-9322	Yellow
521-9323	Green

**MOUNTING CLIP:** 515-0006  
located on page 4-65

**ABSOLUTE MAXIMUM RATINGS** ( $T_A=25^\circ\text{C}$ )

	Red -9215	Yellow -9322	Green -9323
Forward Voltage (V)	7.5	7.5	7.5
Derating (V/°C) From 50°C	.086	.086	.071
Operating Temperature (°C)	-40/+85	-40/+85	-20/+85
Storage Temperature (°C)	-55/+100	-55/+100	-55/+100
Soldering Temperature	260°C, 5 seconds, 1.6 mm from case		

Solder Adherence per MIL-STD-202E, Method 208C

**OPERATING CHARACTERISTICS** ( $T_A=25^\circ\text{C}$ )

		Red -9215	Yellow -9322	Green -9323
Luminous Intensity (mcd)	Min.	8.7	3.7	5.6
	Typical	29	12.6	19
Peak Wavelength (nm)	Typical	635	585	565
Viewing Angle ( $2\theta^{1/2}$ )	Typical	60°	60°	60°
Forward Current (mA)	Typical	10	10	10
	Max.	20	20	20
Reverse Voltage (V), $I_R=100\mu\text{A}$	Min.	5	5	5

$\theta^{1/2}$  is the off axis angle at which the luminous intensity is half the axial luminous intensity

**4**

**3mm Discrete LED**  
**Low Current**  
**Diffused**

**Dialight**

**521-9324, -9325, -9326**

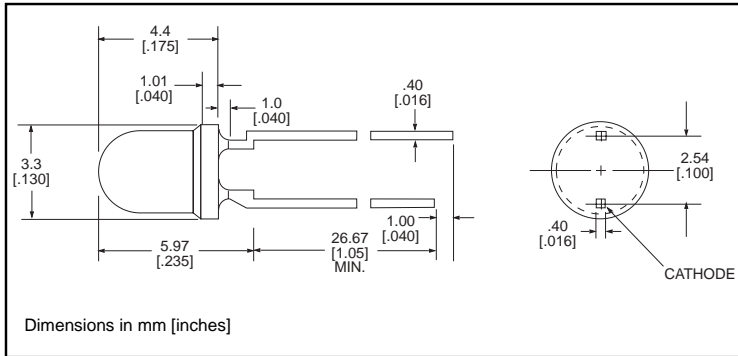

PART NO.	COLOR
521-9324	Red
521-9325	Yellow
521-9326	Green

**MOUNTING CLIP: 515-0006**  
 located on page 4-65

**ABSOLUTE MAXIMUM RATINGS** ( $T_A=25^\circ\text{C}$ )

	Red -9324	Yellow -9325	Green -9326
Power Dissipation (mW)	20	20	20
Forward Current (mA)	7	7	7
Derating (mA/°C) From 90°C	.7	.7	.7
Peak Current (mA) Pulse width = 10 $\mu\text{s}$	500	500	500
Operating Temperature (°C)	-55/+100	-55/+100	-55/+100
Storage Temperature (°C)	-55/+100	-55/+100	-55/+100
Soldering Temperature	260°C, 5 seconds, 1.6 mm from case		

Solder Adherence per MIL-STD-202E, Method 208C

**OPERATING CHARACTERISTICS** ( $T_A=25^\circ\text{C}$ )

		Red -9324	Yellow -9325	Green -9326
Luminous Intensity (mcd) $I_F=2\text{mA}$	Min.	1	1	1
	Typical	1.6	1.6	1.6
Peak Wavelength (nm) $\lambda_{\text{Peak}}$	Typical	635	585	565
Viewing Angle ( $2\theta$ )	Typical	60°	60°	60°
Forward Voltage (V) $I_F=2\text{mA}$	Typical	1.7	1.8	1.9
	Max.	2.2	2.7	2.2
Reverse Voltage (V), $I_R=50\mu\text{A}$	Min.	5	5	5

$\theta$  is the off axis angle at which the luminous intensity is half the axial luminous intensity

**3mm Discrete LED**  
**Bi-Color**  
**Non-Tinted, Diffused**



**521-9478, -9628, -9768**

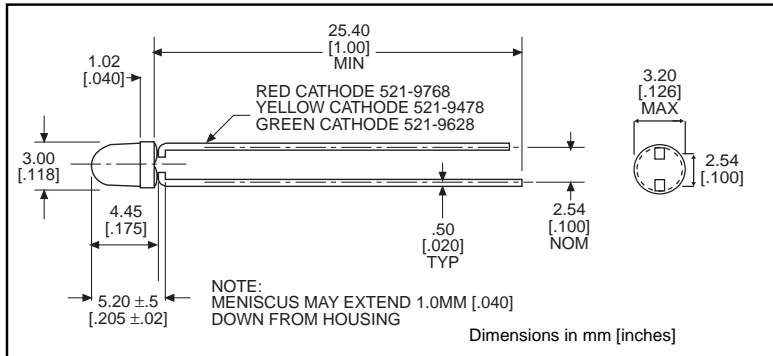

PART NO.	COLOR
521-9478	Yellow/Green
521-9628	Red/Green
521-9768	Red/Yellow

**MOUNTING CLIP: 515-0006**  
 located on page 4-65

<b>ABSOLUTE MAXIMUM RATINGS</b> (T <sub>A</sub> =25°C)	Yellow/Green <b>-9478</b>	Red/Green <b>-9628</b>	Red/Yellow <b>-9768</b>
Power Dissipation (mW)	60/100	140/100	100/60
Forward Current (mA)	20/30	40/30	30/20
Derating (mA/°C) From 25°C ' From 50°C	.25'/.40 <sup>1</sup>	.5/.4	.4'/.25 <sup>1</sup>
Peak Current (mA) Pulse width = 10µs	80/120	200/120	120/80
Operating Temperature (°C)	-55/+100	-55/+100	-55/+100
Storage Temperature (°C)	-55/+100	-55/+100	-55/+100
Soldering Temperature	260°C, 5 seconds, 1.66 mm from case		

Solder Adherence per MIL-STD-202E, Method 208C

<b>OPERATING CHARACTERISTICS</b> (T <sub>A</sub> =25°C)		Yellow/Green <b>-9478</b>	Red/Green <b>-9628</b>	Red/Yellow <b>-9768</b>
Luminous Intensity (mcd)	Min.	2.5/2.5	3.7*/1.1*	1.7*/1.7*
	Typical	4.3/6.3	12.6*/3.7*	5.6*/5.6*
Peak Wavelength (nm)	Typical	585/565	660/565	630/585
Viewing Angle (2θ <sup>1/2</sup> )	Typical	80°	200°	80°
Forward Voltage (V)	Typical	2.1/2.1	1.8/2.1	2/2.1
	Max.	2.8/2.8	2.4/2.8	2.8/2.8
Reverse Voltage (V) I <sub>R</sub> =100ua	Min.	5	5	5

θ<sup>1</sup> is the off axis angle at which the luminous intensity is half the axial luminous intensity

**3mm Discrete LED**  
**Bi-Color**  
**Non-Tinted, Diffused**

**Dialight**

**521-9459**

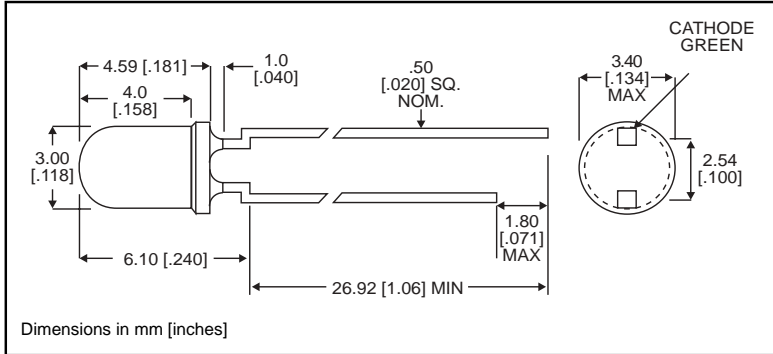

**PART NO.**

521-9459

**COLOR**

Red/Green

**MOUNTING CLIP:** 515-0006

located on page 4-65

**ABSOLUTE MAXIMUM RATINGS** ( $T_A=25^\circ\text{C}$ )

Red/Green  
**-9459**

Power Dissipation (mW)	140
Forward Current (mA)	45
Derating (mA/°C) <i>From 25°C</i>	.6
Peak Current (mA) <i>Pulse width = 10µs</i>	1000
Operating Temperature (°C)	-55/+100
Storage Temperature (°C)	-55/+100
Soldering Temperature	260°C, 5 seconds, 1.6 mm from case

*Solder Adherence per MIL-STD-202E, Method 208C*

**OPERATING CHARACTERISTICS** ( $T_A=25^\circ\text{C}$ )

Red/Green  
**-9459**

Luminous Intensity (mcd) $I_F=10\text{mA}$	Min. Typical	2.5/3.7 4.7/10
Peak Wavelength (nm) $\lambda$ Peak	Typical	635/565
Viewing Angle ( $2\theta_{1/2}$ )	Typical	50°
Forward Voltage (V) $I_F=10\text{mA}$	Typical Max.	2/2.1 2.8/2.8

$\theta$  is the off axis angle at which the luminous intensity is half the axial luminous intensity