

DELPHI SERIES



FEATURES

- ♦ High efficiency: 94.2% @ 54V/ 10.2A
- ♦ Standard footprint:
58.4x61.0x11.2mm (2.30"x2.40"x0.44")
(without heat spreader)
58.4x61.0x12.7mm (2.30"x2.40"x0.50")
(with heat spreader)
- ♦ Industry standard pin out
- ♦ Monotonic startup into normal and pre-bias loads
- ♦ Fixed frequency operation
- ♦ Input UVLO, output OVP, OCP, OTP
- ♦ No minimum load required
- ♦ Output trim range : -5% , +5%
- ♦ 2250V isolation
- ♦ Basic insulation
- ♦ ISO 9001, TL 9000, ISO 14001, QS 9000, OHSAS 18001 certified manufacturing facility
- ♦ UL/cUL 60950-1 (US & Canada)
Recognized, and TUV (EN60950-1) Certified

Delphi Series H48SA53010, Half Brick Family DC/DC Power Modules: 48V in, 54V/10.2A out

The Delphi Series H48SA53010 Half Brick, 38~60V input, 54V single output, isolated, open frame DC/DC converter is the latest offering from a world leader in power systems technology and manufacturing -- Delta Electronics, Inc. This product family provides up to 550 watts of power in an industry standard footprint. With creative design technology and optimization of component placement, these converters possess outstanding electrical and thermal performance, as well as extremely high reliability under highly stressful operating conditions. The Delphi Series converters meet all safety requirements with basic insulation. Typical efficiency of the 54V, 550W module is better than 94% and all modules are fully protected from abnormal input/output voltage, current and temperature conditions.

OPTIONS

- ♦ Positive remote on/off
- ♦ Heat spreader available for extended operation

APPLICATIONS

- ♦ Telecom / DataCom
- ♦ Wireless Networks
- ♦ Server and Data Storage
- ♦ Industrial/Test Equipment
- ♦ Power over Ethernet (PoE)

DATASHEET
DS_H48SA53010_08042011

 **DELTA**
Delta Electronics, Inc.



TECHNICAL SPECIFICATIONS

(T_A=25°C, a irflow rate=300 LFM, V_{in}=48Vdc, nominal Vout unless otherwise noted.)

| PARAMETER | NOTES and CONDITIONS | H48SA53010 (Standard) | | | |
|---|---|-----------------------|------|------|------------------|
| | | Min. | Typ. | Max. | Units |
| ABSOLUTE MAXIMUM RATINGS | | | | | |
| Input Voltage | | | | | |
| Continuous | | | | 60 | Vdc |
| Transient | Unit will withstand voltage transient for 10us | | | 100 | Vdc |
| Operating Case Temperature (With Heat spreader) | Please refer to fig 20 for the measuring point | -5 | | 108 | °C |
| Storage Temperature | | -55 | | 125 | °C |
| Input/Output Isolation Voltage | | | | 2250 | Vdc |
| INPUT CHARACTERISTICS | | | | | |
| Operating Input Voltage | | 38 | 48 | 60 | Vdc |
| Input Under-Voltage Lockout | | | | | |
| Turn-On Voltage Threshold | Io= 100% load | 32 | 34.5 | 36 | Vdc |
| Turn-Off Voltage Threshold | Io= 100% load | 30 | 32 | 34 | Vdc |
| Lockout Hysteresis Voltage | Io= 50% load | 2 | | | Vdc |
| Maximum Input Current | Vin=38V, 100% Load | | | 15.2 | A |
| No-Load Input Current | Vin=48V, Io= 0A. | | 200 | 250 | mA |
| Off Converter Input Current | Vin=48V | | 7 | 15 | mA |
| Inrush Current(I _{rt}) | With 150uF external input cap | | | 1 | A ² S |
| Input Terminal Ripple Current | RMS, Vin=48V, With 150uF/0.1ohm input cap | | 280 | 400 | mA |
| Input Reflected-Ripple Current | P-P thru 12uH inductor, 5Hz to 20MHz | | | 100 | mA |
| Input Voltage Ripple Rejection | 120 Hz | | 60 | | dB |
| OUTPUT CHARACTERISTICS | | | | | |
| Output Voltage Set Point | Vin=48V, Io=Io, max | 53.0 | 54.0 | 55.0 | Vdc |
| Output Voltage Regulation | | | | | |
| Over Load | Vin=40V to 60V, Io=Io,min to Io,max | | ±50 | | mV |
| Over Line | Vin=40V to 60V, Io= 100% load | | ±50 | | mV |
| Over Temperature | Tc=-5% to 55% | | ±200 | | mV |
| Total Output Voltage Range | Vin=40V to 60V, over sample load and temperature | 52.5 | | 55.5 | V |
| Output Voltage Ripple and Noise | 5Hz to 20MHz bandwidth | | | | |
| Peak-to-Peak | Full Load, 100uF ceramic, 220uF electrolytic | | 100 | 150 | mV |
| RMS | Full Load, 100uF ceramic, 220uF electrolytic | | 30 | 50 | mV |
| Operating Output Current Range | Full input range | 0 | | 10.2 | A |
| Operating Output Power Range | Full input range | 0 | | 550 | W |
| Output DC Current Protection | Full input range, Output Voltage 10% Low | 11 | | 13 | A |
| DYNAMIC CHARACTERISTICS | | | | | |
| Output Voltage Current Transient | 48V, 220uF Electrolytic & 100uF Ceramic load cap. | | | | |
| Positive Step Change in Output Current | 50% Io,max to 75% Io,max | | 300 | 800 | mV |
| Negative Step Change in Output Current | 75% Io,max to 50% Io,max | | 300 | 800 | mV |
| Settling Time (within 1% Vout nominal) | | | | 60 | µS |
| Turn-On Transient | | | | | |
| Turn on Delay time | Defined as time between enable and 10% Vout | 4 | | 50 | mS |
| Start-Up Time, enable on | Defined as time between Vout at 10% and 90% | 5 | | 100 | mS |
| Maximum Output Capacitance | Full load; 5% overshoot of Vout at startup | 240 | | 1080 | µF |
| EFFICIENCY | | | | | |
| 100% Load | Vin=48V | | 94.2 | | % |
| 20% Load | Vin=48V | | 91.0 | | % |
| ISOLATION CHARACTERISTICS | | | | | |
| Input to Output | | | | 2250 | Vdc |
| Isolation Resistance | | 10 | | | MQ |
| Isolation Capacitance | | | 1000 | | pF |
| FEATURE CHARACTERISTICS | | | | | |
| Switching Frequency | | | 140 | | kHz |
| ON/OFF Control, Negative Remote On/Off logic | | | | | |
| Logic Low (Module On) | Von/off | -2 | | 1.2 | V |
| Logic High (Module Off) | Von/off | 3 | | 18 | V |
| ON/OFF Control, Positive Remote On/Off logic | | | | | |
| Logic Low (Module Off) | Von/off | -2 | | 1.2 | V |
| Logic High (Module On) | Von/off | 3 | | 18 | V |
| ON/OFF Current (for both remote on/off logic) | Ion/off at Von/off=0.0V | | | 1 | mA |
| Leakage Current(for both remote on/off logic) | Logic High, Von/off=15V | | | 50 | µA |
| Output Voltage Trim Range | Vin=42V to 60V; Pout <= max rated power | 51.3 | | 56.7 | V |
| Output Voltage Trim Range | Vin=38V to 42V; Pout <= max rated power | 51.3 | | 54 | V |
| Output Over-Voltage Protection | Over full input range; Over full temp range | 58 | | 60 | V |
| GENERAL SPECIFICATIONS | | | | | |
| MTBF | Io=80% of Io, max; Ta=25°C, airflow rate=300 LFM | | 2.95 | | M hours |
| Weight(without heatspreader) | | | 74 | | grams |
| Weight(with heatspreader) | | | 112 | | grams |
| Over-Temperature Shutdown(With Heatspreader) | Please refer to Fig 20. for the measuring point | | 116 | | °C |



ELECTRICAL CHARACTERISTICS CURVES

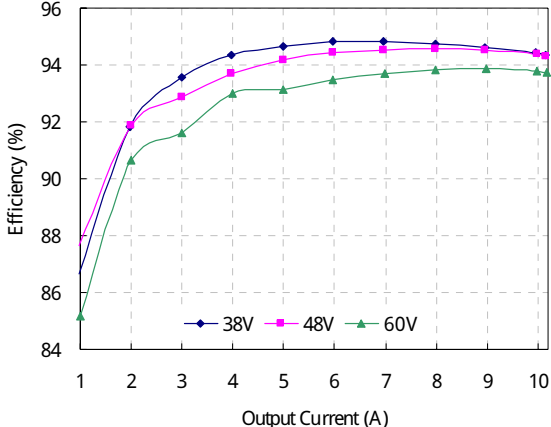

Figure 1: Efficiency vs. load current for minimum, nominal, and maximum input voltage at 25° C. Vout=54V.

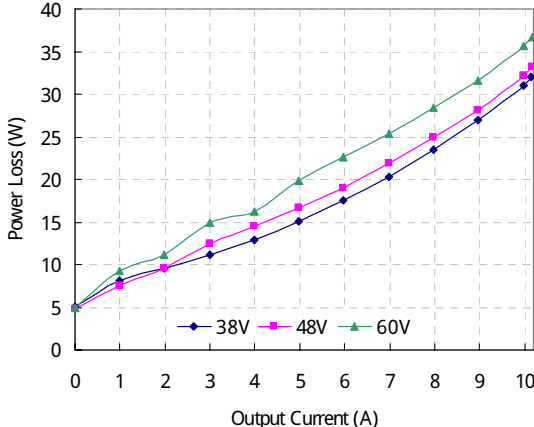

Figure 2: Power dissipation vs. load current for minimum, nominal, and maximum input voltage at 25° C. Vout=54V.

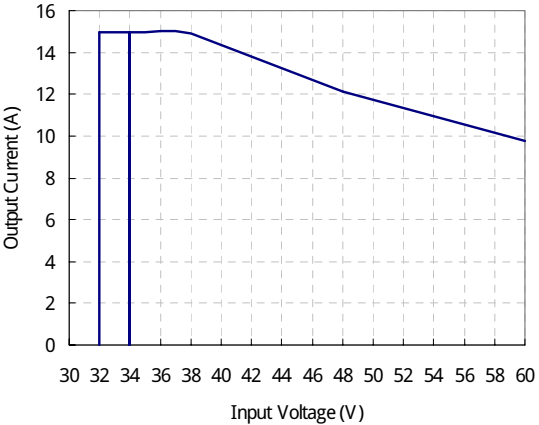

Figure 3: Typical input characteristics at room temperature.

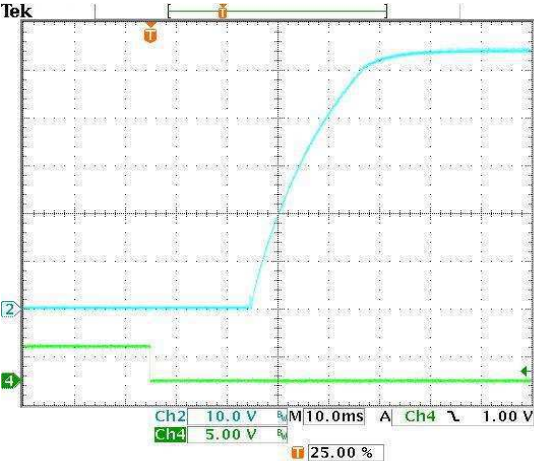

Figure 4: Turn-on transient at full rated load current (resistive load) (10 ms/div). Top Trace: Vout; 10V/div; Bottom Trace: ON/OFF input; 5V/div.



ELECTRICAL CHARACTERISTICS CURVES

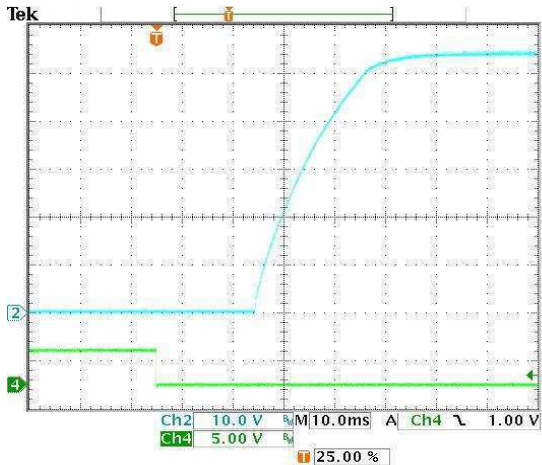

Figure 5: Turn-on transient at zero load current (10 ms/div).
Top Trace: Vout, 10V/div; Bottom Trace: ON/OFF input, 5V/div.

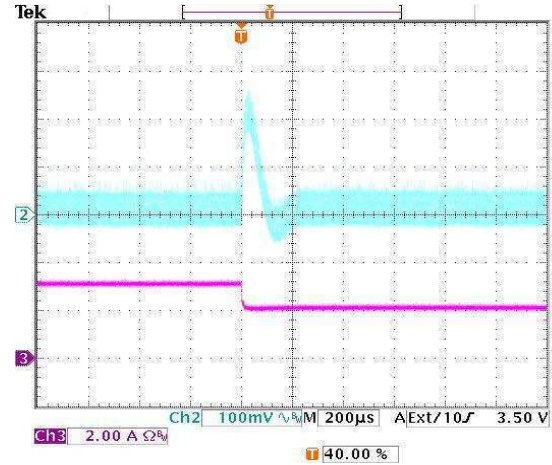

Figure 6: Output voltage response to step-change in load current (75%-50% of I_o , max; $di/dt = 2.5A/\mu s$).
Load cap: 300µF, electrolytic capacitor and 100µF ceramic capacitor. Top Trace: Vout (100mV/div), Bottom Trace: Iout (5A/div). Scope measurement should be made using a BNC cable (length shorter than 20 inches). Position the load between 51 mm to 76 mm (2 inches to 3 inches) from the module.

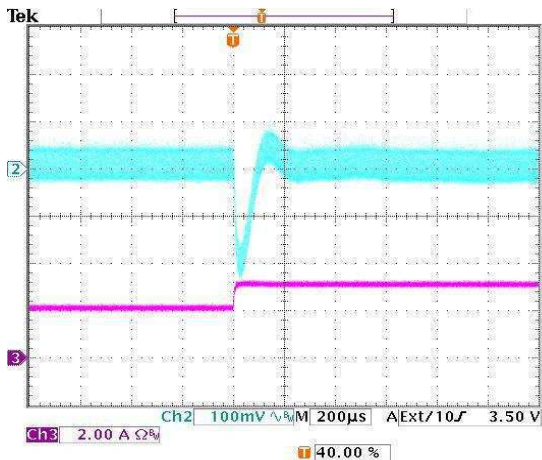

Figure 7: Output voltage response to step-change in load current (50%-75% of I_o , max; $di/dt = 2.5A/\mu s$).
Load cap: 300µF, electrolytic capacitor and 100µF ceramic capacitor. Top Trace: Vout (100 mV/div), Bottom Trace: Iout (5A/div). Scope measurement should be made using a BNC cable (length shorter than 20 inches). Position the load between 51 mm to 76 mm (2 inches to 3 inches) from the module.

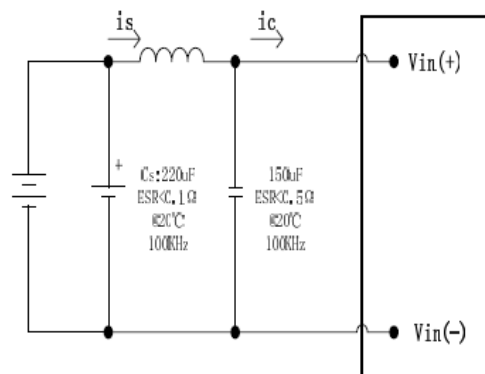

Figure 8: Test set-up diagram showing measurement points for Input Terminal Ripple Current and Input Reflected Ripple Current. Note: Measured input reflected-ripple current with a simulated source Inductance (LTEST) of 12 µH. Capacitor Cs offset possible battery impedance. Measure current as shown below.



ELECTRICAL CHARACTERISTICS CURVES

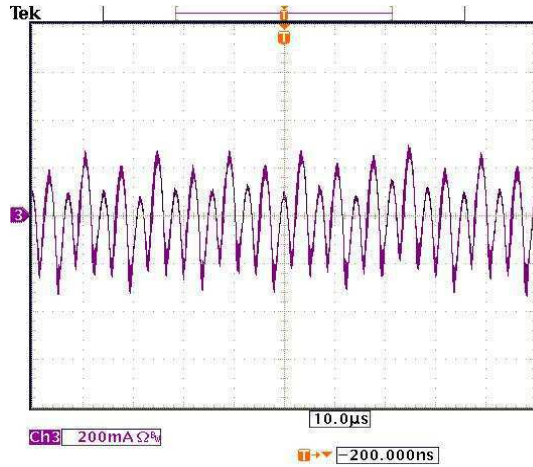

Figure 9: Input Terminal Ripple Current, i_c , at nominal input voltage and rated load current with $12\mu\text{H}$ source impedance and $150\mu\text{F}$ electrolytic capacitor (200 mA/div).

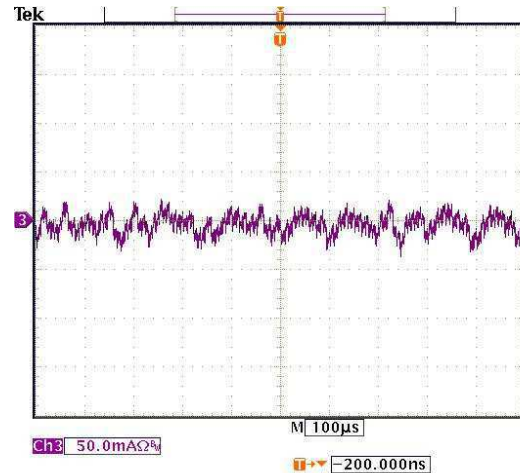

Figure 10: Input reflected ripple current, i_s , through a $12\mu\text{H}$ source inductor at nominal input voltage and rated load current (50 mA/div).

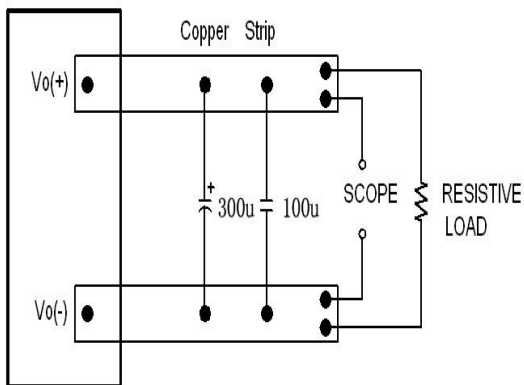

Figure 11: Output voltage noise and ripple measurement test setup.

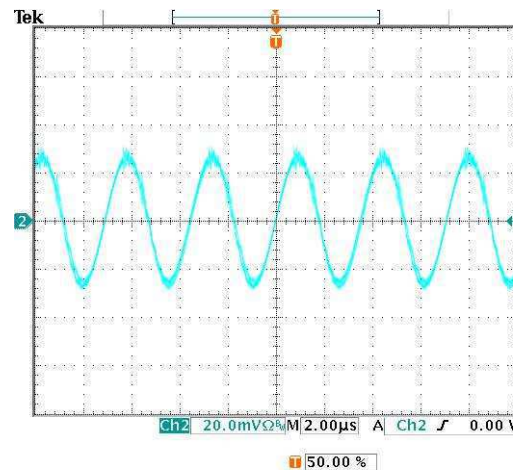

Figure 12: Output voltage ripple at nominal input voltage and rated load current (20 mV/div). Load capacitance: $100\mu\text{F}$ ceramic capacitor and $220\mu\text{F}$ electrolytic capacitor. Bandwidth: 20 MHz. Scope measurement should be made using a BNC cable (length shorter than 20 inches). Position the load between 51 mm to 76 mm (2 inches to 3 inches) from the module.



ELECTRICAL CHARACTERISTICS CURVES

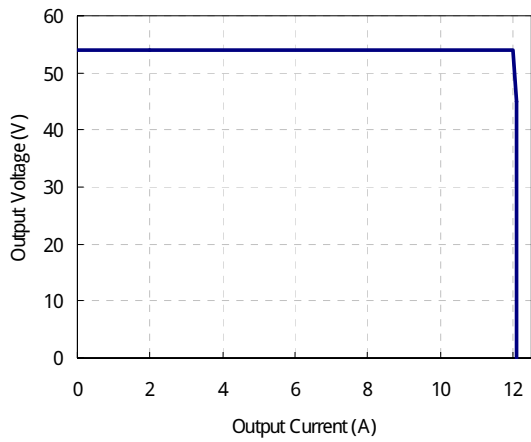

Figure 13: Output voltage vs. load current showing typical current limit curves and converter shutdown points.

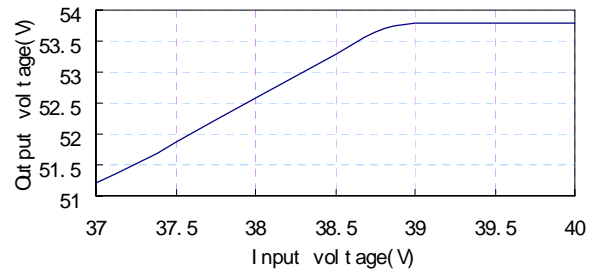

Figure 14: Output voltage VS low line input voltage at full load



DESIGN CONSIDERATIONS

Input Source Impedance

The impedance of the input source connecting to the DC/DC power modules will interact with the modules and affect the stability. A low ac-impedance input source is recommended. If the source inductance is more than a few μH , we advise adding a 10 to 100 μF electrolytic capacitor (ESR $< 0.7 \Omega$ at 100 kHz) mounted close to the input of the module to improve the stability.

Layout and EMC Considerations

Delta's DC/DC power modules are designed to operate in a wide variety of systems and applications. For design assistance with EMC compliance and related PWB layout issues, please contact Delta's technical support team. An external input filter module is available for easier EMC compliance design. Application notes to assist designers in addressing these issues are pending release.

Safety Considerations

The power module must be installed in compliance with the spacing and separation requirements of the end-user's safety agency standard, i.e., UL60950-1, CSA C22.2 NO. 60950-1 2nd and IEC 60950-1 2nd : 2005 and EN 60950-1 2nd: 2006+A11+A1: 2010, if the system in which the power module is to be used must meet safety agency requirements.

When the input source is 60 Vdc or below, the power module meets SELV (safety extra-low voltage) requirements. If the input source is a hazardous voltage which is greater than 60 Vdc and less than or equal to 75 Vdc, for the module's output to meet SELV requirements, all of the following must be met:

- The input source must be insulated from any hazardous voltages, including the ac mains, with reinforced insulation.
- One V_i pin and one V_o pin are grounded, or all the input and output pins are kept floating.
- The input terminals of the module are not operator accessible.

- A SELV reliability test is conducted on the system where the module is used to ensure that under a single fault, hazardous voltage does not appear at the module's output.

Do not ground one of the input pins without grounding one of the output pins. This connection may allow a non-SELV voltage to appear between the output pin and ground.

The power module has extra-low voltage (ELV) outputs when all inputs are ELV.

This power module is not internally fused. To achieve optimum safety and system protection, an input line fuse is highly recommended. The safety agencies require a fuse with 50A maximum rating to be installed in the ungrounded lead. A lower rated fuse can be used based on the maximum inrush transient energy and maximum input current.

Soldering and Cleaning Considerations

Post solder cleaning is usually the final board assembly process before the board or system undergoes electrical testing. Inadequate cleaning and/or drying may lower the reliability of a power module and severely affect the finished circuit board assembly test. Adequate cleaning and/or drying is especially important for un-encapsulated and/or open frame type power modules. For assistance on appropriate soldering and cleaning procedures, please contact Delta's technical support team.



FEATURES DESCRIPTIONS

Over-Current Protection

The modules include an internal output over-current protection circuit, which will endure current limiting for an unlimited duration during output overload. If the output current exceeds the OCP set point, the modules will automatically shut down, the hiccup mode is default and latch mode is optional.

For hiccup mode, the module will try to restart after shutdown. If the overload condition still exists, the module will shut down again. This restart trial will continue until the overload condition is corrected.

For latch mode, the module will latch off once it shutdown. The latch is reset by either cycling the input power or by toggling the on/off signal for one second.

Over-Voltage Protection

The modules include an internal output over-voltage protection circuit, which will endure output voltage limiting. If the output voltage exceeds the OVP set point, the modules will automatically shut down, the latch mode is default and the hiccup mode is optional.

For hiccup mode, the module will try to restart after shutdown. If the overvoltage condition still exists, the module will shut down again. This restart trial will continue until the over-voltage condition is corrected.

For latch mode, the module will latch off once it shutdown. The latch is reset by either cycling the input power or by toggling the on/off signal for one second.

Over-Temperature Protection

The over-temperature protection consists of circuitry that provides protection from thermal damage. If the temperature exceeds the over-temperature threshold the module will shut down, the hiccup mode is default and latch mode is optional.

For hiccup mode, the module will monitor the module temperature after shutdown. Once the temperature is within the specification, the module will be auto-restarted.

For latch mode, the module will latch off once it shutdown. The latch is reset by either cycling the input power or by toggling the on/off signal for one second.

Remote On/Off

The remote on/off feature on the module can be either negative or positive logic. Negative logic turns the module on during a logic low and off during a logic high. Positive logic turns the modules on during a logic high and off during a logic low.

Remote on/off can be controlled by an external switch between the on/off terminal and the Vin (-) terminal. The switch can be an open collector or open drain.

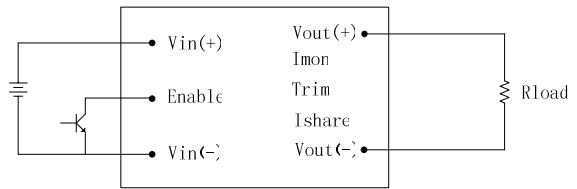

Figure 15: Remote on/off implementation

Current Share

The modules can operate in parallel up to 3 units and provide up to 1600W output power without any or-ing FET or diode. Between 50% and 100% max load rating, current-sharing accuracy is +/-2.5%. The equation of Ishare PIN voltage vs. Io is:

$$I_{share} = 0.25 \cdot I_o + 0.25$$

Ishare unit is Volt, and Io unit is Amp.

In parallel application, if the load current is larger than one module's full current, the modules can not restart automatically even in hiccup mode. Either cycling the input power or toggling the on/off signal for one second can startup the modules.

Current Monitor

Imon shall sink a current proportional to output current and reference to Vout (-). This pin can be pulled up through an external resistor to an external voltage, the external voltage ranges from 1.5V to Vout (+) +3.3V. Output current equals Imon×10,000. Accuracy is +/-0.5A.



FEATURES DESCRIPTIONS (CON.)

Output Voltage Adjustment (TRIM)

To increase or decrease the output voltage set point, the modules may be connected with an external resistor between the TRIM pin and either the Vout (+) or Vout (-). The TRIM pin should be left open if this feature is not used.

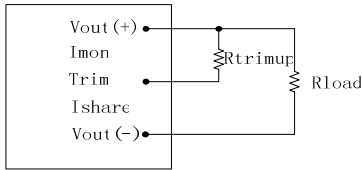

Figure 16: Circuit configuration for trim-up (increase output voltage)

If the external resistor is connected between the TRIM and Vout (+) pins, the output voltage set point increases (Fig. 15). The external resistor value required to obtain a percentage of output voltage change $\Delta\%$ is defined as:

$$R_{trimup} := \left[\frac{V_{out} \cdot (100 + \Delta\%)}{1.225 \Delta\%} - \frac{(100 + 2\Delta\%)}{\Delta\%} \right] k\Omega$$

Ex. When trim up to 56.7V from 54V
 $\Delta\% = 100 \cdot (56.7 - 54) / 54 = 5$

$$R_{trimup} := \left[\frac{54 \cdot (100 + 5)}{1.225 \cdot 5} - \frac{100 + 2 \cdot 5}{5} \right] k\Omega$$

$R_{trim_up} = 903.7 \text{ k}\Omega$

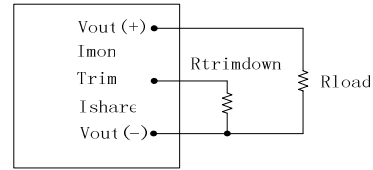

Figure 17: Circuit configuration for trim-down (decrease output voltage)

If the external resistor is connected between the TRIM and Vout (-), the output voltage set point decreases (Fig. 16). The external resistor value required to obtain a percentage of output voltage change $\Delta\%$ is defined as

$$R_{trimdown} := \left(\frac{100}{\Delta\%} - 2 \right) k\Omega$$

Ex. When trim down to 51.3V from 54V
 $\Delta\% = 100 \cdot (54 - 51.3) / 54 = 5$

$$R_{trimdown} := \left(\frac{100}{5} - 2 \right) k\Omega$$

$R_{trim_down} = 18 \text{ k}\Omega$

The typical resistor value can be seen in below figure 17.

| Output voltage | Resistor value (kΩ) |
|----------------|---------------------|
| 56.7V | 903.7 |
| 51.3V | 18 |

Figure 18: Trim resistor value example for popular output voltages

When using trim function to increase output voltage, the output power should increase accordingly. Care should be taken to ensure that the maximum output power of the module remains at or below the maximum rated power.



THERMAL CONSIDERATIONS

Thermal management is an important part of the system design. To ensure proper, reliable operation, sufficient cooling of the power module is needed over the entire temperature range of the module. Convection cooling is usually the dominant mode of heat transfer.

Hence, the choice of equipment to characterize the thermal performance of the power module is a wind tunnel.

Thermal Testing Setup

Delta's DC/DC power modules are characterized in heated vertical wind tunnels that simulate the thermal environments encountered in most electronics equipment. This type of equipment commonly uses vertically mounted circuit cards in cabinet racks in which the power modules are mounted.

The following figure shows the wind tunnel characterization setup. The power module is mounted on a test PWB and is vertically positioned within the wind tunnel. The space between the neighboring PWB and the top of the power module is constantly kept at 6.35mm (0.25").

Thermal De-rating

Heat can be removed by increasing airflow over the module. The module's maximum device temperature is to be defined and the measured location is illustrated in Figure 19. To enhance system reliability, the power module should always be operated below the maximum operating temperature. If the temperature exceeds the maximum module temperature, reliability of the unit may be affected.

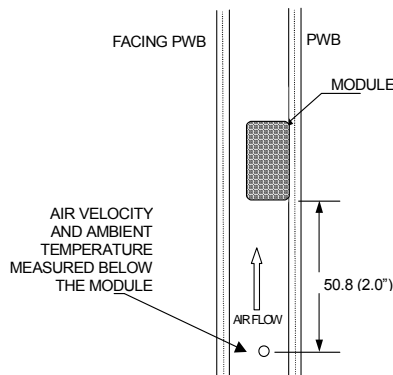

Note: Wind Tunnel Test Setup Figure Dimensions are in millimeters and (Inches)

Figure 19: Wind tunnel test setup

THERMAL CURVES (WITH HEATSPREADER)

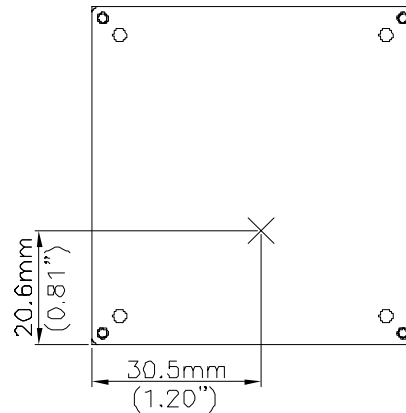

Figure 20: Temperature measurement location *
The allowed maximum hot spot temperature is defined at 108%

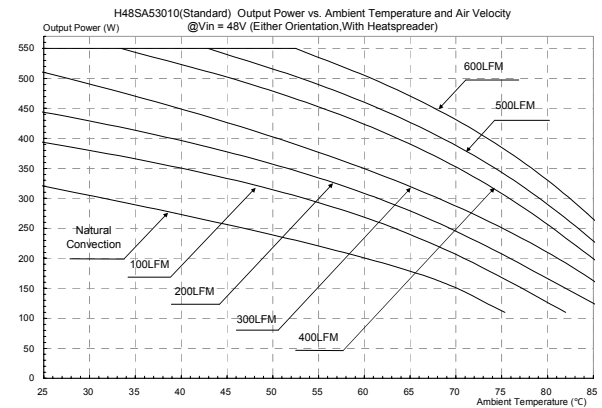
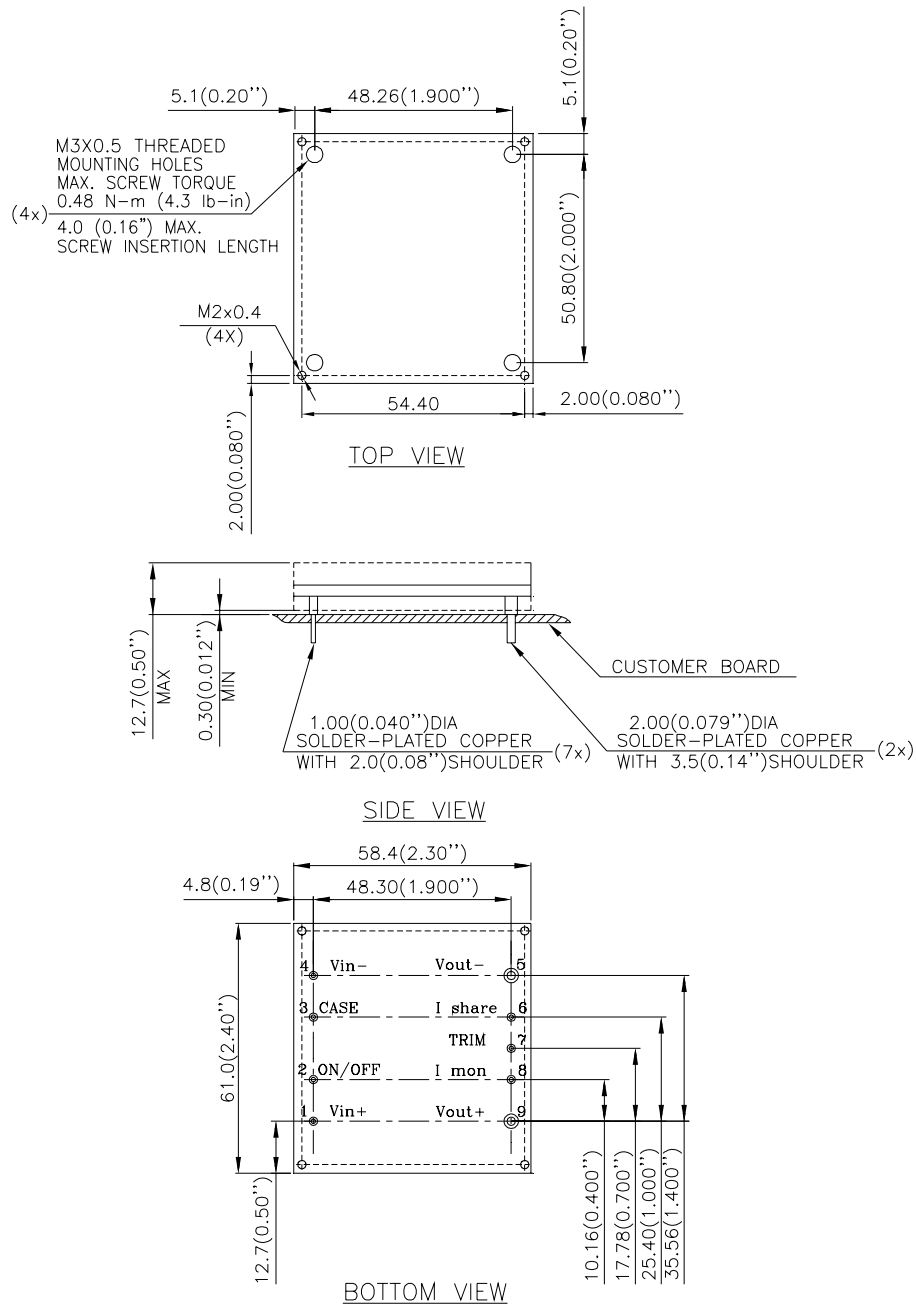

Figure 21: Output Power vs. ambient temperature and air velocity
@ $V_{in}=48V$, $V_{out}=54V$ (Either Orientation)



MECHANICAL DRAWING (WITH HEAT SPREADER)

* For modules with through-hole pins and the optional heatspreader, they are intended for wave soldering assembly onto system boards; please do not subject such modules through reflow temperature profile.



NOTES:
 DIMENSIONS ARE IN MILLIMETERS AND (INCHES)
 TOLERANCES: X.Xmm±0.5mm(X.XX in.±0.02 in.)
 X.XXmm±0.25mm(X.XXX in.±0.010 in.)



MECHANICAL DRAWING (WITHOUT HEAT SPREADER)

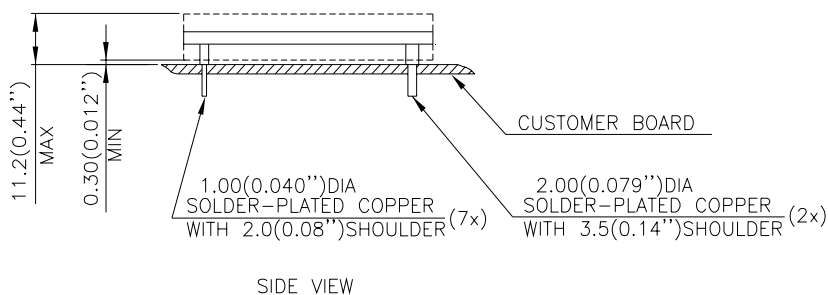
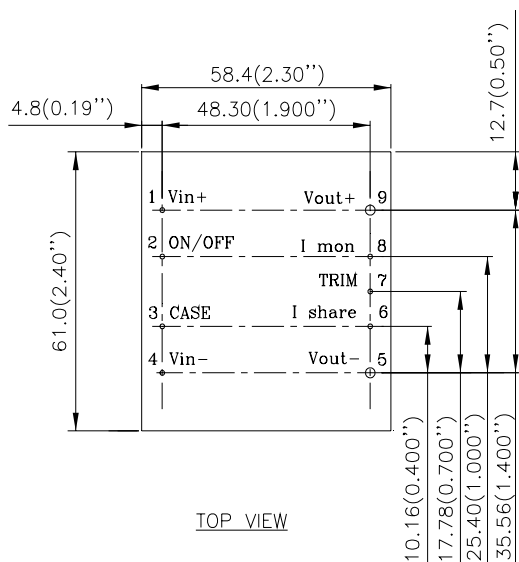

NOTES:
 DIMENSIONS ARE IN MILLIMETERS AND (INCHES)
 TOLERANCES: X.Xmm±0.5mm(X.XX in.±0.02 in.)
 X.XXmm±0.25mm(X.XXX in.±0.010 in.)

| Pin No. | Name | Function |
|---------|---------|---|
| 1 | Vin(+) | Positive input voltage |
| 2 | On/Off | Turns unit On (low) or Off (high or open) |
| 3 | Case | Optional connection to baseplate |
| 4 | Vin(-) | Input voltage return |
| 5 | Vout(-) | Output voltage return |
| 6 | Ishare | Current share |
| 7 | TRIM | Output voltage trim |
| 8 | Imon | Current monitor |
| 9 | Vout(+) | Positive output voltage |

Notes:

- Pins 1-4, 6-8 are 1.00mm (0.040") diameter
- Pins 5 and 9 are 2.00mm (0.079") diameter
- All pins are copper with Tin plating.



PART NUMBERING SYSTEM

| H | 48 | S | A | 530 | 10 | N | N | F | A |
|----------------|---------------|-------------------|----------------|-----------|----------------|------------------------------|--|---------------------------|---|
| Form Factor | Input Voltage | Number of outputs | Output Voltage | Mounting | Output Current | ON/OFF Logic | Pin Length | | Option Code |
| H - Half-Brick | 48-38V~60V | S - Single | A - Advanced | 530 - 54V | 10 - 10.2A | N - Negative P - Positive | N - 0.145" R - 0.170" K - 0.110" | F-RoHS 6/6 (Lead Free) | A - Standard Functions H - With Heatspreader |

MODEL LIST

| Model Name | Input Voltage | Output Voltage | Output Current | Efficiency 48Vin @ Full load |
|----------------|---------------|----------------|----------------|---------------------------------|
| H48SA53010NNFA | 38V~60V | 54V | 10.2A | 94.2% |
| H48SA53010NNFH | 38V~60V | 54V | 10.2A | 94.2% |

CONTACT: www.delta.com.tw/dc dc

USA:

Telephone:
East Coast: (888) 335 8201
West Coast: (888) 335 8208
Fax: (978) 656 3964
Email: DCDC@delta-corp.com

Europe:

Telephone: +41 31 998 53 11
Fax: +41 31 998 53 53
Email: DCDC@delta-es.tw

Asia & the rest of world:

Telephone: +886 3 4526107 ext. 6220
Fax: +886 3 4513485
Email: DCDC@delta.com.tw

WARRANTY

Delta offers a two (2) year limited warranty. Complete warranty information is listed on our web site or is available upon request from Delta.

Information furnished by Delta is believed to be accurate and reliable. However, no responsibility is assumed by Delta for its use, nor for any infringements of patents or other rights of third parties, which may result from its use. No license is granted by implication or otherwise under any patent or patent rights of Delta. Delta reserves the right to revise these specifications at any time, without notice.

DS_H48SA53010_08042011