

Mega Power Chopper IGBTMOD™ 1400 Amperes/1200 Volts

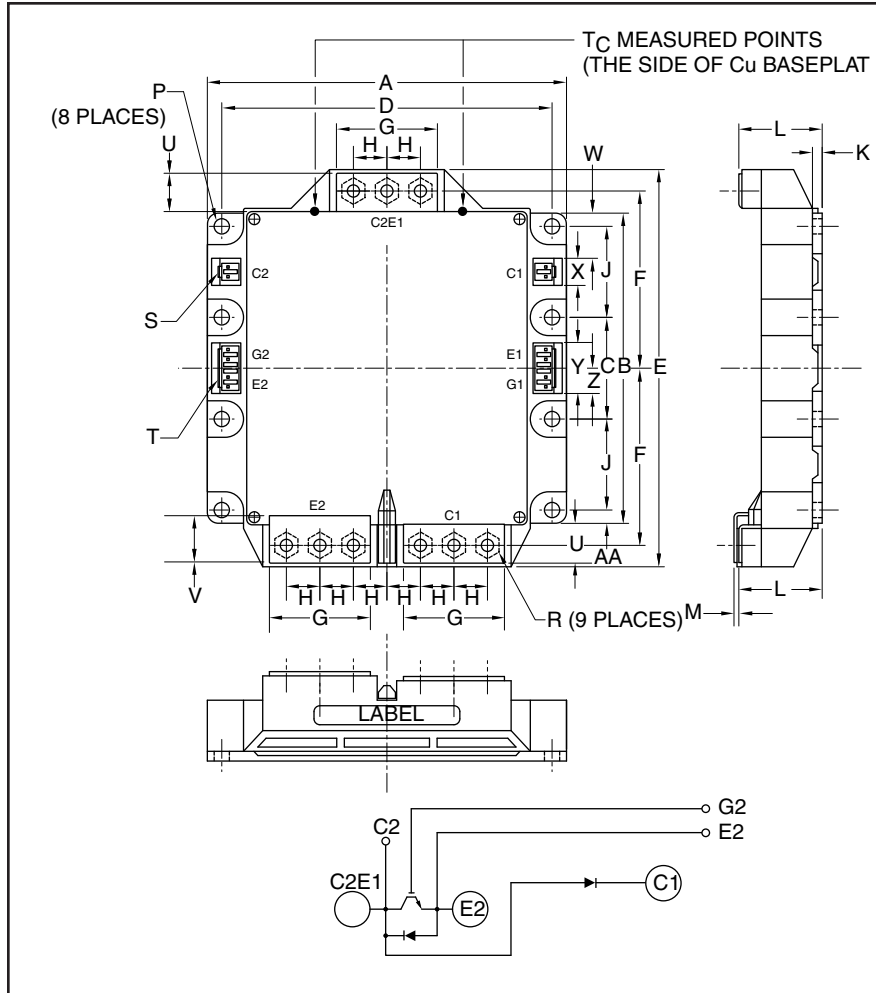

Outline Drawing and Circuit Diagram

Dimensions	Inches	Millimeters
A	5.91	150.0
B	5.10	129.5
C	1.67±0.01	42.5±0.25
D	5.41±0.01	137.5±0.25
E	6.54	166.0
F	2.91±0.01	74.0±0.25
G	1.65	42.0
H	0.55	14.0
J	1.50±0.01	38.0±0.25
K	0.16	4.0

Housing Type (J.S.T. MFG. CO. LTD)

S = VHR-2N
T = VHR-5N

Dimensions	Inches	Millimeters
L	1.36 +0.04/-0.02	34.6 +1.0/-0.5
M	0.075±0.08	1.9±0.2
P	0.26	6.5
R	M6 Metric	M6
U	0.62	15.7
V	0.71	18.0
W	0.75	19.0
X	0.43	11.0
Y	0.83	21.0
Z	0.41	10.5
AA	0.22	5.5



Description:

Powerex Chopper IGBTMOD™ Modules are designed for use in switching applications. Each module consists of one IGBT Transistor having a reverse-connected super-fast recovery free-wheel diode and an anode-collector connected super-fast recovery free-wheel diode. All components and interconnects are isolated from the heat sinking baseplate, offering simplified system assembly and thermal management.

Features:

- Low Drive Power
- Low V_{CE(sat)}
- Discrete Super-Fast Recovery Free-Wheel Diode
- Isolated Baseplate for Easy Heat Sinking

Applications:

- High Power DC Power Supply
- Large DC Motor Drives
- Utility Interface Inverters

Ordering Information:

Example: Select the complete module number you desire from the table - i.e. CM1400E3U-24NF is a 1200V (V_{CES}), 1400 Ampere Chopper IGBTMOD Power Module.

Type	Current Rating Amperes	V _{CES} Volts (x 50)
CM	1400	24



Powerex, Inc., 173 Pavilion Lane, Youngwood, Pennsylvania 15697 (724) 925-7272

CM1400E3U-24NF
Mega Power Chopper IGBTMOD™
1400 Amperes/1200 Volts

Absolute Maximum Ratings, $T_j = 25^\circ\text{C}$ unless otherwise specified

Ratings	Symbol	CM1400E3U-24NF	Units
Junction Temperature	T_j	-40 to 150	$^\circ\text{C}$
Storage Temperature	T_{stg}	-40 to 125	$^\circ\text{C}$
Collector-Emitter Voltage (G-E SHORT)	V_{CES}	1200	Volts
Gate-Emitter Voltage (C-E SHORT)	V_{GES}	± 20	Volts
Collector Current DC ($T_C = 94^\circ\text{C}$)	I_C	1400	Amperes
Peak Collector Current (Pulse, $T_j \leq 150^\circ\text{C}$)	I_{CM}	2800*	Amperes
Emitter Current ($T_C = 25^\circ\text{C}$)**	I_E	100	Amperes
Peak Emitter Current (Pulse)**	I_{EM}	200*	Amperes
Maximum Collector Dissipation ($T_j < 150^\circ\text{C}$, $T_C = 25^\circ\text{C}$)	P_C	3900	Watts
Mounting Torque, M6 Mounting Screws	–	40	in-lb
Mounting Torque, M6 Main Terminal Screw	–	40	in-lb
Weight (Typical)	–	1400	Grams
Isolation Voltage (Main Terminal to Baseplate, AC 1 min.)	V_{iso}	2500	Volts

Clamp Diode Part, $T_j = 25^\circ\text{C}$ unless otherwise specified

Repetitive Peak Reverse Voltage	V_{RRM}	1200	Volts
Forward Current ($T_C = 25^\circ\text{C}$)	I_F	1400*	Amperes
Peak Forward Current (Pulse)	I_{FM}	2800*	Amperes

CM1400E3U-24NF
Mega Power Chopper IGBTMOD™
 1400 Amperes/1200 Volts

Electrical Characteristics, $T_j = 25^\circ\text{C}$ unless otherwise specified

Characteristics	Symbol	Test Conditions	Min.	Typ.	Max.	Units
Collector-Cutoff Current	I_{CES}	$V_{CE} = V_{CES}, V_{GE} = 0V$	–	–	1	mA
Gate-Emitter Threshold Voltage	$V_{GE(th)}$	$I_C = 140mA, V_{CE} = 10V$	6	7	8	Volts
Gate Leakage Current	I_{GES}	$V_{GE} = V_{GES}, V_{CE} = 0V$	–	–	1.5	μA
Collector-Emitter Saturation Voltage (Without Lead Resistance)	$V_{CE(sat)}$ (Chip)	$I_C = 1400A, V_{GE} = 15V, T_j = 25^\circ\text{C}$ $I_C = 1400A, V_{GE} = 15V, T_j = 125^\circ\text{C}$	–	1.8 2.0	2.5 –	Volts
Module Lead Resistance	$R_{(lead)}$	$I_C = 1400A, \text{Terminal-Chip}$	–	0.286	–	m Ω
Input Capacitance	C_{ies}		–	–	220	nF
Output Capacitance	C_{oes}	$V_{CE} = 10V, V_{GE} = 0V$	–	–	25	nF
Reverse Transfer Capacitance	C_{res}		–	–	4.7	nF
Total Gate Charge	Q_G	$V_{CC} = 600V, I_C = 1400A, V_{GE} = 15V$	–	7200	–	nC
Inductive Turn-on Delay Time	$t_{d(on)}$	$V_{CC} = 600V, I_C = 1400A,$	–	–	800	ns
Load Rise Time	t_r	$V_{GE1} = V_{GE2} = 15V,$	–	–	300	ns
Switch Turn-off Delay Time	$t_{d(off)}$	$R_G = 0.22\Omega, \text{Inductive Load}$	–	–	1000	ns
Times Fall Time	t_f	Switching Operation	–	–	300	ns
Reverse Recovery Time*	t_{rr}	$I_E = 100A$	–	–	700	ns
Reverse Recovery Charge*	Q_{rr}		–	90	–	μC
Emitter-Collector Voltage**	V_{EC}	$I_E = 100A, V_{GE} = 0V$	–	–	3.0	Volts
External Gate Resistance	R_G		0.22	–	2.2	Ω

Clamp Diode Characteristics, $T_j = 25^\circ\text{C}$ unless otherwise specified

Characteristics	Symbol	Test Conditions	Min.	Typ.	Max.	Units
Emitter-Collector Voltage (without Lead Resistance)	V_{FM} (Chip)	$I_F = 1400A, \text{Clamp Diode Part}$	–	–	3.2	Volts
Reverse Recovery Time	t_{rr}	$I_F = 1400A, \text{Clamp Diode Part}$	–	–	700	ns
Reverse Recovery Charge	Q_{rr}		–	90	–	μC

* Pulse width and repetition rate should be such that the device junction temperature (T_j) does not exceed $T_{j(max)}$ rating.

** Represents characteristics of the anti-parallel, emitter-to-collector free-wheel diode (FWDi).

Thermal and Mechanical Characteristics, $T_j = 25^\circ\text{C}$ unless otherwise specified

Characteristics	Symbol	Test Conditions	Min.	Typ.	Max.	Units
Thermal Resistance, Junction to Case	$R_{th(j-c)Q}$	Per IGBT 1/2 Module, T_C Reference Point per Outline Drawing	–	–	0.032	$^\circ\text{C/W}$
Thermal Resistance, Junction to Case	$R_{th(j-c)D}$	Per Clamp Diode 1/2 Module, T_C Reference Point per Outline Drawing	–	–	0.053	$^\circ\text{C/W}$
Thermal Resistance, Junction to Case	$R_{th(j-c')Q}$	Per IGBT 1/2 Module, T_C Reference Point Under Chip	–	–	0.014	$^\circ\text{C/W}$
Thermal Resistance, Junction to Case	$R_{th(j-c')D}$	Per Clamp Diode 1/2 Module, T_C Reference Point Under Chip	–	–	0.023	$^\circ\text{C/W}$
Contact Thermal Resistance	$R_{th(c-f)}$	Per 1/2 Module, Thermal Grease Applied	–	0.016	–	$^\circ\text{C/W}$

CM1400E3U-24NF
Mega Power Chopper IGBTMOD™
 1400 Amperes/1200 Volts

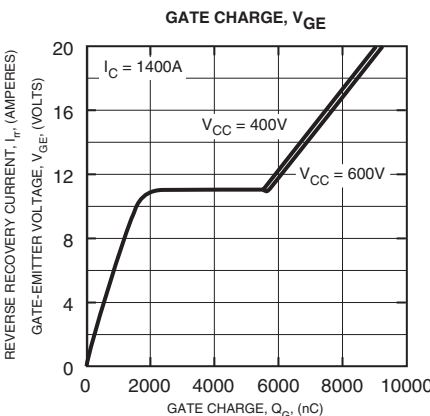
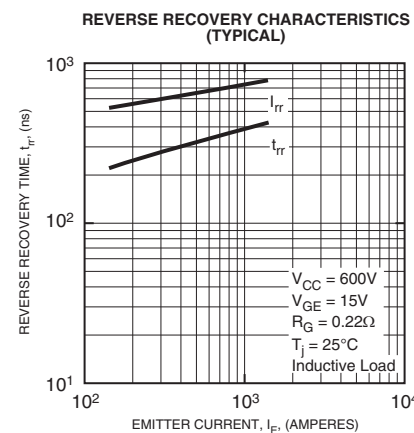
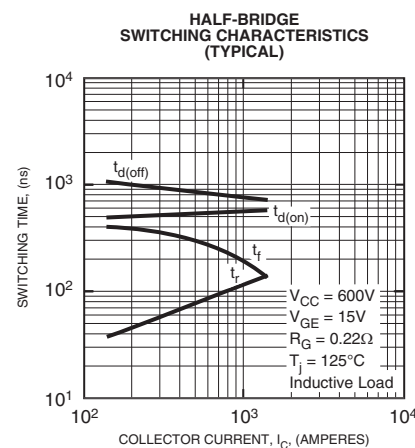
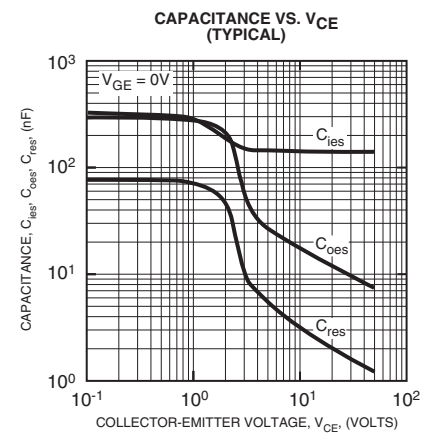
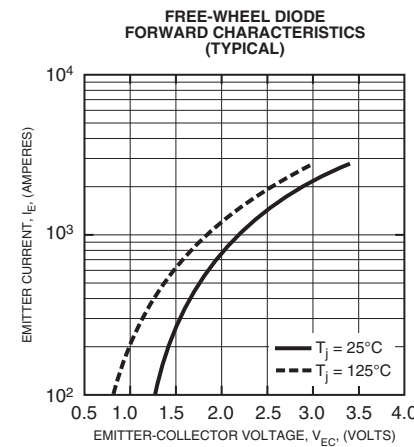
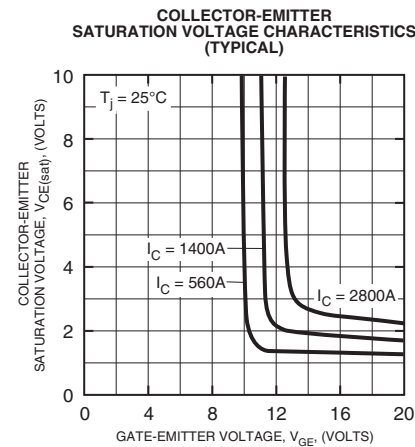
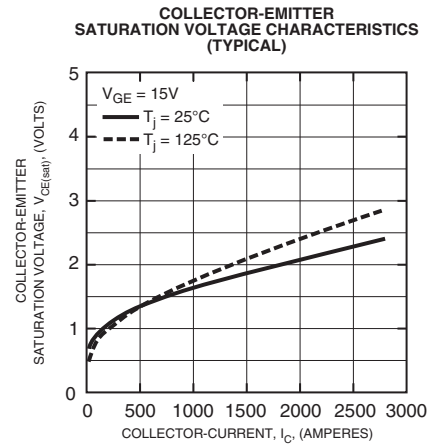
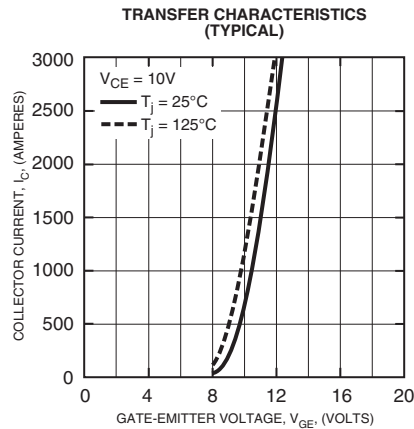
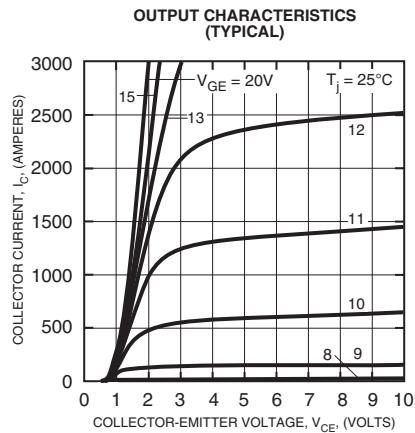

CM1400E3U-24NF
Mega Power Chopper IGBTMOD™
 1400 Amperes/1200 Volts

