

FEATURES

- POWER MOS TECHNOLOGY — 2A peak rating
- HIGH GAIN BANDWIDTH PRODUCT — 150MHz
- VERY FAST SLEW RATE — 200V/μs
- PROTECTED OUTPUT STAGE — Thermal shutoff
- EXCELLENT LINEARITY — Class A/B output
- WIDE SUPPLY RANGE — ±12V to ±40V
- LOW BIAS CURRENT, LOW NOISE — FET input

APPLICATIONS

- VIDEO DISTRIBUTION AND AND AMPLIFICATION
- HIGH SPEED DEFLECTION CIRCUITS
- POWER TRANSDUCERS TO 2MHz
- COAXIAL LINE DRIVERS
- POWER LED OR LASER DIODE EXCITATION

DESCRIPTION

The PA09 is a high voltage, high output current operational amplifier optimized to drive a variety of loads from DC through the video frequency range. Excellent input accuracy is achieved with a dual monolithic FET input transistor which is cascoded by two high voltage transistors to provide outstanding common mode characteristics. All internal current and voltage levels are referenced to a zener diode biased on by a current source. As a result, the PA09 exhibits superior DC and AC stability over a wide supply and temperature range.

High speed and freedom from second breakdown is assured by a complementary Power MOS output stage. For optimum linearity, especially at low levels, the Power MOS transistors are biased in the class A/B mode. Thermal shutoff provides full protection against overheating and limits the heatsink requirements to dissipate the internal power losses under normal operating conditions. A built-in current limit protects the amplifier against overloading. Transient inductive load kickback protection is provided by two internal clamping diodes. External phase compensation allows the user maximum flexibility in obtaining the optimum slew rate and gain bandwidth product at all gain settings. For continuous operation under load, a heatsink of proper rating is recommended.

This hybrid integrated circuit utilizes thick film (cermet) resistors, ceramic capacitors and silicon semiconductor chips to maximize reliability, minimize size and give top performance. Ultrasonically bonded aluminum wires provide reliable interconnections at all operating temperatures. The CE, 8-pin TO-3 package is hermetically sealed and electrically isolated. The use of compressible thermal washers and/or improper mounting torque will void the product warranty. Please see "General Operating Considerations".

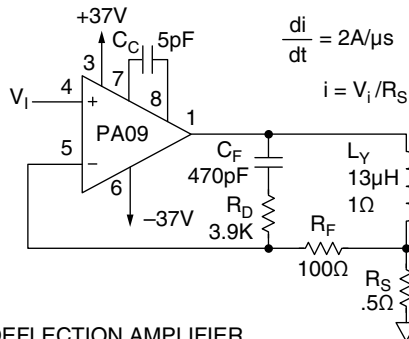

FIGURE 1. PA09 AS DEFLECTION AMPLIFIER



8-PIN TO-3 PACKAGE STYLE CE

DEFLECTION AMPLIFIER (FIGURE 1)

The deflection amplifier circuit of Figure 1 achieves arbitrary beam positioning for a fast heads-up display. Maximum transition times are 4μs while delivering 2A pk currents to the 13mH coil. The key to this circuit is the sense resistor (R_s) which converts yoke current to voltage for op amp feedback. This negative feedback forces the coil current to stay exactly proportional to the control voltage. The network consisting of R_D , R_F and C_F serves to shift from a current feedback via R_s to a direct voltage feedback at high frequencies. This removes the extra phase shift caused by the inductor thus preventing oscillation. See Application Note 5 for details of this and other precision magnetic deflection circuits.

EQUIVALENT SCHEMATIC

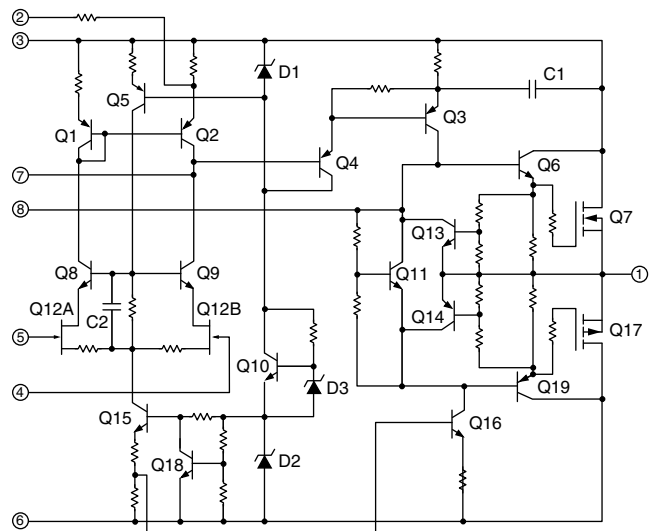

EXTERNAL CONNECTIONS

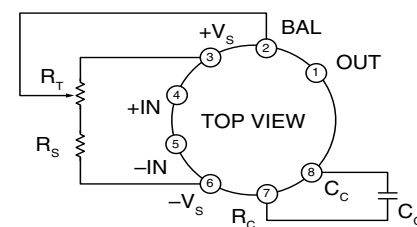

$$R_s = (|+V_s| + |-V_s|) R_T / 1.6$$

NOTE: Input offset voltage trim optional. $R_T = 10K\Omega$ MAX

PA09 • PA09A

ABSOLUTE MAXIMUM RATINGS SPECIFICATIONS

ABSOLUTE MAXIMUM RATINGS

SUPPLY VOLTAGE, $+V_S$ to $-V_S$	80V
OUTPUT CURRENT, within SOA	5A
POWER DISSIPATION, internal ¹	78W
INPUT VOLTAGE, differential	40V
INPUT VOLTAGE, common mode	$\pm V_S$
TEMPERATURE, pin solder - 10s	300°C
TEMPERATURE, junction ¹	150°C
TEMPERATURE RANGE, storage	-65 to +150°C
OPERATING TEMPERATURE RANGE, case	-55 to +125°C

SPECIFICATIONS

PARAMETER	TEST CONDITIONS ²	PA09			PA09A			UNITS
		MIN	TYP	MAX	MIN	TYP	MAX	
INPUT								
OFFSET VOLTAGE, initial	Full temperature range		.5	± 3		$\pm .25$	$\pm .5$	mV
OFFSET VOLTAGE, vs. temperature		10	30	5	10	$\mu\text{V}/^\circ\text{C}$		
OFFSET VOLTAGE, vs. supply		10	*	*	10	$\mu\text{V}/\text{V}$		
BIAS CURRENT, initial		5	100	3	20	pA		
BIAS CURRENT, vs. supply		.01	*	*	*	pA/V		
OFFSET CURRENT, initial		2.5	50	1.5	10	pA		
INPUT IMPEDANCE, DC		10^{11}	*	*	*	Ω		
INPUT CAPACITANCE		6	*	*	*	pF		
COMMON MODE VOLTAGE RANGE ³		Full temperature range	$\pm V_S - 10$	$\pm V_S - 8$	*	*	V	
COMMON MODE REJECTION, DC		Full temperature range, $V_{CM} = \pm 20\text{V}$		104	*	*	dB	
GAIN								
OPEN LOOP GAIN at 15Hz	$R_L = 1\text{k}\Omega$	80	98	*	*	dB		
GAIN BANDWIDTH PRODUCT at 1MHz	$C_C = 5\text{pF}$		150	*	*	MHz		
POWER BANDWIDTH	$R_L = 15\Omega, C_C = 5\text{pF}$		750	*	*	KHz		
POWER BANDWIDTH	$R_L = 15\Omega, C_C = 100\text{pF}$		150	*	*	KHz		
OUTPUT								
VOLTAGE SWING ³	Full temperature range, $I_O = 2\text{A}$	$\pm V_S - 8$	$\pm V_S - 7$	*	*	V		
CURRENT, PEAK			4.5	*	*	A		
SETTLING TIME to 1%	4V step, $C_C = 100\text{pF}$.75	*	*	μs		
SETTLING TIME to .1%	4V step, $C_C = 100\text{pF}$		1.3	*	*	μs		
SLEW RATE	$C_C = 5\text{pF}$		220	*	*	V/ μs		
SLEW RATE	$C_C = 100\text{pF}$		25	*	*	V/ μs		
RESISTANCE			7.5	*	*	Ω		
POWER SUPPLY								
VOLTAGE	Full temperature range	± 12	± 35	± 40	*	*	*	V
CURRENT, quiescent			70	85	*	*	*	mA
THERMAL								
RESISTANCE, AC junction to case ⁴	Full temperature range, $F > 60\text{Hz}$		1.2	1.3	*	*	*	$^\circ\text{C}/\text{W}$
RESISTANCE, DC junction to case	Full temperature range, $F < 60\text{Hz}$		1.6	1.8	*	*	*	$^\circ\text{C}/\text{W}$
RESISTANCE, junction to air	Full temperature range		30		*	*	*	$^\circ\text{C}/\text{W}$
TEMPERATURE RANGE, case	Meets full range specifications	-25	25	+ 85	*	*	*	$^\circ\text{C}$

NOTES: * The specification of PA09A is identical to the specification for PA09 in applicable column to the left.

1. Long term operation at the maximum junction temperature will result in reduced product life. Derate power dissipation to achieve high MTTF.
2. Unless otherwise noted: $T_C = 25^\circ\text{C}$, supply voltage = $\pm 35\text{V}$.
3. $+V_S$ and $-V_S$ denote the positive and negative supply rail respectively. Total V_S is measured from $+V_S$ to $-V_S$.
4. Rating applies if the output current alternates between both output transistors at a rate faster than 60Hz.

CAUTION

The internal substrate contains beryllia (BeO). Do not break the seal. If accidentally broken, do not crush, machine, or subject to temperatures in excess of 850°C to avoid generating toxic fumes.

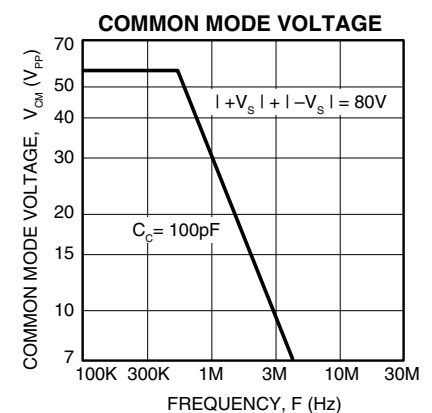
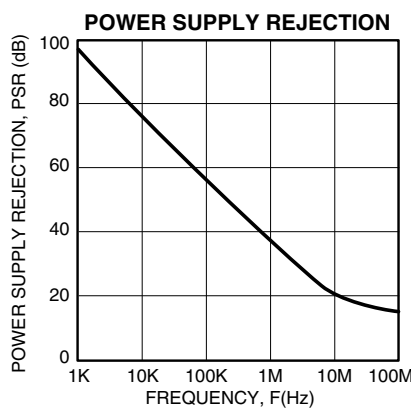
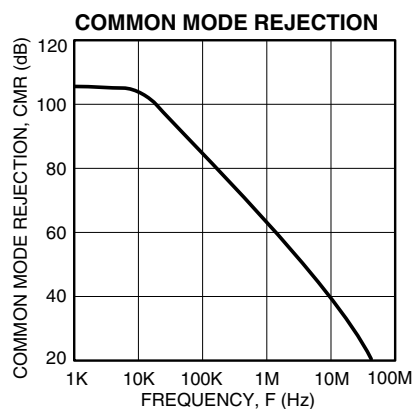
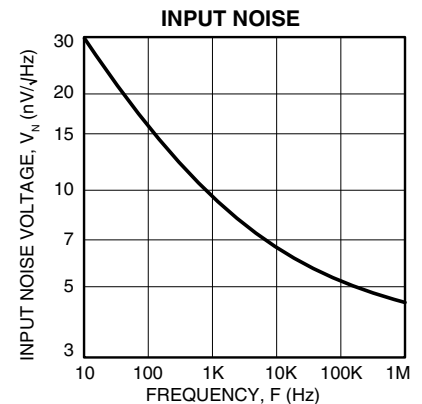
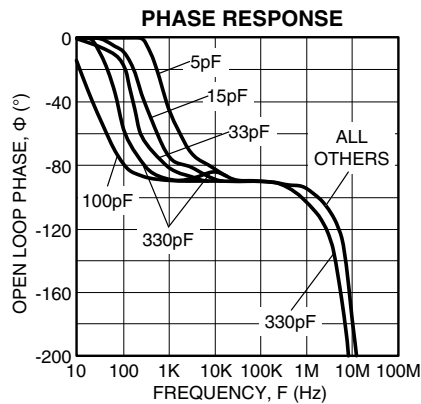
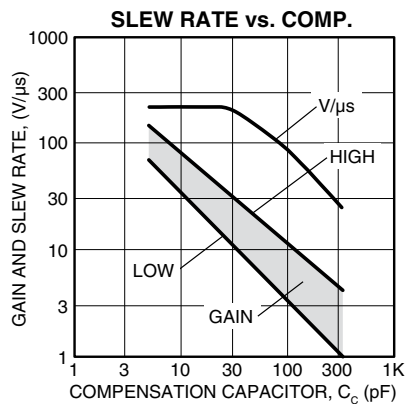
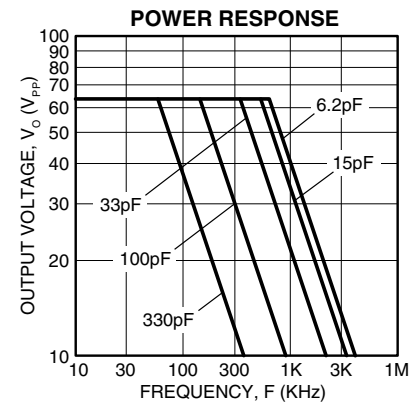
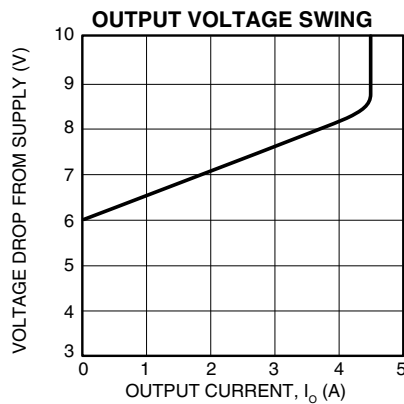
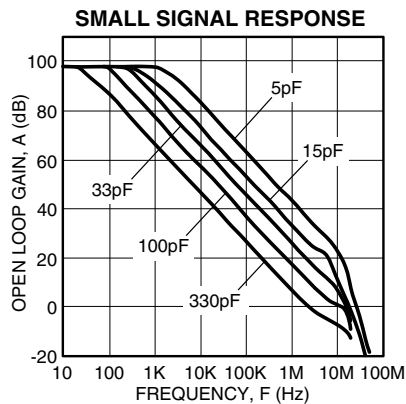
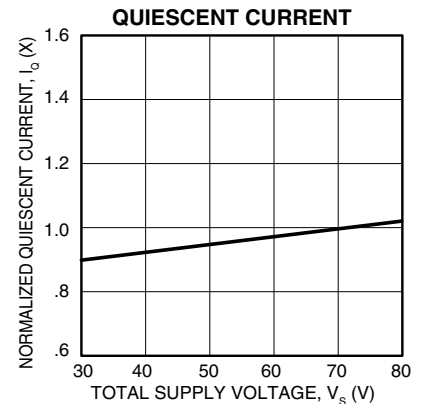
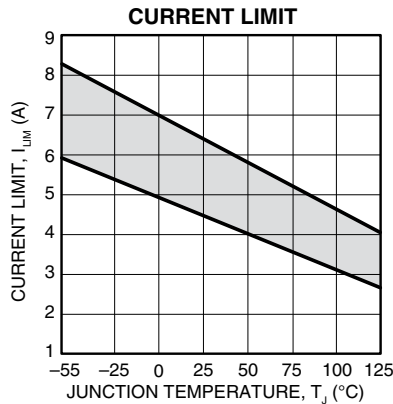
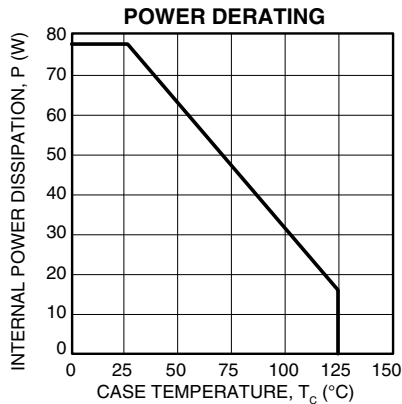

GENERAL

Please read Application Note 1 "General Operating Considerations" which covers stability, supplies, heat sinking, mounting, current limit, SOA interpretation, and specification interpretation. Visit www.apexmicrotech.com for design tools that help automate tasks such as calculations for stability, internal power dissipation, current limit; heat sink selection; Apex's complete Application Notes library; Technical Seminar Workbook; and Evaluation Kits.

SUPPLY VOLTAGE

The specified voltage ($\pm V_s$) applies for a dual (\pm) supply having equal voltages. A nonsymmetrical (ie. +70/-10V) or a single supply (ie. 80V) may be used as long as the total voltage between the $+V_s$ and $-V_s$ rails does not exceed the sum of the voltages of the specified dual supply.

SAFE OPERATING AREA (SOA)

The MOSFET output stage of this power operational amplifier has two distinct limitations:

1. The current handling capability of the MOSFET geometry and the wire bonds.
2. The junction temperature of the output MOSFETs.

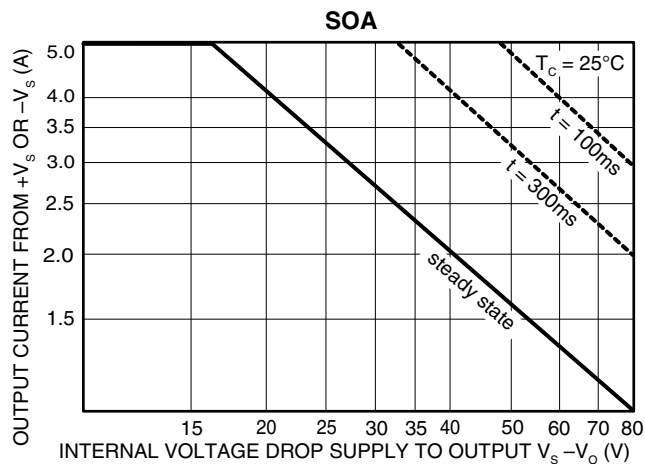

SAFE OPERATING AREA CURVES

The SOA curves combine the effect of these limits and allow for internal thermal delays. For a given application, the direction and magnitude of the output current should be calculated or measured and checked against the SOA curves. This is simple for resistive loads but more complex for reactive and EMF generating loads. The following guidelines may save extensive analytical efforts:

1. Capacitive and inductive loads up to the following maximums are safe:

$\pm V_s$	CAPACITIVE LOAD	INDUCTIVE LOAD
40V	.1 μ F	11mH
30V	500 μ F	24mH
20V	2500 μ F	75mH
15V	∞	100mH

2. Short circuits to ground are safe with dual supplies up to $\pm 20V$.
3. The output stage is protected against transient flyback. However, for protection against sustained, high energy flyback, external fast-recovery diodes should be used.

BYPASSING OF SUPPLIES

Each supply rail must be bypassed to common with a tantalum capacitor of at least 47 μ F in parallel with a .47 μ F ceramic capacitor directly connected from the power supply pins to the ground plane.

OUTPUT LEADS

Keep the output leads as short as possible. In the video frequency range, even a few inches of wire have significant inductance, raising the interconnection impedance and limiting the output current slew rate. Furthermore, the skin effect increases the resistance of heavy wires at high frequencies. Multistrand Litz Wire is recommended to carry large video currents with low losses.

GROUNDING

Single point grounding of the input resistors and the input signal to a common ground plane will prevent undesired current feedback, which can cause large errors and/or instabilities. "Single point" is a key phrase here; a ground plane should be used as shielding rather than a current path. Leaving the case of the PA09 floating will cause oscillations in some applications.

COMPENSATION

The PA09 is extremely flexible in terms of choice of compensation capacitor for any given gain. The most common ranges are shown in the COMPENSATION typical performance graph. Swinging closer to the supply rails, heavier loads, faster input signal rise and fall times and higher supply voltages all tend to demand larger values of compensation capacitor. This capacitor must be rated at least as high as the total voltage applied to the amplifier. In making specific value choices, use the square wave stability test presented in APPLICATION NOTE 19, Figures 40 and 41.

In addition to small signal testing, if the application includes step functions in the input signal, use this circuit to measure large signal response. By increasing square wave amplitude to the maximum of the application, this test may show significant distortion of the output waveform following the square wave transitions. In this case the faster input stages of the PA09 are out-running the output stage and overload recovery time creates the distortion. This speed relationship is also why slew rate does not increase for compensation values below about 27pF.

SUPPLY CURRENT

When swinging large signals, the output stage of the PA09 demands extra supply current. The following graphs illustrate this current for several conditions for both sine and square wave signals. Current is exclusive of any load current and will

affect both supply rating and thermal ratings. When calculating internal power dissipation, multiply this current times total supply voltage.

QUIESCENT vs. SINE DRIVE

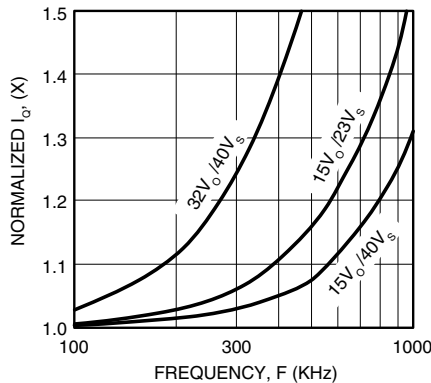

QUIESCENT vs. SQUARE DRIVE

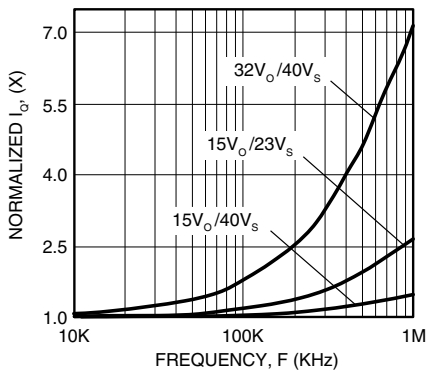

Note that swinging closer to the supply rail demands more current. Output voltage is given as peak. Currents are average responding supply readings, but AC monitoring will reveal current pulses corresponding to periods of high slew rate. For example, driving $\pm 30V$ outputs at 500KHz on $\pm 40V$ supplies produces a .8A pulse during negative slew and a 1.2A pulse during positive slew. If the input signal is over driven by several times the output swing capability, pulses up to 4A may be seen.

THERMAL SHUTDOWN PROTECTION

The thermal protection circuit shuts off the amplifier when the substrate temperature exceeds approximately $150^{\circ}C$. This allows heatsink selection to be based on normal operating conditions while protecting the amplifier against excessive junction temperature during temporary fault conditions.

Thermal protection is a fairly slow-acting circuit and therefore does not protect the amplifier against transient SOA violations (areas outside of the $T_c = 25^{\circ}C$ boundary). It is designed to protect against short-term fault conditions that result in high power dissipation within the amplifier, If the conditions that cause thermal shutdown are not removed, the amplifier will

oscillate in and out of shutdown. This will result in high peak power stresses, destroy signal integrity, and reduce the reliability of the device.

STABILITY

Due to its large bandwidth the PA09 is more likely to oscillate than lower bandwidth Power Operational Amplifiers. To prevent oscillations a reasonable phase margin must be maintained by:

1. Pay very careful attention to supply bypassing and circuit grounding. This is very important when step functions are driven and the PA09 shares supplies with more active devices.
2. Keeping the external sumpoint stray capacitance to ground at a minimum and the sumpoint load resistance (input and feedback resistors in parallel) below 500Ω . Larger sumpoint load resistances can be used with increased phase compensation and/or bypassing of the feedback resistor.
3. Connect the case to a local AC ground potential.

CURRENT LIMIT

Internal current limiting is provided in the PA09. Note the current limit curve given under typical performance graphs is based on junction temperature. If the amplifier is operated at cold junction temperatures, current limit could be as high as 8 amps. This is above the maximum allowed current on the SOA curve of 5 amps. Systems using this part must be designed to keep the maximum output current to less than 5 amps under all conditions. The internal current limit only provides this protection for junction temperatures of $80^{\circ}C$ and above.