



PCB Keyswitches

	Page
MICON 5 - Short-travel keyswitches NEW	4 - 3
MICON 5 - Short-travel keyswitches	4 - 4
MICON 5 - Plungers round, not illuminable	4 - 8
MICON 5 - Plungers square, illuminable	4 - 12
RACON - Short-travel keyswitches	4 - 17
RACON 8 - Short-travel keyswitch	4 - 18
RACON 12 - Short-travel keyswitch	4 - 22
RACON 12 V - Short-travel keyswitch with vertical adapter	4 - 26
RACON 12 i - Short-travel keyswitch	4 - 28
RACON - Special accessories	4 - 32
RK 90 II - Key cap system for RACON 12 with individual sealing NEW	4 - 36
RF - Short-travel keyswitches	4 - 39
RF 15 - Short-travel keyswitch	4 - 42
RF 15 N - Short-travel keyswitch	4 - 48
RF 15 R - Short-travel keyswitch	4 - 52
RF 15 H - Short-travel keyswitch	4 - 58
RF 15 - Signal indicator	4 - 62
RF 19 - Short-travel keyswitch	4 - 66
RF 19 H - Short-travel keyswitch	4 - 72
RF 19 - Signal indicator	4 - 76
RF 15/19 - Special accessories	4 - 80
KN 19 - Short-travel main switch	4 - 85
KN 19 - Short-travel main switch	4 - 86
RK 90 - Keycaps	4 - 89
RK 90 - Keycaps, plastic, 9 x 9 mm	4 - 92
RK 90 - Keycaps, plastic, 14 mm	4 - 94
RK 90 - Keycaps, aluminum, 14 x 14 mm	4 - 98
RK 90 - Special accessories	4 - 100
RG 85 III - Short-travel system	4 - 103
RG 85 III - Keyswitch	4 - 106
RG 85 III - Keylock switch	4 - 110
RG 85 III - Signal indicator, without lens	4 - 114
RG 85 III - Accessories	4 - 116
RS 76 - Full-travel keyswitches	4 - 125
RS 76 M - Full-travel keyswitch, not illuminable	4 - 132
RS 76 M - Full-travel keyswitch, illuminable	4 - 134
RS 76 C - Full-travel keyswitch, not illuminable	4 - 138
RS 76 C - Full-travel keyswitch, illuminable	4 - 140
RS 76 - Keycaps, not illuminable	4 - 142
RS 76 - Keycaps, illuminable	4 - 144
RS 76 - Keycaps, with legend, two-shot moulded/keycap sets	4 - 148
RS 76 - Accessories	4 - 150
Keylock and rotary switches for PCB	4 - 153
MICROMECH - Keylock switch IP54	4 - 154
EUROLOCKS - Keylock switch IP54	4 - 158
Priority keylock switch IP54	4 - 160
Rotary switch IP40	4 - 162
PCB Keyswitches	4 - 1

Examples for Applications Standards

MICON 5



CE-Conformity

The products of the Chapter "PCB Keyswitches" can – relating to the CE-conformity according to the Low-Voltage Directive 73/23/EWG – be divided into the following groups:

All products with an operating voltage $U_B > 50 V$

F. ex. Short-Travel Main Switch KN 19, for this product the Low-Voltage Directive 73/23/EWG applies.

All products with an operating voltage $U_B < 50 V$

F. ex. MICON, RACON, RF 15, RS 76, for these components no directive applies.

Single parts, accessories and illumination

No directive applies for these products.

EMC-Law

The components of this catalogue are within the meaning of the law concerning the electromagnetic conformity (= EMC-Law) "basic components as, for ex., switches, signal lamps or like" and, therefore, do not fall within the scope of the EMC-Law.

Declarations of Conformity

Declarations of conformity for all concerned products are available and can be delivered upon request. Please always state the exact order reference of the respective product.

Marking

The marking will be corresponding to the Low-Voltage Directive 73/23/EWG resp. the Directive "CE-Marking 93/68/EWG" either on the packing or on the product itself or on the shipping documents.

UL-approval

for MICON 5, RACON 8/12, Short-Travel Keyswitches RF 15/19

Data entry systems which are built with Rafi short-travel switches according to our design proposals meet the requirements of the UL approvals for the American market.

UL file no. for KN 19: E 116362
UL file no. for data entry systems: E 202520

RF 15



RG 85 III System



RF 15 with RK 90 System





General Data

Short-travel switch range MICON 5, with sealed contact system, clear key click and extremely reliable switching. Use under overlay or under keycaps RK 90. THT and SMT versions which can be mounted automatically.

Content

MICON 5 - Short-travel keyswitches NEW	4 - 4
MICON 5 - Short-travel keyswitch, SMT Standard	4 - 6
MICON 5 - Short-travel keyswitch, SMT low	4 - 7
MICON 5 - Short-travel keyswitch, THT Standard	4 - 7
MICON 5 - Plungers round, not illuminable NEW	4 - 8
MICON 5 - Plunger opaque, round, not illuminable	4 - 9
MICON 5 - Plungers square, illuminable NEW	4 - 12
MICON 5 - Plunger square, illuminable, 11 x 11 mm	4 - 13
MICON 5 - Plunger square, illuminable, 14.5 x 14.5 mm	4 - 14
MICON 5 - Plunger square, illuminable, 18 x 18 mm	4 - 15

NEW

MICON 5 - Short-travel keyswitches

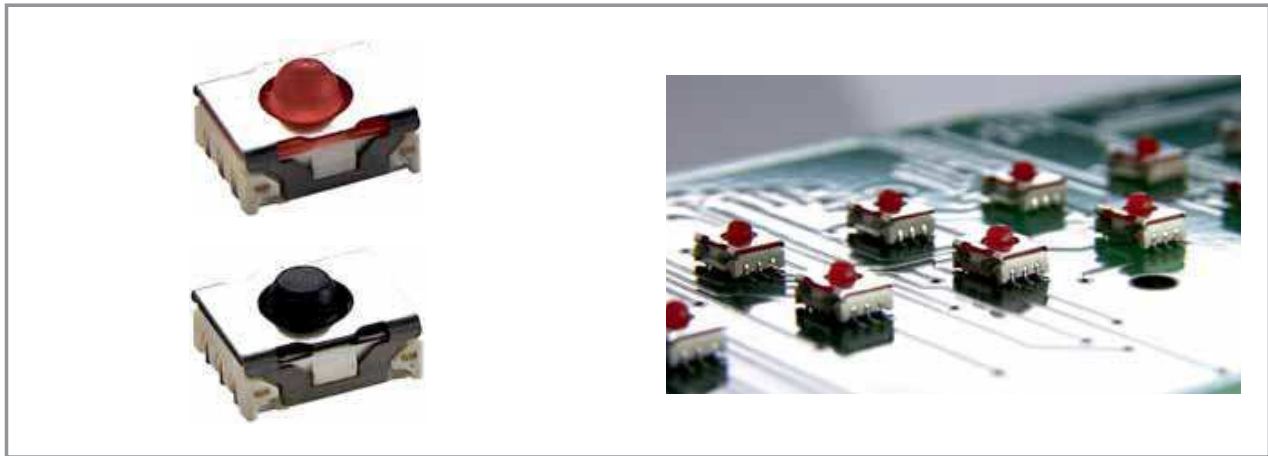

General Data

MICON 5 short-travel keyswitches offer an extremely high switching reliability while needing very little space. They can be arranged as single keys, in rows or key blocks. When arranged under an overlay, MICON keyswitches should be combined with plungers.

The features at a glance:

- Suitable for the most common soldering methods
 - Wave soldering bath for THT versions
 - Reflow soldering for SMT version
 - Vapour phase soldering for SMT versions
 - Manual soldering
- SMT version suitable for processing with an automatic SMT assembly machines
- IMDS listed

4

You can download actual product information from our internet site www.rafi.de / Catalogues and Downloads

Technical Data

MICON

Dimensions

Length of housing	6.4 mm
Width of housing	5.1 mm
Overall height	see order block

Mechanical design

Mounting	soldering
Terminals	see order block
Contact system	snap-action contact
Contact arrangement	1 NO
Contact materials	Au
Illumination	no

Mechanical characteristics

Operating force F1 ($\pm 20\%$)	see order block
Switching travel S2 (± 0.15 mm)	see order block

Electrical characteristics

Rated voltage min.	0.02 V
Rated voltage max.	35 V

Rated current min.	0.01 mA
Rated current max.	100 mA
Rated power max. (ohmic load)	1 W
Contact resistance when new	100 m Ω
Rated voltage resistance AC	250 V
Insulation resistance	10 ⁹ Ω

Other specifications

Ambient temp. operating min.	-40 °C
Ambient temp. operating max.	+90 °C
Resistance to environment	IEC 60068-2 -14, -30, -33, -78
Operating life (test force)	see order block
Solder heat resistance / Solderability	see order block
Flammability of materials	UL 94 V1
Packing	see order block
Produkt code	see order block

MICON 5 Circuit Diagram

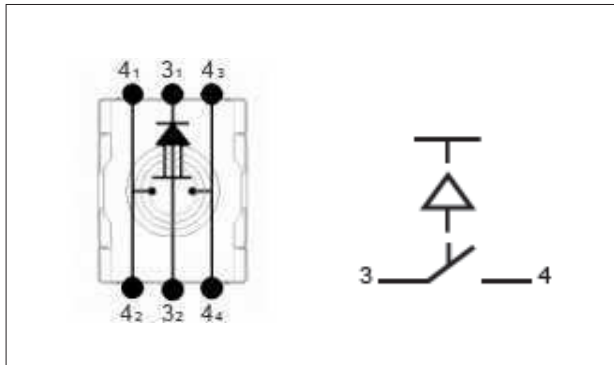

MICON 5 Force-Travel Diagram

Operating force F_1 : see order block
Switching travel S_2 : see order block

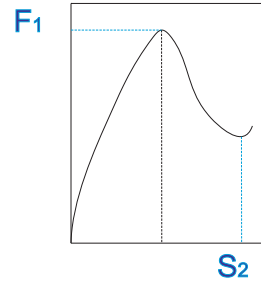

MICON 5 Product Code acc. to DIN EN ISO 9001 (EN ISO 8402)

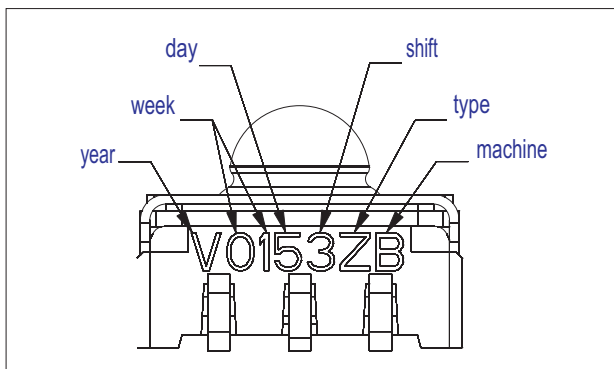

Traceability acc. to (EN ISO 8402) DIN EN ISO 9001, 2000, 7.5.3
A 7-digit code is printed on the housing of the keyswitch. This code informs about production date, production shift and type of product.

MICON 5 SMT Version, Tape and Reel Drawing

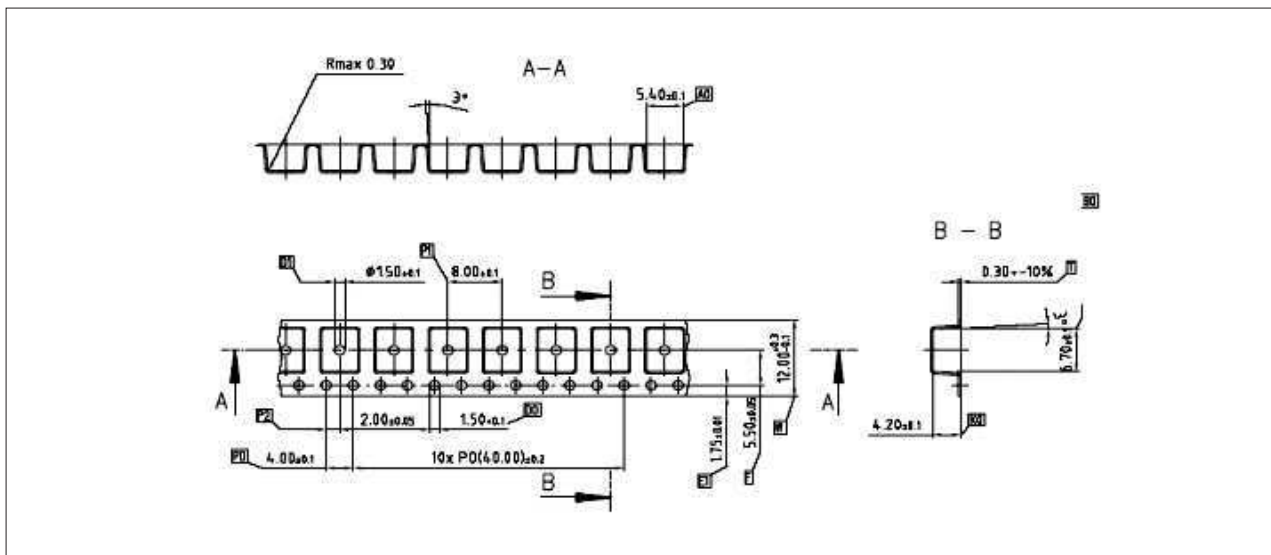

NEW

MICON 5 - Short-travel keyswitch, SMT Standard

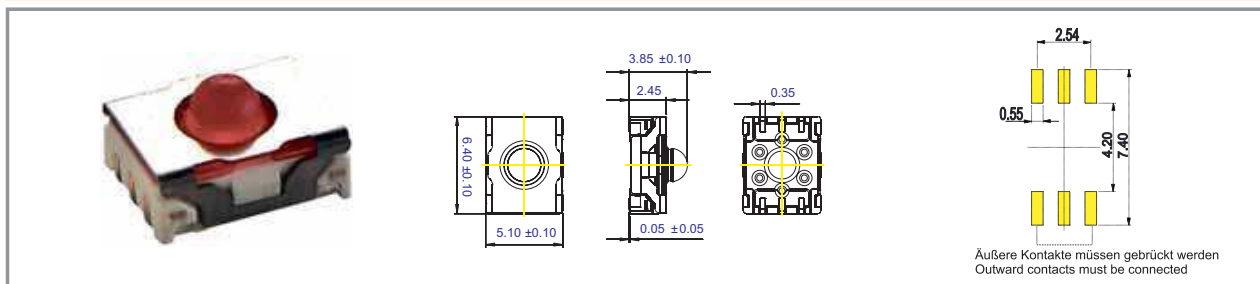

Terminals	Solder heat resistance / Solderability	Operating force F1 (±20%)	Switching travel S2 (±0,15 mm)	Operating life (test force)	Produkt code	Order no.
SMT	E DIN IEC 600 68-2-58	3.0 N	0.7 mm	1,000,000 (4 N)	X	1.14.002.101/0000
SMT	E DIN IEC 600 68-2-58	4.5 N	0.8 mm	250,000 (6 N)	Z	1.14.002.001/0000
SMT	E DIN IEC 600 68-2-58	5.5 N	0.9 mm	1,000,000 (8 N)	W	1.14.002.111/0000
SMT	E DIN IEC 600 68-2-58	8.0 N	1.1 mm	250,000 (12 N)	Y	1.14.002.011/0000

Technical data see page 4 - 4

Packing: in tape, reel with 2100 pieces
Keycaps see RK 90

Mounting hints:

Special pipette (Siemens Siplace order no.: 348514-02), mounting with collect and place head
Recommendation for screen printing: 150 µm stencil with 10% reduction of the pad size.

4

MICON

MICON 5 - Short-travel keyswitch, SMT low

NEW

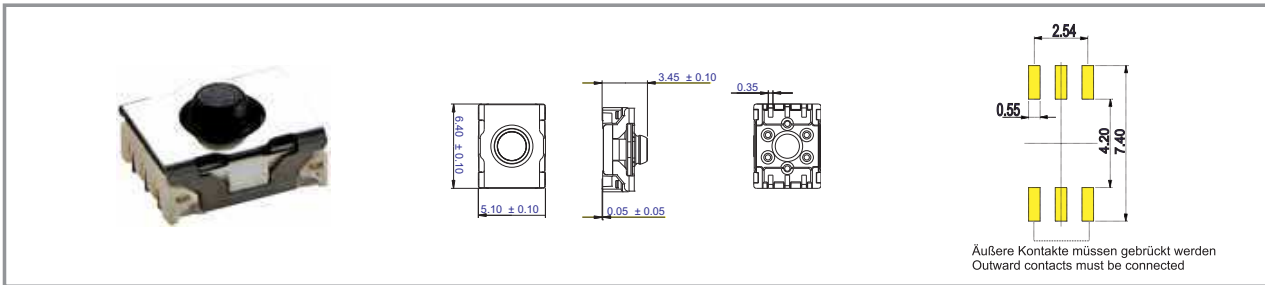

Terminals	Solder heat resistance / Solderability	Operating force F1 (±20%)	Switching travel S2 (±0,15 mm)	Operating life (test force)	Produkt code	Order no.
SMT	E DIN IEC 600 68-2-58	3.0 N	0.6 mm	1,000,000 (4 N)	S	1.14.002.103/0000
SMT	E DIN IEC 600 68-2-58	4.5 N	0.7 mm	250,000 (6 N)	T	1.14.002.003/0000
SMT	E DIN IEC 600 68-2-58	5.5 N	0.7 mm	1,000,000 (8 N)	R	1.14.002.113/0000

Technical data see page 4 - 4

Packing: in tape, reel with 2100 pieces
Keycaps see RK 90

Mounting hints:

Special pipette (Siemens Siplace order no.: 348514-02), mounting with collect and place head
Recommendation for screen printing: 150 µm stencil with 10% reduction of the pad size.

MICON 5 - Short-travel keyswitch, THT Standard

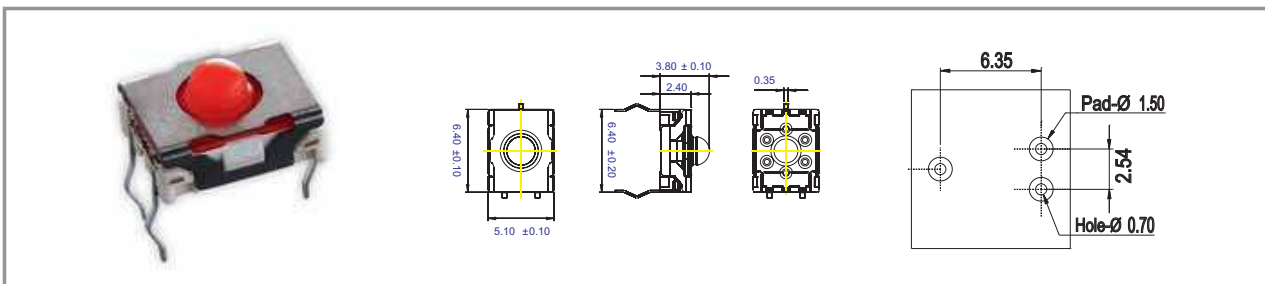

Terminals	Solder heat resistance / Solderability	Operating force F1 (±20%)	Switching travel S2 (±0,15 mm)	Operating life (test force)	Produkt code	Order no.
THT	E DIN IEC 600 68-2-20	3.0 N	0.7 mm	1,000,000 (4 N)	O	1.14.002.106/0000
THT	E DIN IEC 600 68-2-20	4.5 N	0.8 mm	250,000 (6 N)	Q	1.14.002.006/0000
THT	E DIN IEC 600 68-2-20	5.5 N	0.9 mm	1,000,000 (8 N)	N	1.14.002.116/0000
THT	E DIN IEC 600 68-2-20	8.0 N	1.1 mm	250,000 (12 N)	P	1.14.002.016/0000

Technical data see page 4 - 4

Packing: in tubes with 102 pieces
Keycaps see RK 90

4

MICON

NEW

NEW

MICON 5 - Plungers round, not illuminable

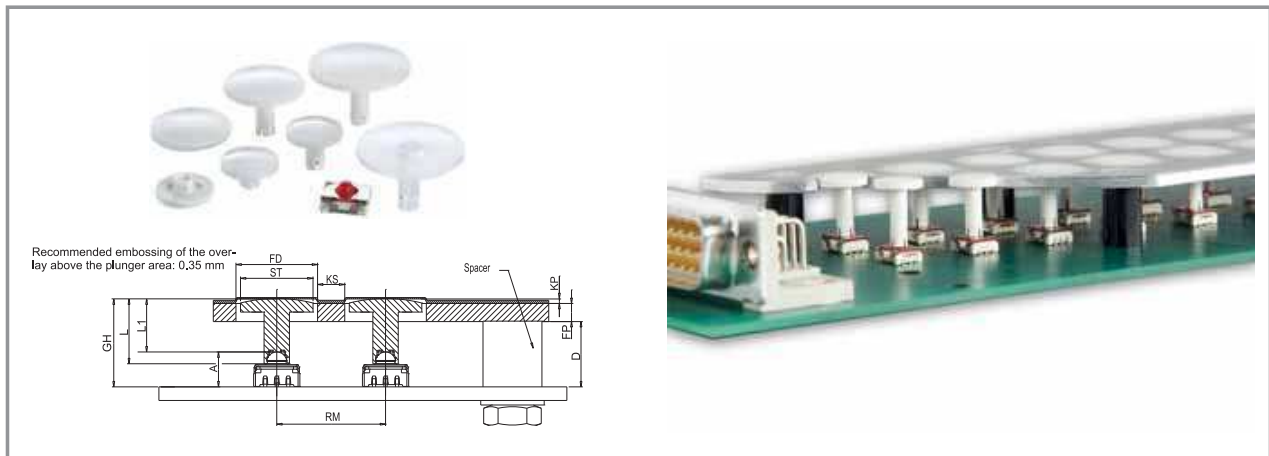

General Data

- A - Height of keyswitch: SMT type: 3.85 mm, THT type: 3.80 mm
 - D - Length of spacer $D = GH - KP - FP$
 - FD - Front panel cut-out $FD = ST + 1 \text{ mm}$
 - FP - Front panel thickness
 - GH - Overall height: $GH = A + L1 + 0.05$ (SMT type), $GH = A + L1$ (THT type)
 - KP - Thickness of overlay + embossing
 - KS - Glue webs for overlay, min. 3 mm
 - L1 - Length of plunger above keyswitch $L1 = GH - A$
 - L - Overall length of plunger $L = L1 + 1.3 \text{ mm}$ (min. 3 mm)
 - RM - Key grid $RM = FD + KS$
 - ST - Diameter of plunger
- The plungers can only be combined with MICON 5 version Standard (red bubble).

4

Technical Data

General information

Plunger diameter/size	see order block
Length of plunger L	see order block

MICON

MICON 5 - Plunger opaque, round, not illuminable

NEW

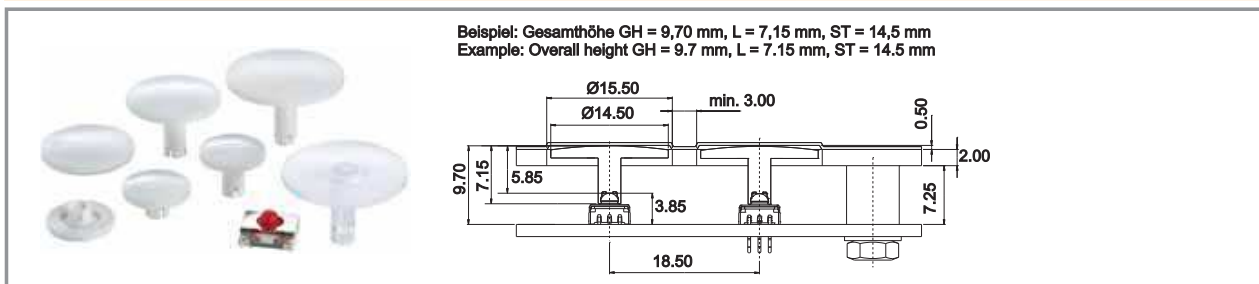

Plunger diameter ST/size	Length of plunger L	Order no.
6.0 mm	3.00 mm	5.46.001.103/0200
6.0 mm	3.45 mm	5.46.001.104/0200
6.0 mm	3.95 mm	5.46.001.105/0200
6.0 mm	4.45 mm	5.46.001.106/0200
6.0 mm	7.15 mm	5.46.001.107/0200
6.0 mm	9.95 mm	5.46.001.108/0200
8.0 mm	3.00 mm	5.46.001.123/0200
8.0 mm	3.45 mm	5.46.001.124/0200
8.0 mm	3.95 mm	5.46.001.125/0200
8.0 mm	4.45 mm	5.46.001.126/0200
8.0 mm	5.50 mm	5.46.001.121/0200
8.0 mm	7.15 mm	5.46.001.127/0200
8.0 mm	9.95 mm	5.46.001.128/0200
8.0 mm	10.30 mm	5.46.001.122/0200
11.5 mm	3.00 mm	5.46.001.143/0200
11.5 mm	3.45 mm	5.46.001.144/0200
11.5 mm	3.95 mm	5.46.001.145/0200
11.5 mm	4.45 mm	5.46.001.146/0200
11.5 mm	5.50 mm	5.46.001.141/0200
11.5 mm	7.15 mm	5.46.001.147/0200
11.5 mm	9.95 mm	5.46.001.148/0200
11.5 mm	10.30 mm	5.46.001.142/0200

4
MICON

Plunger diameter ST/size	Length of plunger L	Order no.
14.5 mm	3.00 mm	5.46.001.163/0200
14.5 mm	3.45 mm	5.46.001.164/0200
14.5 mm	3.95 mm	5.46.001.165/0200
14.5 mm	4.45 mm	5.46.001.166/0200
14.5 mm	7.15 mm	5.46.001.167/0200
14.5 mm	9.95 mm	5.46.001.168/0200
19.0 mm	3.00 mm	5.46.001.183/0200
19.0 mm	3.45 mm	5.46.001.184/0200
19.0 mm	3.95 mm	5.46.001.185/0200
19.0 mm	4.45 mm	5.46.001.186/0200
19.0 mm	7.15 mm	5.46.001.187/0200
19.0 mm	9.95 mm	5.46.001.188/0200

Technical data see page 4 - 8

Can only be combined with MICON 5 version Standard (red bubble)

4

MICON



MICON 5: Just feel it.



AUTOMOTIVE



**INSTRUMENTATION-CONTROL-
AUTOMATION**



MEDICAL TECHNOLOGY

There is no miniature key-switch which has a better tactile and acoustic feedback than the new RAFI MICON 5 short-travel keyswitch.

The little one shows its excellence under keycaps, membrane overlays or elastic seals. Outstanding tactile feedback and absolutely

reliable switching behaviour in demanding applications, including hostile environments. MICON 5 – test it!

For samples and information, please contact: info@rafi.de

RAFI GmbH & Co. KG
 D-88276 Berg/Ravensburg
 Phone: +49 751 89-0, Fax: +49 751 89-13 00
www.rafi.de, info@rafi.de

RAFI
 SOLUTIONS WITH PASSION

NEW

MICON 5 - Plungers square, illuminable

Musteraufbau, MICON 5 mit quadratischem Stößel, GH = 9.7 mm
Sample assembly, MICON 5 with square plunger, GH = 9.7 mm

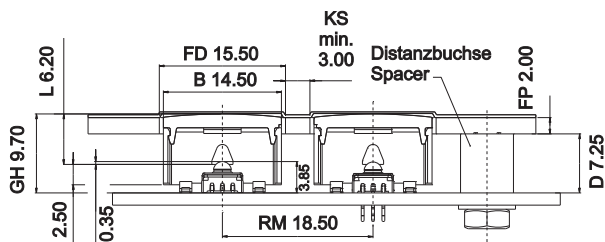

General Data

Description

A - Height of keyswitch: SMT = 3.85 mm, THT = 3.80 mm

B - Width of plunger (11 x 11 mm, 14,5 x 14,5 mm or 18 x 18 mm)

D - GH - FP - 0.5 mm (= embossing height 0.35 mm + glue height 0.15 mm)

FD - Front panel cut-out: B + 1 mm

FP - Thickness of front plate

GH - Overall height: A + 5.75 mm

KS - Glue strip min. 3 mm

R - Grid size: FD + KS

The plungers can only be combined with MICON 5 version Standard (red bubble).

4

Technical Data

General information

Overall height GH

see order block

Colour of lens

see order block

MICON

MICON 5 - Plunger square, illuminable, 11 x 11 mm

NEW



Overall height GH	Colour of lens	Order no.
9.70 mm	red	5.05.511.470/2300
9.70 mm	green	5.05.511.470/2500
9.70 mm	yellow	5.05.511.470/2400
9.70 mm	white	5.05.511.470/2200
9.70 mm	blue	5.05.511.470/2600
12.50 mm	red	5.05.511.471/2300
12.50 mm	green	5.05.511.471/2500
12.50 mm	yellow	5.05.511.471/2400
12.50 mm	white	5.05.511.471/2200
12.50 mm	blue	5.05.511.471/2600
12.50 mm	opaque blue	5.05.511.476/0600

Technical data see page 4 - 12

Can only be combined with MICON 5 version Standard (red bubble)

4

MICON

NEW

MICON 5 - Plunger square, illuminable, 14.5 x 14.5 mm



Pic. with 4 LED OSRAM LO M676-Q1R1-24

Overall height GH	Colour of lens	Order no.
9.70 mm	red	5.05.511.475/2300
9.70 mm	green	5.05.511.475/2500
9.70 mm	yellow	5.05.511.475/2400
9.70 mm	white	5.05.511.475/2200
9.70 mm	blue	5.05.511.475/2600
12.50 mm	red	5.05.511.476/2300
12.50 mm	green	5.05.511.476/2500
12.50 mm	yellow	5.05.511.476/2400
12.50 mm	white	5.05.511.476/2200
12.50 mm	blue	5.05.511.476/2600

4

Technical data see page 4 - 12

Can only be combined with MICON 5 version Standard (red bubble)

MICON

MICON 5 - Plunger square, illuminable, 18 x 18 mm

NEW



Pic. with 6 LED OSRAM LO M676-Q1R1-24

Overall height GH	Colour of lens	Order no.
9.70 mm	red	5.05.511.480/2300
9.70 mm	green	5.05.511.480/2500
9.70 mm	yellow	5.05.511.480/2400
9.70 mm	white	5.05.511.480/2200
9.70 mm	blue	5.05.511.480/2600
12.50 mm	red	5.05.511.481/2300
12.50 mm	green	5.05.511.481/2500
12.50 mm	yellow	5.05.511.481/2400
12.50 mm	white	5.05.511.481/2200
12.50 mm	blue	5.05.511.481/2600

Technical data see page 4 - 12

Can only be combined with MICON 5 version Standard (red bubble)

4

MICON

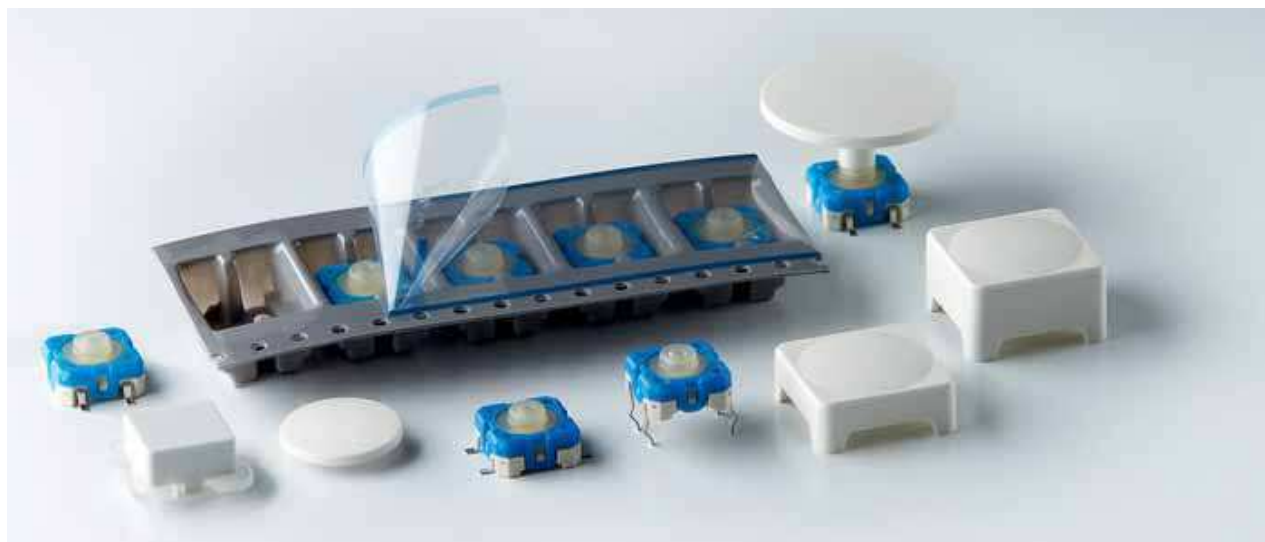

General Data

RACON short-travel keyswitches with sealed contact system and distinct key click, excellent switching reliability. For use under an overlay or with RK 90 keycaps. Print and SMD versions available (suitable for automatic assembly).

Content

RACON 8 - Short-travel keyswitch	4 - 18
RACON 8 - Short-travel keyswitch, THT outward	4 - 20
RACON 8 - Short-travel keyswitch, THT inward	4 - 20
RACON 8 - Short-travel keyswitch, SMT gullwing (Z) terminals	4 - 21
RACON 12 - Short-travel keyswitch	4 - 22
RACON 12 - Short-travel keyswitch solder terminals for PCB, outward	4 - 24
RACON 12 - Short-travel keyswitch solder terminals for PCB, inward	4 - 25
RACON 12 - Short-travel keyswitch SMT gullwing (Z) terminals	4 - 25
RACON 12 V - Short-travel keyswitch with vertical adapter	4 - 26
RACON 12 V - Short-travel keyswitch with vertical adapter	4 - 27
RACON 12 i - Short-travel keyswitch	4 - 28
RACON 12 i - Short-travel keyswitch	4 - 30
RACON - Special accessories	4 - 32
Plunger round	4 - 32
Square plunger for membrane data entry system	4 - 34
RK 90 II - Key cap system for RACON 12 with individual sealing NEW	4 - 36
RK 90 II - Sealing frame	4 - 37

RACON 8 - Short-travel keyswitch

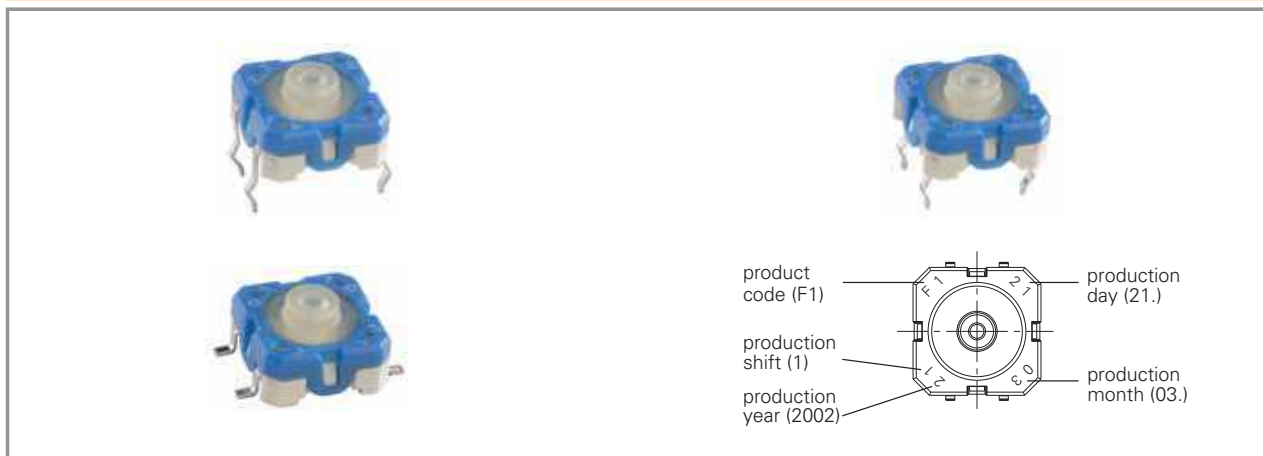

General Data

RACON 8 short-travel keyswitches offer an extremely high switching reliability while needing very little space. They can be arranged as single keys, in rows or key blocks. When arranged under an overlay, RACON keyswitches should be combined with plungers.

The features at a glance:

- Suitable for the most common soldering methods
 - Wave soldering bath for THT versions
 - Reflow soldering for SMT version
 - Vapour phase soldering for SMT versions
 - Manual soldering
- SMT version suitable for processing with an automatic SMT assembly machine
- IMDS listed

You can download actual product information from our internet site www.rafi.de / Catalogues and Downloads

4

Technical Data

RACON

Dimensions			
Length of housing	8.4 mm	Rated current min.	0.01 mA
Width of housing	8.4 mm	Rated current max.	100 mA
Height of housing	see order block	Rated power max.	1 W
		(ohmic load)	
		Contact resistance when new	100 mΩ
		max.	
Mechanical design		Insulation resistance	10 ⁹ Ω
Mounting	soldering	Other specifications	
Terminals	see order block	Ambient temp. operating min.	-40 °C
Contact system	snap-action contact	Ambient temp. operating max.	+90 °C
Contact arrangement	1 NO	Resistance to environment	DIN EN 60068-2 -14, -30, -33 and -78
Contact materials	Au	Operating life	1,000,000
Illumination	no	Solderability / Solder heat	see order block
		resistance	
Mechanical characteristics		Flammability of materials	UL 94 HB
Operating force	3.3±0.6 N	Packing	see order block
Switching travel	0.34±0.1 mm	Produkt code	see order block
Electrical characteristics			
Rated voltage min.	0.02 V		
Rated voltage max.	35 V		

RACON 8, Typical System Assembly with Plunger under Overlay

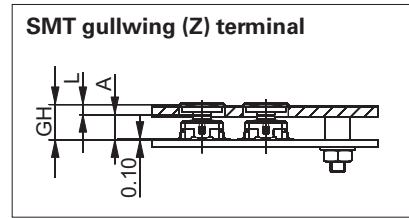
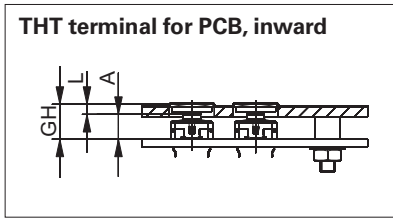
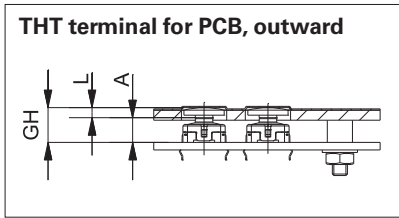

Variable	Declaration	THT terminal outward	THT terminal inward	SMT-terminal
A	Height of keyswitch		A = 4.90 +/- 0.1 mm	
GH	Overall height		GH = A + L	GH = A + L + 0.1 mm
L	Length of plunger		L = GH - A	L = GH - A - 0.1 mm

RACON 8, PCB Hole Pattern, Smallest Grid

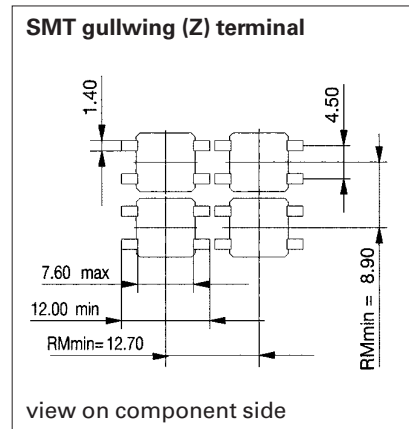
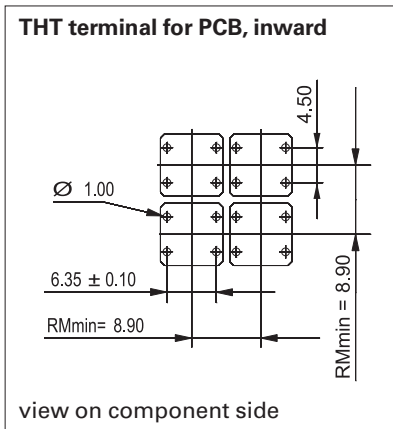
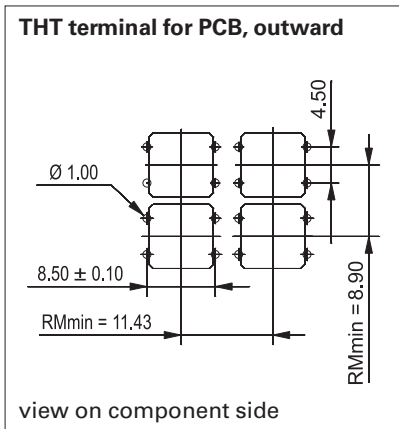

4

RACON 8, SMT Terminal, Tape and Reel Drawing

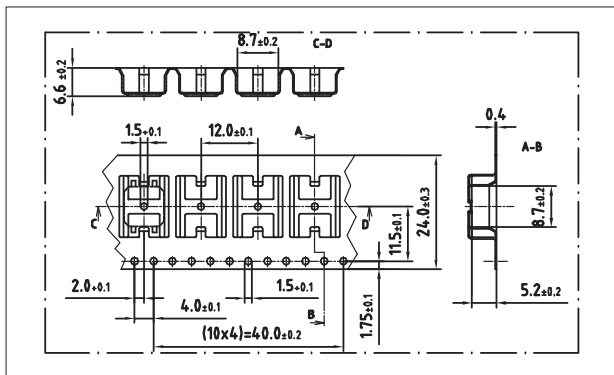

Circuit Diagram Typical Force-Travel Diagram

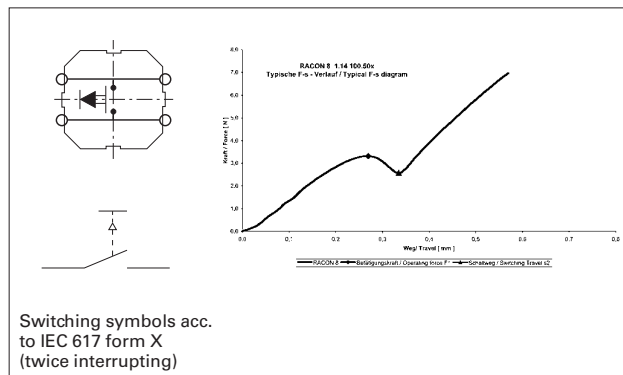

RACON

Typical accessories RACON 8 - Short-travel keyswitch

Description	Photo	Order no.	Additional accessories see page
Spacer, round, length 6.25 mm, red		5.30.759.034/0000	2 - 239, 4 - 82, 5 - 30
Plunger round		5.46.167.311/0209	4 - 32
RK 90 - Keycap body, for lenses 9 x 9 mm		5.55.103.265/1013	4 - 93

For other plungers, refer to the chapter „RACON special accessories“; for keycaps, refer to the chapter „RK 90“.

RACON 8 - Short-travel keyswitch, THT outward

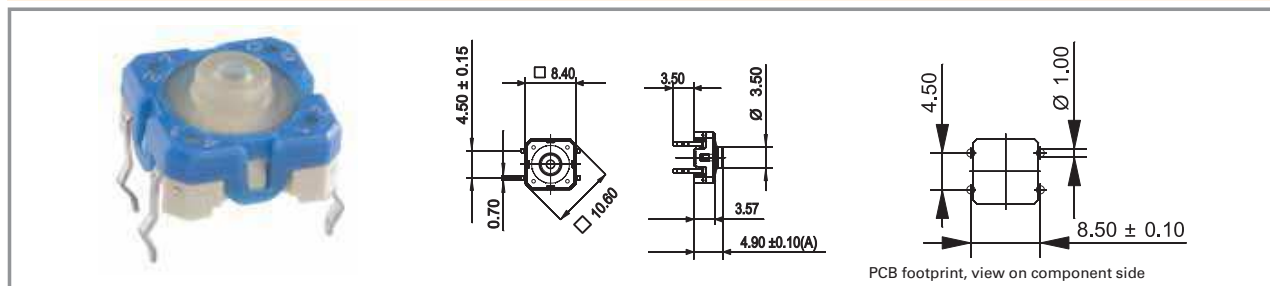

Terminals	Operating force	Solderability / Solder heat resistance	Produkt code	Packing	Order no.
THT outward	3.3±0.6 N	E DIN IEC 600 68-2-20	A1	tubes à 60 piece	1.14.100.501/0000

Technical data see page 4 - 18

For keycaps refer to chapter „RK 90“, plungers see „RACON special accessories“

4

RACON 8 - Short-travel keyswitch, THT inward

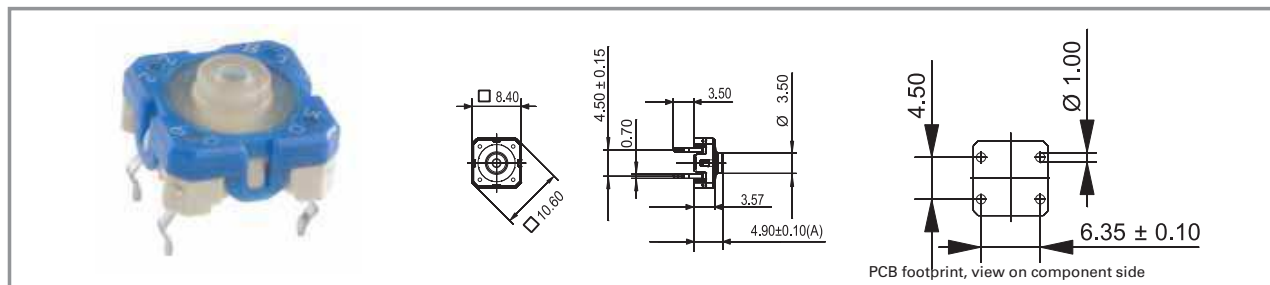

Terminals	Operating force	Solderability / Solder heat resistance	Produkt code	Packing	Order no.
THT inward	3.3±0.6 N	E DIN IEC 600 68-2-20	B1	tubes à 60 piece	1.14.100.502/0000

Technical data see page 4 - 18

For keycaps refer to chapter „RK 90“, plungers see „RACON special accessories“

RACON

RACON 8 - Short-travel keyswitch, SMT gullwing (Z) terminals

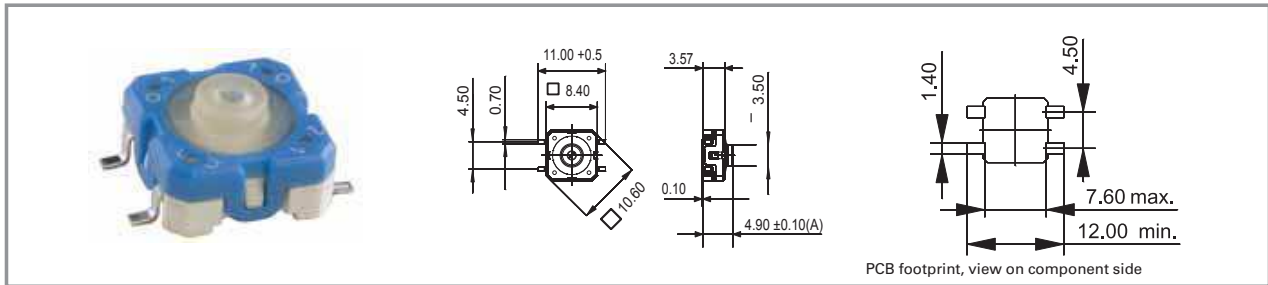

Terminals	Operating force	Solderability / Solder heat resistance	Produkt code	Packing	Order no.
SMT Gullwing (Z) terminals	3.3±0.6 N	E DIN IEC 600 68-2-58	C1	tape and reel à 1000 pieces	1.14.100.503/0000

Technical data see page 4 - 18

For keycaps refer to chapter „RK 90“, plungers see „RACON special accessories“

RACON 12 - Short-travel keyswitch

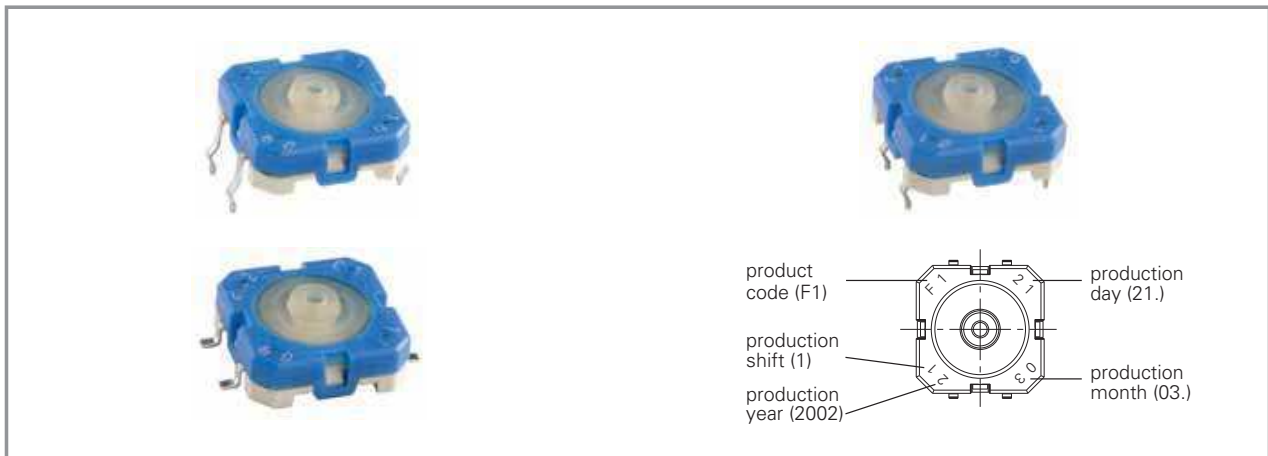

General Data

RACON 12 short-travel keyswitches offer an extremely high switching reliability while needing very little space. They can be arranged as single keys, in rows or key blocks. When arranged under an overlay, RACON keyswitches should be combined with plungers.

The features at a glance:

- Suitable for the most common soldering methods
 - Wave soldering bath for THT versions
 - Reflow soldering for SMT versions
 - Vapour phase soldering for SMT versions
 - Manual soldering
- SMT version suitable for processing with an automatic SMT assembly machine
- IMDS listed

4

Technical Data

RACON	Dimensions				
	Length of housing	12 mm	Rated current min.	0.01 mA	
	Width of housing	12 mm	Rated current max.	100 mA	
	Overall height	see order block	Rated power max. (ohmic load)	1 W	
			Contact resistance when new max.	100 mΩ	
	Mechanical design		Insulation resistance	10 ⁹ Ω	
	Mounting	soldering	Other specifications		
	Terminals	see order block	Ambient temp. operating min.	-40 °C	
	Contact system	snap-action contact	Ambient temp. operating max.	+90 °C	
	Contact arrangement	1 NO	Resistance to environment	DIN EN 60068-2 -14, -30,-33 and -78	
Contact materials	Au	Operating life	1,000,000		
Illumination	no	Solderability / Solder heat resistance	see order block		
Mechanical characteristics		Flammability of materials	UL 94 HB		
Operating force	see order block	Packing	see order block		
Switching travel	see order block	Produkt code	see order block		
Electrical characteristics					
Rated voltage min.	0.02 V				
Rated voltage max.	35 V				

RACON 12, Typical System Assembly with Plunger under Overlay

THT terminal for PCB, outward

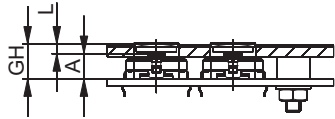

THT terminal for PCB, inward

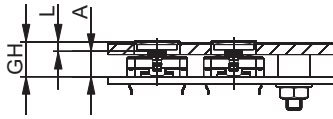

SMT gullwing (Z) terminal

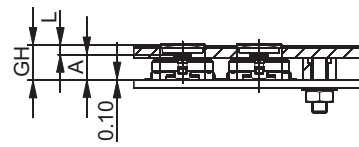

Variable	Declaration	THT terminal outward	THT terminal inward	SMT-terminal
A	Height of keyswitch		$A = 4.95 \pm 0.1 \text{ mm}$	
GH	Overall height		$GH = A + L$	$GH = A + L + 0.1 \text{ mm}$
L	Length of plunger		$L = GH - A$	$L = GH - A - 0.1 \text{ mm}$

RACON 12, PCB Hole Pattern, Smallest Grid

THT terminal for PCB, outward

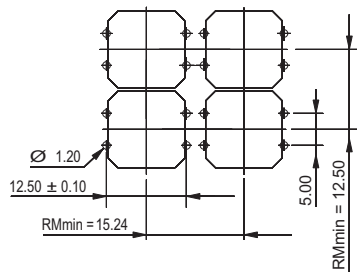

view on component side

THT terminal for PCB, inward

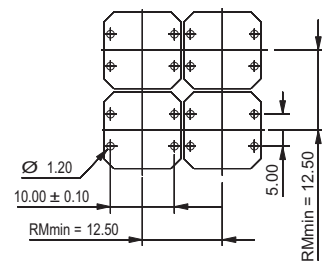

view on component side

SMT gullwing (Z) terminal

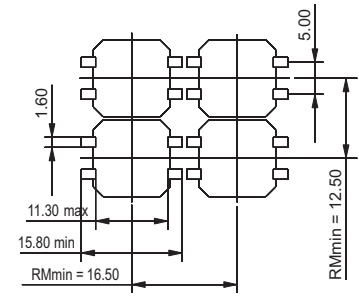

view on component side

4

RACON 12, SMT Terminal, Tape and Reel Drawing

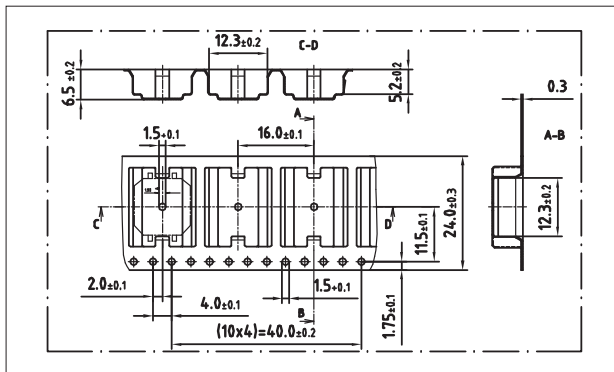

Circuit Diagram RACON 12

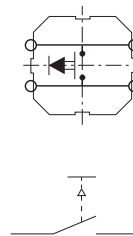

Switching symbols acc. to IEC 617 form X (twice interrupting)

Typical Force-Travel Diagram

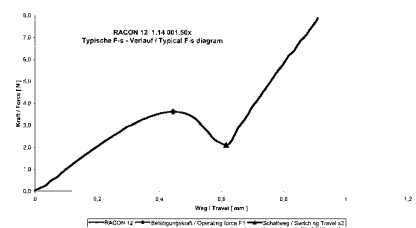

Typical accessories RACON 12 - Short-travel keyswitch

Description	Photo	Order no.	Additional accessories see page
Spacer, round, length 6.25 mm, red		5.30.759.034/0000	2 - 239, 4 - 82, 5 - 30
Square plunger for membrane data entry system		5.46.001.057/0209	4 - 34
Plunger round		5.46.168.050/0209	4 - 33
RK 90 - Keycap body, for lens 1 -module		5.55.103.030/1013	4 - 95

For other plungers, refer to the chapter „RACON special accessories“; for keycaps, refer to the chapter „RK 90“

RACON 12 - Short-travel keyswitch solder terminals for PCB, outward

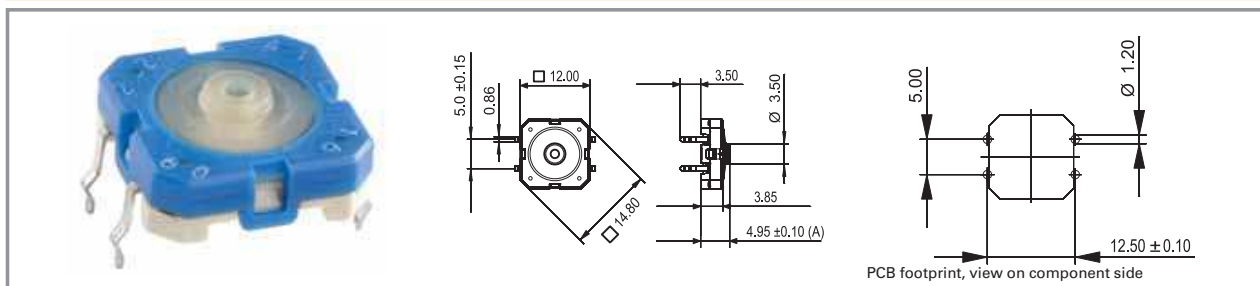

Terminals	Operating force	Switching travel	Solderability / Solder heat resistance	Produkt code	Packing	Order no.
THT outward	3.6±0.7 N	0.61±0.1 mm	E DIN IEC 600 68-2-20	A1	tubes à 45 pieces	1.14.001.501/0000

Technical data see page 4 - 22

For keycaps refer to chapter „RK 90“, plungers see „RACON special accessories“

4

RACON

RACON 12 - Short-travel keyswitch solder terminals for PCB, inward

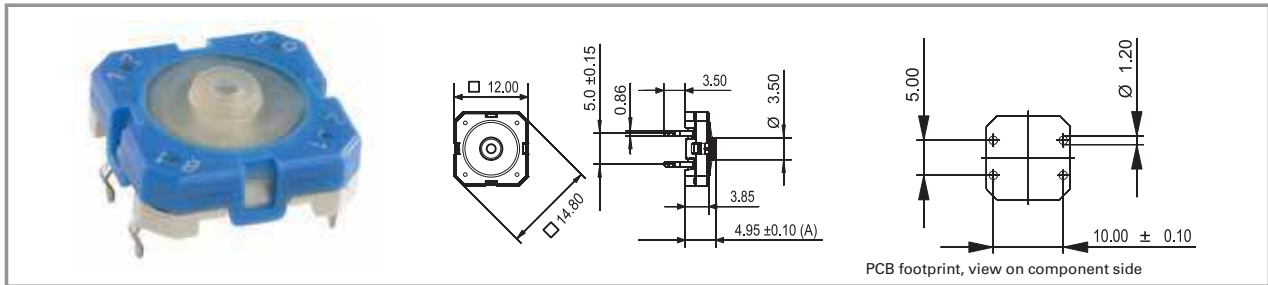

Terminals	Operating force	Switching travel	Solderability / Solder heat resistance	Produkt code	Packing	Order no.
THT outward	3.6±0.7 N	0.61±0.1 mm	E DIN IEC 600 68-2-20	B1	tubes à 45 pieces	1.14.001.502/0000

Technical data see page 4 - 22

For keycaps refer to chapter „RK 90“, plungers see „RACON special accessories“

RACON 12 - Short-travel keyswitch SMT gullwing (Z) terminals

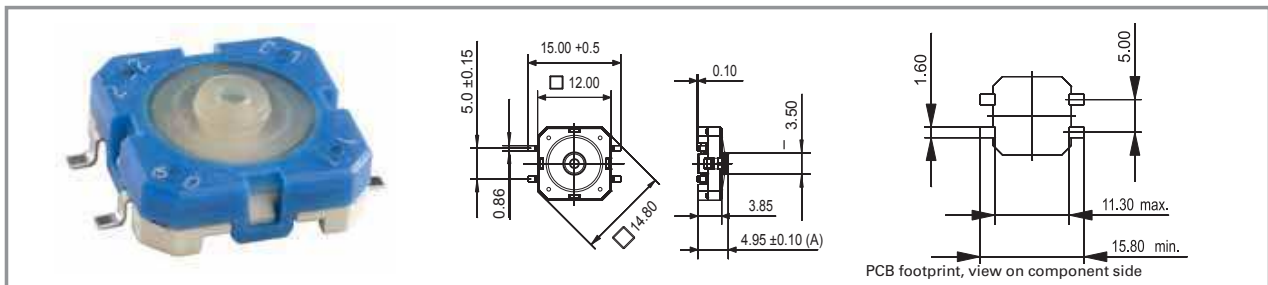

Terminals	Operating force	Switching travel	Solderability / Solder heat resistance	Produkt code	Packing	Order no.
SMT Gullwing (Z)	3.6±0.7 N	0.61±0.1 mm	E DIN IEC 600 68-2-58	C1	tape and reel à 750 pieces	1.14.001.503/0000
SMT Gullwing (Z)	6.8±1.6 N	0.7±0.1 mm	E DIN IEC 600 68-2-58	ZD	tape and reel à 750 pieces	1.14.001.916/0000
SMT Gullwing (Z)	9.7±2.5 N	0.73±0.1 mm	E DIN IEC 600 68-2-58	ZE	tape and reel à 750 pieces	1.14.001.920/0000

Technical data see page 4 - 22

For keycaps refer to chapter „RK 90“, plungers see „RACON special accessories“

RACON 12V - Short-travel keyswitch with vertical adapter



General Data

The RACON 12V version can be used, for example, for PC plug-in boards and for measurement and control engineering applications. The vertical mounting adapter (support element) absorbs the operating force so that the pressure on the soldered terminals is reduced. For this mounting arrangement, the keyswitch is provided with two horizontal terminals on one side.

Technical Data

4

Dimensions

Length	14.5 mm
Width	13.6 mm
Overall height	4.95 mm

Mechanical design

Mounting	soldering
Terminals	THT
Contact system	snap-action contact
Contact arrangement	1 NO
Contact materials	Au
Illumination	no

Mechanical characteristics

Operating force	3.6 \pm 0.7 N
Switching travel	0.61 \pm 0.1 mm

Electrical characteristics

Rated voltage min.	0.02 V
Rated voltage max.	35 V
Rated current min.	0.01 mA
Rated current max.	100 mA
Rated power max. (ohmic load)	1 W

Contact resistance when new max.	100 m Ω
----------------------------------	----------------

Insulation resistance	10 ⁹ Ω
-----------------------	--------------------------

Other specifications

Ambient temp. operating min.	-40 °C
Ambient temp. operating max.	+80 °C
Storage temperature min.	-50 °C
Storage temperature max. (product)	+85 °C
Storage temperature max. (in tube)	+85 °C
Environmental resistance	acc. to IEC 60068-2 -14, -30, -33 and -78
Operating life	1,000,000
Solderability / solder heat resistance	E DIN IEC 600 68-2-20
Flammability of materials	UL 94 HB
Packing	in boxes à 100 pieces
Produkt code	F 1

RACON

PCB footprint RACON 12V

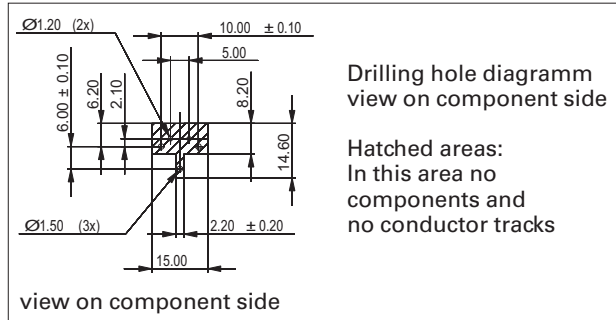

Circuit Diagram RACON 12V

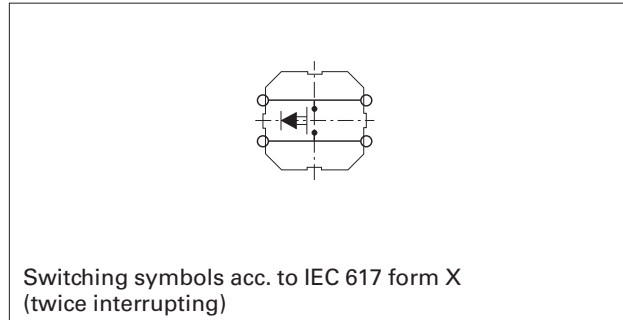

RACON 12V - Short-travel keyswitch with vertical adapter

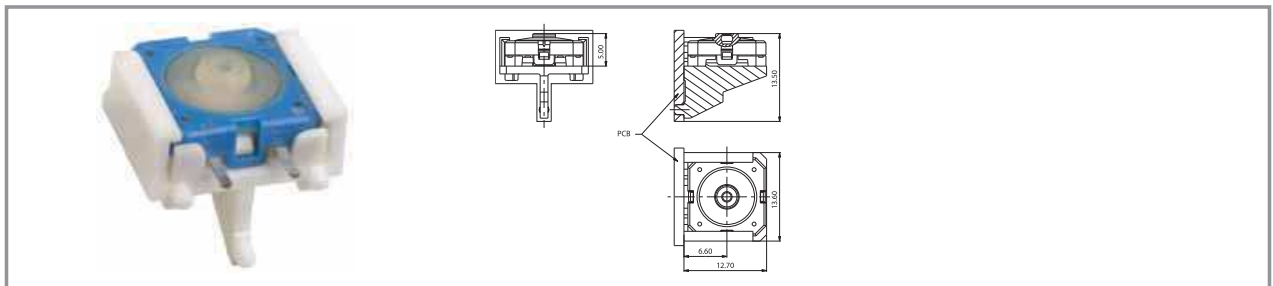

Terminals	Contact arrangement	Produkt code	Packing	Order no.
THT	1 NO	F 1	in boxes à 100 pieces	1.14.001.505/0000

Technical data see page 4 - 26

Plungers for overall height of 6.5 mm may not be used.

RACON 12 i - Short-travel keyswitch

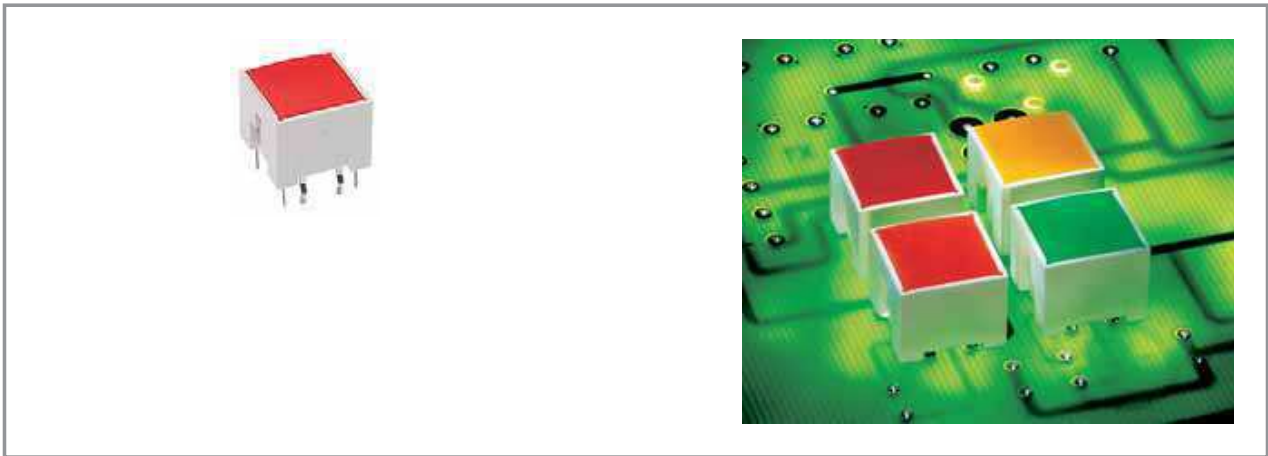

General Data

Application note

Low-profile keyboards with RACON 12 i components should be designed with a grid spacing of 15.24 mm. With this grid, frame webs remain free between the individual keys. The overlay can be glued onto these frame webs; we recommend area embossing over the keys for the overlays. If our RK 90 system design is used, we recommend the 9 x 9 mm keycaps.

Technical Data

4

RACON

General information

Colour of lens	see order block
Recommended key grid	15.24 x 15.24 mm
Key grid min.	12.5 x 12.5 mm

Dimensions

Length	11.35 mm
Width	11.35 mm
Overall height	9.7 mm

Mechanical design

Mounting	soldering
Terminals	THT
Contact system	snap-action contact
Contact arrangement	1 NO
Contact materials	Au
Illumination	fully illuminated

LED colour	see order block
LED type	standard 2 mm

Mechanical characteristics

Operating force	3.3±0.6 N
Switching travel	0.34±0.1 mm

Electrical characteristics

Rated voltage min.	0.02 V
Rated voltage max.	35 V
Rated current min.	0.01 mA
Rated current max.	100 mA
Rated power max. (ohmic load)	1 W
Contact resistance when new max.	100 mΩ

Dielectric strength AC min.	750 V
Insulation resistance	10 ⁹ Ω

Electrical characteristics of LED

LED rated current max. I _F at 25 °C	red/green: 30, yellow: 50 mA
LED current reduction beginning with 50 degree C	red: 0.5 mA/degree C, yellow 0.8 mA/degree C
LED wavelength typ.	red 639, green 510-535, yellow 590
LED forward voltage U _F at 20 mA	red: 1.8 V/20 mA, yellow: 1.9 V/20 mA
LED breakdown voltage U _R at 25 °C	min. 5 V/0.1 mA

Other specifications

Ambient temp. operating min.	-40 °C
Ambient temp. operating max.	+80 °C
Storage temperature min. (product)	see order block
Storage temperature max. (intube)	see order block
Environmental resistance	acc. to IEC 60068-2 -14, -30, -33 and -78
Operating life	1,000,000
Solderability / solder heat resistance	E DIN IEC 600 68-2-20
Flammability of materials	UL 94 HB
Packing	tubes à 45 pieces

RACON 12i typical system assembly

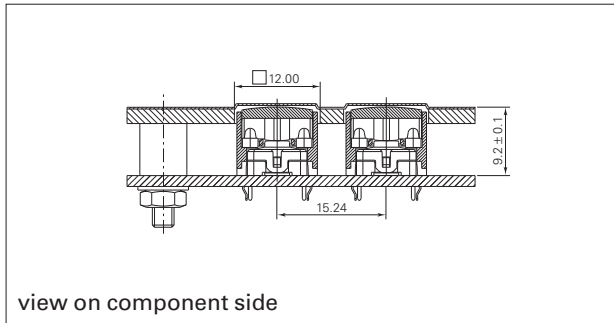

Explanation
Recommended area embossing 0.35 mm at glue spacer
thickness of 0.15 mm

RACON 12i smallest grid

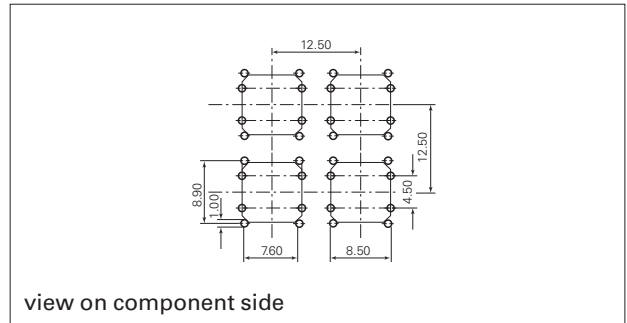

LED hole patterns

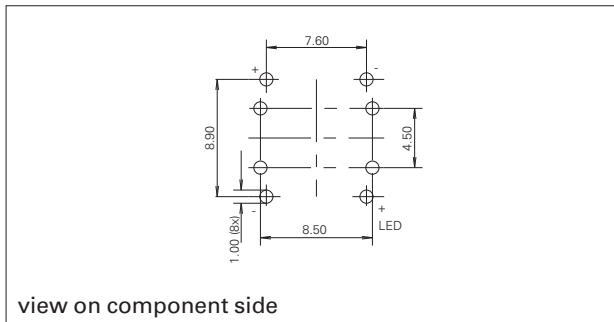

Circuit Diagram RACON 12i

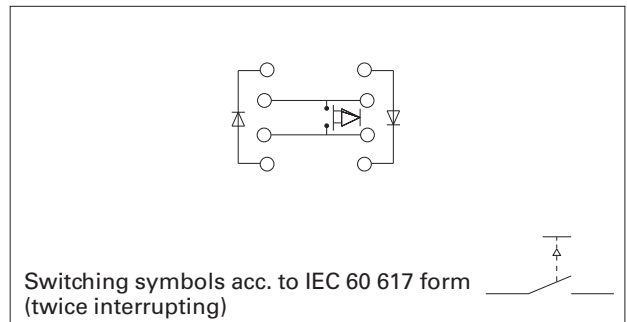

RACON 12 i - Short-travel keyswitch

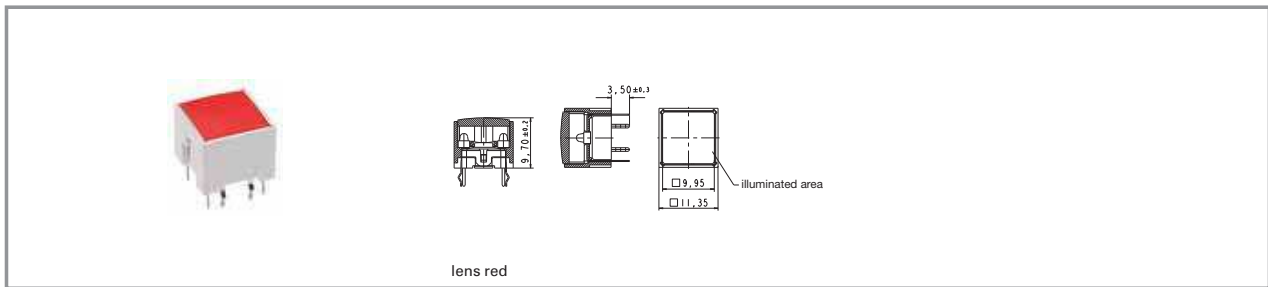

lens red

Terminals	Contact arrangement	Illumination	Colour of lens	LED colour	Order no.
THT	1 NO	fully illuminated 2 LED	red	red	1.14.001.551/0000
THT	1 NO	fully illuminated 2 LED	green	green	1.14.001.552/0000
THT	1 NO	fully illuminated 2 LED	yellow	yellow	1.14.001.553/0000
THT	1 NO	fully illuminated 2 LED	orange	yellow	1.14.001.554/0000

Technical data see page 4 - 28

If keycaps are used we recommend RK 90 keycaps 9 x 9 mm.

RACON - Special accessories



Pict.: 8 mm

General Data

GH = „L“ length of plunger + „A“ height of keyswitch (+ 0.1 mm for SMT versions)
 Front panel cut-out = size of plunger + 1 mm

Plunger round

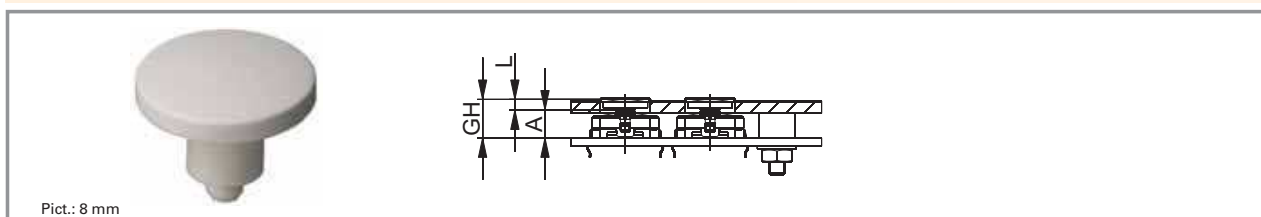

Pict.: 8 mm

4

RACON

Plunger diameter/size	RACON version	Length of plunger L	Order no.
8 mm	RACON 8	1,4 mm	5.46.167.301/0209
8 mm	RACON 8	1.5 mm	5.46.167.102/0209
8 mm	RACON 8	1.6 mm	5.46.167.101/0209
8 mm	RACON 8/12	1,9 mm	5.46.167.090/0209
8 mm	RACON 8/12	2 mm	5.46.167.106/0209
8 mm	RACON 8/12	2.1 mm	5.46.167.107/0209
8 mm	RACON 8/12	4,6 mm	5.46.167.091/0209
8 mm	RACON 8/12	4.7 mm	5.46.167.311/0209
8 mm	RACON 8/12	4.8 mm	5.46.167.094/0209
8 mm	RACON 8/12	7,4 mm	5.46.167.092/0209
8 mm	RACON 8/12	7.5 mm	5.46.167.099/0209
8 mm	RACON 8/12	7.6 mm	5.46.167.096/0209

RACON - Short-travel keyswitches

Plunger diameter/size	RACON version	Length of plunger L	Order no.
11.5 mm	RACON 8	1,4 mm	5.46.167.227/0209
11.5 mm	RACON 8	1.5 mm	5.46.167.061/0209
11.5 mm	RACON 8	1.6 mm	5.46.167.060/0209
11.5 mm	RACON 8/12	2 mm	5.46.167.067/0209
11.5 mm	RACON 8/12	2.1 mm	5.46.167.064/0209
11.5 mm	RACON 8/12	4,6 mm	5.46.167.043/0209
11.5 mm	RACON 8/12	4.7 mm	5.46.167.050/0209
11.5 mm	RACON 8/12	4.8 mm	5.46.167.047/0209
11.5 mm	RACON 8/12	7.5 mm	5.46.167.059/0209
11.5 mm	RACON 8/12	7.6 mm	5.46.167.058/0209
14.5 mm	RACON 8	1,4 mm	5.46.168.227/0209
14.5 mm	RACON 8	1.5 mm	5.46.168.061/0209
14.5 mm	RACON 8	1.6 mm	5.46.168.060/0209
14.5 mm	RACON 8/12	2 mm	5.46.168.067/0209
14.5 mm	RACON 8/12	2.1 mm	5.46.168.064/0209
14.5 mm	RACON 8/12	4,6 mm	5.46.168.043/0209
14.5 mm	RACON 8/12	4.7 mm	5.46.168.050/0209
14.5 mm	RACON 8/12	4.8 mm	5.46.168.047/0209
14.5 mm	RACON 8/12	7,4 mm	5.46.168.044/0209
14.5 mm	RACON 8/12	7.5 mm	5.46.168.059/0209
14.5 mm	RACON 8/12	7.6 mm	5.46.168.058/0209
19 mm	RACON 8	1.5 mm	5.46.169.061/0209
19 mm	RACON 8	1.6 mm	5.46.169.060/0209
19 mm	RACON 8/12	2 mm	5.46.169.067/0209
19 mm	RACON 8/12	2.1 mm	5.46.169.064/0209
19 mm	RACON 8/12	4.7 mm	5.46.169.050/0209
19 mm	RACON 8/12	4.8 mm	5.46.169.047/0209
19 mm	RACON 8/12	7.5 mm	5.46.169.059/0209

4

RACON

Plunger diameter/size	RACON version	Length of plunger L	Order no.
19 mm	RACON 8/12	7.6 mm	5.46.169.058/0209

Front panel cut-out = Plunger diameter + 1 mm.

Square plunger for membrane data entry system

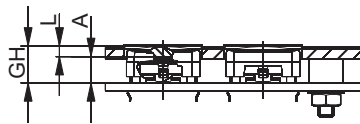

Plunger diameter/size	RACON version	Length of plunger L	Order no.
14 x 14 mm	RACON 12THT	2.1 mm	5.46.001.064/0209
14 x 14 mm	RACON 12THT	4.8 mm	5.46.001.060/0209
14 x 14 mm	RACON 12THT	7.6 mm	5.46.001.063/0209
14 x 14 mm	RACON 12 SMT	2 mm	5.46.001.057/0209
14 x 14 mm	RACON 12 SMT	4.7 mm	5.46.001.058/0209
14 x 14 mm	RACON 12 SMT	7.5 mm	5.46.001.059/0209

Front panel cut-out = 15 x 15 mm.

4

RACON

NEW

RK 90 II, Key cap system for RACON 12 with individual sealing

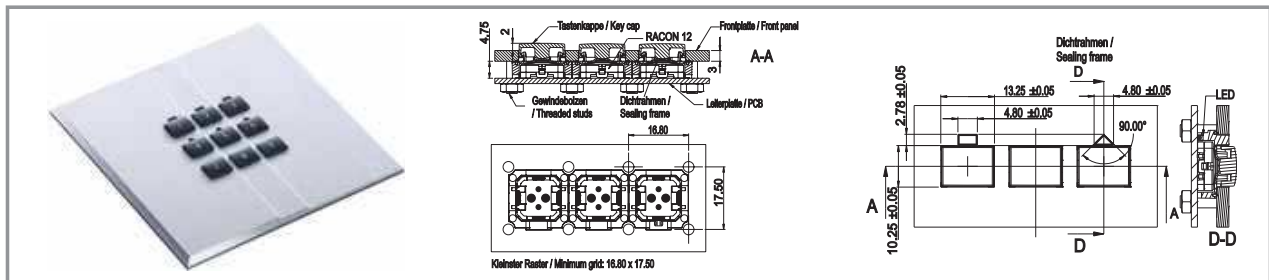

Technical Data

General information

Thickness of front panel	3.00 mm
Light conductor	see order block
Key grid	min. 16.8 x 17.5 mm
Degree of protection	IP 65

The key cap system RK 90 II has been developed especially for the short-travel keyswitch RACON 12. The lenses are snapped onto the sealing frame and then set onto the RACON 12 keyswitches. The PCB presses this units against the front panel, so they are sealed.

Two versions of the sealing frames are provided with light conductors, either in square or triangle form. The lenses can be legended directly with laser. For bright letters (see picture) first white lenses are painted in dark, then the letters are cut out of the dark colour with laser.

4

RACON

RK 90 II - Sealing frame



Thickness of front panel	Light conductor	Order no. without lens	Note
3.00 mm	square	5.05.004.901/0000	Please order lens separately.
3.00 mm	triangular	5.05.004.902/0000	Please order lens separately.
3.00 mm	-	5.05.004.903/0000	Please order lens separately.

Technical data see page 4 - 36

Lenses:

- Lens RK 90 II, white: 5.46.654.192/0200
- Lens RK 90 II, red: 5.46.654.192/0300
- Lens RK 90 II, green: 5.46.654.192/0500
- Lens RK 90 II, blue: 5.46.654.192/0600
- Lens RK 90 II, yellow: 5.46.654.192/0400
- Lens RK 90 II, grey: 5.46.654.192/0700
- Lens RK 90 II, iron grey (varnished): 5.46.654.192/6033
- Lens RK 90 II, grey (varnished): 5.46.654.192/6032

Legended lenses on request.



General Data

RF 15 (15 x 15 mm) and RF 19 (19 x 19 mm) with distinct key click, for use under an overlay or with RK 90 keycaps. Can be fully illuminated.

Content

RF 15 - Short-travel keyswitch	4 - 42
RF 15 - Short-travel keyswitch, non-illuminated	4 - 44
RF 15 - Short-travel keyswitch, fully illuminated with 2 LED	4 - 45
RF 15 - Short-travel keyswitch, 1 LED spot-illumination	4 - 46
RF 15 N - Short-travel keyswitch	4 - 48
RF 15 N - Short-travel keyswitch, non-illuminated	4 - 51
RF 15 R - Short-travel keyswitch	4 - 52
RF 15 R - Low short-travel keyswitch, non-illuminated	4 - 55
RF 15 R - High short-travel keyswitch, non-illuminated	4 - 55
RF 15 R - Low short-travel keyswitch, 1 LED spot-illumination	4 - 56
RF 15 R - High short-travel keyswitch, 1 LED spot-illumination	4 - 57
RF 15 H - Short-travel keyswitch	4 - 58
RF 15 H - Short-travel keyswitch, non-illuminated	4 - 60
RF 15 H - Short-travel keyswitch, fully illuminated	4 - 61
RF 15 - Signal indicator	4 - 62
RF 15 - Signal indicator, fully illuminated, 1 LED	4 - 64
RF 19 - Short-travel keyswitch	4 - 66
RF 19 - Short-travel keyswitch, non-illuminated	4 - 69
RF 19 - Short-travel keyswitch, fully illuminated with 2 LED	4 - 70
RF 19 - Short-travel keyswitch, 1 LED spot-illumination	4 - 71
RF 19 H - Short-travel keyswitch	4 - 72
RF 19 H - Keyswitch, non-illuminated	4 - 74
RF 19 H - Short-travel keyswitch, fully illuminated	4 - 75
RF 19 - Signal indicator	4 - 76
RF 19 - Signal indicator, 1/2 x 1-module	4 - 78
RF 19 - Signal indicator, 1/2 x 2-module	4 - 78
RF 19 - Signal indicator, 1 x 1-module	4 - 79
RF 19 - Signal indicator, 1 x 2-module	4 - 79
PCB Keyswitches	4 - 39

RF 15/19 - Special accessories	4 - 80
RF 15 N - Extension plunger, round head	4 - 80
RF 15 N - Extension plunger, round head, with recess for LED	4 - 81
RF 15 - Keycap, snap-on, for overall height 12.5 mm	4 - 81
Spacers, round	4 - 82
Spacers, triangular	4 - 83
RF 15 N - LED spacer	4 - 84

4

RF

Specifications LED

3 mm LED

(valid for 25 °C)	Red LED	Green LED	Yellow LED
Max. forward current I _F :	30 mA	30 mA	20 mA
Current reduction from: T ₀ = 50 °C:	approx 0.5 mA/°C	approx 0.5 mA/°C	approx 0.2 mA/°C
Wavelength typ:	635 nm	565 nm	586 nm
Forward voltage U _F /I _F typ:	2 V/10 mA	2 V/10 mA	2 V/10 mA
Reverse voltage U _R /I _F typ:	5 V/100 µA min.	5 V/100 µA min.	5 V/100 µA min.
Ambient temperature, operating:	- 20 °C ... + 80 °C	- 20 °C ... + 80 °C	- 20 °C ... + 80 °C
	Blue LED	White LED	Green LED superbright
Max. forward current I _F :	20 mA	25 mA	30 mA
Current reduction from: T ₀ = 50 °C:	approx 0.6 mA/°C	-	-
Wavelength typ:	470 nm	-	510-545 nm
Forward voltage U _F /I _F typ:	2.7 V/10 mA	3.6 V/20 mA	3.5 V/20 mA
Reverse voltage U _R /I _F typ:	5 V/100 µA min.	-	-
Ambient temperature, operating:	- 20 °C ... + 80 °C	- 20 °C ... + 80 °C	-30 °C ... + 100 °C

2 mm LED (full illumination of RF 15/19)

(valid for 25 °C)	Red LED	Green LED	Yellow LED
Max. forward current I _F :	30 mA	30 mA	50 mA
Current reduction from: T ₀ = 50 °C:	0.5 mA/°C	0.5 mA/°C	0.8 mA/°C
Light current f _v /I _F typ:	-	-	250 mlm/20 mA
Wavelength typ:	637 nm	569 nm	590 nm
Forward voltage U _F /I _F typ:	1.8 V/20 mA	2.1 V/10 mA	1.9 V/20 mA
Reverse voltage U _R /I _F typ:	5 V/100 µA min.	5 V/100 µA min.	5 V/100 µA min.
Ambient temperature, operating:	- 55 °C ... + 100 °C	- 40 °C ... + 100 °C	-40 °C ... + 100 °C
	Blue LED	Multi-colour LED	
Max. forward current I _F :	30 mA	30 mA	
Current reduction from: T ₀ = 50 °C:	-	approx 0.6 mA/°C	
Light current f _v /I _F typ:	-	-	
Wavelength typ:	464-485 nm	635/565 nm	
Forward voltage U _F /I _F typ:	3.6 V/20 mA	2 V/10 mA	
Reverse voltage U _R /I _F typ:	-	-	
Ambient temperature, operating:	- 20 °C ... + 80 °C	- 20 °C ... + 80 °C	

4

Calculating the series resistor:

$$R_V = \frac{U_B - U_F}{I_F}$$

Rated power of series:

$$P_V = I_F^2 \times R_V$$

Example for 5 Volt:

$$R_V = \frac{5V - 2,0V}{0,02 A} = 150 \Omega (= \text{standard value})$$

RF

RF 15 - Short-travel keyswitch

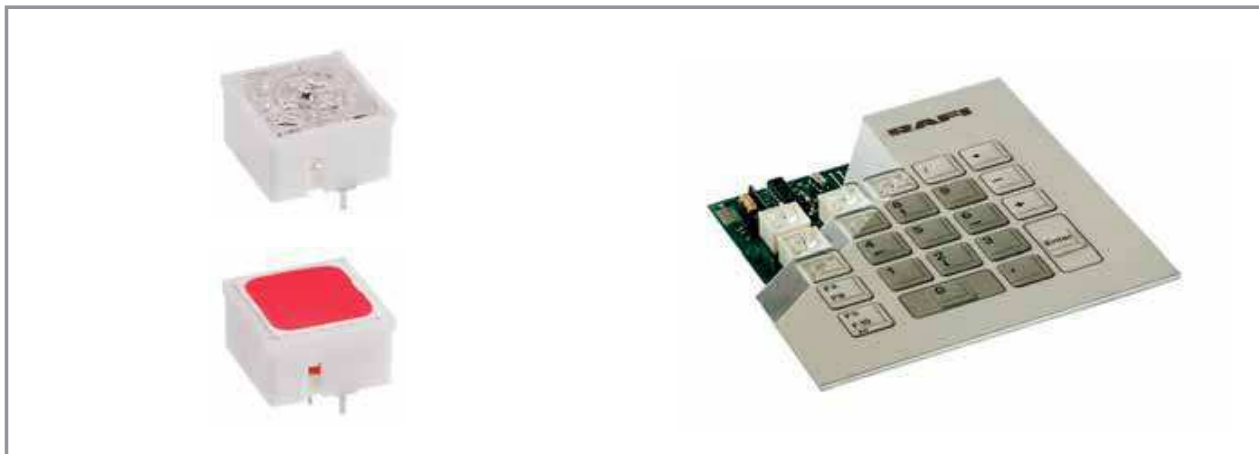

General Data

Low-profile keyboards with RF 15 components should be designed with a 19.05 mm grid. With this grid, frame webs remain free between the individual keys. The overlay can be glued onto these frame webs; we recommend area embossing over the keys for the overlays.

Technical Data

4

General information

Colour of lens see order block
 Recommended key grid 19.05 mm

Dimensions

Length 15 mm
 Width 15 mm
 Overall height 9.7 mm

Mechanical design

Mounting soldering in PCB
 Terminals THT
 Contact system snap-action contact
 Contact arrangement 1 NO
 Contact materials see order block
 Illumination see order block
 LED colour see order block
 LED type see order block

Mechanical characteristics

Operating force max. 2.9 ± 0.6 N
 Switching travel $0.5^{+0.2}$ mm
 Robustness min. with through-plated PCB 100 N

Electrical characteristics

Rated voltage min. Au: 0.02 V, Ag: 3 V
 Rated voltage max. Au: 35 V, Ag: 50 V
 Rated current min. Au: 0.01 mA, Ag: 0.1 mA
 Rated current max. Au: 100 mA, Ag: 250 mA
 Rated power max. (ohmic load) Au: 2 W, Ag: 12.5 W
 Contact resistance when new max. 100 mΩ
 Insulation resistance $10^9 \Omega$

Other specifications

Ambient temp. operating min. -25 °C
 Ambient temp. operating max. +70 °C
 Environmental resistance acc. to IEC 60068-2 -14, -30, -33 and -78
 Operating life min. (operations) 1,000,000
 Solderability / solder heat resistance according to E DIN IEC 600 28-2-20
 Wave soldering 260 °C max.
 Manual soldering 350 °C / 5 sec. max.

RF

Force/Travel Diagram – Keyswitch RF 15

Operation characteristic limits RF

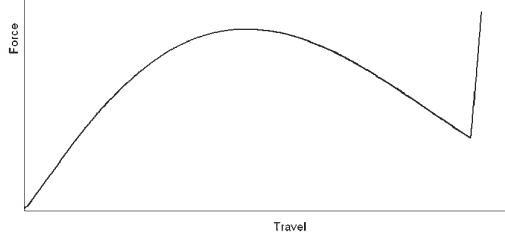

Circuit Diagram – Keyswitch RF 15

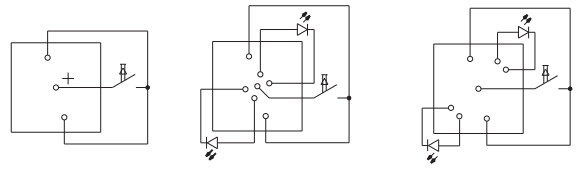

Keyswitch, non-illuminated

Keyswitch, fully illuminated

Keyswitch, spot-illuminated

Dimensional Drawing RF 15

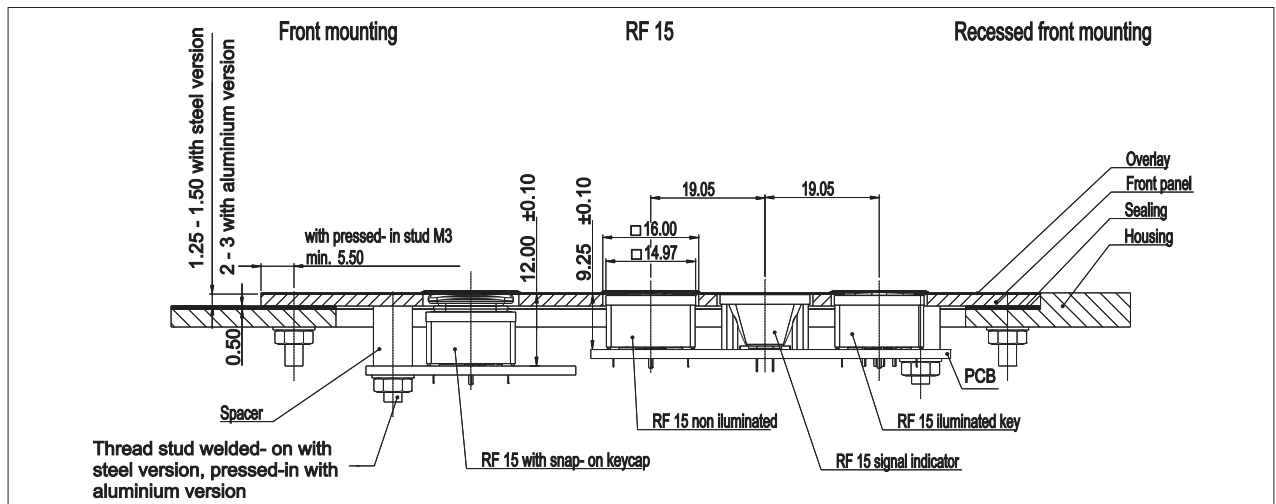

4

Hole Pattern RF 15

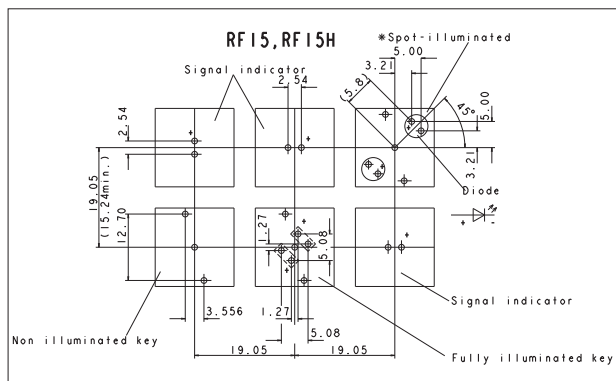

View on component side, all hole diameters 1,1 +/- 0,1 mm

PCB Keyswitches

Hole Pattern – Front Panel

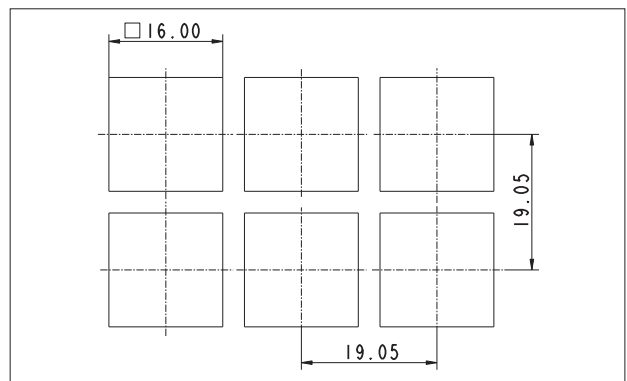

RF

RF 15 - Short-travel keyswitch, non-illuminated

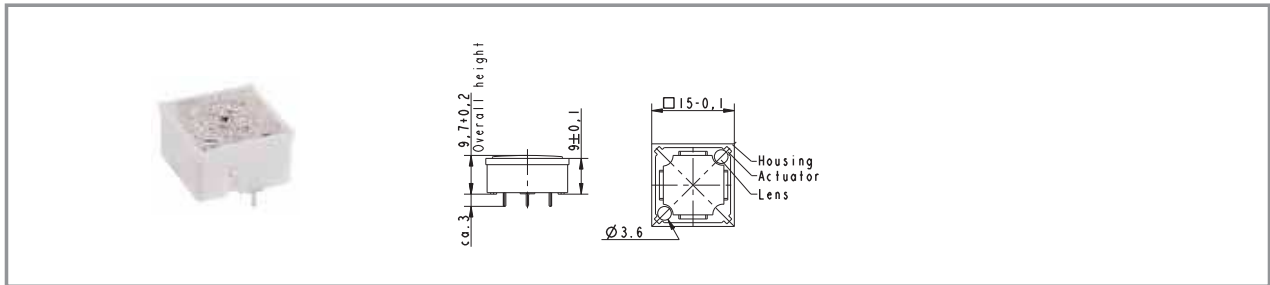

Contact materials	Illumination	Colour of lens	LED colour	LED type	Order no.
Au	not illuminated	transparent	-	-	3.14.100.001/0000
Ag	not illuminated	transparent	-	-	3.14.100.006/0000

Technical data see page 4 - 42

For keycaps, refer to chapter accessories and system RK 90.

If exchangeable legends are required, or if an overall height of 12.5 mm is required, a keycap can be mounted on the non-illuminated keys. The keycap legend is visible through a window in the overlay. You can change the legend by replacing the keycap.

RF 15 - Short-travel keyswitch, fully illuminated with 2 LED

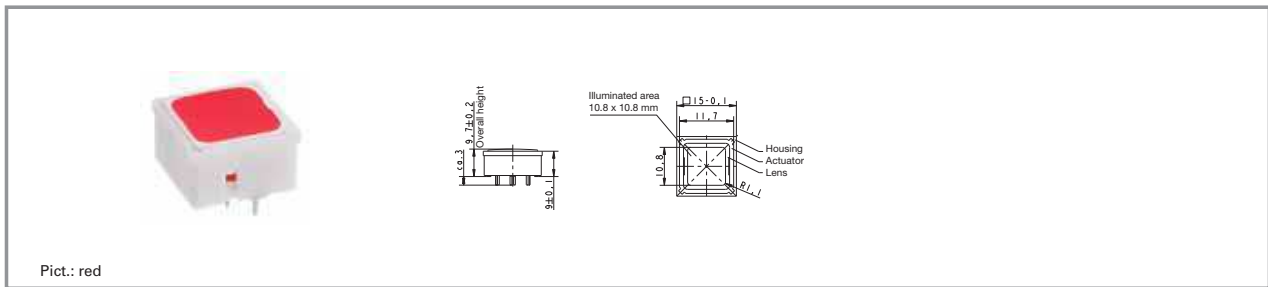

Contact materials	Illumination	Colour of lens	LED colour	LED type	Order no.
Au	fully illuminated 2 LED	red	red	2 mm	3.14.200.011/0000
Au	fully illuminated 2 LED	green	green	2 mm	3.14.200.012/0000
Au	fully illuminated 2 LED	yellow	yellow	2 mm	3.14.200.013/0000
Au	fully illuminated 2 LED	orange	yellow	2 mm	3.14.200.014/0000
Au	fully illuminated 2 LED	blue	blue	2 mm	3.14.200.015/0000
Ag	fully illuminated 2 LED	red	red	2 mm	3.14.200.021/0000
Ag	fully illuminated 2 LED	green	green	2 mm	3.14.200.022/0000
Ag	fully illuminated 2 LED	yellow	yellow	2 mm	3.14.200.023/0000
Ag	fully illuminated 2 LED	orange	yellow	2 mm	3.14.200.024/0000
Ag	fully illuminated 2 LED	blue	blue	2 mm	3.14.200.025/0000

Technical data see page 4 - 42

For keycaps, refer to RK 90 system design.

Technical data of LED see separate page at the beginning of this chapter.

RF 15 - Short-travel keyswitch, 1 LED spot-illumination

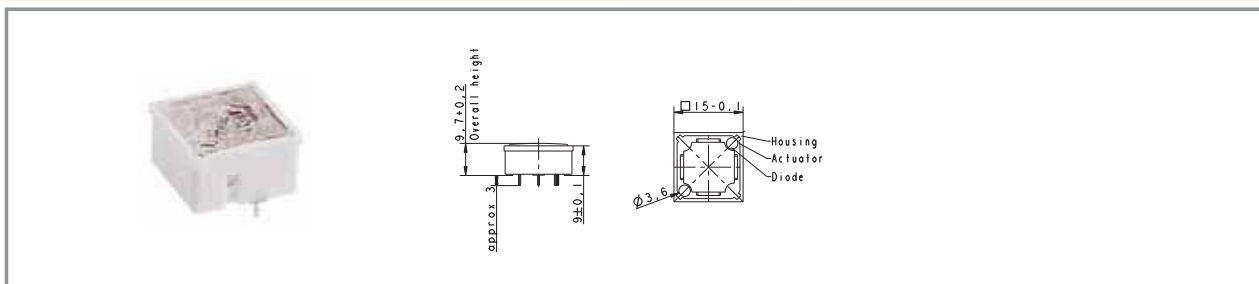

Contact materials	Illumination	Colour of lens	LED colour	LED type	Order no.
Au	spot illumination 1 LED	opaque white	blue	3 mm	3.14.100.030/0000
Au	spot illumination 1 LED	opaque white	red	3 mm	3.14.100.031/0000
Au	spot illumination 1 LED	opaque white	green	3 mm	3.14.100.032/0000
Au	spot illumination 1 LED	opaque white	yellow	3 mm	3.14.100.033/0000
Ag	spot illumination 1 LED	opaque white	blue	3 mm	3.14.100.040/0000
Ag	spot illumination 1 LED	opaque white	red	3 mm	3.14.100.041/0000
Ag	spot illumination 1 LED	opaque white	green	3 mm	3.14.100.042/0000
Ag	spot illumination 1 LED	opaque white	yellow	3 mm	3.14.100.043/0000

Technical data see page 4 - 42

Double-spot LED illumination available on request

Technical data of LED see separate page at the beginning of this chapter.

4

RF

RF 15 N - Short-travel keyswitch



General Data

The RF 15N keyswitch provides a minimum overall height of 6.2 mm. The overall height can be varied by extension plungers which are inserted into the cross-like notches on the actuator tops. LEDs can only be arranged separately next to the keyswitches up to an overall height of 10 mm (i.e. without plunger or with small plunger). Keyswitches with overall heights of 12 mm or more can be provided with a maximum of 2 LEDs which are inserted into the recesses of the keyswitch housing. LEDs of keyswitches with overall heights of 12.5 mm or more should be placed onto LED spacers in order to obtain satisfactory illumination.

Technical Data

4

General information

Colour of lens see order block
 Recommended key grid 19.05 mm

Dimensions

Length 15 mm
 Width 15 mm
 Overall height 6.2 mm

Mechanical design

Mounting soldering in PCB
 Terminals THT
 Contact system snap-action contact
 Contact arrangement 1 NO
 Contact materials see order block
 Illumination external 3 mm LED possible if height more than 12 mm

Mechanical characteristics

Operating force max. $2.9^{+0.6}$ N
 Switching travel $0.5^{+0.2}$ mm
 Robustness min. 100 with through-plated PCB N

Electrical characteristics

Rated voltage min. Au: 0.02 V, Ag: 3 V
 Rated voltage max. Au: 35 V, Ag: 50 V
 Rated current min. Au: 0.01 mA, Ag: 0.1 mA
 Rated current max. Au: 100 mA, Ag: 250 mA
 Rated power max. (ohmic load) Au: 2 W, Ag: 12.5 W
 Contact resistance when new max. 100 mΩ
 Insulation resistance $10^9 \Omega$

Other specifications

Ambient temp. operating min. -25 °C
 Ambient temp. operating max. +70 °C
 Storage temperature max. (in tube) +50 °C
 Environmental resistance acc. to IEC 60068-2 -14, -30, -33 and -78 1,000,000
 Operating life min. (operations) 1,000,000
 Solderability / solder heat resistance according to E DIN IEC 600 28-2-20
 Wave soldering 260 °C max.
 Manual soldering 350 °C / 5 sec. max.

RF

Force/Travel Diagram – Keyswitch RF 15 N

Operation characteristic limits RF

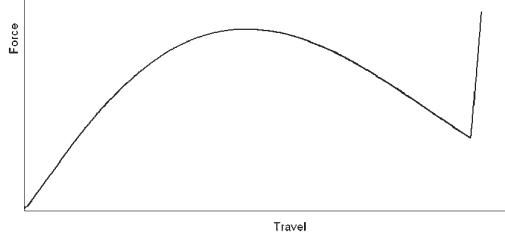

Circuit Diagram – Keyswitch RF 15 N

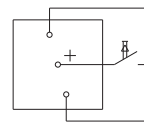

Keyswitch, non illuminated

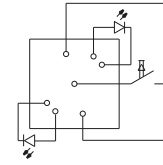

Keyswitch, spot-illuminated

Dimensional Drawings RF 15 N

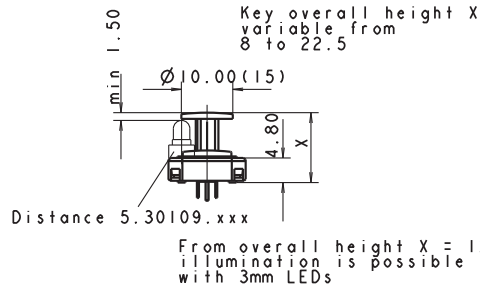
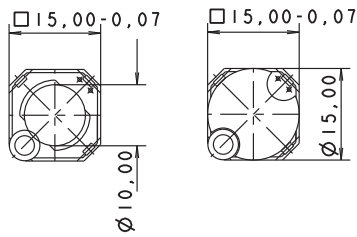

4

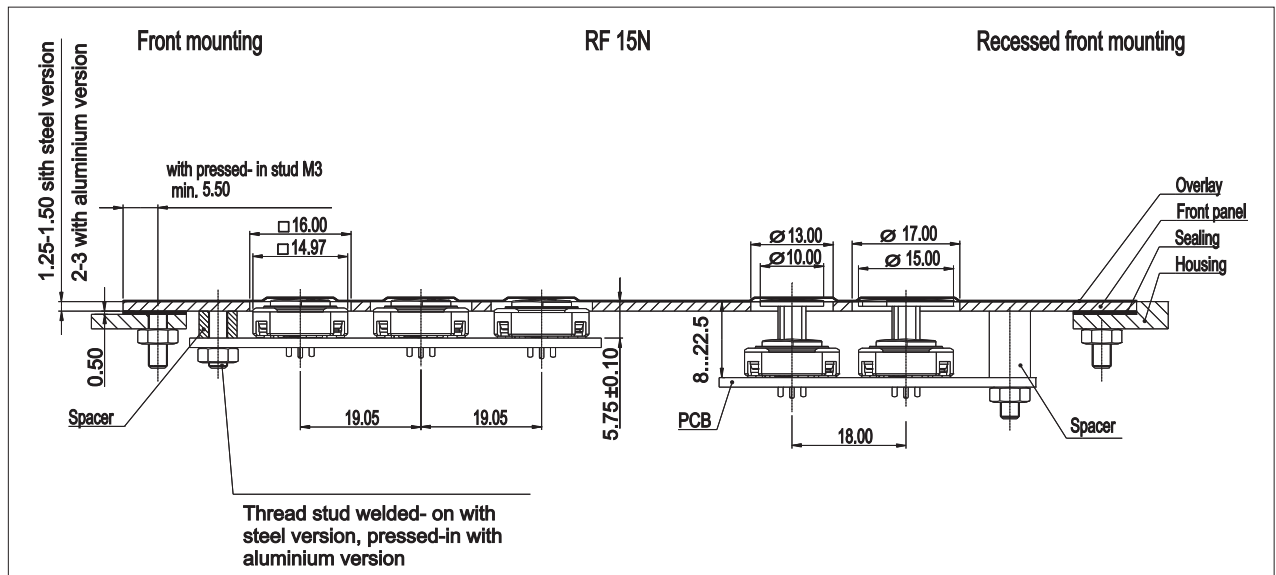

RF

Hole Patterns – Front Panel RF 15 N

RF 15 N without plunger

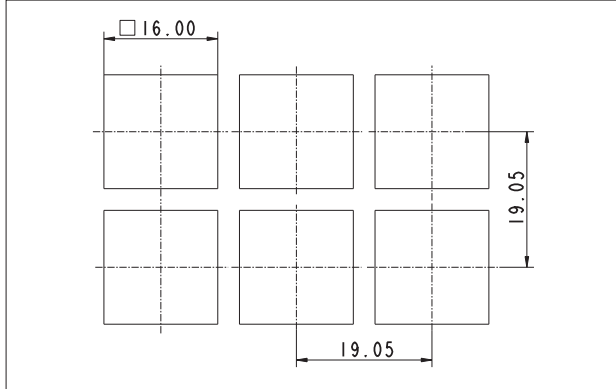

RF 15 N with plunger \varnothing 10 mm, non-illuminated

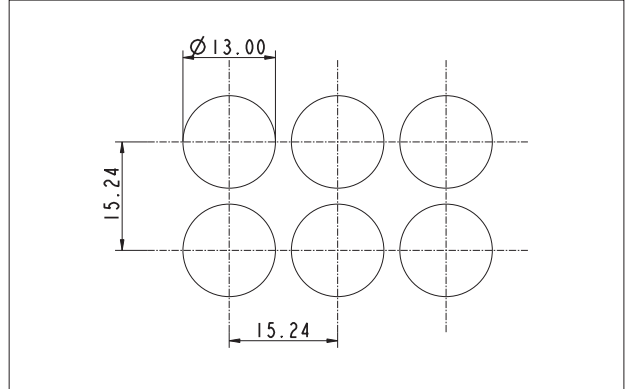

RF 15 N with plunger \varnothing 10 mm, illuminated

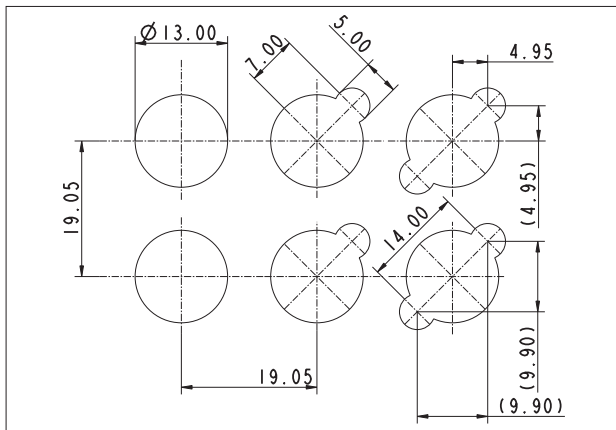

RF 15 N with plunger \varnothing 15 mm, illuminated

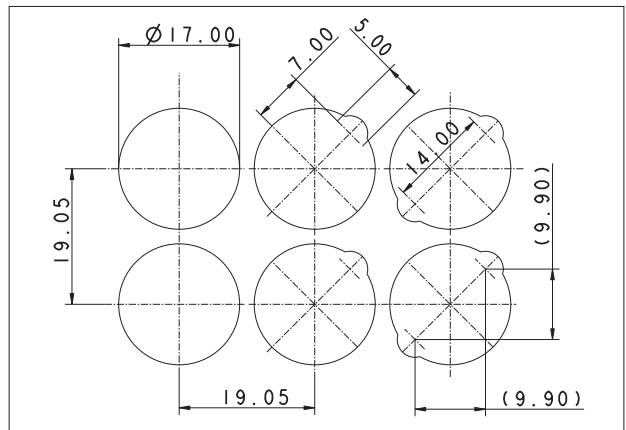

4

Hole Pattern RF 15 N

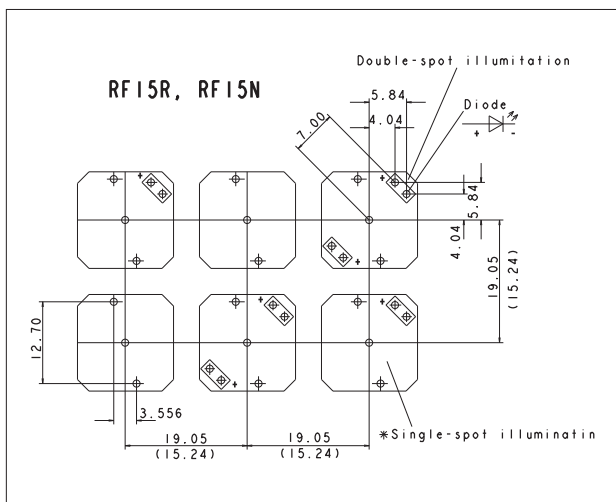

View on component side
All hole diameters 1.1 ± 0.1 mm
PCB layout keyswitch 1/400" grid

RF

Typical accessories RF 15 N - Short-travel keyswitch

Description	Photo	Order no.	Additional accessories see page
RF 15 N - LED spacer \varnothing 5 mm, spacing length 2.2 mm, light grey, for use with overall height of 12.5 mm		5.30.109.010/0756	4 - 84
RF 15 N - Extension plunger, \varnothing 10 mm, overall height 22.5 mm		5.46.011.028/0710	4 - 80
RF 15 N - Extension plunger, \varnothing 15 mm, overall height 22.5 mm		5.46.017.028/0710	4 - 81

RF 15 N - Short-travel keyswitch, non-illuminated

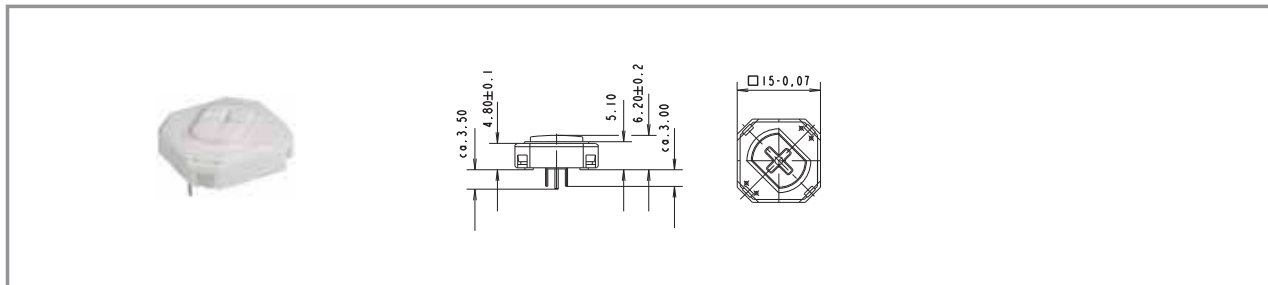

Contact materials	Illumination	Recommended key grid	Overall height	Order no.
Au	external 3 mm LED possible if height more than 12 mm	19.05 mm	6.2 mm	3.14.100.601/0000
Ag	external 3 mm LED possible if height more than 12 mm	19.05 mm	6.2 mm	3.14.100.606/0000

Technical data see page 4 - 48

For keycaps, refer to RK 90 system design.
Double-spot LED illumination available on request.

RF 15 R - Short-travel keyswitch



General Data

The round actuator of the RF 15 R keyswitch requires round front panel cut-outs. These make it possible to use a narrow keyboard grid of only 15.24 mm with sufficiently large frame webs between the individual keys. We recommend area embossing over the actuators for the overlay.

Technical Data

4

General information

Recommended key grid 15.24 mm

Dimensions

Length 15 mm
 Width 15 mm
 Overall height see order block

Mechanical design

Mounting soldering in PCB
 Terminals THT
 Contact system snap-action contact
 Contact arrangement 1 NO
 Contact materials see order block
 Illumination see order block
 LED colour see order block
 LED type see order block

RF

Mechanical characteristics

Operating force max. $2.9^{+0.6}$ N
 Switching travel $0.5^{+0.2}$ mm
 Robustness min. with through-plated PCB 100 N

Electrical characteristics

Rated voltage min. Au: 0.02 V, Ag: 3 V
 Rated voltage max. Au: 35 V, Ag: 50 V
 Rated current min. Au: 0.01 mA, Ag: 0.1 mA
 Rated current max. Au: 100 mA, Ag: 250 mA
 Rated power max. (ohmic load) Au: 2 W, Ag: 12.5 W
 Contact resistance when new max. 100 mΩ
 Insulation resistance $10^9 \Omega$

Other specifications

Ambient temp. operating min. -25 °C
 Ambient temp. operating max. +70 °C
 Environmental resistance acc. to IEC 60068-2 -14, -30, -33 and -78 1,000,000
 Operating life min. (operations) 1,000,000
 Solderability / solder heat resistance according to E DIN IEC 600 28-2-20
 Wave soldering 260 °C max.
 Manual soldering 350 °C / 5 sec. max.

Force/Travel Diagram – Keyswitch RF 15 R

Operation characteristic limits RF

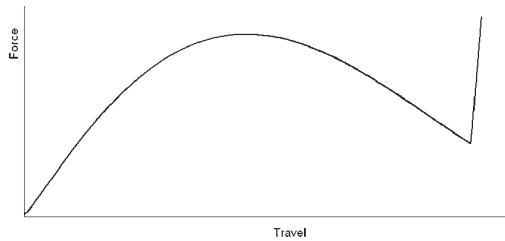

Circuit Diagram – Keyswitch RF 15 R

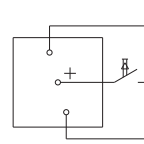

Keyswitch, non-illuminated

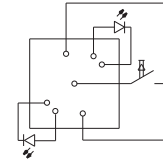

Keyswitch, spot-illuminated

Dimensional Drawing RF 15 R

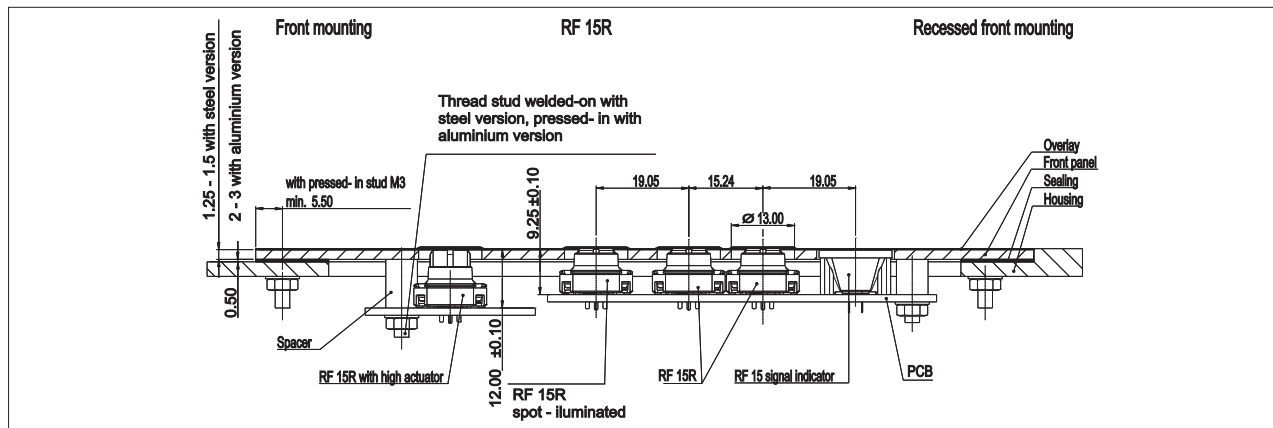

4

Hole Pattern RF 15 R

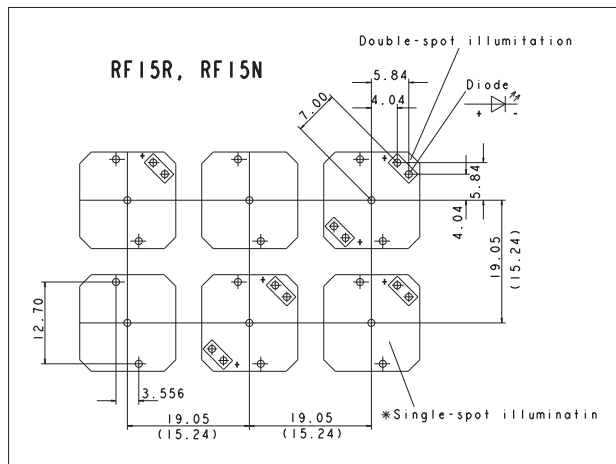

View on component side
All hole diameters 1.1 ± 0.1 mm
PCB layout keyswitch 1/400" grid

RF

RF 15 R - Low short-travel keyswitch, non-illuminated

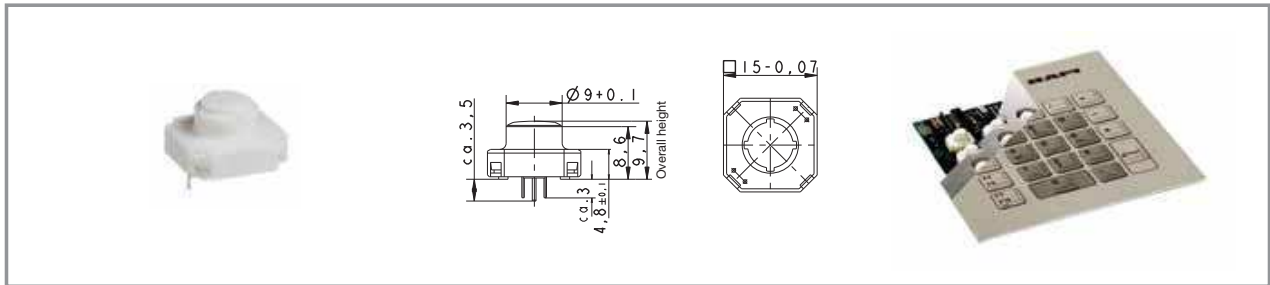

Contact materials	Overall height	Illumination	LED type	LED colour	Order no.
Au	9.7 mm	not illuminated	-	-	3.14.100.501/0000
Ag	9.7 mm	not illuminated	-	-	3.14.100.506/0000

Technical data see page 4 - 52

RF 15 R - High short-travel keyswitch, non-illuminated

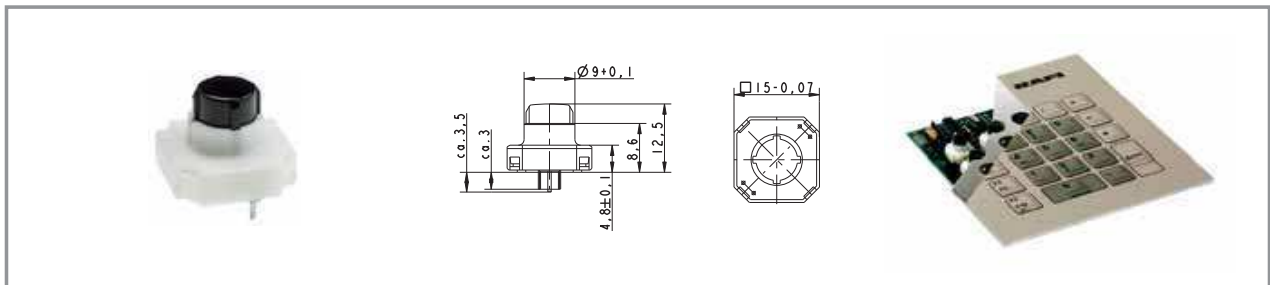

Contact materials	Overall height	Illumination	LED type	LED colour	Order no.
Au	12.5 mm	not illuminated	-	-	3.14.100.801/0000
Ag	12.5 mm	not illuminated	-	-	3.14.100.806/0000

Technical data see page 4 - 52

RF 15 R - Low short-travel keyswitch, 1 LED spot-illumination

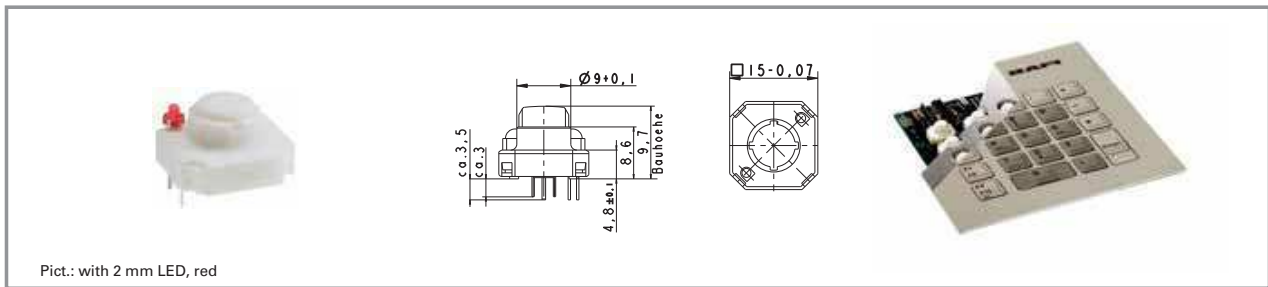

Pict.: with 2 mm LED, red

Contact materials	Overall height	Illumination	LED type	LED colour	Order no.
Au	9.7 mm	spot illumination 1 LED	2 mm	red	3.14.100.531/0000
Au	9.7 mm	spot illumination 1 LED	2 mm	green	3.14.100.532/0000
Au	9.7 mm	spot illumination 1 LED	2 mm	yellow	3.14.100.533/0000
Ag	9.7 mm	spot illumination 1 LED	2 mm	red	3.14.100.541/0000
Ag	9.7 mm	spot illumination 1 LED	2 mm	green	3.14.100.542/0000
Ag	9.7 mm	spot illumination 1 LED	2 mm	yellow	3.14.100.543/0000

Technical data see page 4 - 52

Versions with 2 LEDs available on request.

Technical data of LED see separate page at the beginning of this chapter.

4

RF

RF 15 R - High short-travel keyswitch, 1 LED spot-illumination

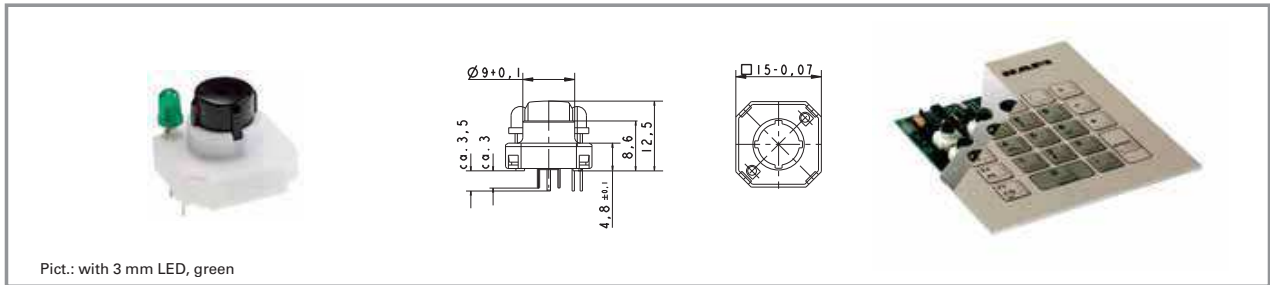

Pict.: with 3 mm LED, green

Contact materials	Overall height	Illumination	LED type	LED colour	Order no.
Au	12.5 mm	spot illumination 1 LED	3 mm	blue	3.14.100.830/0000
Au	12.5 mm	spot illumination 1 LED	3 mm	red	3.14.100.831/0000
Au	12.5 mm	spot illumination 1 LED	3 mm	green	3.14.100.832/0000
Au	12.5 mm	spot illumination 1 LED	3 mm	yellow	3.14.100.833/0000

Technical data see page 4 - 52

Versions with 2 LEDs available on request.

Technical data of LED see separate page at the beginning of the chapter.

RF 15 H - Short-travel keyswitch

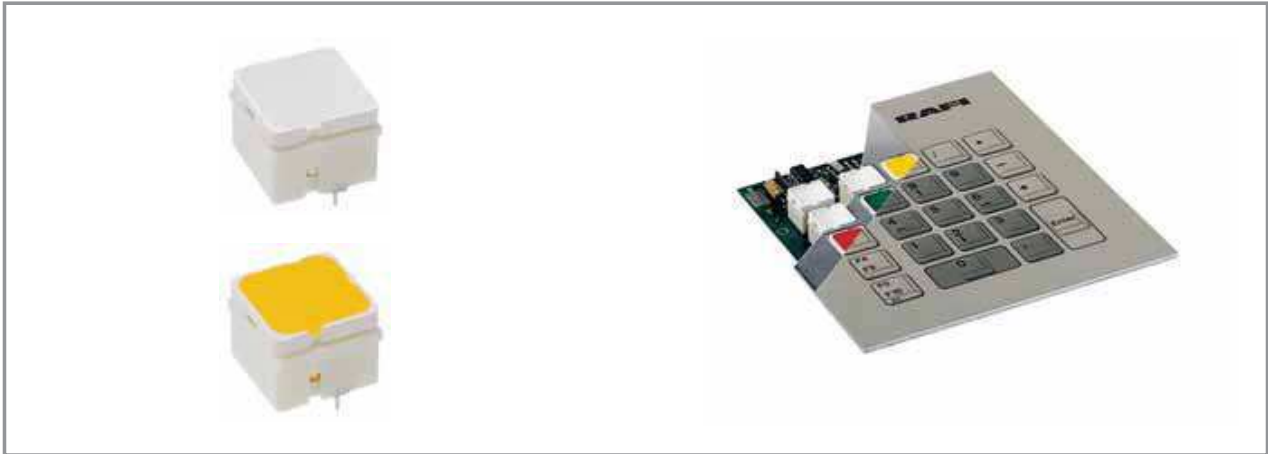

General Data

Application notes:

The RF 15 H key has an overall height of 12.5 mm and can be fully illuminated. When designing membrane keyboards, we recommend using a key grid of at least 20 mm and a 0.13 mm overlay with area embossing over the keys. You can use the O-ring (accessory) to block the key and use it as an indicator field or blank spaceholder.

Technical Data

4

General information

Colour of lens see order block
Recommended key grid 20 mm

Dimensions

Length 15 mm
Width 15 mm
Overall height 12.5 mm

Mechanical design

Mounting soldering in PCB
Terminals THT
Contact system snap-action contact
Contact arrangement 1 NO
Contact materials see order block
Illumination see order block
LED colour see order block
LED type see order block

Mechanical characteristics

Operating force max. 2.9±0.6 N
Switching travel 0.5±0.2 mm
Robustness min. with through-plated PCB 100 N

Electrical characteristics

Rated voltage min. Au: 0.02 V, Ag: 3 V
Rated voltage max. Au: 35 V, Ag: 50 V
Rated current min. Au: 0.01 mA, Ag: 0.1 mA
Rated current max. Au: 100 mA, Ag: 250 mA
Rated power max. (ohmic load) Au: 2 W, Ag: 12.5 W
Contact resistance when new max. 100 mΩ
Insulation resistance 10⁹ Ω

Other specifications

Ambient temp. operating min. -25 °C
Ambient temp. operating max. +70 °C
Environmental resistance acc. to IEC 60068-2 -14, -30, -33 and -78 1,000,000
Operating life min. (operations)
Solderability / solder heat resistance according to E DIN IEC 600 28-2-20
Wave soldering 260 °C max.
Manual soldering 350 °C / 5 sec. max.

RF

Force/Travel Diagram – Keyswitch RF 15 H

Operation characteristic limits RF

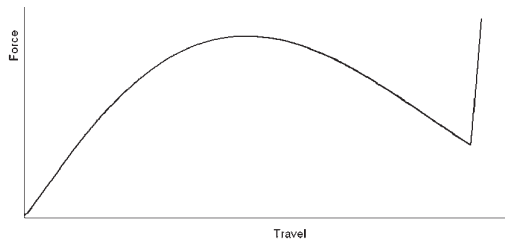

Circuit Diagram – Keyswitch RF 15 H

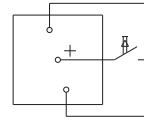

Keyswitch, non-illuminated

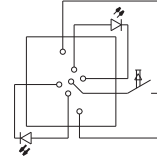

Keyswitch, fully illuminated

Dimensional Drawing

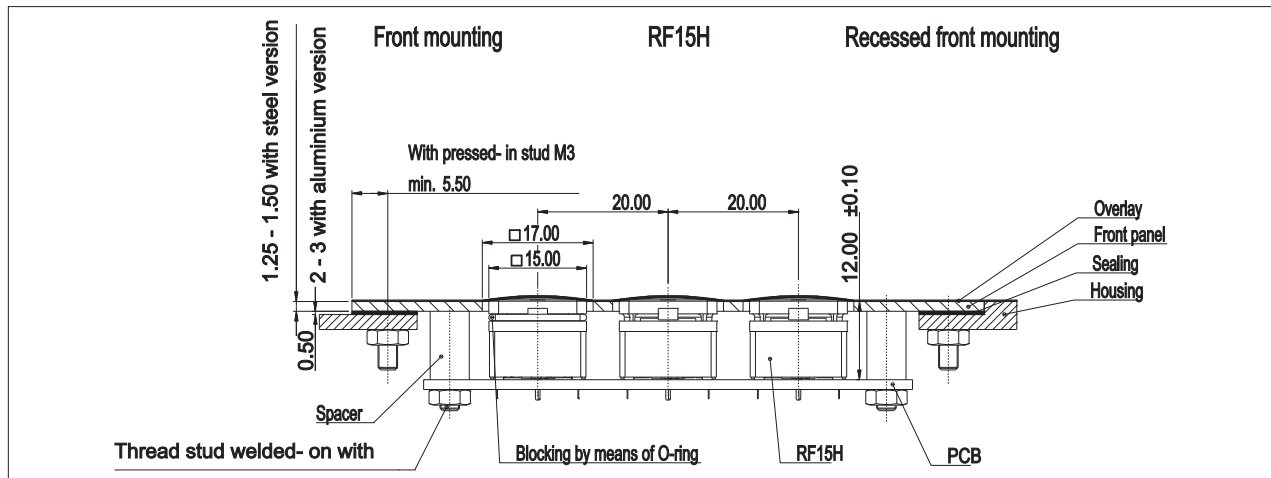

4

Hole Pattern

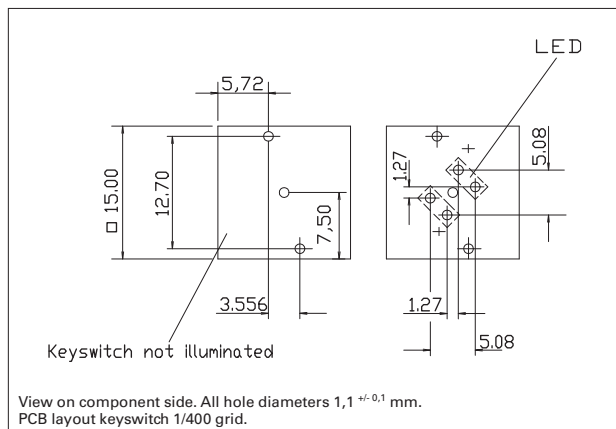

Hole Pattern – Front Panel

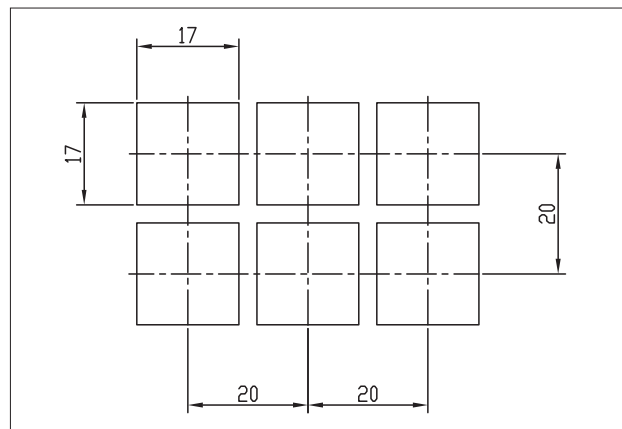

RF

Typical accessories RF 15 H - Short-travel keyswitch

Description	Photo	Order no.	Additional accessories see page
O-ring, black, for blocking the operating stroke		5.30.120.009/0100	5 - 25

RF 15 H - Short-travel keyswitch, non-illuminated

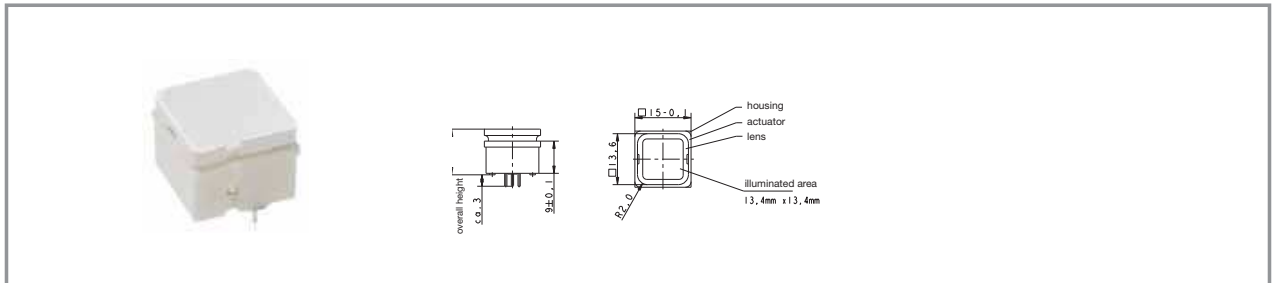

Contact materials	Illumination	Colour of lens	LED colour	LED type	Order no.
Au	not illuminated	white	-	-	3.14.100.702/0000
Ag	not illuminated	white	-	-	3.14.100.707/0000

Technical data see page 4 - 58

RF 15 H - Short-travel keyswitch, fully illuminated

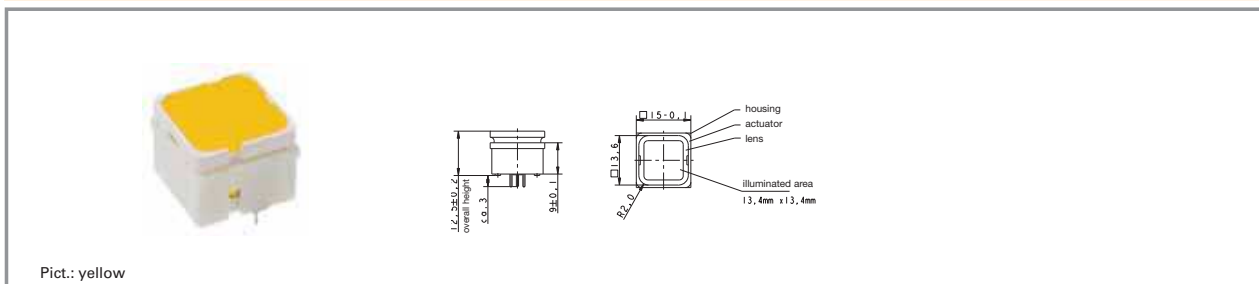

Contact materials	Illumination	Colour of lens	LED colour	LED type	Order no.
Au	fully illuminated 2 LED	red	red	2 mm	3.14.200.731/0000
Au	fully illuminated 2 LED	green	green	2 mm	3.14.200.732/0000
Au	fully illuminated 1 LED	green	green super bright	3 mm	3.14.200.736/0000
Au	fully illuminated 2 LED	yellow	yellow	2 mm	3.14.200.733/0000
Au	fully illuminated 1 LED	white	white	3 mm	3.14.200.735/0000
Au	fully illuminated 2 LED	orange	yellow	2 mm	3.14.200.738/0000
Au	fully illuminated 1 LED	blue	blue	3 mm	3.14.200.739/0000
Au/Ag	fully illuminated 2 LED	yellow	multi colour	3 mm	3.14.101.903/0000
Ag	fully illuminated 2 LED	red	red	2 mm	3.14.200.741/0000
Ag	fully illuminated 2 LED	green	green	2 mm	3.14.200.742/0000
Ag	fully illuminated 1 LED	green	green super bright	3 mm	3.14.200.746/0000
Ag	fully illuminated 2 LED	yellow	yellow	2 mm	3.14.200.743/0000
Ag	fully illuminated 1 LED	white	white	3 mm	3.14.200.745/0000
Ag	fully illuminated 2 LED	orange	yellow	2 mm	3.14.200.748/0000
Ag	fully illuminated 1 LED	blue	blue	3 mm	3.14.200.749/0000
Ag	fully illuminated 2 LED	white	multi colour	3 mm	3.14.100.744/0000

Technical data see page 4 - 58

When using the keyswitches with multicolour LEDs the illumination colour can be varied from red to green by change of polarity. Due to the frequency of the polarity-changes the colours red, green, yellow as well as all secondary colours from these are possible.

Technical data of LED see separate page at the beginning of this chapter.

4

RF

RF 15 - Signal indicator



Technical Data

General information

Colour of lens see order block
Recommended key grid 19.05 mm

Dimensions

Length 15 mm
Width 15 mm
Overall height 9.7 mm

Mechanical design

Mounting THT soldering in PCB
Illumination fully illuminated
1 LED
LED colour see order block
LED type 2 mm

Other specifications

Ambient temp. operating min. -25 °C
Ambient temp. operating max. +70 °C
Environmental resistance acc. to IEC 60068-2
-14, -30, -33 and -78
according to E DIN
IEC 600 28-2-20
Solderability / solder heat resistance 260 °C max.
Wave soldering 350 °C / 5 sec. max.
Manual soldering

4

RF

Dimensional Drawing Signal Indicator RF 15

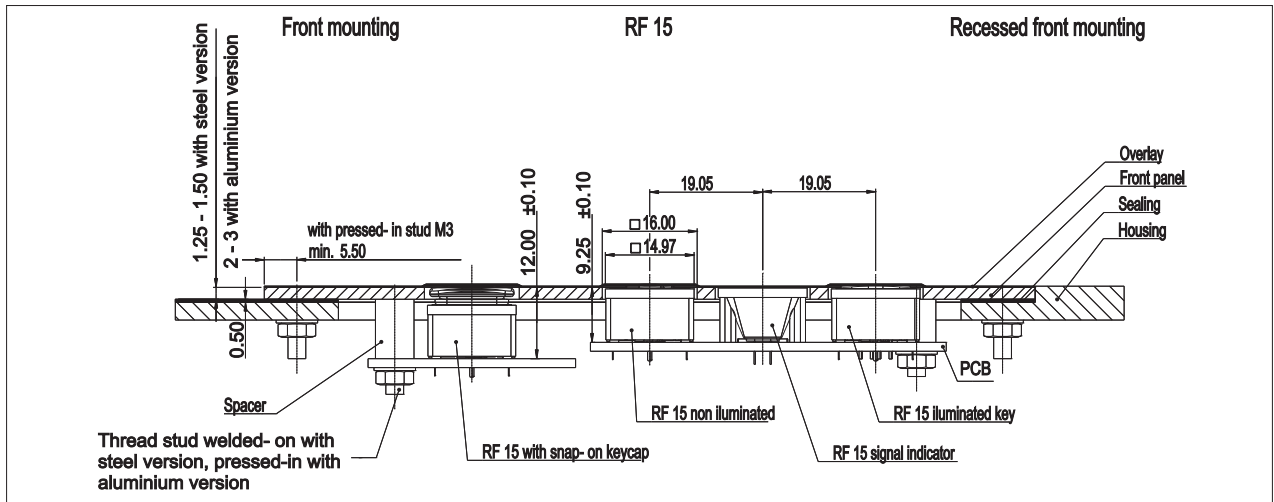

Hole Pattern

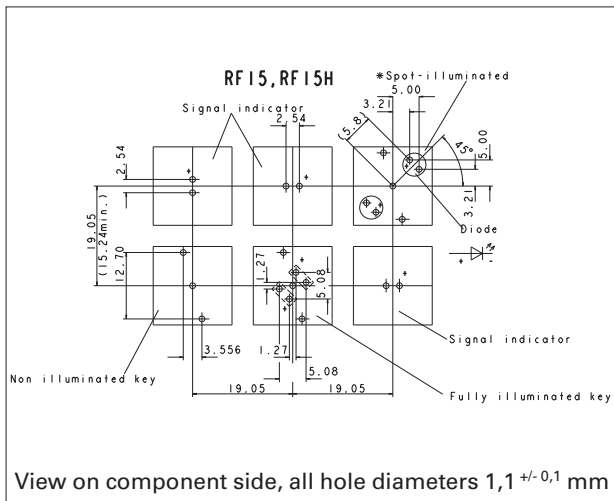

Hole Pattern – Front Panel

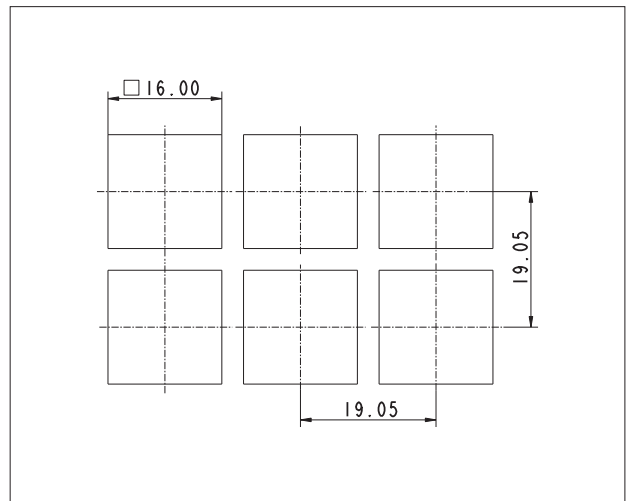

4

RF

RF 15 - Signal indicator, fully illuminated, 1 LED

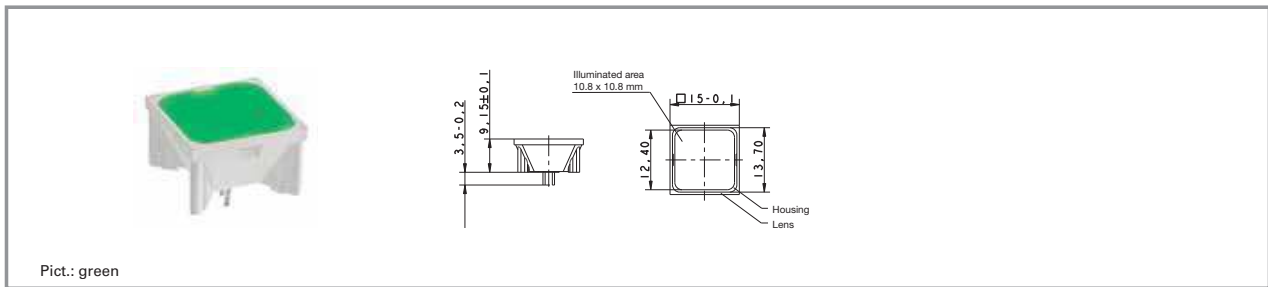

Overall height	Illumination	Colour of lens	LED colour	LED type	Order no.
9.7 mm	fully illuminated 1 LED	red	red	2 mm	3.14.200.051/0000
9.7 mm	fully illuminated 1 LED	green	green	2 mm	3.14.200.052/0000
9.7 mm	fully illuminated 1 LED	yellow	yellow	2 mm	3.14.200.053/0000
9.7 mm	fully illuminated 1 LED	orange	yellow	2 mm	3.14.200.054/0000
9.7 mm	fully illuminated 1 LED	blue	blue	2 mm	3.14.200.055/0000

Technical data see page 4 - 62

Technical data of LED see separate page at the beginning of chapter 4 PCB Keyswitches.

4

RF

RF 19 - Short-travel keyswitch



General Data

Application notes:

RF 19 keys offer a large actuation area. When designing low-profile keyboards with a grid of ≥ 23 mm, frame webs remain free between the individual keys.

The overlay can be glued onto these frame webs; we recommend area embossing over the keys for the overlay.

Technical Data

4

General information

Colour of lens see order block
Recommended key grid 23 mm

Dimensions

Length 19.05 mm
Width 19.05 mm
Overall height 9.7 mm

Mechanical design

Mounting soldering in PCB
Terminals THT
Contact system snap-action contact
Contact arrangement 1 NO
Contact materials see order block
Illumination see order block
LED colour see order block
LED type see order block

Mechanical characteristics

Operating force max. $2.9^{+0.6}$ N
Switching travel $0.5^{+0.2}$ mm
Robustness min. with through-plated PCB 100 N

Electrical characteristics

Rated voltage min. Au: 0.02 V, Ag: 3 V
Rated voltage max. Au: 35 V, Ag: 50 V
Rated current min. Au: 0.01 mA, Ag: 0.1 mA
Rated current max. Au: 100 mA, Ag: 250 mA
Rated power max. (ohmic load) Au: 2 W, Ag: 12.5 W
Contact resistance when new max. 100 m Ω
Insulation resistance $10^9 \Omega$

Other specifications

Ambient temp. operating min. -25 °C
Ambient temp. operating max. +70 °C
Environmental resistance acc. to IEC 60068-2 -14, -30, -33 and -78 1,000,000
Operating life min. (operations) 1,000,000
Solderability / solder heat resistance according to E DIN IEC 600 28-2-20
Wave soldering 260 °C max.
Manual soldering 350 °C / 5 sec. max.

RF

Force/Travel Diagram – Keyswitch RF 19

Operation characteristic limits RF

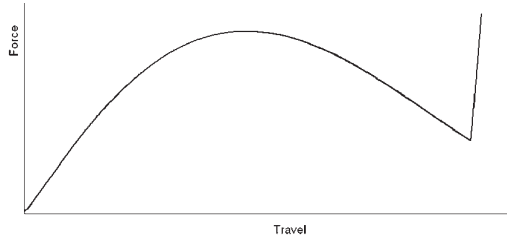

Circuit Diagram – Keyswitch RF 19

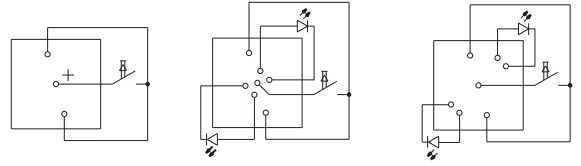

Keyswitch, non-illuminated

Keyswitch, fully illuminated

Keyswitch, spot-illuminated

Dimensional Drawing

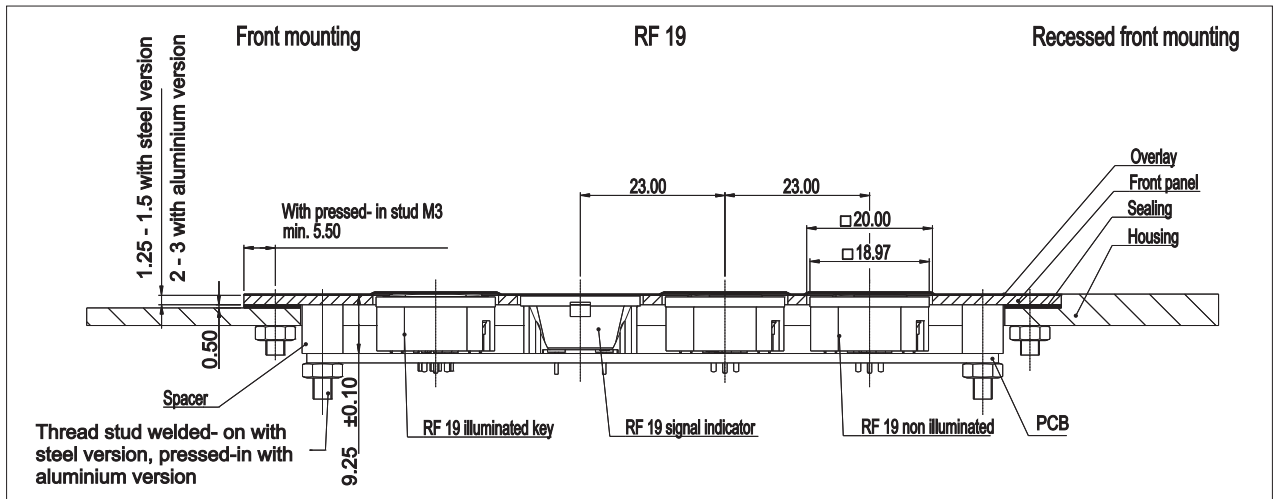

4

RF

Hole Patterns RF 19

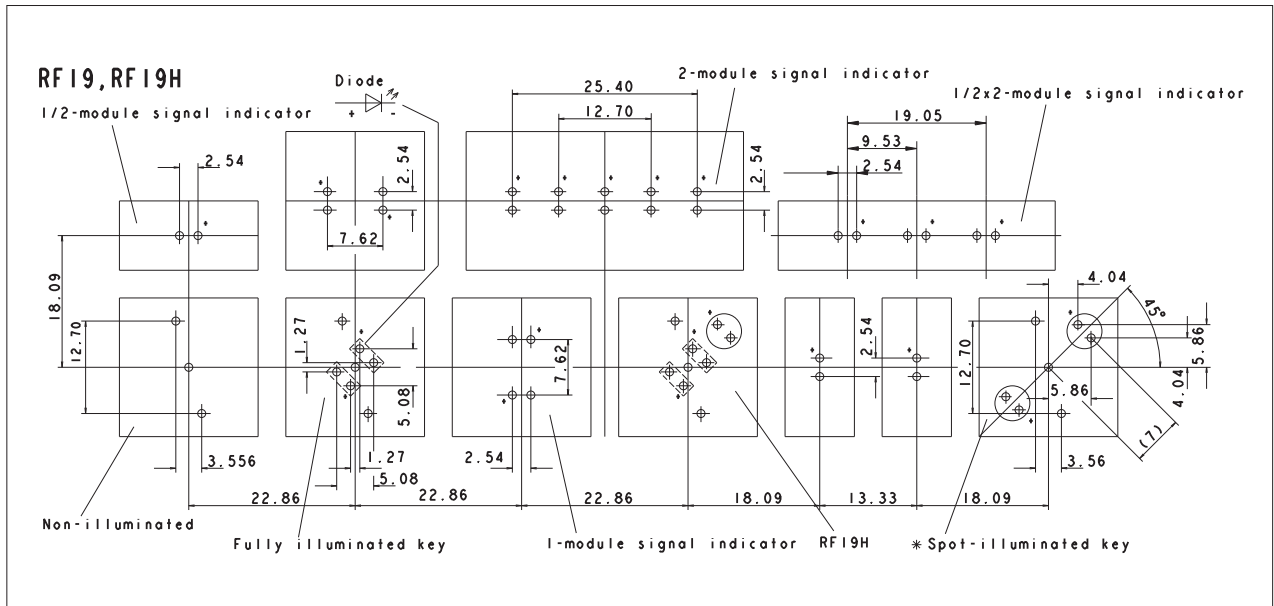

*The LED may be positioned either on the left-hand or right-hand side.
Standard version: LED on left-hand side
View on component side, all hole diameters 1.1 +/- 0.1 mm

Hole Patterns – Front Panel RF 19

4

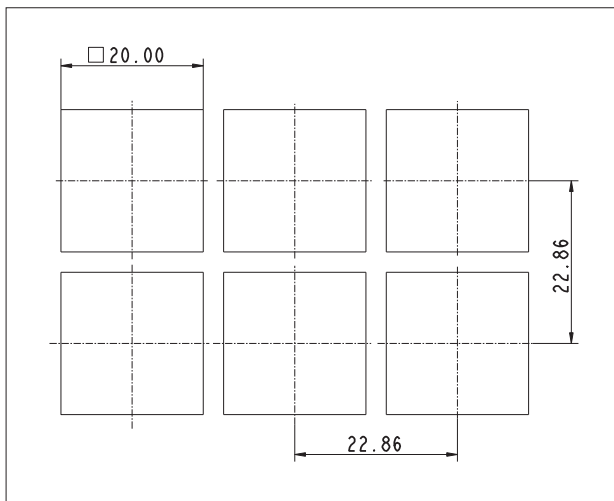

RF

RF 19 - Short-travel keyswitch, non-illuminated

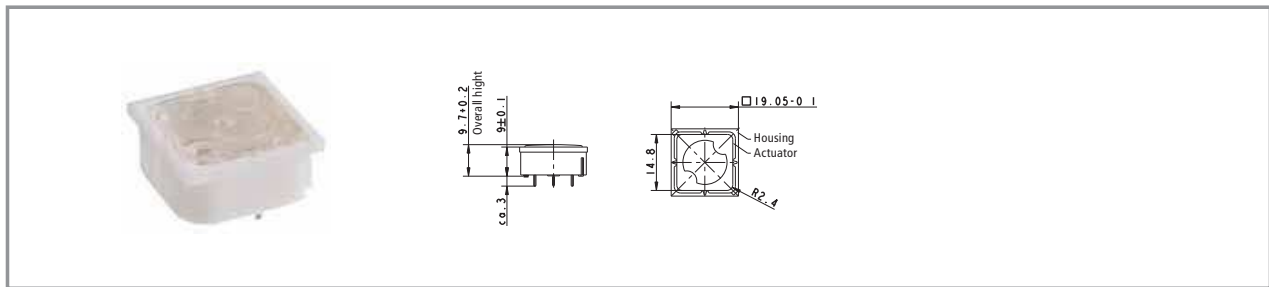

Contact materials	Illumination	Colour of lens	LED colour	LED type	Order no.
Au	not illuminated	transparent	-	-	3.14.001.001/0000
Ag	not illuminated	transparent	-	-	3.14.001.006/0000

Technical data see page 4 - 66

RF 19 - Short-travel keyswitch, fully illuminated with 2 LED

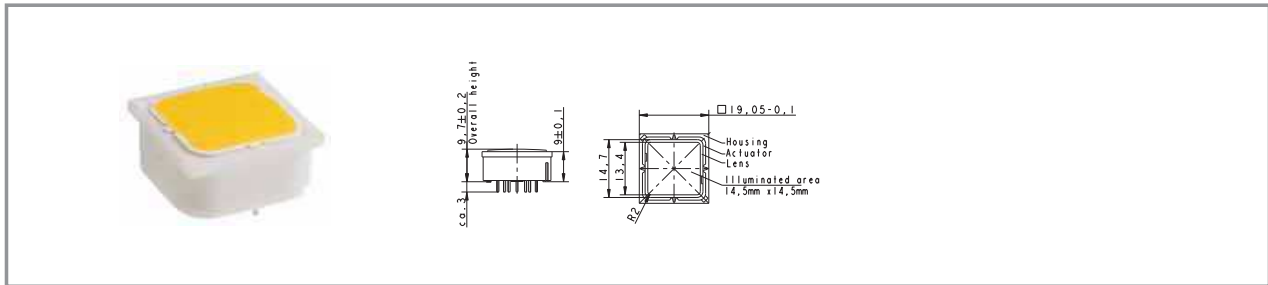

Contact materials	Illumination	Colour of lens	LED colour	LED type	Order no.
Au	fully illuminated 2 LED	red	red	2 mm	3.14.002.011/0000
Au	fully illuminated 2 LED	green	green	2 mm	3.14.002.012/0000
Au	fully illuminated 2 LED	opaque white	green	2 mm	3.14.002.901/0000
Au	fully illuminated 2 LED	yellow	yellow	2 mm	3.14.002.013/0000
Au	fully illuminated 2 LED	orange	yellow	2 mm	3.14.002.014/0000
Au	fully illuminated 2 LED	blue	blue	2 mm	3.14.002.015/0000
Ag	fully illuminated 2 LED	red	red	2 mm	3.14.002.021/0000
Ag	fully illuminated 2 LED	green	green	2 mm	3.14.002.022/0000
Ag	fully illuminated 2 LED	yellow	yellow	2 mm	3.14.002.023/0000
Ag	fully illuminated 2 LED	orange	yellow	2 mm	3.14.002.024/0000
Ag	fully illuminated 2 LED	blue	blue	2 mm	3.14.002.025/0000
Ag	fully illuminated 2 LED	opaque white	green	2 mm	3.14.002.944/0000
Ag	fully illuminated 2 LED	white	green	2 mm	3.14.002.026/0000
Ag	fully illuminated 2 LED	white	yellow	2 mm	3.14.002.027/0000

Technical data see page 4 - 66

Technical data of LED see separate page at the beginning of this chapter.

4

RF

RF 19 - Short-travel keyswitch, 1 LED spot-illumination

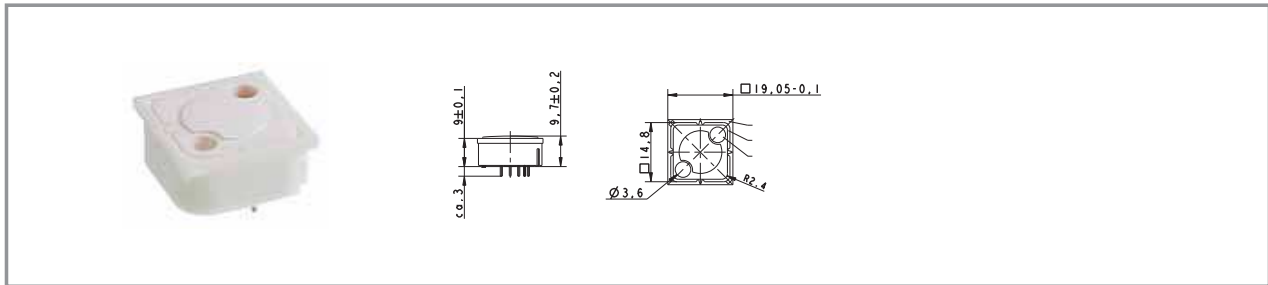

Contact materials	Illumination	Colour of lens	LED colour	LED type	Order no.
Au	spot illumination 1 LED	opaque white	blue	3 mm	3.14.001.030/0000
Au	spot illumination 1 LED	opaque white	red	3 mm	3.14.001.031/0000
Au	spot illumination 1 LED	opaque white	green	3 mm	3.14.001.032/0000
Au	spot illumination 1 LED	opaque white	yellow	3 mm	3.14.001.033/0000
Ag	spot illumination 1 LED	opaque white	blue	3 mm	3.14.001.040/0000
Ag	spot illumination 1 LED	opaque white	red	3 mm	3.14.001.041/0000
Ag	spot illumination 1 LED	opaque white	green	3 mm	3.14.001.042/0000
Ag	spot illumination 1 LED	opaque white	yellow	3 mm	3.14.001.043/0000

Technical data see page 4 - 66

Versions with 2 LEDs available on request.

Technical data of LED see separate page at the beginning of this chapter.

RF 19 H - Short-travel keyswitch



General Data

Application notes:

The RF 19H key has an overall height of 12.5 mm and can be fully illuminated. When designing membrane keyboards, we recommend using a key grid of at least 24 mm and a 0.13 mm overlay with area embossing over the keys. You can use the O-ring (accessory) to block the key and use it as an indicator field or blank spaceholder.

Technical Data

4

General information

Colour of lens see order block
Recommended key grid 24 mm

Dimensions

Length 19.05 mm
Width 19.05 mm
Overall height 12.5 mm

Mechanical design

Mounting soldering in PCB
Terminals THT
Contact system snap-action contact
Contact arrangement 1 NO
Contact materials see order block
Illumination see order block
LED colour see order block
LED type see order block

Mechanical characteristics

Operating force max. 2.9^{+0.6} N
Switching travel 0.5^{+0.2} mm
Robustness min. with through-plated PCB 100 N

Electrical characteristics

Rated voltage min. Au: 0.02 V, Ag: 3 V
Rated voltage max. Au: 35 V, Ag: 50 V
Rated current min. Au: 0.01 mA, Ag: 0.1 mA
Rated current max. Au: 100 mA, Ag: 250 mA
Rated power max. (ohmic load) Au: 2 W, Ag: 12.5 W
Contact resistance when new max. 100 mΩ
Insulation resistance 10⁹ Ω

Other specifications

Ambient temp. operating min. -25 °C
Ambient temp. operating max. +70 °C
Environmental resistance acc. to IEC 60068-2 -14, -30, -33 and -78
Operating life min. (operations) 1,000,000
Solderability / solder heat resistance according to E DIN IEC 600 28-2-20
Wave soldering 260 °C max.
Manual soldering 350 °C / 5 sec. max.

RF

Force/Travel Diagram – Keyswitch RF 19 H

Operation characteristic limits RF

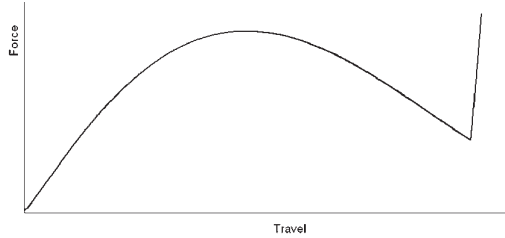

Circuit Diagram – Keyswitch RF 19 H

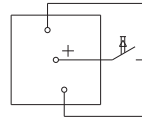

Keyswitch,
non illuminated

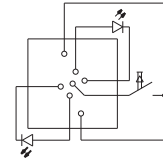

Keyswitch,
fully illuminated

Dimensional Drawing

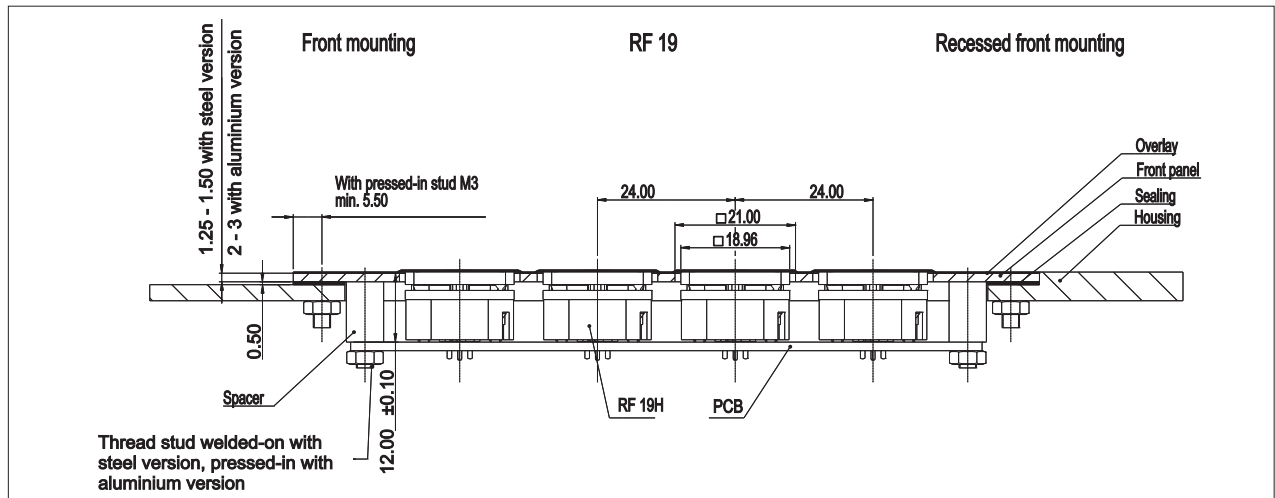

4

RF

Hole Pattern RF 19 H

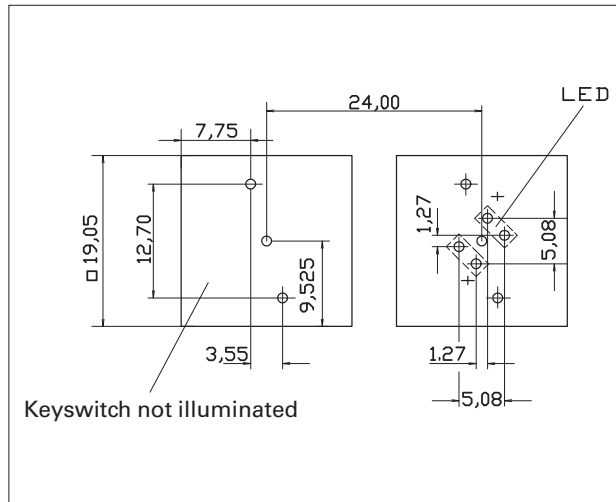

Hole Pattern – Front Panel RF 19 H

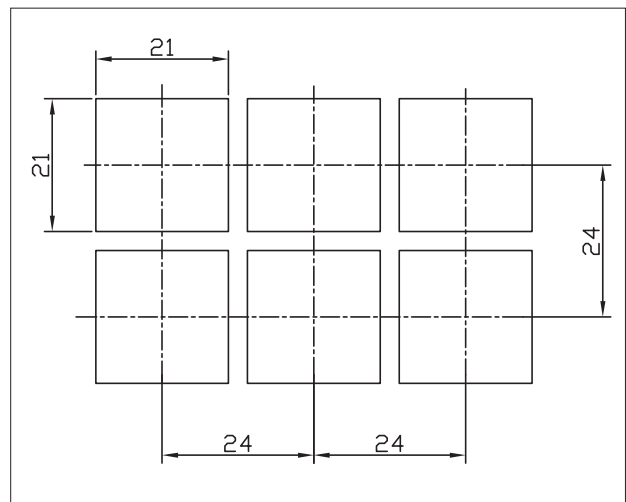

The LED may be positioned either on the left-hand or right-hand side.
 Standard version: LED on left-hand side
 View on component side, all hole diameters 1.1 +/- 0.1 mm

4

Typical accessories RF 19 H - Short-travel keyswitch

Description	Photo	Order no.	Additional accessories see page
O-ring, black, 16.0 x 1, for blocking RF 19H keys		5.30.125.007/0100	5 - 25

RF 19 H - Keyswitch, non-illuminated

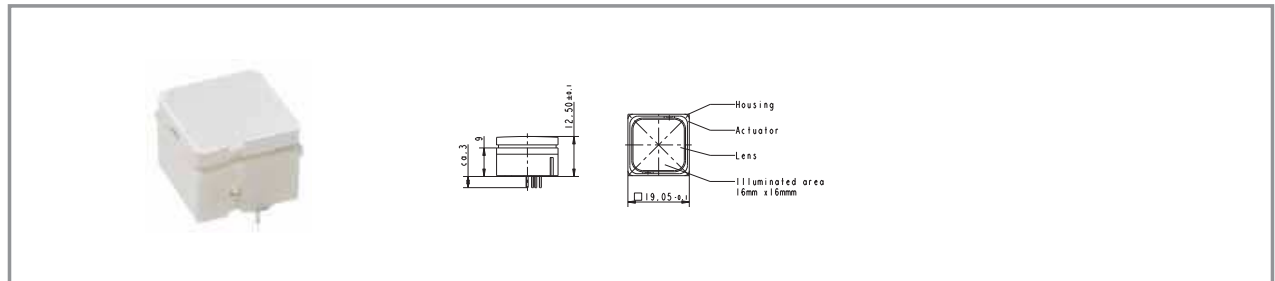

RF

Contact materials	Illumination	Colour of lens	LED colour	LED type	Order no.
Au	not illuminated	white	-	-	3.14.001.501/0000
Ag	not illuminated	white	-	-	3.14.001.506/0000

Technical data see page 4 - 72

RF 19 H - Short-travel keyswitch, fully illuminated

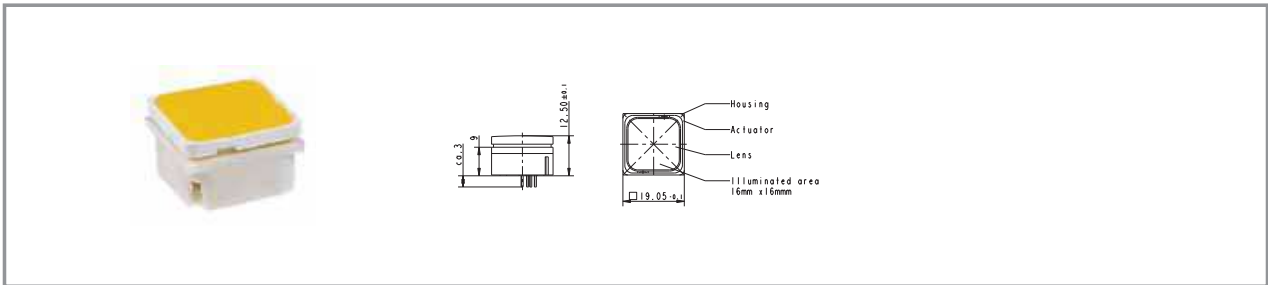

Contact materials	Illumination	Colour of lens	LED colour	LED type	Order no.
Au	fully illuminated 2 LED	red	red	2 mm	3.14.002.613/0000
Au	fully illuminated 2 LED	green	green	2 mm	3.14.002.632/0000
Au	fully illuminated 1 LED	green	green super bright	3 mm	3.14.002.633/0000
Au	fully illuminated 2 LED	yellow	yellow	2 mm	3.14.002.653/0000
Au	fully illuminated 1 LED	white	white	3 mm	3.14.002.684/0000
Au	fully illuminated 2 LED	orange	yellow	2 mm	3.14.002.673/0000
Au	fully illuminated 2 LED	white	multi colour	3 mm	3.14.001.672/0000
Au	fully illuminated 1 LED	blue	blue	3 mm	3.14.002.683/0000
Ag	fully illuminated 2 LED	red	red	2 mm	3.14.002.623/0000
Ag	fully illuminated 2 LED	green	green	2 mm	3.14.002.642/0000
Ag	fully illuminated 1 LED	green	green super bright	3 mm	3.14.002.643/0000
Ag	fully illuminated 1 LED	blue	blue	3 mm	3.14.002.688/0000
Ag	fully illuminated 2 LED	yellow	yellow	2 mm	3.14.002.663/0000
Ag	fully illuminated 1 LED	white	white	3 mm	3.14.002.689/0000
Ag	fully illuminated 2 LED	orange	yellow	2 mm	3.14.002.678/0000
Ag	fully illuminated 2 LED	white	multi colour	3 mm	3.14.001.682/0000

4

RF

Technical data see page 4 - 72

When using the keyswitches with multicolour LEDs the illumination colour can be varied from red to green by change of polarity. Due to the frequency of the polarity-changes the colours red, green, yellow as well as all secondary colours from these are possible.

Technical data of LED see separate page at the beginning of this chapter.

RF 19 - Signal indicator

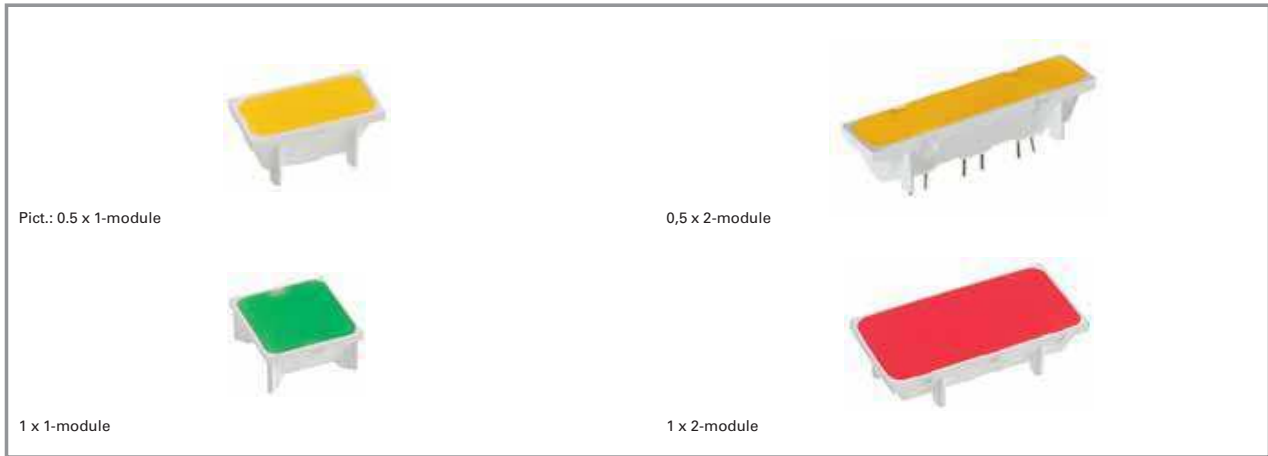

Technical Data

General information

Colour of lens see order block
 Recommended key grid 23/x mm

Dimensions

Length see order block
 Width see order block
 Overall height 9.15 mm

Mechanical design

Mounting THT soldering in PCB
 Illumination see order block
 LED colour see order block
 LED type see order block

Other specifications

Ambient temp. operating min. -25 °C
 Ambient temp. operating max. +70 °C
 Environmental resistance acc. to IEC 60068-2
 -14, -30, -33 and -78
 according to E DIN
 IEC 600 28-2-20
 Solderability / solder heat resistance 260 °C max.
 Wave soldering 350 °C / 5 sec. max.
 Manual soldering

4

RF

Dimensional Drawing Signal Indicator RF 19

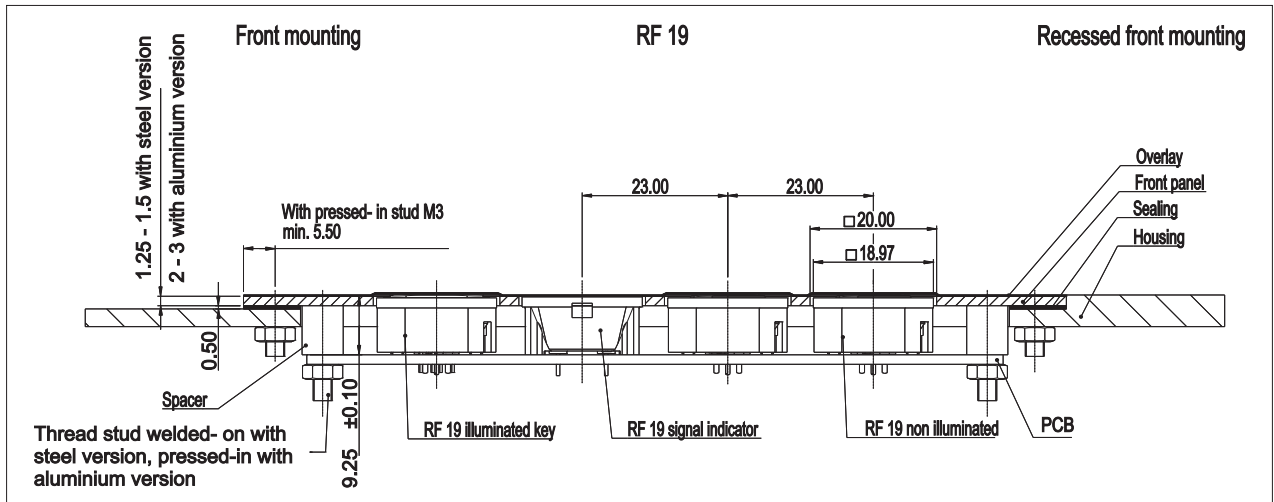

Hole Pattern RF 19

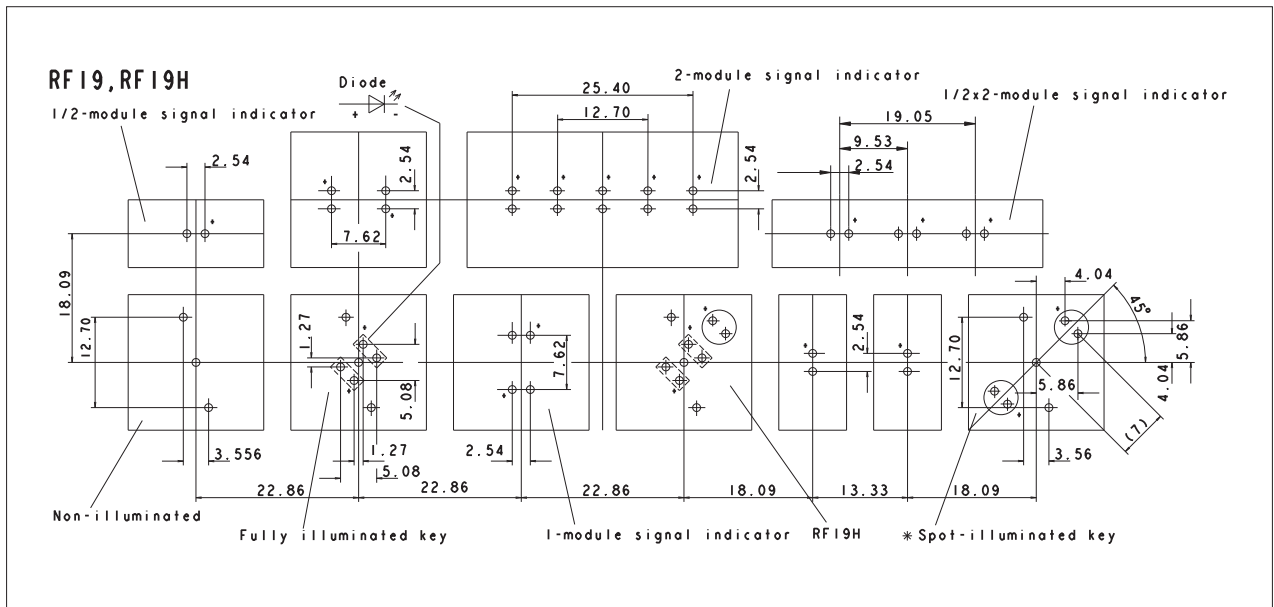

*The LED may be positioned either on the left-hand or right-hand side.
Standard version: LED on left-hand side
View on component side, all hole diameters 1.1 +/- 0.1 mm

Front panel cut-out = outer keyswitch size + 1 mm

4

RF

RF 19 - Signal indicator, 1/2 x 1-module

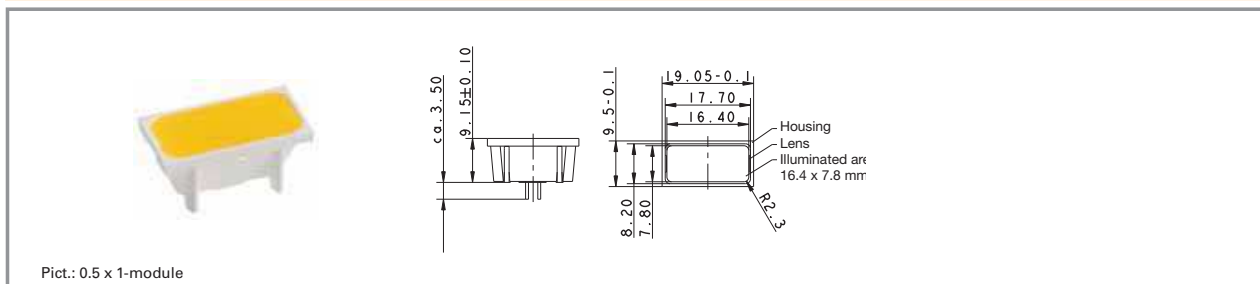

Pict.: 0.5 x 1-module

Illumination	Colour of lens	LED colour	LED type	Order no.
fully illuminated 1 LED	red	red	2 mm	3.14.002.061/0000
fully illuminated 1 LED	green	green	2 mm	3.14.002.062/0000
fully illuminated 1 LED	yellow	yellow	2 mm	3.14.002.063/0000
fully illuminated 1 LED	orange	yellow	2 mm	3.14.002.064/0000

Technical data see page 4 - 76

Technical data of LED see separate page at the beginning of chapter 4 PCB Keyswitches.

4

RF 19 - Signal indicator, 1/2 x 2-module

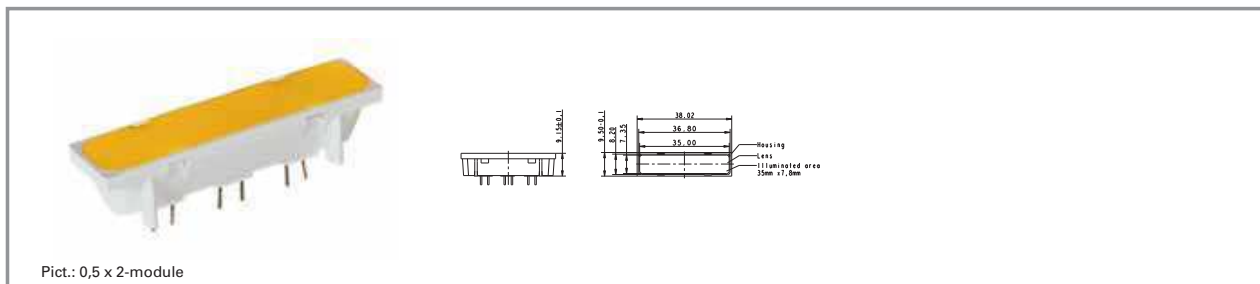

Pict.: 0,5 x 2-module

Illumination	Colour of lens	LED colour	LED type	Order no.
fully illuminated 3 LED	red	red	2 mm	3.14.002.908/0000
fully illuminated 3 LED	green	green	2 mm	3.14.002.909/0000
fully illuminated 3 LED	yellow	yellow	2 mm	3.14.002.910/0000
fully illuminated 3 LED	orange	yellow	2 mm	3.14.002.911/0000

Technical data see page 4 - 76

Technical data of LED see separate page at the beginning of chapter 4 PCB Keyswitches.

RF

RF 19 - Signal indicator, 1 x 1-module

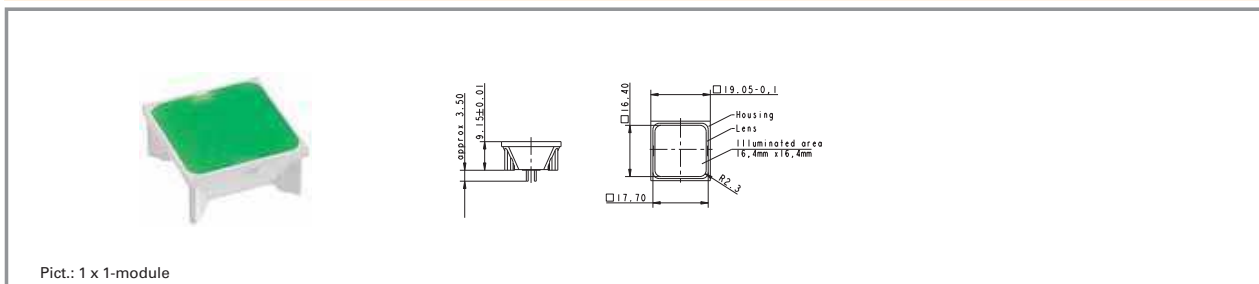

illumination	Colour of lens	LED colour	LED type	Order no.
fully illuminated 2 LED	red	red	2 mm	3.14.002.051/0000
fully illuminated 2 LED	green	green	2 mm	3.14.002.052/0000
fully illuminated 2 LED	yellow	yellow	2 mm	3.14.002.053/0000
fully illuminated 2 LED	orange	yellow	2 mm	3.14.002.054/0000
fully illuminated 2 LED	blue	blue	2 mm	3.14.001.659/0000

Technical data see page 4 - 76

For technical data of the LED see separate page at the beginning of chapter „RF short-travel keyswitches“

Suitable for RK 90 system design, illuminated for 2-module keycap.

RF 19 - Signal indicator, 1 x 2-module

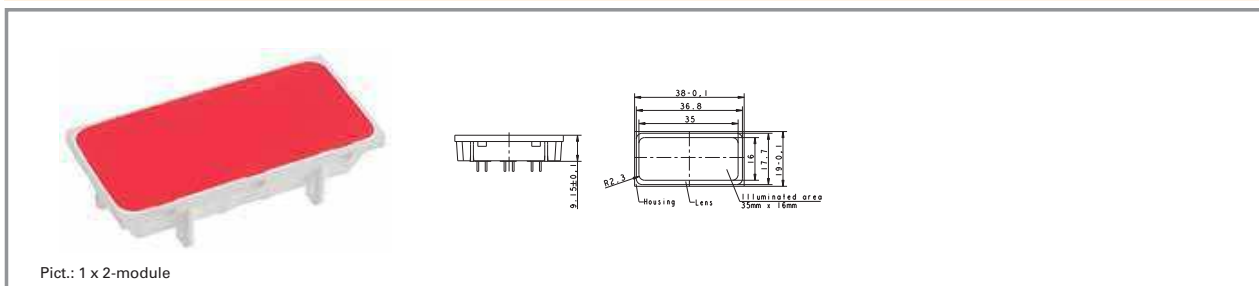

illumination	Colour of lens	LED colour	LED type	Order no.
fully illuminated 5 LED	red	red	2 mm	3.14.002.071/0000
fully illuminated 5 LED	green	green	2 mm	3.14.002.072/0000
fully illuminated 5 LED	yellow	yellow	2 mm	3.14.002.073/0000
fully illuminated 5 LED	orange	yellow	2 mm	3.14.002.074/0000

Technical data see page 4 - 76

For technical data of the LED see separate page at the beginning of chapter „RF short-travel keyswitches“

RF 15/19 - Special accessories



Technical Data

Dimensions

Length	see order block	Overall height	see order block
Width	see order block	Diameter	see order block
		Colour	see order block

RF 15 N - Extension plunger, round head

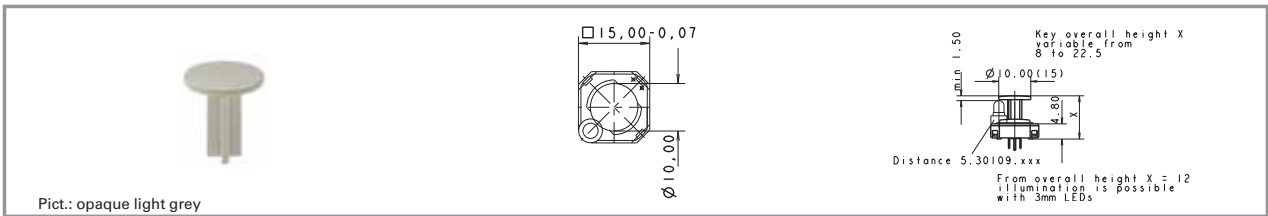

4

Length	Width	Overall height	Diameter	Colour	Order no.
-	-	9 mm	10 mm	-	5.46.011.036/0710
-	-	9.7 mm	10 mm	-	5.46.011.030/0710
-	-	12.5 mm	10 mm	-	5.46.011.037/0710
-	-	13 mm	10 mm	-	5.46.011.038/0710
-	-	22.5 mm	10 mm	-	5.46.011.028/0710

RF

Length of plunger = Overall height - 4.25 mm.

RF 15 N - Extension plunger, round head, with recess for LED

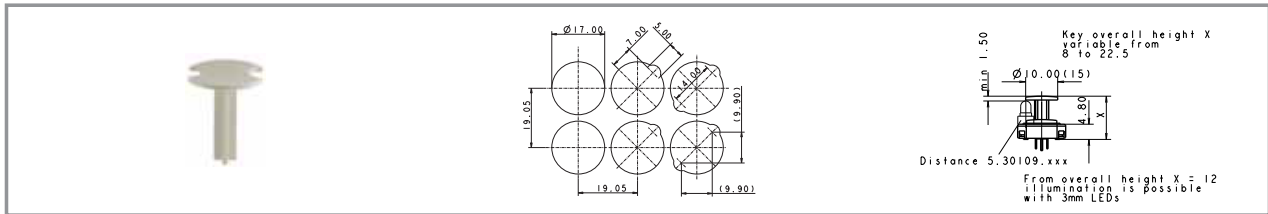

Length	Width	Overall height	Diameter	Colour	Order no.
-	-	9 mm	15 mm	-	5.46.017.036/0710
-	-	9.7 mm	15 mm	-	5.46.017.030/0710
-	-	12.5 mm	15 mm	-	5.46.017.037/0710
-	-	22.5 mm	15 mm	-	5.46.017.028/0710
-	-	13 mm	15 mm	-	5.46.017.038/0710

Technical data see page 4 - 80

Length of plunger = Overall height - 4.25 mm.

RF 15 - Keycap, snap-on, for overall height 12.5 mm

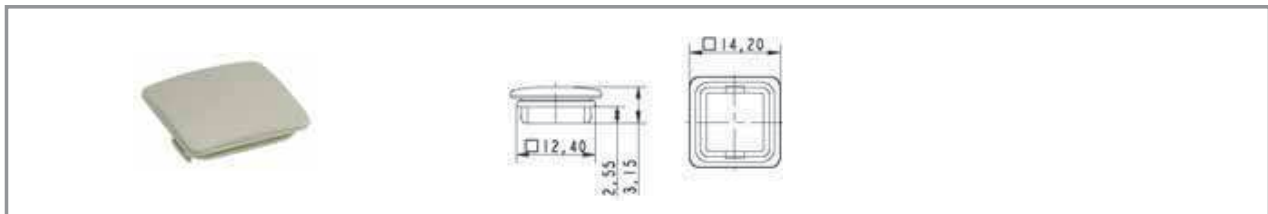

Length	Width	Overall height	Diameter	Colour	Order no.
14.2 mm	14.2 mm	12.5 mm	-	beige	5.46.654.059/0227

Technical data see page 4 - 80

4

RF

Spacers, round

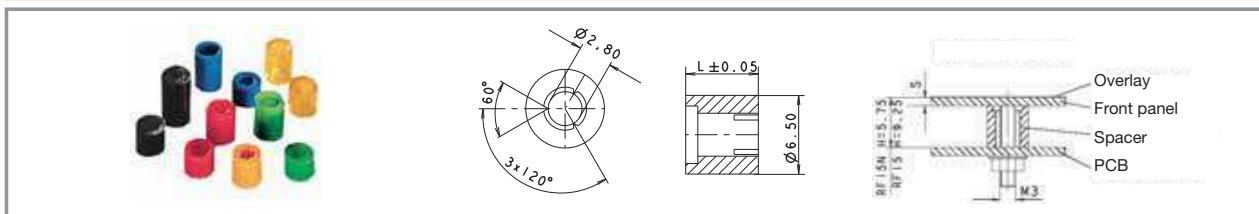

Length	Width	Overall height	Diameter	Colour	Order no.
3.50 mm	-	-	-	blue transparent	5.30.759.023/0000
4 mm	-	-	-	green	5.30.759.025/0000
4.25 mm	-	-	-	blue	5.30.759.026/0000
4.50 mm	-	-	-	red	5.30.759.027/0000
4.75 mm	-	-	-	blue transparent	5.30.759.028/0000
5 mm	-	-	-	black	5.30.759.029/0000
5.25 mm	-	-	-	yellow orange transparent	5.30.759.030/0000
5.50 mm	-	-	-	yellow	5.30.759.031/0000
5.75 mm	-	-	-	green	5.30.759.032/0000
6 mm	-	-	-	blue	5.30.759.033/0000
6.2 mm	-	-	-	blue	5.30.759.251/0000
6.25 mm	-	-	-	red	5.30.759.034/0000
6.50 mm	-	-	-	blue transparent	5.30.759.035/0000
6.75 mm	-	-	-	black	5.30.759.036/0000
7 mm	-	-	-	yellow orange transparent	5.30.759.037/0000
7.25 mm	-	-	-	yellow	5.30.759.038/0000
7.50 mm	-	-	-	green	5.30.759.039/0000
7.75 mm	-	-	-	blue	5.30.759.040/0000
8 mm	-	-	-	red	5.30.759.041/0000
8.25 mm	-	-	-	blue transparent	5.30.759.042/0000
10.00 mm	-	-	-	black	5.30.759.043/0104

Technical data see page 4 - 80

Required spacer length = Overall height of key - front panel thickness - 0.5 mm (area embossing).

4

RF

Spacers, triangular

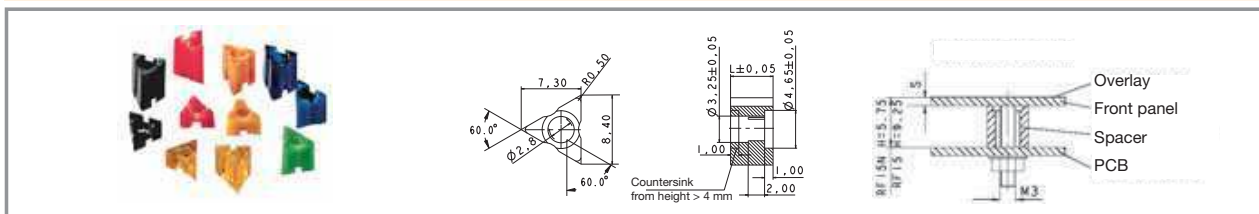

Length	Width	Overall height	Diameter	Colour	Order no.
2.50 mm	-	-	-	blue	5.30.759.094/0000
2.75 mm	-	-	-	red	5.30.759.095/0000
3 mm	-	-	-	blue transparent	5.30.759.096/0000
3.25 mm	-	-	-	black	5.30.759.097/0000
3.50 mm	-	-	-	yellow orange transparent	5.30.759.098/0000
3.75 mm	-	-	-	yellow	5.30.759.099/0000
4 mm	-	-	-	green	5.30.759.100/0000
4.25 mm	-	-	-	blue	5.30.759.101/0000
4.50 mm	-	-	-	red	5.30.759.102/0000
4.75 mm	-	-	-	blue transparent	5.30.759.103/0000
5 mm	-	-	-	black	5.30.759.104/0000
5.25 mm	-	-	-	yellow orange transparent	5.30.759.105/0000
5.50 mm	-	-	-	yellow	5.30.759.106/0000
5.75 mm	-	-	-	green	5.30.759.107/0000
6 mm	-	-	-	blue	5.30.759.108/0000
6.2 mm	-	-	-	blue	5.30.759.253/0000
6.25 mm	-	-	-	red	5.30.759.109/0000
6.50 mm	-	-	-	blue transparent	5.30.759.110/0000
6.75 mm	-	-	-	black	5.30.759.111/0000
7 mm	-	-	-	yellow orange transparent	5.30.759.112/0000
7.25 mm	-	-	-	yellow	5.30.759.113/0000
7.50 mm	-	-	-	green	5.30.759.114/0000
7.75 mm	-	-	-	blue	5.30.759.115/0000

4

RF

Length	Width	Overall height	Diameter	Colour	Order no.
8 mm	-	-	-	red	5.30.759.116/0000
8.25 mm	-	-	-	blue transparent	5.30.759.117/0000
9 mm	-	-	-	blue	5.30.759.254/0000
10.00 mm	-	-	-	black	5.30.759.124/0000
10.25 mm	-	-	-	yellow orange transparent	5.30.759.125/0000

Technical data see page 4 - 80

Required spacer length = Overall height of key - front panel thickness - 0.5 mm (area embossing).

RF 15 N - LED spacer



Length	Width	Overall height	Diameter	Colour	Order no.
2.2 mm	-	12.5 mm	5 mm	light grey	5.30.109.010/0756
12 mm	-	22.5 mm	5 mm	black	5.30.109.019/0105

Technical data see page 4 - 80

4

RF



General Data

Short-travel main switch for use in membrane keyboards under the overlay or with RK 90 keycaps, 250V, 4A max.
A cut-out in the overlay is not required!

Content

KN 19 - Short-travel main switch
KN 19 - Short-travel main switch

4 - 86
4 - 88

4

**KN
19**

KN 19 - Short-travel main switch



General Data

The KN 19 makes it possible to implement a power switch directly in a low-profile data entry system. This eliminates the need for extra switches on the device and additional openings in the overlay. In this way, you can achieve an optimum of safety and a consistent design.

The contact opening widths comply with the VDE standards. The KN 19 can also be employed underneath RK 90 keycaps. Other actuation functions (momentary, latching/momentary) available on request.

Technical Data

4

General information

Recommended key grid 19.05 x 38.1 mm

Dimensions

Length 37.8 mm
 Width 18.8 mm
 Overall height 9.7 mm

Mechanical design

Mounting on PCB
 Terminals THT solder terminals
 Contact system snap-action bridge contact
 Contact arrangement see order block
 Contact materials Ag
 Illumination 1 LED (max. 3 mm) possible
 Degree of protection IP40
 Hot wire ignition acc. to IEC 60695-2-1 850 °C

Mechanical characteristics

Operating force max. 9±3 N
 Operating travel 0.55±0.15 mm
 Robustness max. 100 N

Electrical characteristics

Rated voltage AC min. 12 V
 Rated voltage DC min. 12 V
 Rated voltage AC max. 250 V
 Rated voltage DC max. 50 V
 Ohmic load AC 6 A
 Ohmic load DC min. 0.1 A
 Ohmic load DC max. 10 A
 Contact resistance when new max. 50 mΩ
 Capacity input current AC max. 100 A
 Rated motor current AC 4 A
 Rated filament lamp current AC 2.4 A
 Bouncing time max. 10 ms

Other specifications

Ambient temp. operating min. -25 °C
 Ambient temp. operating max. +70 °C
 Environmental resistance acc. to IEC 60068-2 -14, -30, -33 and -78
 Operating life AC AC 250 V: 200.000/2 A; 100.000 /6 A
 Operating life DC 50,000(10 A / 50 V=)
 Soldering time max. 3 s
 Soldering temperature max. 350 °C
 Flame class acc. to UL 94 UL 94 VO

KN 19

Circuit Diagram

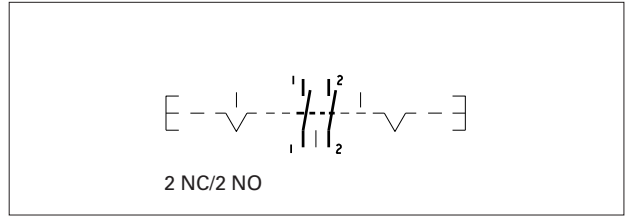
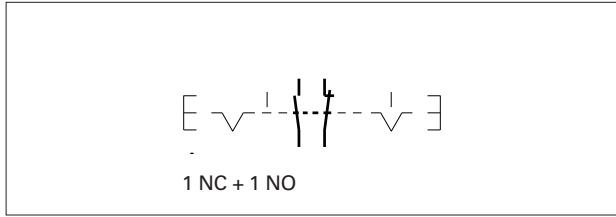

Dimensional Drawing

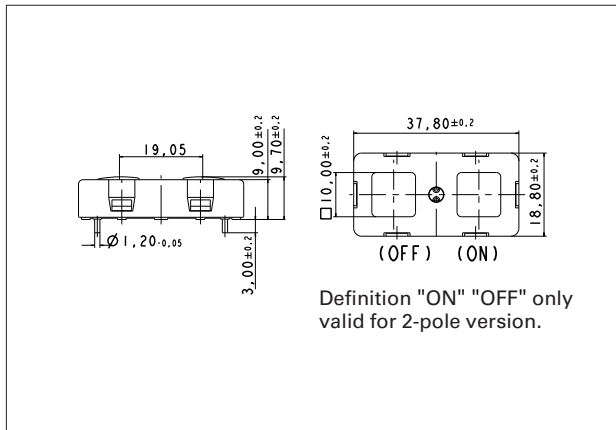

Hole Pattern

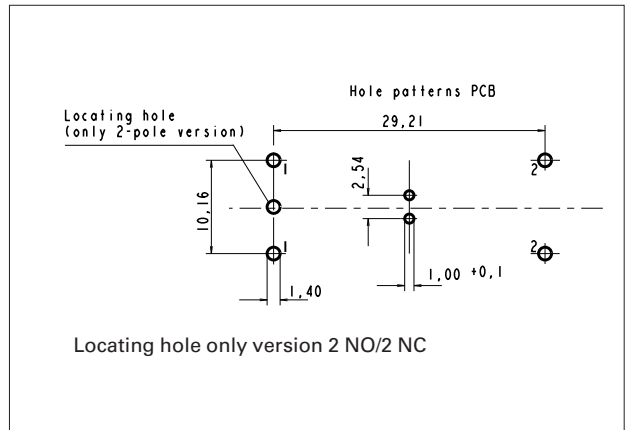

View on component side.

Approvals



IEC 61058

UL 508, C22.2 No. 14-M91

Approvals



IEC 61058

UL 508, C22.2 No. 14-M91

Typical accessories KN 19 - Short-travel main switch

Description	Photo	Order no.	Additional accessories see page
KN19 - Absorption rubber		5.30.729.009/0000	

KN 19 - Short-travel main switch



Pict.: 1 NC + 1 NO

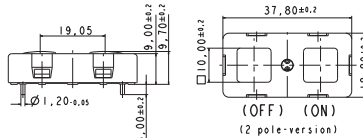

4

Contact arrangement	Rated voltage AC max.	Order no.
1 NC + 1 NO	250 V	1.12.000.001/0000
2 NC / 2 NO	250 V	1.12.000.501/0000

Technical data see page 4 - 86

Accessoires:

KN19 - Absorption rubber: 5.30.729.009/0000

For keycaps, refer to RK 90 system design.

Positive opening NC contacts to IEC 60 947-5-1.

1-LED spot-illumination (max. 3 mm) possible.

KN
19

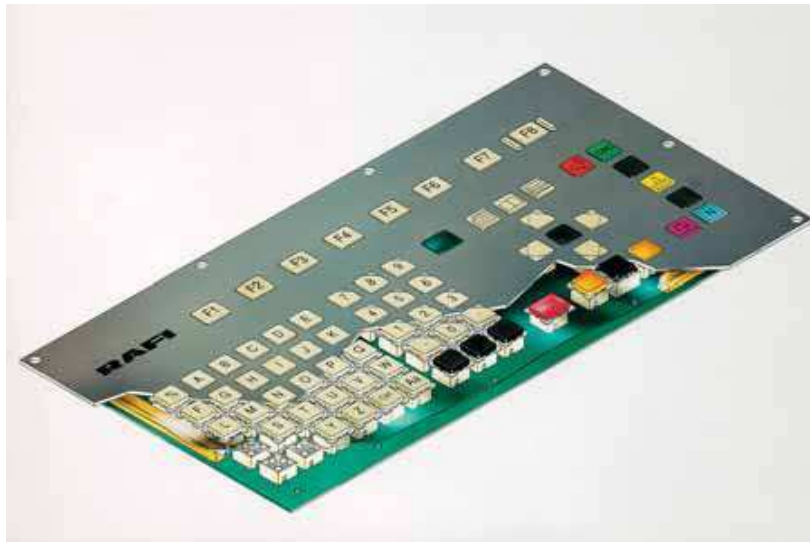

General Data

Keycaps for RACON, RF 15 / RF 19 and KN 19 short-travel keyswitches

- You can insert a legend insert between lens and pressure pool of the transparent keycaps.

Content

RK 90 - Keycaps, plastic, 9 x 9 mm	4 - 92
RK 90 - Keycap body plastic, for lenses 9 x 9 mm	4 - 93
RK 90 - Keycaps, plastic, 14 mm	4 - 94
RK 90 - Keycap body plastic, for lenses 14 mm, 1-module	4 - 95
RK 90 - Keycap body plastic, for lenses 1¼-module	4 - 95
RK 90 - Keycap body plastic, for lenses 14 mm, 1½-module	4 - 96
RK 90 - Keycap body plastic, for lenses 2-module	4 - 96
RK 90 - Keycaps, aluminum, 14 x 14 mm	4 - 98
RK 90 - Keycaps, aluminum, 14 mm, 1-module	4 - 98
RK 90 - Keycaps, aluminum, 14 mm, 1½-module	4 - 99
RK 90 - Keycaps, aluminum, 14 mm, 2-module	4 - 99
RK 90 - Special accessories	4 - 100
RK 90 - Fin, to avoid inadvertent operation	4 - 100
RK 90 - Spacer M 4	4 - 101
RK 90 - Silicone foil 600 x 590 x 0.45 mm	4 - 101

Keycap system RK 90

Example with RF 15 keyswitches. Instead of RF 15 following keyswitches can be used:

- MICON 5
- RACON 8/12
- RF 15 keyswitches and signal indicators
- RF 19 keyswitches and signal indicators
- Short-travel main switch KN 19

The RK 90 system was granted the prize of the Design Forum of the Hannover Fair.

Degree of protection: IP65 according to DIN in front of the panel, with silicone sealing.

Installation methods

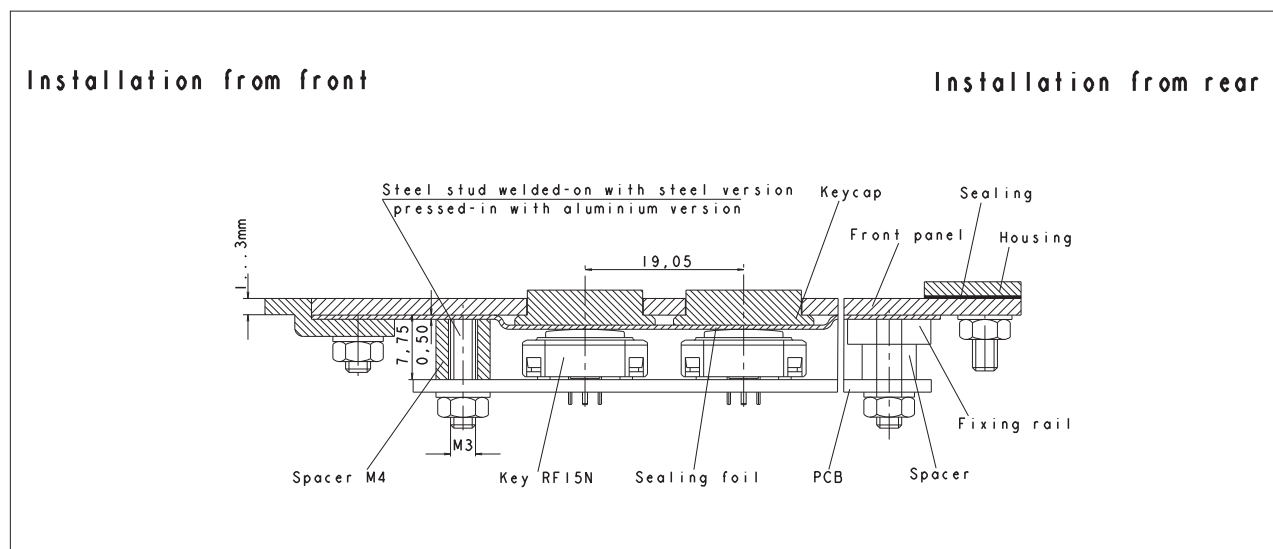

4

Mounting from front

Sealing foil between RK 90 keyboard and customer's front panel.

Mounting from rear

Sealing foil is screwed to RK 90 panel with fixing rails; sealing between keyboard and customer's front panel has to be provided.

Legending

- **Laser printing:** This labelling method is possible for opaque keycaps. The symbols are engraved in the keycaps with laser.
- When using transparent lenses, the pressure pad can be legended by printing.

As the legending is protected by the lens, it is friction-proof.

- **Engraving:** With this method the keycaps are engraved with the required symbol and then inlaid with ink.

RK
90

Recommendations

- **Front panel thickness:**
 - **Aluminum:** 2 mm (1.5 mm min, 3 mm max.)
(Fixing with M 3 pressed-in studs)
 - **Steel:** 2 mm (3 mm max.); V2A: 1.25 mm
(Fixing with M 3 welded-on studs)
The keytop surface is flush with the keyboard at a panel thickness of 3.5 mm.
- **Silicone sealing:**
 - Material: Silicone transparent
 - Type: A-SY 40-79
 - Hardness: 30° shore +/- 5°
 - Thickness: 0.45 +/- 0.05 mm
- **Installation:** Ensure that the keyboard slopes slightly so that any liquid can drain away between front panel and silicone sealing; if necessary, provide additional drain holes in the front panel.

Cleaning liquids

For the cleaning of the plastic keycaps please do not use cleaning liquids based on alcohol or acid.

RK 90 - Keycaps, plastic, 9 x 9 mm

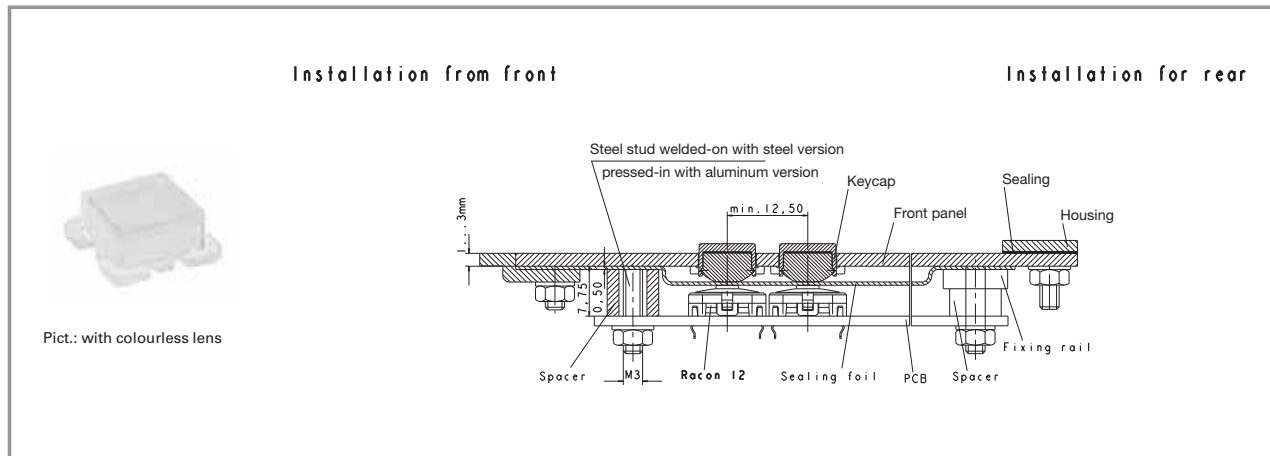

General Data

You can design especially small input fields with the small keycap 9 x 9 mm. For example, controls for measurement and laboratory equipment which do not offer much space for input fields because of their small size. RK 90 keycaps 9 x 9 mm and RACON short-travel keyswitches can be used to implement key grids of only 12.5 mm. The keycaps can be legended by laser-printing, engraving or standard printing. This keycap is our first choice in a combination with the illuminated RACON 12 i short-travel keyswitch.

Please note: For the cleaning of the plastic keycaps please do not use cleaning liquids based on alcohol or acid.

Technical Data

4	General information		Dimensions	
	Colour of lens	see order block	Dimension keycap in front of front panel	8.85 x 8.85 mm
	Size	1-module	Dimension keycap behind front panel	11.5 x 11.5 mm
	Degree of protection (with silicon seal)	IP65	Dimension (c) hole patterns final size	9.00 x 9.00 mm
	Illuminability	see order block	Dimension hole patterns punched size	9.20 x 9.20 mm

Please order lens separately.

RK 90 - Keycap body plastic, for lenses 9 x 9 mm

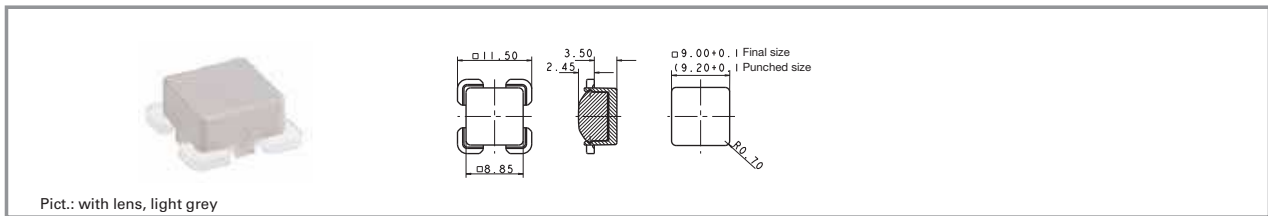

Pict.: with lens, light grey

Size	Illuminability	Dimension keycap behind front panel	Dimension keycap in front of front panel	Dimension (c) hole patterns final size	Order no. without lens	Note
1-module	yes	11.5 x 11.5 mm	8.85 x 8.85 mm	9.00 x 9.00 mm	5.55.103.265/1013	Please order lenses separately.

Technical data see page 4 - 92

Lenses:

- RK 90 - Lens, 9 x 9 mm, opaque red: 5.46.651.015/0309
- RK 90 - Lens, 9 x 9 mm, opaque yellow: 5.46.651.015/0409
- RK 90 - Lens, 9 x 9 mm, opaque green: 5.46.651.015/0514
- RK 90 - Lens, 9 x 9 mm, opaque blue: 5.46.651.015/0611
- RK 90 - Lens, 9 x 9 mm, opaque light grey: 5.46.651.015/0700
- RK 90 - Lens, 9 x 9 mm, transparent colourless: 5.46.651.019/1002
- RK 90 - Lens, 9 x 9 mm, transparent red: 5.46.651.019/1307
- RK 90 - Lens, 9 x 9 mm, transparent yellow: 5.46.651.019/1403
- RK 90 - Lens, 9 x 9 mm, transparent green: 5.46.651.019/1510

RK 90 - Keycaps, plastic, 14 mm

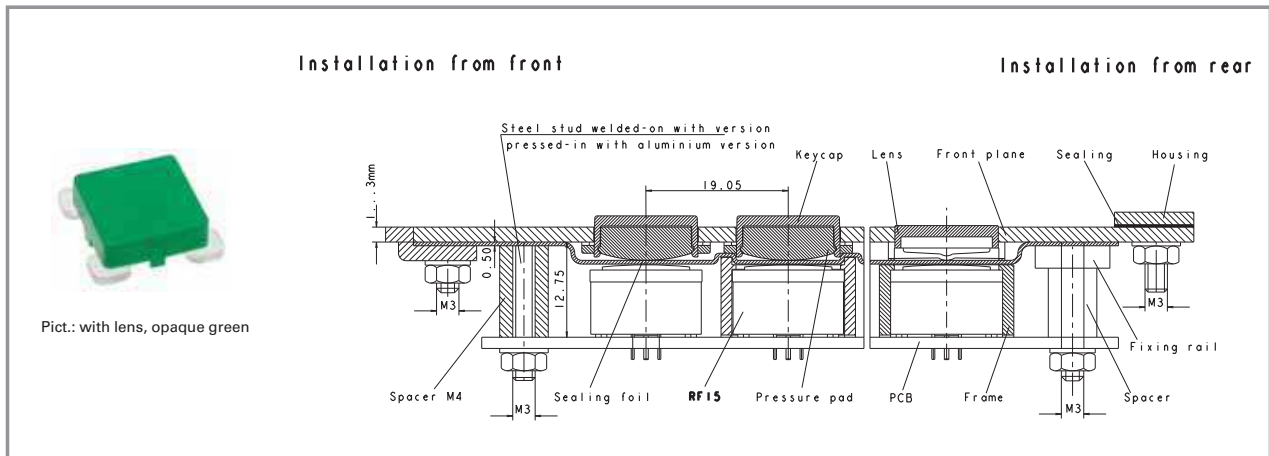

General Data

Keycap system for 19.05 mm grid. The keycaps can be legended by laser-printing, engraving or standard printing. Keycaps / sets with legends and other keycap shapes / colours available on request.

Please note: For the cleaning of the plastic keycaps please do not use cleaning liquids based on alcohol or acid.

Technical Data

4

General information

Colour of lens	see order block
Size	see order block
Degree of protection (with silicon seal)	IP65
Illuminability	yes

Dimensions

Dimension (b) in front of front panel	see order block
Dimension (a) behind front panel	see order block
Dimension (c) hole patterns final size	see order block
Dimension hole patterns punched size	see order block

RK 90

RK 90 - Keycap body plastic, for lenses 14 mm, 1-module

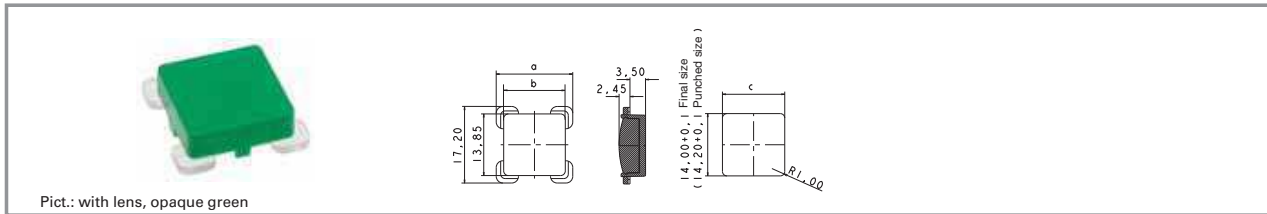

Pict.: with lens, opaque green

Size	Illuminability	Dimension (a) behind front panel	Dimension (b) in front of front panel	Dimension (c) hole patterns final size	Order no. without lens	Note
1-module	yes	17.20 x 17.20 mm	13.85 x 13.85 mm	14.00 x 14.00 mm	5.55.103.030/1013	Please order lenses separately.

Technical data see page 4 - 94

Lenses:

- RK 90 - Lens, 14 mm, 1-module, opaque red: 5.46.681.001/0309
- RK 90 - Lens, 14 mm, 1-module, opaque yellow: 5.46.681.001/0409
- RK 90 - Lens, 14 mm, 1-module, opaque green: 5.46.681.001/0514
- RK 90 - Lens, 14 mm, 1-module, opaque blue: 5.46.681.001/0611
- RK 90 - Lens, 14 mm, 1-module, opaque light grey: 5.46.681.001/0700
- RK 90 - Lens, 14 mm, 1-module, transparent colourless: 5.46.681.021/1002
- RK 90 - Lens, 14 mm, 1-module, transparent red: 5.46.681.021/1307
- RK 90 - Lens, 14 mm, 1.5-module, transparent yellow: 5.46.681.021/1403
- RK 90 - Lens, 14 mm, 1-module, transparent green: 5.46.681.021/1510

RK 90 - Keycap body plastic, for lenses 1¼-module

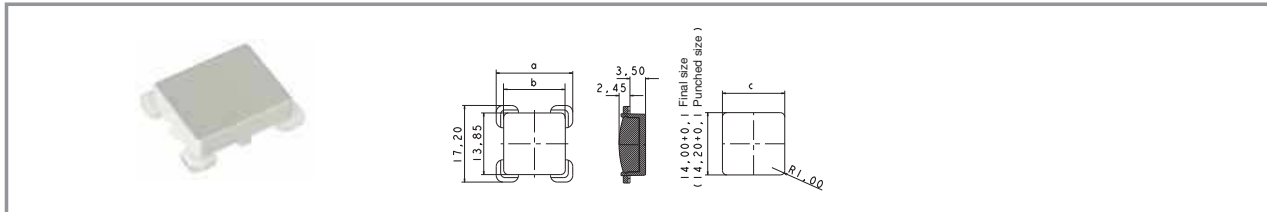

Size	Illuminability	Dimension (a) behind front panel	Dimension (b) in front of front panel	Dimension (c) hole patterns final size	Order no. without lens	Note
1 ¼-module	yes	17.20 x 20.7 mm	13.85 x 17.35 mm	14,00 x 17,5 mm	5.55.103.031/1013	Please order lenses separately.

Technical data see page 4 - 94

Lenses:

- RK 90 - Lens, 14 mm, 1.25-module, opaque red: 5.46.681.002/0309
- RK 90 - Lens, 14 mm, 1.25-module, opaque light grey: 5.46.681.002/0700
- RK 90 - Lens, 14 mm, 1.25-module, transparent colourless: 5.46.681.022/1002
- RK 90 - Lens, 14 mm, 1.25-module, transparent red: 5.46.681.022/1307
- RK 90 - Lens, 14 mm, 1.25-module, transparent yellow: 5.46.681.022/1403
- RK 90 - Lens, 14 mm, 1.25-module, transparent green: 5.46.681.022/1510

RK 90 - Keycap body plastic, for lenses 1 1/2-module

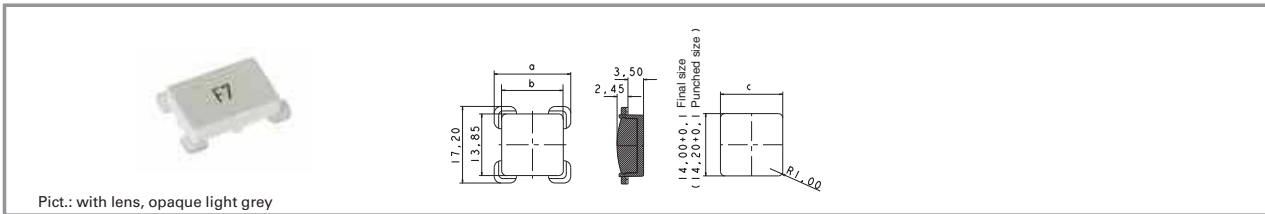

Pict.: with lens, opaque light grey

Size	Illuminability	Dimension (a) behind front panel	Dimension (b) in front of front panel	Dimension (c) hole patterns final size	Order no. without lens	Note
1 1/2-module	yes	17.20 x 24.20 mm	13.85 x 20.85 mm	14.00 x 21.00 mm	5.55.103.032/1013	Please order lenses separately.

Technical data see page 4 - 94

Lenses:

- RK 90 - Lens, 14 mm, 1.5-module, opaque red: 5.46.681.003/0309
- RK 90 - Lens, 14 mm, 1.5-module, opaque yellow: 5.46.681.003/0409
- RK 90 - Lens, 14 mm, 1.5-module, opaque green: 5.46.681.003/0514
- RK 90 - Lens, 14 mm, 1.5-module, opaque blue: 5.46.681.003/0611
- RK 90 - Lens, 14 mm, 1.5-module, opaque light grey: 5.46.681.003/0700
- RK 90 - Lens, 14 mm, 1.5-module, transparent colourless: 5.46.681.023/1002
- RK 90 - Lens, 14 mm, 1.5-module, transparent red: 5.46.681.023/1307
- RK 90 - Lens, 14 mm, 1.5-module, transparent yellow: 5.46.681.023/1403
- RK 90 - Lens, 14 mm, 1.5-module, transparent green: 5.46.681.023/1510

RK 90 - Keycap body plastic, for lenses 2-module

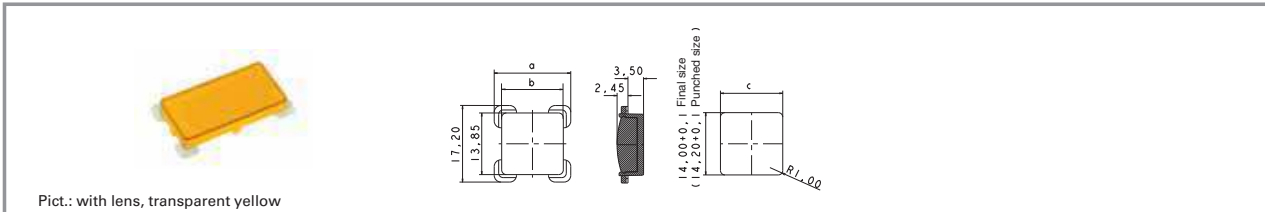

Pict.: with lens, transparent yellow

Size	Illuminability	Dimension (a) behind front panel	Dimension (b) in front of front panel	Dimension (c) hole patterns final size	Order no. without lens	Note
2-module	yes	17.20 x 31.20 mm	13.85 x 27.85 mm	14.00 x 28.00 mm	5.55.103.077/1013	Please order lenses separately.

Technical data see page 4 - 94

Lenses:

- RK 90 - Lens, 14 mm, 2-module, opaque red: 5.46.681.004/0309
- RK 90 - Lens, 14 mm, 2-module, opaque yellow: 5.46.681.004/0409
- RK 90 - Lens, 14 mm, 2-module, opaque green: 5.46.681.004/0514
- RK 90 - Lens, 14 mm, 2-module, opaque blue: 5.46.681.004/0611
- RK 90 - Lens, 14 mm, 2-module, opaque light grey: 5.46.681.004/0700
- RK 90 - Lens, 14 mm, 2-module, transparent colourless: 5.46.681.024/1002
- RK 90 - Lens, 14 mm, 2-module, transparent red: 5.46.681.024/1307
- RK 90 - Lens, 14 mm, 2-module, transparent yellow: 5.46.681.024/1403
- RK 90 - Lens, 14 mm, 2-module, transparent green: 5.46.681.024/1510

4

RK 90

RK 90 - Keycaps, aluminum, 14 x 14 mm

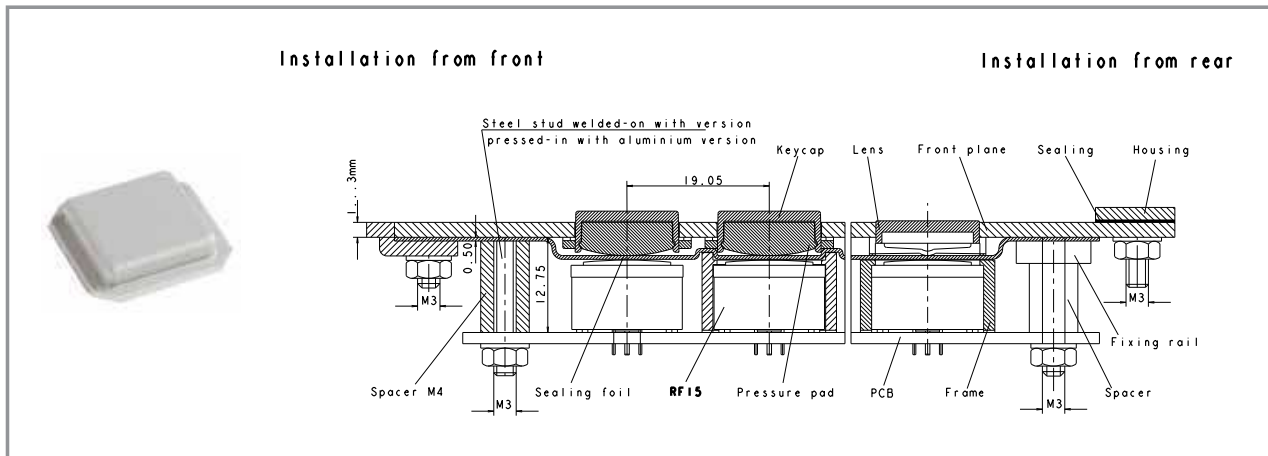

General Data

The RK 90 system design with metal keycaps is fairly safe against mechanical, thermal or chemical effects. Combined with a metal front panel, this data entry system offers maximum protection against vandalism. Tried and tested MICON 5, RACON 8/12 or RF 15/19 PCB keyswitches are used underneath the metal keycaps. The keycaps can be provided with engraved, coloured anodized or laser-printed legends. This means that the legend is durable and cannot be removed by mechanical or chemical means.

4

Technical Data

General information

Colour of lens	aluminum colourless anodized
Size	see order block
Degree of protection (with silicon seal)	IP65

Dimensions

Dimension (b) in front of front panel	see order block
Dimension (a) behind front panel	see order block
Dimension (c) hole patterns final size	see order block
Dimension hole patterns punched size	see order block

RK 90 - Keycaps, aluminum, 14 mm, 1-module

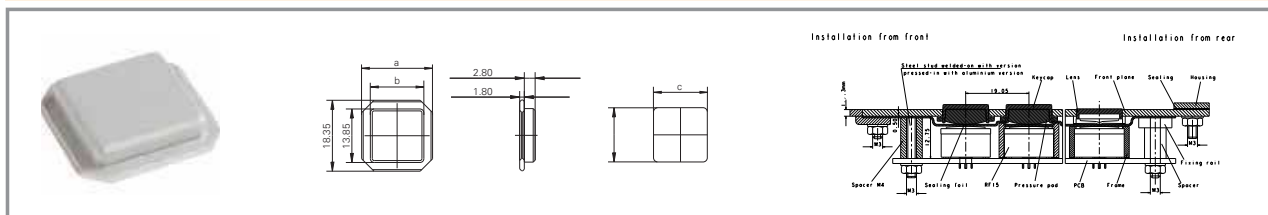

RK 90

Size	Colour of lens	Dimension (a) behind front panel	Dimension (b) in front of front panel	Dimension (c) hole patterns final size	Order no.
1-module	aluminum colourless anodized	18.35 x 18.35 mm	13.85 x 13.85 mm	14.00 x 14.00 mm	5.46.500.001/4010

RK 90 - Keycaps, aluminum, 14 mm, 1½-module

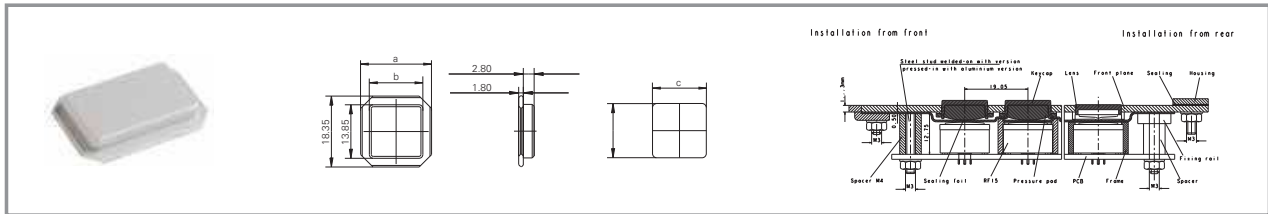

Size	Colour of lens	Dimension (a) behind front panel	Dimension (b) in front of front panel	Dimension (c) hole patterns final size	Order no.
1½-module	aluminum colourless anodized	18.35 x 25.35 mm	13.85 x 20.85 mm	14.00 x 21.00 mm	5.46.500.003/4010

Technical data see page 4 - 98

RK 90 - Keycaps, aluminum, 14 mm, 2-module

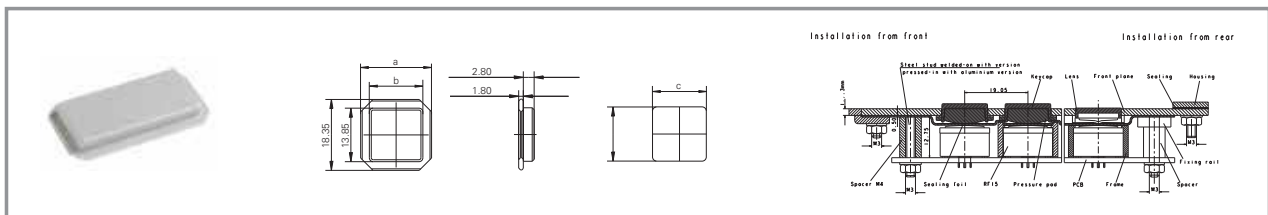

Size	Colour of lens	Dimension (a) behind front panel	Dimension (b) in front of front panel	Dimension (c) hole patterns final size	Order no.
2-module	aluminum colourless anodized	18.35 x 32.35 mm	13.85 x 27.85 mm	14.00 x 28.00 mm	5.46.500.004/4010

Technical data see page 4 - 98

RK 90 - Special accessories



Technical Data

General information

Colour

see order block

Dimensions

Dimensions

see order block

RK 90 - Fin, to avoid inadvertent operation

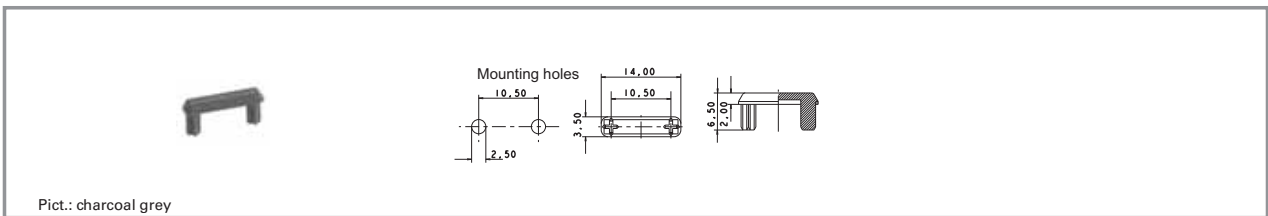

4

Short text	Feature 1	Feature 2	Order no.
RK 90 - Fin, to avoid inadvertent operation, light grey	-	-	5.55.103.079/0700
RK 90 - Fin, to avoid inadvertent operation, charcoal grey	-	-	5.55.103.079/0152

RK
90

RK 90 - Spacer M 4



Short text	Feature 1	Feature 2	Order no.
RK 90 - Spacer M 4 with RF 15 keys, height 12.50 mm, mounting from front (1 pc. per stud)	-	12.5 mm overall height for RF 15	5.30.764.040/0000
RK 90 - Spacer M 4 with RF 15 keys, height 9.25 mm, mounting from rear (1 pc. per stud)	-	9.25 mm overall height, for RF 15	5.30.764.027/0000
RK 90 - Spacer M 4 with RF 15 N keys, height 5.50 mm, mounting from rear (1 pc. per stud)	-	5.5 mm overall height, for RF15 N	5.30.764.010/0000
RK 90 - Spacer M 4 with RACON 8/12 keys, height 7.50 mm, mounting from front (1 pc. per stud)	-	7.5 mm overall height for RACON 8/12	5.30.764.018/0000
RK 90 - Spacer M 4 with RACON 8/12 keys, height 4.25 mm, mounting from rear (1 pc. per stud)	-	4.25 mm overall height, for RACON 8/12	5.30.764.005/0000

Technical data see page 4 - 100

RK 90 - Silicone foil 600 x 590 x 0.45 mm

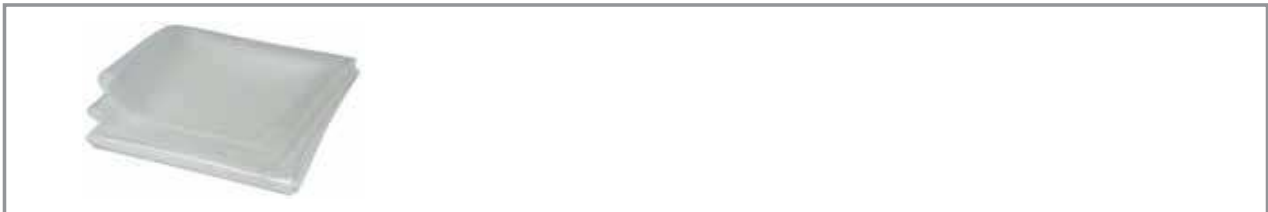

Short text	Feature 1	Feature 2	Order no.
RK 90 - Silicone foil 600 x 590 x 0.45 mm	transparent	600 x 590 x 0.45 mm	7.16.102.006/0000

Technical data see page 4 - 100



General Data

Vandal-proof input system, ideally suited for elevator controls, info terminals, vending machines, etc.

- Edge illumination and symbol illumination possible
- Connection: Each module individually with an 8-pin Micro-Match socket connector
- Modular fixing system with quick fasteners or single fixing
- Contact arrangement: 1 NO contact or 1 NC + 1 NO contact
- 50 V/250 mA max.
- Degree of protection IP65 (keylock switch IP40).

Content

RG 85 III - Keyswitch	4 - 106
RG 85 III - Keyswitch, round design, without lens	4 - 107
RG 85 III - Keyswitch, square design, without lens	4 - 108
RG 85 III - Keylock switch	4 - 110
RG 85 III - Keylock switch, round design, without lens	4 - 111
RG 85 III - Keylock switch, square design, without lens	4 - 112
RG 85 III - Signal indicator, without lens	4 - 114
RG 85 III - Signal indicator, without lens	4 - 115
RG 85 III - Accessories	4 - 116
RG 85 III - Lenses for keyswitches, round	4 - 116
RG 85 III - Lenses for keyswitches, square	4 - 118
RG 85 III - Lenses for keylock switches, round	4 - 121
RG 85 III - Lenses for keylock switches, square	4 - 121
RG 85 III - Lens, round, for signal indicators	4 - 121
RG 85 III - Lens, square, for signal indicators	4 - 122
RG 85 III - Lens, triangular, for signal indicators	4 - 122
Cable, 8 wires, with socket connectors on both ends	4 - 122
Fixing rail, length 490 mm	4 - 123
Spacer	4 - 123
Fixing piece for mounting the elements with the rail fixing method	4 - 123

System Features

Perfectly suited for: elevator controls, info terminals, vending machines, etc.

- Vandal proof construction
- Modular fixing system with quick fasteners or single fixing method using thread studs
- Connection with keyed 8-pin micro-match connector
- Degree of protection: IP40/65

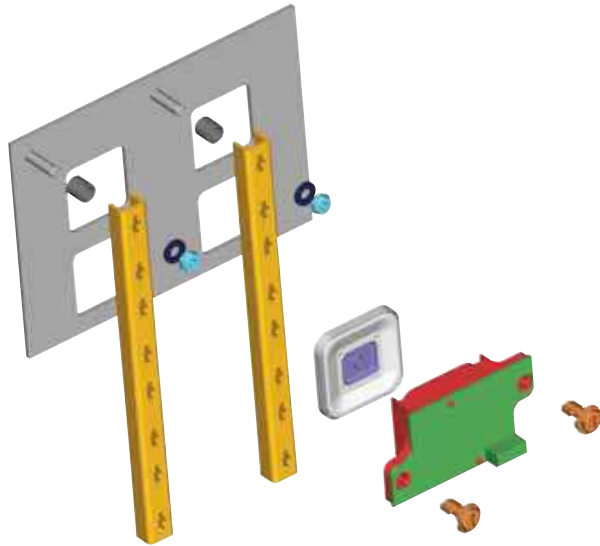

Keylock Switch Features

- Round or square design and lens shape
- Edge illumination in one or two colours with 4 LED for each colour
- Lens material: Aluminum or stainless steel with plastic inlays
- Contact arrangement: 1 NO
- Cylinder lock with pin tumblers
- Two switching positions: 0 and 90 degrees, key can be removed in any position
- Lock type 5201 – other lock types on request
- Included: 2 keys

Micro-Match Connector Pin Assignment

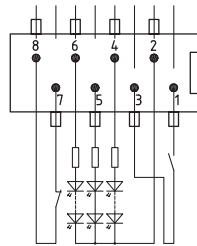

1/3 NO contact

2 OV – LED

4 Edge illuminat./signal indicator
1st colour + 24V DC +/- 20%

5 Symbol illumination
+ 24V DC +/- 20%

6 Edge illuminat./signal indicator
2nd colour + 24V DC +/- 20%

7/8 NC contact

4

Pushbutton Features

- Round or square design and lens shape
- Edge illumination in one or two colours with 4 LED for each colour
- Pushbutton with 1 NO contact: Additional illumination of the symbol with 2 LED possible
- Lens material: Aluminum or stainless steel with plastic inlays
- Switching element: short-travel keyswitch RF 19
 - 1 NO contact, non-illuminated
 - 1 NO contact, fully illuminated
 - 1 NC contact and 1 NO contact, non-illuminated

Signal Indicator Features

- Lens shape round, square or triangular (arrow shape)
- Lens material: Translucent plastic material
- Fully illuminated with 5 LED

Installation plan

Rail fixing method

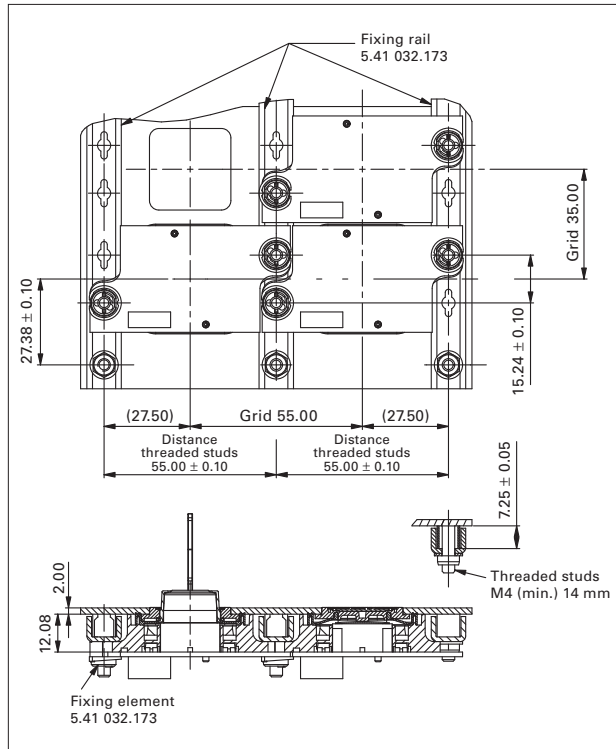

Single fixing method

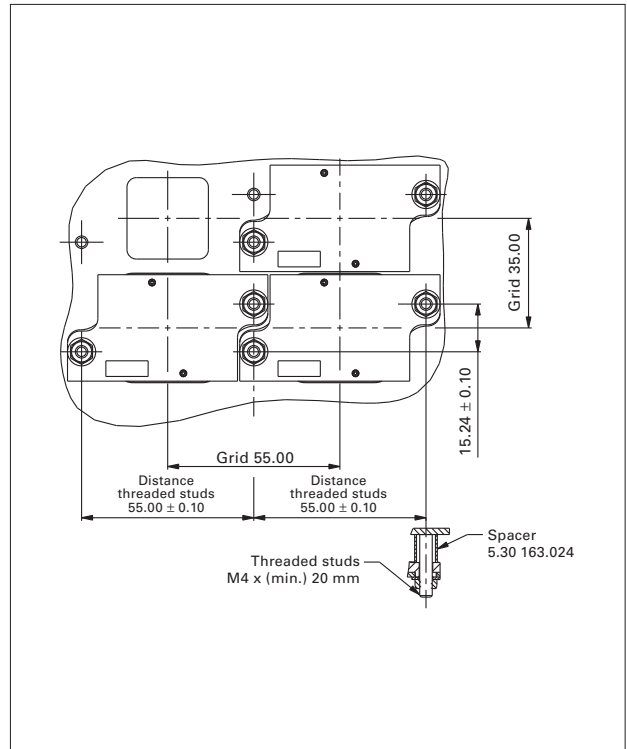

Front panel

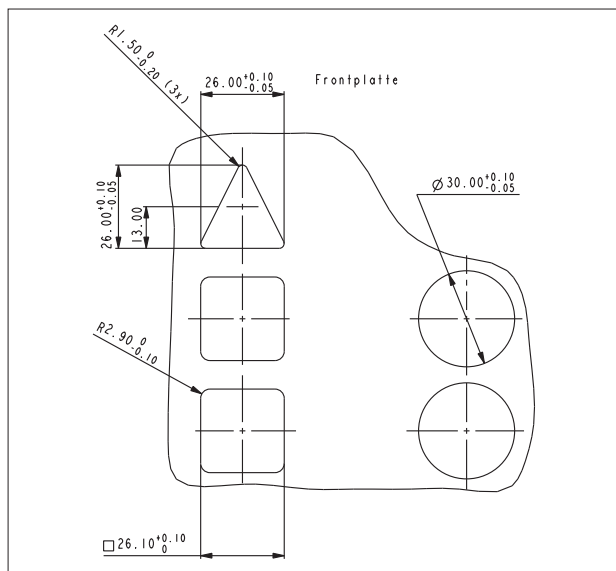

RG 85 III - Keyswitch



Technical Data

Dimensions

Mounting grid min.	55 x 35 mm
Length	64 mm
Width	34 mm

Mechanical design

Version	see order block
Mounting	on U-rails or single mounting
Terminals	8-pin Micro-Match® female connector
Contact system	snap-action (1 NO) or bridge contact (1 NC + 1 NO)
Contact arrangement	see order block
Contact materials	Ag
Symbol illumination	see order block
Edge illumination	see order block

Mechanical characteristics

Operating force	3.5 N
Operating travel	1 mm
Switching travel NO	1 mm
Switching travel NC	0.6 mm

Electrical characteristics

Rated voltage min.	3 V
Rated voltage max.	50 V
Rated current min.	0.1 mA
Rated current max.	250 mA
Rated power max.	12.5 W
Contact resistance when new max.	100 mΩ
Contact resistance acc. to life max.	3 Ω
Bouncing time max.	10 ms
Operating voltage for LED	24±20% V
Input current LED	per colour/LED row 9 - 16 mA

Other specifications

Ambient temp. operating min.	-25 °C
Ambient temp. operating max.	+70 °C
Storage temperature min.	-40 °C
Storage temperature max.	+80 °C
Environmental resistance	acc. to IEC 60068-2 -14, -30, -33 and -78
Operating life min. (operations)	1,000,000
Degree of protection rail mounting	IP40
Degree of protection single mounting	IP65
Flammability of materials	according to UL 94 HB

4

Typical accessories RG 85 III - Keyswitch

Description	Photo	Order no.	Additional accessories see page
Cable, 8 wires, with socket connectors on both ends, length 1 m		5.03.772.261/0000	4 - 122
RG 85 III - Lenses for keyswitches, round, stainless steel		5.04.914.000/2000	4 - 117
RG 85 III - Lenses for keyswitches, square, aluminum		5.04.915.100/2000	4 - 118

RG 85 III

RG 85 III - Keyswitch, round design, without lens

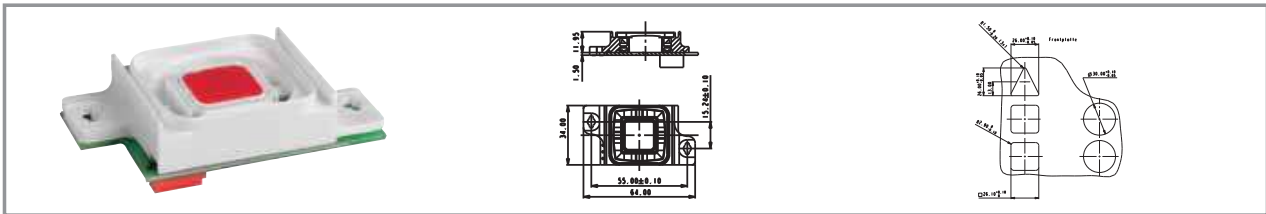

Contact arrangement	Edge illumination	Symbol illumination	Version	Order no.
1 NO	4 LED white	-	round	3.99.400.111/2000
1 NO	4 LED red	-	round	3.99.400.111/3000
1 NO	4 LED yellow	-	round	3.99.400.111/4000
1 NO	4 LED green	-	round	3.99.400.111/5000
1 NO	4 LED blue	-	round	3.99.400.111/6000
1 NO	4 LED white, 4 LED blue	-	round	3.99.400.111/7000
1 NO	4 LED green, 4 LED red	-	round	3.99.400.111/8000
1 NO	4 LED white	2 LED yellow	round	3.99.400.111/2400
1 NO	4 LED red	2 LED red	round	3.99.400.111/3300
1 NO	4 LED yellow	2 LED green	round	3.99.400.111/4500
1 NO	4 LED green	2 LED green	round	3.99.400.111/5500
1 NO	4 LED blue	2 LED blue	round	3.99.400.111/6600
1 NO	4 LED white, 4 LED blue	2 LED blue	round	3.99.400.111/7600
1 NO	4 LED green, 4 LED red	2 LED red	round	3.99.400.111/8300
1 NC + 1 NO	4 LED white	-	round	3.99.400.131/2000
1 NC + 1 NO	4 LED red	-	round	3.99.400.131/3000
1 NC + 1 NO	4 LED yellow	-	round	3.99.400.131/4000
1 NC + 1 NO	4 LED green	-	round	3.99.400.131/5000
1 NC + 1 NO	4 LED blue	-	round	3.99.400.131/6000
1 NC + 1 NO	4 LED white, 4 LED blue	-	round	3.99.400.131/7000
1 NC + 1 NO	4 LED green, 4 LED red	-	round	3.99.400.131/8000

4

Technical data see page 4 - 106

Please order lenses (round shape) separately.

RG
85 III

RG 85 III - Keyswitch, square design, without lens

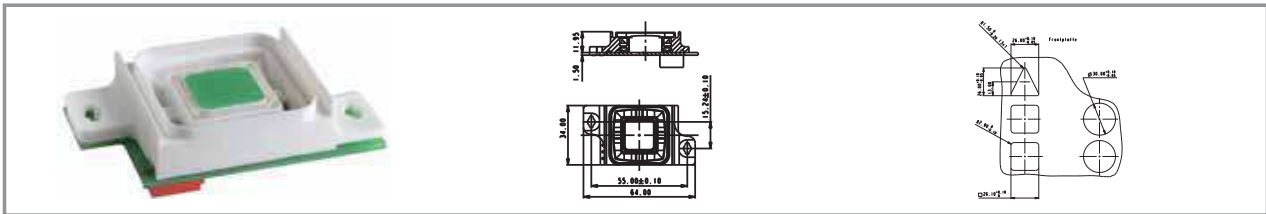

Contact arrangement	Edge illumination	Symbol illumination	Version	Order no.
1 NO	4 LED white	-	square	3.99.400.112/2000
1 NO	4 LED red	-	square	3.99.400.112/3000
1 NO	4 LED yellow	-	square	3.99.400.112/4000
1 NO	4 LED green	-	square	3.99.400.112/5000
1 NO	4 LED blue	-	square	3.99.400.112/6000
1 NO	4 LED white, 4 LED blue	-	square	3.99.400.112/7000
1 NO	4 LED green, 4 LED red	-	square	3.99.400.112/8000
1 NO	4 LED white	2 LED yellow	square	3.99.400.112/2400
1 NO	4 LED red	2 LED red	square	3.99.400.112/3300
1 NO	4 LED yellow	2 LED green	square	3.99.400.112/4500
1 NO	4 LED green	2 LED green	square	3.99.400.112/5500
1 NO	4 LED blue	2 LED blue	square	3.99.400.112/6600
1 NO	4 LED white, 4 LED blue	2 LED blue	square	3.99.400.112/7600
1 NO	4 LED green, 4 LED red	2 LED red	square	3.99.400.112/8300
1 NC + 1 NO	4 LED white	-	square	3.99.400.132/2000
1 NC + 1 NO	4 LED red	-	square	3.99.400.132/3000
1 NC + 1 NO	4 LED yellow	-	square	3.99.400.132/4000
1 NC + 1 NO	4 LED green	-	square	3.99.400.132/5000
1 NC + 1 NO	4 LED blue	-	square	3.99.400.132/6000
1 NC + 1 NO	4 LED white, 4 LED blue	-	square	3.99.400.132/7000
1 NC + 1 NO	4 LED green, 4 LED red	-	square	3.99.400.132/8000

4

RG 85 III

Technical data see page 4 - 106

Please order lenses (square shape) separately.

RG 85 III - Keylock switch



Technical Data

Dimensions

Mounting grid min.	55 x 35 mm
Length	64 mm
Width	34 mm (35 mm with sealing)
Mounting depth	see order block

Mechanical design

Version	see order block
Mounting	on U-rails or single mounting
Terminals	8-pin Micro-Match® female connector
Contact system	cross contact
Contact arrangement	1 NO
Contact materials	Au alloy
Symbol illumination	none
Edge illumination	see order block
Lock	cylinder lock, lock type 5201
Key removal position	Pos. 0 + 1

Mechanical characteristics

Rotating angle	1 x 90°
Switching travel NO	1 mm
Switching travel NC	see order block

Electrical characteristics

Rated voltage min.	3 V
Rated voltage max.	35 V
Rated current min.	0.1 mA
Rated current max.	100 mA
Rated power max.	1 W
Contact resistance when new max.	100 mΩ
Contact resistance acc. to life max.	3 Ω
Bouncing time max.	10 ms
Operating voltage for LED	24±20% V
Input current LED	per colour/LED row 9 - 16 mA

Other specifications

Ambient temp. operating min.	-25 °C
Ambient temp. operating max.	+70 °C
Storage temperature min.	-40 °C
Storage temperature max.	+80 °C
Environmental resistance	acc. to IEC 60068-2 -14, -30, -33 and -78
Operating life min. (operations)	50,000
Degree of protection rail mounting	IP40
Degree of protection single mounting	IP65
Flammability of materials	according to UL 94 HB

4

Typical accessories RG 85 III - Keylock switch

Description	Photo	Order no.	Additional accessories see page
RG 85 III - Lenses for keylock switches, round, stainless steel		5.04.914.200/2000	4 - 121
RG 85 III - Lenses for keylock switches, square, aluminum		5.04.915.201/2000	4 - 121

RG 85 III

RG 85 III - Keylock switch, square design, without lens



Contact arrangement	Edge illumination	Rotating angle	Version	Order no.
1 NO	4 LED white	1 x 90°	square	3.99.400.142/2000
1 NO	4 LED red	1 x 90°	square	3.99.400.142/3000
1 NO	4 LED yellow	1 x 90°	square	3.99.400.142/4000
1 NO	4 LED green	1 x 90°	square	3.99.400.142/5000
1 NO	4 LED blue	1 x 90°	square	3.99.400.142/6000
1 NO	4 LED white, 4 LED blue	1 x 90°	square	3.99.400.142/7000
1 NO	4 LED green, 4 LED red	1 x 90°	square	3.99.400.142/8000

Technical data see page 4 - 110

Accessoires:

RG 85 III - Lenses for keylock switches, square, stainless steel: 5.04.914.201/2000

Please order lenses (square shape) separately.

4

RG
85 III

RG 85 III - Signal indicator, without lens



Technical Data

Dimensions

Mounting grid min.	55 x 35 mm
Length	64 mm
Width	34 mm

Mechanical design

Version	according to lens
Mounting	on U-rails or single mounting
Terminals	8-pin Micro-Match® female connector
Illumination	see order block

Other specifications

Ambient temp. operating min.	-25 °C
Ambient temp. operating max.	+70 °C
Storage temperature min.	-40 °C
Storage temperature max.	+80 °C
Environmental resistance	acc. to IEC 60068-2 -14, -30, -33 and -78
Degree of protection rail mounting	IP40
Degree of protection single mounting	IP65
Flammability of materials	according to UL 94 HB

Electrical characteristics

Operating voltage for LED	24±20% V
Input current LED	depending on LED colour 20 - 30 mA

4

Typical accessories RG 85 III - Signal indicator, without lens

Description	Photo	Order no.	Additional accessories see page
Cable, 8 wires, with socket connectors on both ends, length 2 m		5.03.772.262/0000	4 - 122
RG 85 III - Lens, square, for signal indicators		5.04.903.009/0000	4 - 122
RG 85 III - Lens, round, for signal indicators		5.04.903.010/0000	4 - 121
RG 85 III - Lens, triangular, for signal indicators		5.04.903.011/0000	4 - 122

RG 85 III

RG 85 III - Signal indicator, without lens



Illumination	Order no.
5 LED white	3.99.400.100/2000
5 LED red	3.99.400.100/3000
5 LED yellow	3.99.400.100/4000
5 LED green	3.99.400.100/5000
5 LED blue	3.99.400.100/6000
5 LED white, 5 LED blue	3.99.400.100/7000
5 LED green, 5 LED red	3.99.400.100/8000

Technical data see page 4 - 114

Please order round, square or triangular lenses separately.

RG 85 III - Accessories



RG 85 III - Lenses for keyswitches, round



Version	Form of lens	Legending colour	Legending	Order no.
aluminum	round	-	-	5.04.915.000/2000
aluminum	round	opaque black	1	5.04.915.001/0100
aluminum	round	translucent white	1	5.04.915.001/2000
aluminum	round	opaque black	2	5.04.915.002/0100
aluminum	round	translucent white	2	5.04.915.002/2000
aluminum	round	opaque black	3	5.04.915.003/0100
aluminum	round	translucent white	3	5.04.915.003/2000
aluminum	round	opaque black	4	5.04.915.004/0100
aluminum	round	translucent white	4	5.04.915.004/2000
aluminum	round	opaque black	5	5.04.915.005/0100
aluminum	round	translucent white	5	5.04.915.005/2000
aluminum	round	opaque black	6	5.04.915.006/0100
aluminum	round	translucent white	6	5.04.915.006/2000
aluminum	round	opaque black	U	5.04.915.021/0100
aluminum	round	translucent white	U	5.04.915.021/2000

4

RG
85 III

Version	Form of lens	Legending colour	Legending	Order no.
aluminum	round	opaque black	K	5.04.915.022/0100
aluminum	round	translucent white	K	5.04.915.022/2000
aluminum	round	opaque black	E	5.04.915.023/0100
aluminum	round	translucent white	E	5.04.915.023/2000
aluminum	round	opaque yellow	symbol „bell“	5.04.915.024/0400
aluminum	round	opaque black	symbol „open door“	5.04.915.025/0100
aluminum	round	translucent white	symbol „open door“	5.04.915.025/2000
aluminum	round	opaque black	symbol „close door“	5.04.915.026/0100
aluminum	round	translucent white	symbol „close door“	5.04.915.026/2000
aluminum	round	opaque black	symbol „ventilator“	5.04.915.027/0100
aluminum	round	translucent white	symbol „ventilator“	5.04.915.027/2000
aluminum	round	opaque black	symbol „arrow“	5.04.915.028/0100
aluminum	round	translucent white	symbol „arrow“	5.04.915.028/2000
stainless steel	round	-	-	5.04.914.000/2000
stainless steel	round	opaque black	1	5.04.914.001/0100
stainless steel	round	translucent white	1	5.04.914.001/2000
stainless steel	round	opaque black	2	5.04.914.002/0100
stainless steel	round	translucent white	2	5.04.914.002/2000
stainless steel	round	opaque black	3	5.04.914.003/0100
stainless steel	round	translucent white	3	5.04.914.003/2000
stainless steel	round	opaque black	4	5.04.914.004/0100
stainless steel	round	translucent white	4	5.04.914.004/2000
stainless steel	round	opaque black	5	5.04.914.005/0100
stainless steel	round	translucent white	5	5.04.914.005/2000
stainless steel	round	opaque black	6	5.04.914.006/0100
stainless steel	round	translucent white	6	5.04.914.006/2000
stainless steel	round	opaque black	U	5.04.914.021/0100
stainless steel	round	translucent white	U	5.04.914.021/2000



Version	Form of lens	Legending colour	Legending	Order no.
stainless steel	round	opaque black	K	5.04.914.022/0100
stainless steel	round	translucent white	K	5.04.914.022/2000
stainless steel	round	opaque black	E	5.04.914.023/0100
stainless steel	round	translucent white	E	5.04.914.023/2000
stainless steel	round	opaque yellow	symbol „bell“	5.04.914.024/0400
stainless steel	round	opaque black	symbol „open door“	5.04.914.025/0100
stainless steel	round	translucent white	symbol „open door“	5.04.914.025/2000
stainless steel	round	opaque black	symbol „close door“	5.04.914.026/0100
stainless steel	round	translucent white	symbol „close door“	5.04.914.026/2000
stainless steel	round	opaque black	symbol „ventilator“	5.04.914.027/0100
stainless steel	round	translucent white	symbol „ventilator“	5.04.914.027/2000
stainless steel	round	opaque black	symbol „arrow“	5.04.914.028/0100
stainless steel	round	translucent white	symbol „arrow“	5.04.914.028/2000

Technical data see page 4 - 114

The lenses without legending can not be engraved - other than the mentioned legends on request.

4

RG 85 III - Lenses for keyswitches, square



Version	Form of lens	Legending colour	Legending	Order no.
aluminum	square	-	-	5.04.915.100/2000
aluminum	square	opaque black	1	5.04.915.101/0100
aluminum	square	translucent white	1	5.04.915.101/2000
aluminum	square	opaque black	2	5.04.915.102/0100
aluminum	square	translucent white	2	5.04.915.102/2000
aluminum	square	opaque black	3	5.04.915.103/0100

RG
85 III

Version	Form of lens	Legending colour	Legending	Order no.
aluminum	square	translucent white	3	5.04.915.103/2000
aluminum	square	opaque black	4	5.04.915.104/0100
aluminum	square	translucent white	4	5.04.915.104/2000
aluminum	square	opaque black	5	5.04.915.105/0100
aluminum	square	translucent white	5	5.04.915.105/2000
aluminum	square	opaque black	6	5.04.915.106/0100
aluminum	square	translucent white	6	5.04.915.106/2000
aluminum	square	opaque black	U	5.04.915.121/0100
aluminum	square	translucent white	U	5.04.915.121/2000
aluminum	square	opaque black	K	5.04.915.122/0100
aluminum	square	translucent white	K	5.04.915.122/2000
aluminum	square	opaque black	E	5.04.915.123/0100
aluminum	square	translucent white	E	5.04.915.123/2000
aluminum	square	opaque yellow	symbol „bell“	5.04.915.124/0400
aluminum	square	opaque black	symbol „open door“	5.04.915.125/0100
aluminum	square	translucent white	symbol „open door“	5.04.915.125/2000
aluminum	square	opaque black	symbol „close door“	5.04.915.126/0100
aluminum	square	translucent white	symbol „close door“	5.04.915.126/2000
aluminum	square	opaque black	symbol „ventilator“	5.04.915.127/0100
aluminum	square	translucent white	symbol „ventilator“	5.04.915.127/2000
aluminum	square	opaque black	symbol „arrow“	5.04.915.128/0100
aluminum	square	translucent white	symbol „arrow“	5.04.915.128/2000
stainless steel	square	-	-	5.04.914.100/2000
stainless steel	square	opaque black	1	5.04.914.101/0100
stainless steel	square	translucent white	1	5.04.914.101/2000
stainless steel	square	opaque black	2	5.04.914.102/0100
stainless steel	square	translucent white	2	5.04.914.102/2000
stainless steel	square	opaque black	3	5.04.914.103/0100

4

RG
85 III

Version	Form of lens	Legending colour	Legending	Order no.
stainless steel	square	translucent white	3	5.04.914.103/2000
stainless steel	square	opaque black	4	5.04.914.104/0100
stainless steel	square	translucent white	4	5.04.914.104/2000
stainless steel	square	opaque black	5	5.04.914.105/0100
stainless steel	square	translucent white	5	5.04.914.105/2000
stainless steel	square	opaque black	6	5.04.914.106/0100
stainless steel	square	translucent white	6	5.04.914.106/2000
stainless steel	square	opaque black	U	5.04.914.121/0100
stainless steel	square	translucent white	U	5.04.914.121/2000
stainless steel	square	opaque black	K	5.04.914.122/0100
stainless steel	square	translucent white	K	5.04.914.122/2000
stainless steel	square	opaque black	E	5.04.914.123/0100
stainless steel	square	translucent white	E	5.04.914.123/2000
stainless steel	square	opaque yellow	symbol „bell“	5.04.914.124/0400
stainless steel	square	opaque black	symbol „open door“	5.04.914.125/0100
stainless steel	square	translucent white	symbol „open door“	5.04.914.125/2000
stainless steel	square	opaque black	symbol „close door“	5.04.914.126/0100
stainless steel	square	translucent white	symbol „close door“	5.04.914.126/2000
stainless steel	square	opaque black	symbol „ventilator“	5.04.914.127/0100
stainless steel	square	translucent white	symbol „ventilator“	5.04.914.127/2000
stainless steel	square	opaque black	symbol „arrow“	5.04.914.128/0100
stainless steel	square	translucent white	symbol „arrow“	5.04.914.128/2000

The lenses without legending can not be engraved - other than the mentioned legends on request.

4

RG
85 III

RG 85 III - Lenses for keylock switches, round



Version	Form of lens	Legending colour	Legending	Order no.
aluminum	round	-	-	5.04.915.200/2000
stainless steel	round	-	-	5.04.914.200/2000

RG 85 III - Lenses for keylock switches, square



Version	Form of lens	Legending colour	Legending	Order no.
aluminum	square	-	-	5.04.915.201/2000
stainless steel	square	-	-	5.04.914.201/2000

4

RG 85 III - Lens, round, for signal indicators

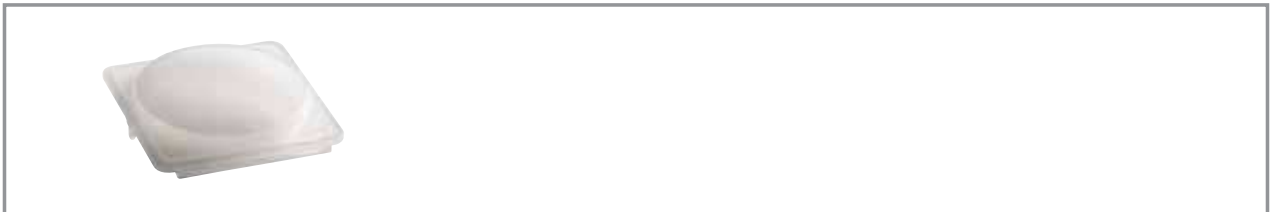

Version	Form of lens	Legending colour	Legending	Order no.
plastic translucent	round	-	-	5.04.903.010/0000

RG
85 III

RG 85 III - Lens, square, for signal indicators



Version	Form of lens	Legending colour	Legending	Order no.
plastic translucent	square	-	-	5.04.903.009/0000

RG 85 III - Lens, triangular, for signal indicators



Version	Form of lens	Legending colour	Legending	Order no.
plastic translucent	triangular	-	-	5.04.903.011/0000

4

Cable, 8 wires, with socket connectors on both ends



Version	Form of lens	Legending colour	Legending	Order no.
length: 1 m	-	-	-	5.03.772.261/0000
length: 2 m	-	-	-	5.03.772.262/0000

RG
85 III

Fixing rail, length 490 mm



Version	Form of lens	Legending colour	Legending	Order no.
length: 490 mm	-	-	-	5.41.032.173/7500

Spacer



Version	Form of lens	Legending colour	Legending	Order no.
mounting on rails	-	-	-	5.30.163.021/6000
single mounting	-	-	-	5.30.163.024/6000

4

Fixing piece for mounting the elements with the rail fixing method

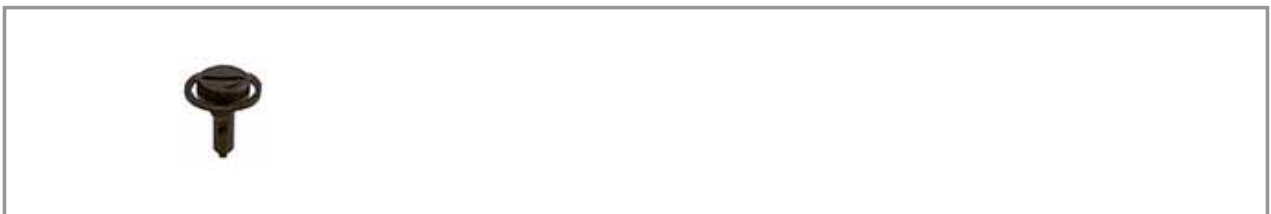

Version	Form of lens	Legending colour	Legending	Order no.
-	-	-	-	5.55.104.208/0459

**RG
85 III**



General Data

The RS 76 full-travel keyswitches are designed for configuring keyboards. They offer very comfortable operation with an overall height of 15.5 / 15.9 mm and a key travel of 4 mm. The modular system with a grid of 3/4" = 19.05 mm enables you to design any key block you may want.

Mechanical contact system RS 76 M

A gold alloy is used as the contact material and provides high contact reliability, low contact resistance and short bouncing time.

Solid-state contact system RS 76 C

The solid-state switch in Hall-IC technology ensures bounce-free and wear-free switching and a long operating life.

Function: When pressing the keys, a permanent magnet changes its position relative to the Hall-IC and thereby generates an output signal. Their use is especially recommended in hostile environments and for heavy duty applications.

Content

RS 76 M - Full-travel keyswitch, not illuminable	4 - 132
RS 76 M - Full-travel keyswitch, not illuminable	4 - 133
RS 76 M - Full-travel keyswitch, with diode, not illuminable	4 - 133
RS 76 M - Full-travel keyswitch, illuminable	4 - 134
RS 76 M - Full-travel keyswitch, illuminable, momentary	4 - 135
RS 76 M - Full-travel keyswitch, illuminable, latching	4 - 135
RS 76 MX - Full-travel keyswitch, fully illuminable	4 - 136
RS 76 C - Full-travel keyswitch, not illuminable	4 - 138
RS 76 C - Full-travel keyswitch, not illuminable	4 - 139
RS 76 C - Full-travel keyswitch, illuminable	4 - 140
RS 76 C - Full-travel keyswitch, illuminable, momentary	4 - 141
RS 76 C - Full-travel keyswitch, illuminable, latching	4 - 141
RS 76 - Keycaps, not illuminable	4 - 142
RS 76 - Keycap, opaque	4 - 142
RS 76 - Keycap, opaque, with nail protection	4 - 142
RS 76 - Keycap with legend insert	4 - 143
RS 76 - Keycaps, illuminable	4 - 144
RS 76 - Keycap with light bar	4 - 144
RS 76 - Keycap, illuminable, with legend insert	4 - 144
RS 76 - Keycap, illuminable, with nail protection and legend insert	4 - 145
RS 76 - Keycap, illuminable, with legend insert	4 - 145
RS 76 MX - Keycap, fully illuminable	4 - 146
RS 76 - Keycaps, with legend, two-shot moulded/keycap sets	4 - 148
RS 76 - Keycap set, symbols A-Z	4 - 148
RS 76 - Keycap set, symbols 0-9	4 - 149
RS 76 - Accessories	4 - 150
RS 76 - Cover IP40	4 - 151
 PCB Keyswitches	 4 - 125

The RAFI full-travel keyswitches RS 76 are modular systems for designing individual key blocks and keyboards in the 3/4 inch (= 19.05 mm) grid.

Definitions

Momentary keyswitches

Momentary keyswitches return to their initial position after being pressed (momentary action).

Latching keyswitches

Latching keyswitches lock when actuated and are returned to their initial position when pressed again (push-push action).

Keycap materials

Keycap without legend insert: ABS
Keycap with legend insert:
– Keycap body: ABS
– Lens: PC

Keycap, n-module

A 2-module keycap f. ex. has the twofold length of a 1-module keycap.

Contact principle

There are two contact principles:

- **Mechanical (M):** Cross contact (RS 76 M)
Bridge contact
(RS 76 M, illuminated)
- **Contactless (C):** Based on Hall-IC (RS 76 C)

Manual Soldering

The soldering temperature should not exceed 300 °C and the soldering time should be less than 5 seconds.

Legending of keycaps

Keycaps can be legended by different methods:

Two-shot moulding

Using this method the symbol is separately manufactured from a plastic and then the appropriate keycap form is moulded round it. Advantage: The character becomes an integrated part of the keycap, thus eliminating abrasion. All RAFI keycap sets with standard legending are manufactured by this method.
Customer specific two-shot moulded keycaps on request.

Printing

Keycaps can be printed with a two-component ink on request. The abrasion of this kind of legending is high. This method of legending is suitable for average volumes.

Engraving

In this labour intensive process the keycaps are engraved with the required symbol, then inlaid with ink. Only used for small volumes.

Laser-printing

This method of legending can be recommended when complete keyboards are required in different keyboard layouts for which RAFI will develop the respective software. The keyboards can then be legended within a short time. This method of legending is particularly recommended for average to large volumes.

Legend inserts

In the case of keycaps with replaceable legend inserts it is possible to print or engrave the legend inserts. As these inserts are protected by the lens, there can be no abrasion here either.

4

Design

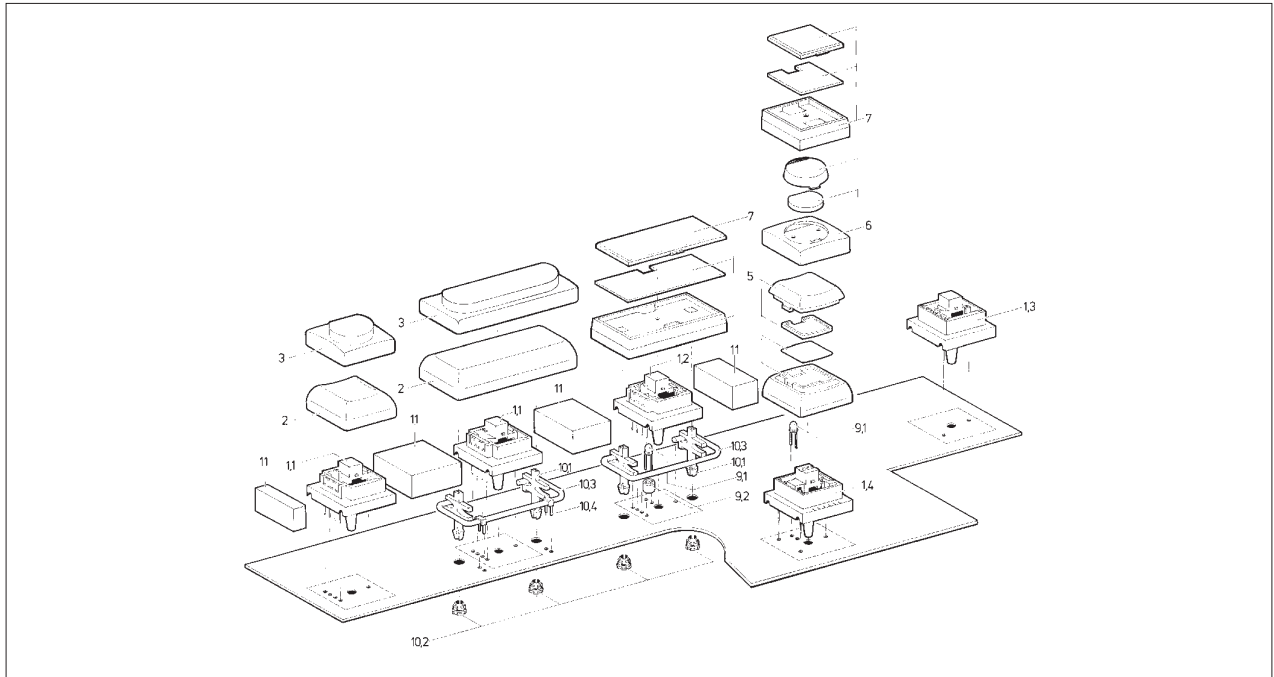

No. Description

- 1.1 Keyswitch RS 76 C
- 1.2 Keyswitch RS 76 C with LED
- 1.3 Keyswitch RS 76 M
- 1.4 Keyswitch R 76 M with LED
- 2 Keycap, 1- resp. multi-module
- 3 Keycap with nail protection, 1- resp. multi-module
- 5 Keycap, illuminated
- 6 Keycap, illuminated
- 7 Keycap, illuminated
- 9.1 LED

- 9.2 Spacer for LED (for RS 76 C only)
- 10.1 Plunger for multi-moduel keycaps*
- 10.2 Sleeve for multi-moduel keycaps*
- 10.3 Metal lever for multi-module keycaps*
- 10.4 Bearing bracket for multi-module keycaps*
- 11 Covers

*These parts are included as a complete packet in the delivery of keycaps \geq 2-module.

Hole Pattern PCB RS 76 M/RS 76 C

The hole patterns apply to the horizontal position of the keycaps only. Should they be in a vertical position,

the momentary keyswitch must be mounted accordingly, i. e. rotated by 90°.

For 1 – 1¾-module keycaps (view on component side)

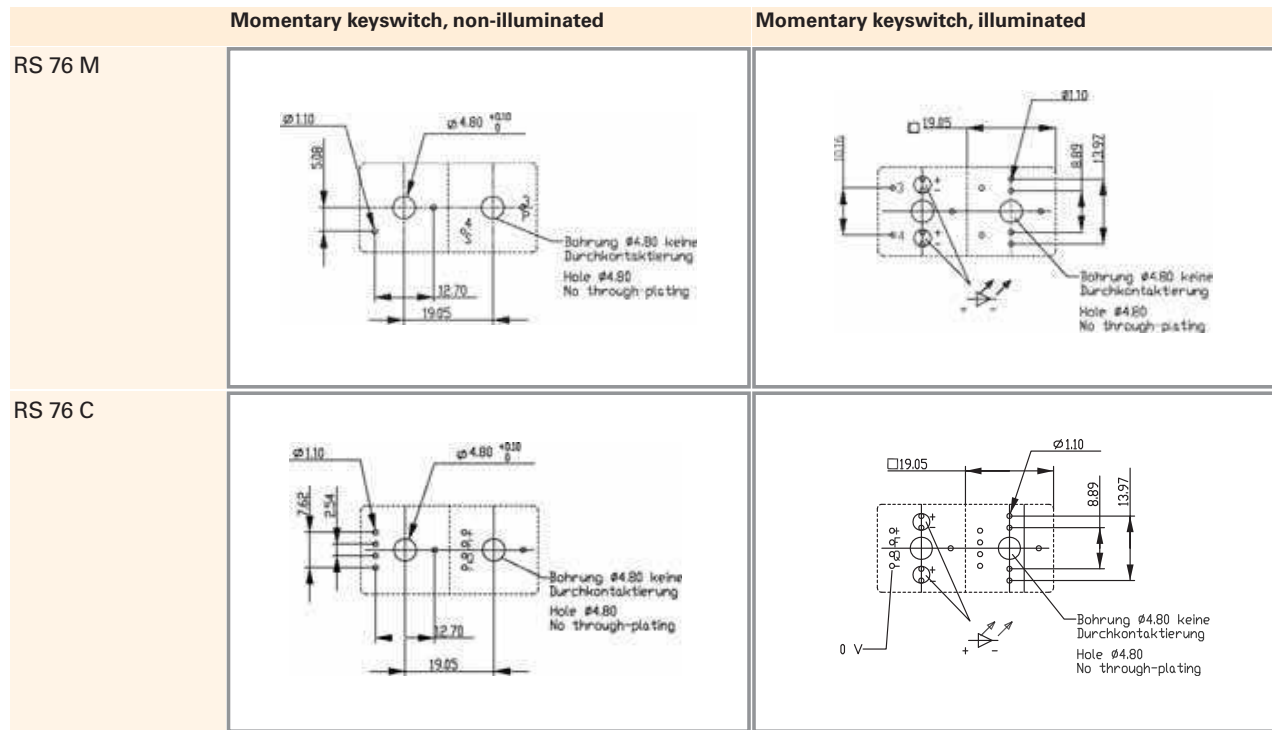

4

For 2-, 3- and 8-module keycaps (view on component side)

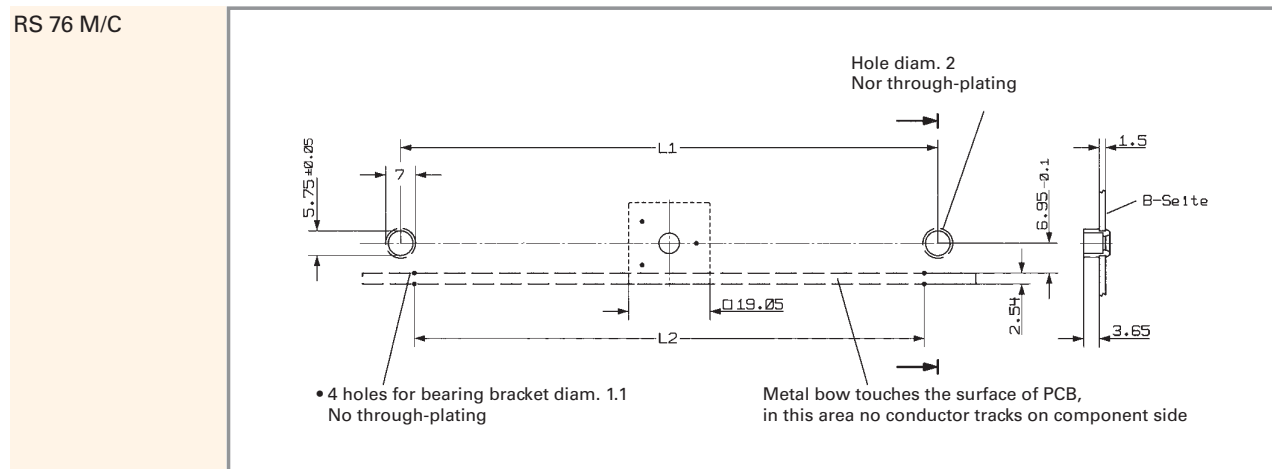

Keycap	L 1 mm	L 2 mm
2-module	25,40	22,86
3-module	30,48	24,13
5-module	68,58	68,58

Important note: In the case of 2-, 3- and 8-module keycaps, additional holes must be provided for the accessories. In the case of keycaps < 2-module, neither accessories nor holes are required.

Specific Technical Data RS 76 C

Output pulse diagram Dynamic characteristics (max.)		$T_w = 25\text{ }^\circ\text{C}$	$T_w = 50\text{ }^\circ\text{C}$	$T_w = 70\text{ }^\circ\text{C}$
Turn-on delay time	t_{PHL}	3 μs	7 μs	10 μs
Turn-off delay time	t_{PHL}	4 μs	5 μs	6 μs
Fall/rise time	t_{PHL}	2 μs	2,5 μs	3 μs
	t_{PHL}	1 μs	1,5 μs	2,5 μs

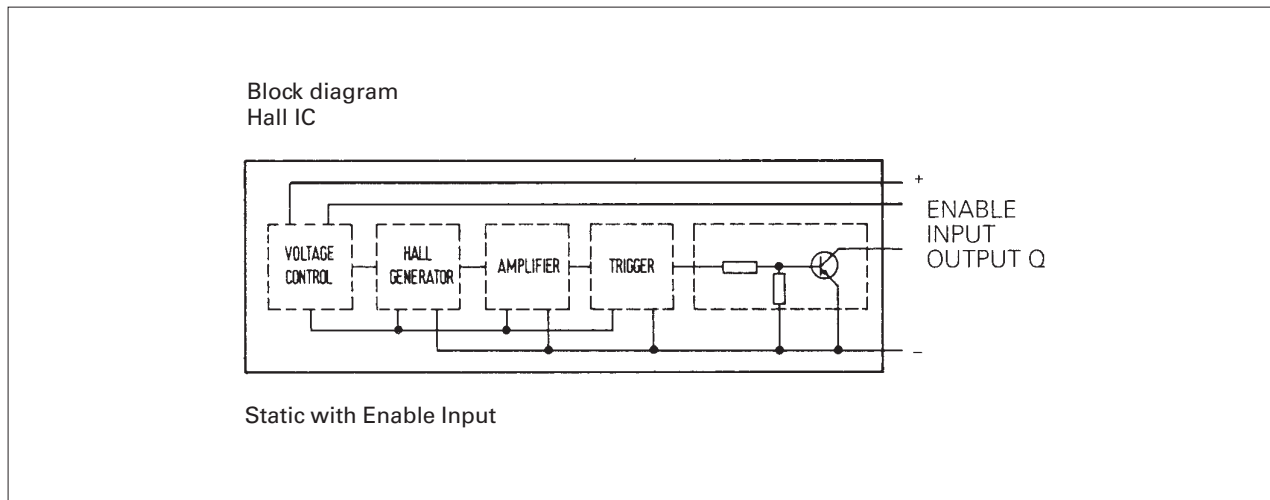
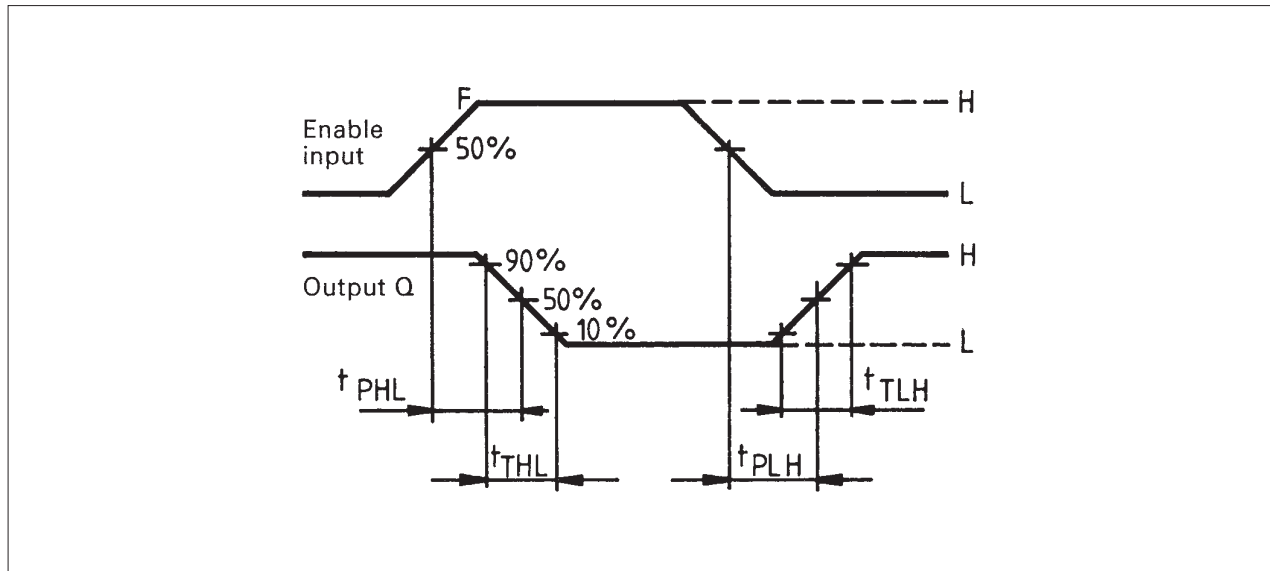

4

RS
76

Examples for Application RS 76 C

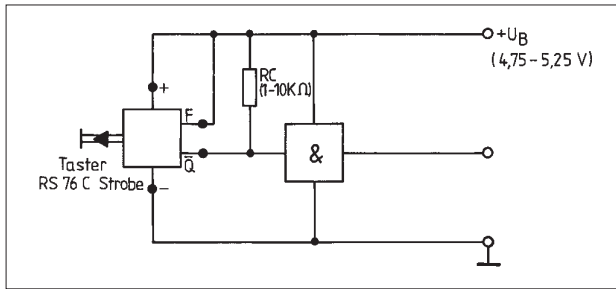

Driving of logic components

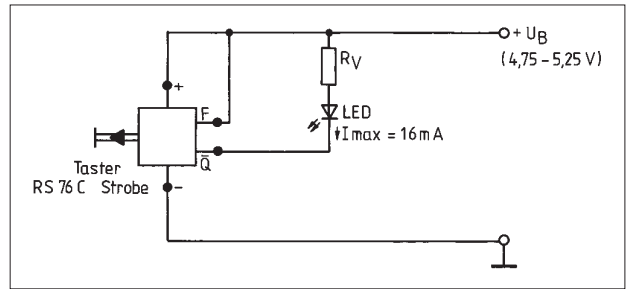

Indication of logical states

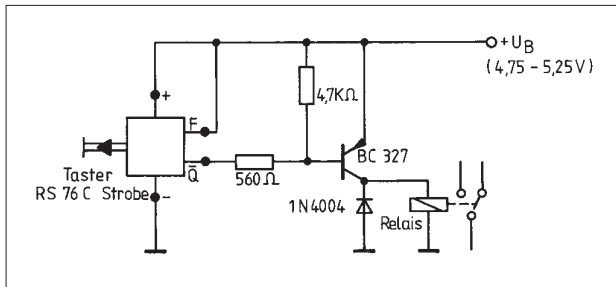

Driving of a PNP transistor

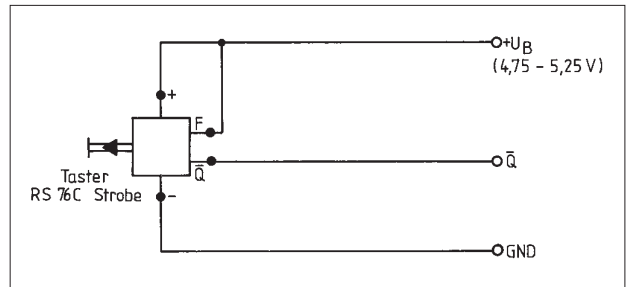

Use as static key with open collector output.
Output transistor (NPN) is conductive when actuated.

4

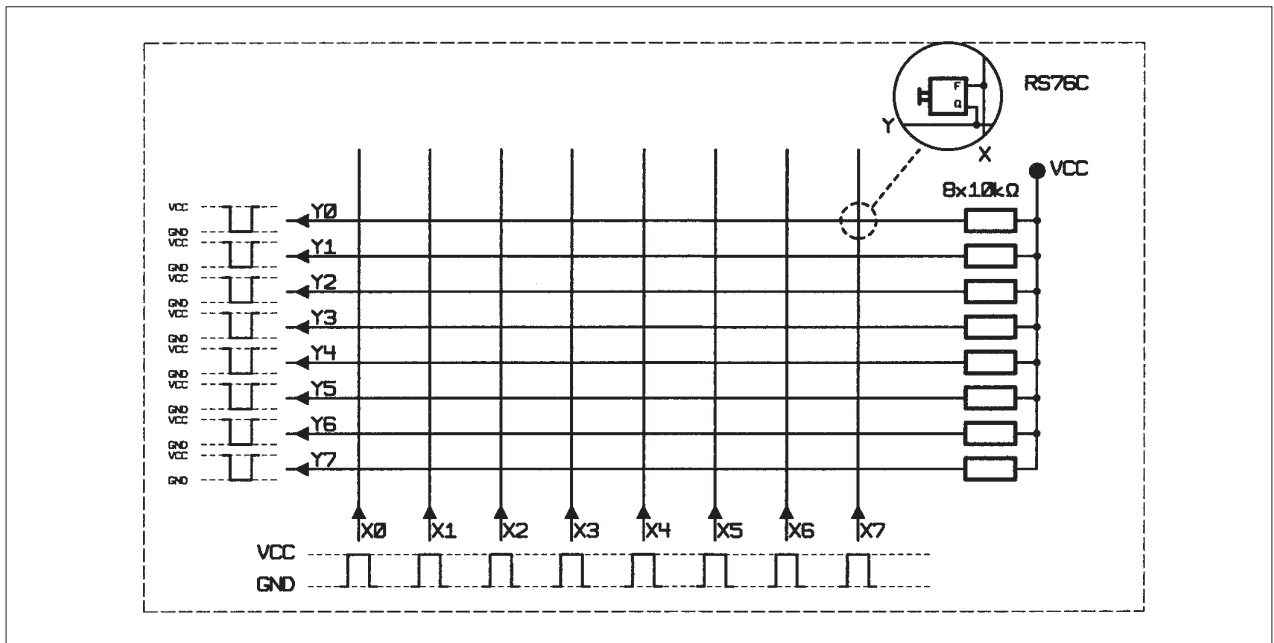

Use in keyboards

RS
76

RS 76 M - Full-travel keyswitch, not illuminable



Technical Data

General information		Rated power max.	1 W
Recommended key grid	19.05 mm	Contact resistance when new max.	100 mΩ (without diode)
Mechanical design		Contact resistance acc. to life max.	3 Ω (without diode)
Contact function	momentary	Insulation resistance	10 ⁹ Ω
Mounting	soldering	ESD strength max.	8 kV
Terminals	solder terminals, tin-plated	Bouncing time max.	5 ms
Contact system	cross contact	Other specifications	
Contact arrangement	1 NO	Ambient temp. operating min.	-25 °C
Contact materials	Au alloy	Ambient temp. operating max.	+70 °C
Illumination	no	Storage temperature min.	-40 °C
Mechanical characteristics		Storage temperature max. (product)	+80 °C
Operating force max.	see order block	Storage temperature max. (rail)	+50 °C
Operating travel	4 mm	Environmental resistance	acc. to IEC 60068-2 -14, -30, -33 and -78
Switching travel	1.5 - 2.8 mm	Operating life min. (operations)	10 ⁷
Robustness min.	100 N	Degree of protection	IP40
Electrical characteristics		Flammability of materials	UL 94 HB
Rated voltage min.	2 V (with Diode 3 V)		
Rated voltage max.	35 V		
Rated current min.	0.01 mA		
Rated current max.	100 mA		

4

Typical accessories RS 76 M - Full-travel keyswitch, not illuminable

Description	Photo	Order no.	Additional accessories see page
RS 76 C - Keycap with legend insert		5.04.665.221/5520	4 - 143
RS 76 C - Keycap, opaque, with nail protection		5.80.000.000/0152	4 - 142
RS 76 C - Keycap, opaque		5.82.000.000/0152	4 - 142

RS 76

RS 76 M - Full-travel keyswitch, not illuminable

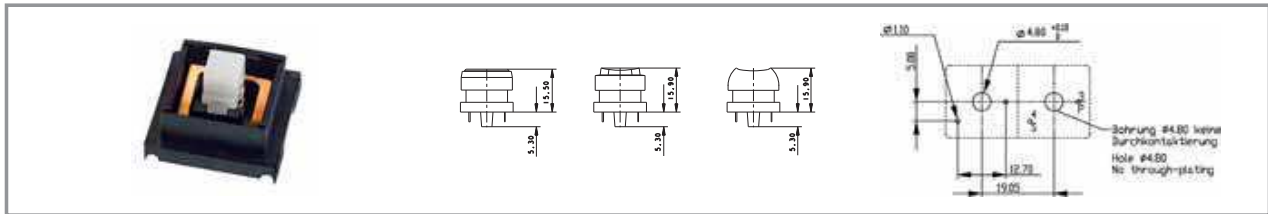

Contact function	Illumination	Contact arrangement	Contact materials	Operating travel	Operating force max.	Bestell-Nr.
momentary	no	1 NO	Au alloy	4 mm	0.9 N	3.13.002.502/0000
momentary	no	1 NO	Au alloy	4 mm	1.4 N	3.13.002.512/0000

Technical data see page 4 - 132

For accessories, refer to RS 76 special accessories.
For keycaps, see keycaps for RS 76.

RS 76 M - Full-travel keyswitch, with diode, not illuminable

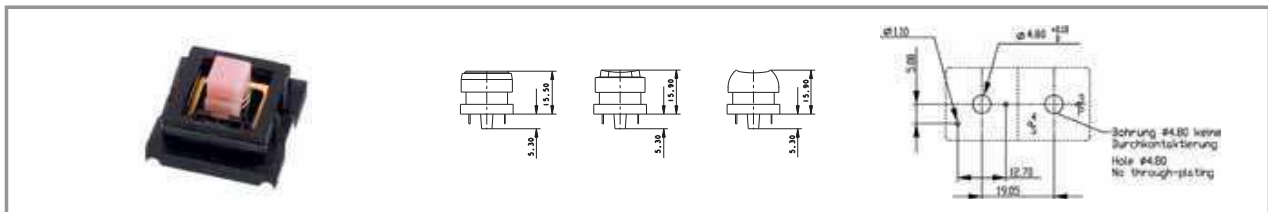

Contact function	Illumination	Contact arrangement	Contact materials	Operating travel	Operating force max.	Bestell-Nr.
momentary	no	1 NO	Au alloy	4 mm	0.9 N	3.13.005.001/0000
momentary	no	1 NO	Au alloy	4 mm	1.4 N	3.13.005.011/0000

Technical data see page 4 - 132

For accessories, refer to RS 76 special accessories.
For keycaps, see keycaps for RS 76.

RS 76 M - Full-travel keyswitch, illuminable



Pict.: RS 76M, for spot illumination

RS 76MX, for full illumination

RS 76MX, keyboard fully illuminated

Technical Data

General information

Recommended key grid 19.05 mm

Mechanical design

Contact function see order block
 Mounting soldering
 Terminals solder terminals, tin-plated
 Contact system bridge contact
 Contact arrangement 1 NO
 Contact materials Au alloy
 Illumination see order block

Mechanical characteristics

Operating force max. 1 N
 Operating travel 4 mm
 Switching travel 1.5 - 2.8 mm
 Robustness min. 100 N

Electrical characteristics

Rated voltage min. 2 V
 Rated voltage max. 35 V
 Rated current min. 0.01 mA
 Rated current max. 100 mA

Rated power max. 1 W
 Contact resistance when new max. 200 mΩ
 Contact resistance acc. to life max. 3 Ω
 Insulation resistance 10⁹ Ω
 ESD strength max. 8 kV
 Bouncing time max. 10 ms

Other specifications

Ambient temp. operating min. -25 °C
 Ambient temp. operating max. +70 °C
 Storage temperature min. -40 °C
 Storage temperature max. (product) +80 °C
 Storage temperature max. (rail) +50 °C
 Environmental resistance acc. to IEC 60068-2 -14, -30, -33 and -78
 Operating life min. (operations) 10⁷ momentary, 10⁵ latching
 Degree of protection IP40
 Flammability of materials UL 94 HB

4

Typical accessories RS 76 M - Full-travel keyswitch, illuminable

Description	Photo	Order no.	Additional accessories see page
RS 76 - Cover IP40, 1-module, charcoal grey		5.04.520.174/0152	4 - 151
RS 76 C - Keycap, illuminated, with legend insert		5.04.665.521/5520	4 - 144
RS 76 C - Keycap, illuminated, with nail protection and legend insert		5.04.665.911/5520	4 - 145
RS 76 C - Keycap with light bar		5.82.110.000/0242	4 - 144

RS 76

RS 76 MX - Full-travel keyswitch, fully illuminable

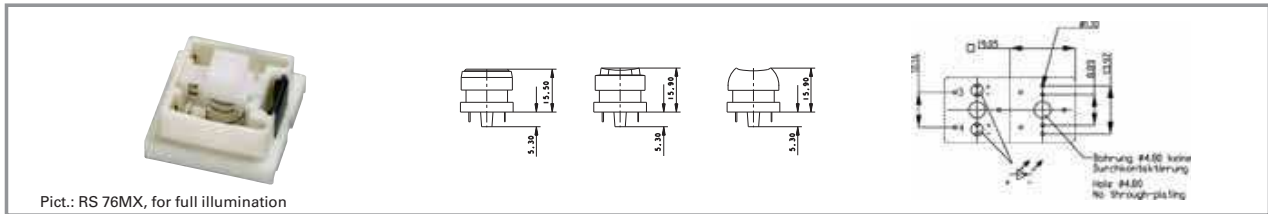

Pict.: RS 76MX, for full illumination

Contact function	Contact system	Illumination	Recommended key grid	Order no.
momentary	bridge contact	2 SMT LED needed	19.05 mm	3.13.002.922/0000

Technical data see page 4 - 134

Accessoires:

RS 76 MX - Keycap, fully illuminated: 5.05.511.168/0209

RS 76 MX - Keycap, fully illuminated: 5.05.511.168/0754

For accessories, refer to RS 76 special accessories.

For keycaps, see keycaps for RS 76.

The SMT LEDs are soldered on the back of the printed circuit board and shine through openings in the board and keyswitch housing.

RS 76 C - Full-travel keyswitch, not illuminable

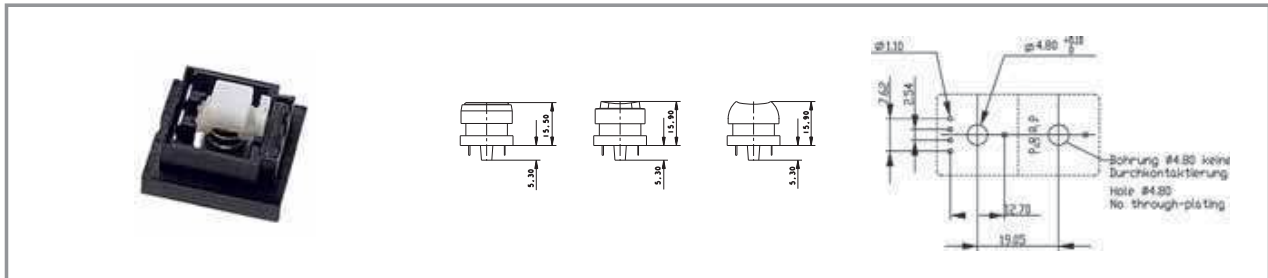

Technical Data

General information

Recommended key grid 19.05 mm

Mechanical design

Contact function momentary
 Mounting soldering
 Terminals solder terminals, tin-plated
 Contact system contactless with Hall-IC
 Illumination no

Output saturation voltage (Q) max. bei 16 mA 0.4 V
 ESD strength max. 8 kV
 Output switching times (Q) at 25 °C, t_{PHL} 3 µs
 Output switching times (Q) at 25 °C, t_{PLH} 4 µs
 Output switching times (Q) at 25 °C, t_{THL} 1 µs
 Output switching times (Q) at 25 °C, t_{TLH} 2 µs

Mechanical characteristics

Switching travel off 0.8 ... 2.4 mm
 Operating force max. see order block
 Operating travel 4 mm
 Switching travel on 1.5 - 2.8 mm
 Robustness min. 100 N

Other specifications

Reliability of Hall-IC at 25 °C $\lambda = 2.5 \times 10^{-7} \text{ h}^{-1}$
 Ambient temp. operating min. 0 °C
 Ambient temp. operating max. +70 °C
 Storage temperature min. -40 °C
 Storage temperature max. (product) +80 °C
 Storage temperature max. (rail) +50 °C
 Environmental resistance acc. to IEC 60068-2 -14, -30, -33 and -78
 Operating life min. (operations) see order block
 Degree of protection IP40
 Flammability of materials UL 94 HB

Electrical characteristics

Operating voltage DC 4.75 ... 5.25 V
 Supply current max. at U_{IL} = 0 V 0.5 mA
 Supply current max. at U_{IH} = 5 V 5 mA
 Input voltage (F) at U_{IL} = 0 V 0.4 V
 Input voltage (F) at U_{IH} = 2.4V 5.25 V
 Output load current (Q) max. 16 mA
 Output residual current (Q) max. 10 µA

4

Typical accessories RS 76 C - Full-travel keyswitch, not illuminable

Description	Photo	Order no.	Additional accessories see page
RS 76 C - Keycap with legend insert		5.04.665.221/5520	4 - 143
RS 76 C - Keycap, opaque, with nail protection		5.80.000.000/0152	4 - 142
RS 76 C - Keycap, opaque		5.82.000.000/0152	4 - 142

RS 76

RS 76 C - Full-travel keyswitch, illuminable

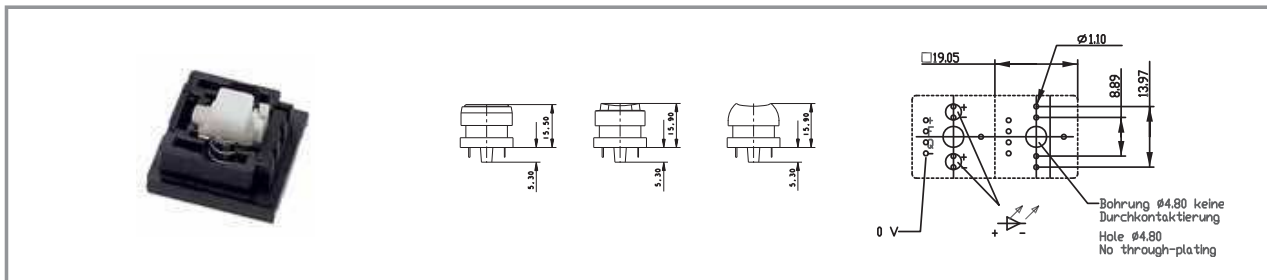

Technical Data

General information

Recommended key grid 19.05 mm

Mechanical design

Contact function see order block
 Mounting soldering
 Terminals solder terminals, tin-plated

Contact system contactless with Hall-IC

Illumination with LED
 LED colour see order block

Mechanical characteristics

Switching travel on 1.5 - 2.8 mm
 Switching travel off 0.8 ... 2.4 mm
 Operating force max. 0.7 N
 Operating travel 4 mm
 Robustness min. 100 N

Electrical characteristics

Number of LED see order block
 Operating voltage DC 4.75 ... 5.25 V
 Supply current max. at $U_{IL} = 0 V$ 0.5 mA
 Supply current max. at $U_{IH} = 5 V$ 5 mA
 Input voltage (F) at $U_{IL} = 0 V$ 0.4 V
 Input voltage (F) at $U_{IH} = 2.4 V$ 5.25 V
 Output load current (Q) max. 16 mA

Output residual current (Q) max. 10 μA
 Output saturation voltage (Q) max. bei 16 mA 0.4 V
 ESD strength max. 8 kV
 Output switching times (Q) at 25 °C, t_{PHL} 3 μs
 Output switching times (Q) at 25 °C, t_{PLH} 4 μs
 Output switching times (Q) at 25 °C, t_{THL} 1 μs
 Output switching times (Q) at 25 °C, t_{TLH} 2 μs

Other specifications

Reliability of Hall-IC at 25 °C $\lambda = 2.5 \times 10^{-7} h^{-1}$
 Ambient temp. operating min. 0 °C
 Ambient temp. operating max. +70 °C
 Storage temperature min. -40 °C
 Storage temperature max. +80 °C (product)
 Storage temperature max. +50 °C (rail)
 Environmental resistance acc. to IEC 60068-2 -14, -30, -33 and -78
 Operating life min. (operations) see order block
 Degree of protection IP40
 Flammability of materials UL 94 HB

4

Typical accessories RS 76 C - Full-travel keyswitch, illuminable

Description	Photo	Order no.	Additional accessories see page
RS 76 - Cover IP40, 1-module, light grey		5.04.520.174/0242	4 - 151
RS 76 C - Keycap, illuminated, with legend insert		5.04.665.521/5520	4 - 144
RS 76 C - Keycap, illuminated, with nail protection and legend insert		5.04.665.911/5520	4 - 145

RS 76

Typical accessories RS 76 C - Full-travel keyswitch, illuminable

Description	Photo	Order no.	Additional accessories see page
RS 76 C - Keycap with light bar		5.82.110.000/0242	4 - 144

RS 76 C - Full-travel keyswitch, illuminable, momentary

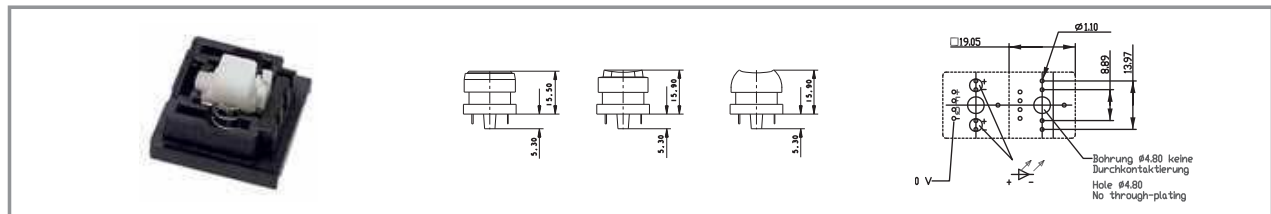

Contact function	Operating life min. (operations)	Illumination	Operating force max.	Operating travel	Order no.
momentary	10 ⁸	with LED	0.7 N	4 mm	3.13.001.110/0000

Technical data see page 4 - 140

RS 76 C - Full-travel keyswitch, illuminable, latching

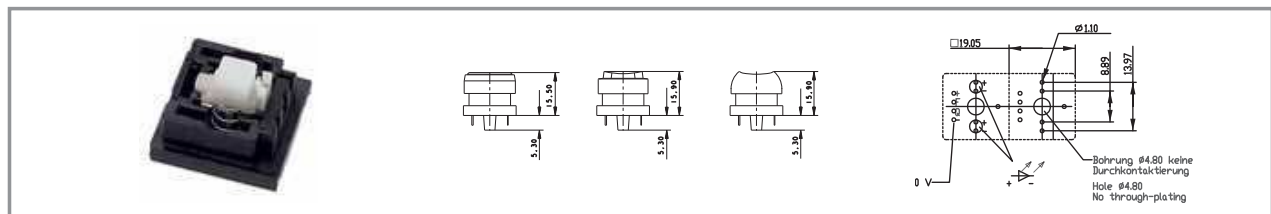

Contact function	Operating life min. (operations)	Illumination	Operating force max.	Operating travel	Order no.
latching	10 ⁵	with LED	0.7 N	4 mm	3.13.001.130/0000

Technical data see page 4 - 140

4

RS 76 - Keycap with legend insert



Pict.: transparent colourless

Size of keycap	Illumination	Colour of keycap / legending	Colour of lens / legend insert	Order no.
1-module	no	charcoal grey/-	colourless/white	5.04.665.221/5520
1-module	no	light grey/-	colourless/white	5.04.665.230/5520

Supplied as single parts: Mat lens, legend insert, keycap body.

Other colours on request.

RS 76 - Keycaps, illuminable



RS 76 - Keycap with light bar



Size of keycap	Illumination	Colour of keycap / legending	Colour of lens / legend insert	Order no.
1-module	yes	light grey/-	-	5.82.110.000/0242
1-module	yes	charcoal grey/-	-	5.82.110.000/0152

Other colours on request.

4

RS 76 - Keycap, illuminable, with legend insert



Size of keycap	Illumination	Colour of keycap / legending	Colour of lens / legend insert	Order no.
1-module	yes	charcoal grey/-	colourless/white	5.04.665.521/5520
1-module	yes	light grey/-	colourless/white	5.04.665.530/5520

Supplied as single parts: Mat lens, legend insert, diffuser foil, keycap body.
Other colours on request.

RS
76

RS 76 - Keycap, illuminable, with nail protection and legend insert



Pict.: light grey, yellow lens

Size of keycap	Illumination	Colour of keycap / legending	Colour of lens / legend insert	Order no.
1-module	yes	charcoal grey/-	colourless/white	5.04.665.911/5520
1-module	yes	light grey/-	colourless/white	5.04.665.920/5520

Supplied as single parts: Mat lens, legend insert, keycap body.
Other colours on request.

RS 76 - Keycap, illuminable, with legend insert



Pict.: light grey, red lens

Size of keycap	Illumination	Colour of keycap / legending	Colour of lens / legend insert	Order no.
1-module	yes	charcoal grey/-	colourless/white	5.04.665.161/5520
1-module	yes	light grey/-	colourless/white	5.04.665.170/5520

Supplied as single parts: Mat lens, legend insert, diffuser foil, keycap body.
Other colours on request.

RS 76 MX - Keycap, fully illuminable



RS 76MX, keyboard fully illuminated

Size of keycap	Illumination	Colour of keycap / legending	Colour of lens / legend insert	Order no.
1-module	yes	white/-	white translucent/-	5.05.511.168/0209
1-module	yes	light grey/-	white translucent/-	5.05.511.168/0754
1¼-module	yes	white/-	white translucent/-	5.05.511.169/0209
1½-module	yes	white/-	white translucent/-	5.05.511.170/0209
1¾-module	yes	white/-	white translucent/-	5.05.511.171/0209
1¼-module with light conductor	yes	white/-	white translucent/-	5.05.511.173/0209

Laser-printed versions available on request.

RS 76 - Keycaps, with legend, two-shot moulded/keycap sets



RS 76 - Keycap set, symbols A-Z

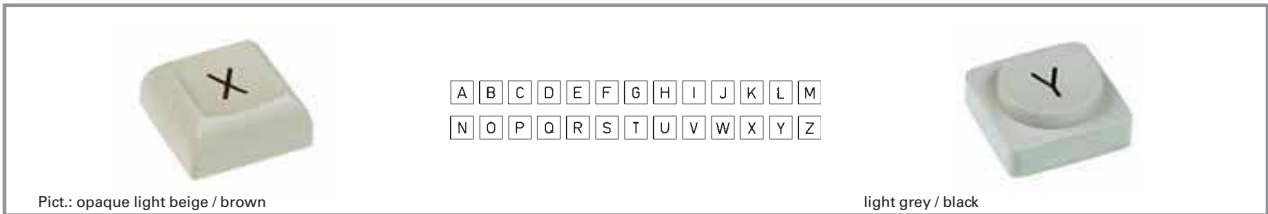

Size of keycap	Form of lens	Colour of keycap / legending	Symbol	Order no.
1-module	keycap opaque with nail protection	charcoal grey/white	A-Z	5.00.999.500/0000
1-module	keycap opaque with nail protection	light grey/black	A-Z	5.00.999.824/0000
1-module	keycap opaque	charcoal grey/white	A-Z	5.00.999.525/0000
1-module	keycap opaque	light grey/black	A-Z	5.00.999.825/0000

Other symbols and colours on request.

4

RS
76

RS 76 - Keycap set, symbols 0-9

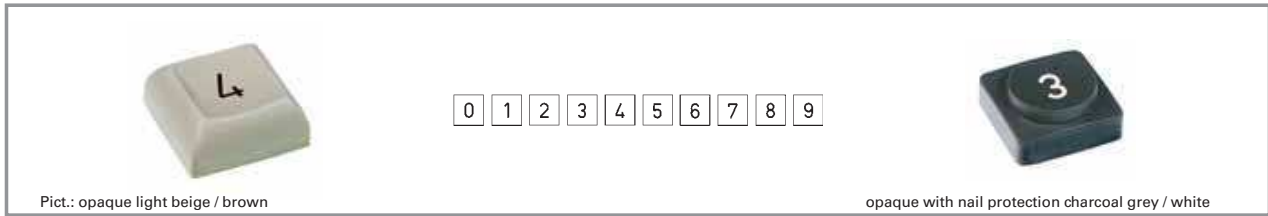

Pict.: opaque light beige / brown

opaque with nail protection charcoal grey / white

Size of keycap	Form of lens	Colour of keycap / legending	Symbol	Order no.
1-module	keycap opaque with nail protection	charcoal grey/white	0-9	5.00.999.504/0000
1-module	keycap opaque with nail protection	light grey/black	0-9	5.00.999.826/0000
1-module	keycap opaque	charcoal grey/white	0-9	5.00.999.529/0000
1-module	keycap opaque	light grey/black	0-9	5.00.999.827/0000

Other symbols and colours on request.

RS 76 - Accessories



Pict.: light beige



dark grey

RS 76 - Cover IP40

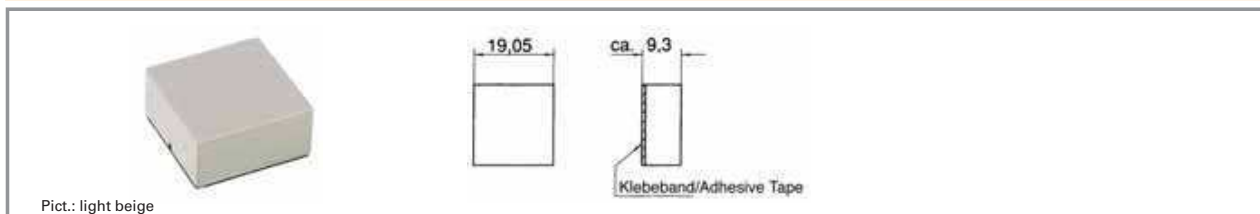

Short text	Feature 1	Feature 2	Order no.
RS 76 - Cover IP40, 1/4-module, charcoal grey	charcoal grey	1/4-module	5.04.520.171/0152
RS 76 - Cover IP40, 1/4-module, light grey	light grey	1/4-module	5.04.520.171/0242
RS 76 - Cover IP40, 1/4-module, light beige	light beige	1/4-module	5.04.520.171/0710
RS 76 - Cover IP40, 1/4-module, dark grey	dark grey	1/4-module	5.04.520.171/0801
RS 76 - Cover IP40, 1/2-module, charcoal grey	charcoal grey	1/2-module	5.04.520.172/0152
RS 76 - Cover IP40, 1/2-module, light grey	light grey	1/2-module	5.04.520.172/0242
RS 76 - Cover IP40, 1/2-module, light beige	light beige	1/2-module	5.04.520.172/0710
RS 76 - Cover IP40, 1/2-module, dark grey	dark grey	1/2-module	5.04.520.172/0801
RS 76 - Cover IP40, 3/4-module, charcoal grey	charcoal grey	3/4-module	5.04.520.173/0152
RS 76 - Cover IP40, 3/4-module, light grey	light grey	3/4-module	5.04.520.173/0242
RS 76 - Cover IP40, 3/4-module, light beige	light beige	3/4-module	5.04.520.173/0710
RS 76 - Cover IP40, 3/4-module, dark grey	dark grey	3/4-module	5.04.520.173/0801
RS 76 - Cover IP40, 1-module, charcoal grey	charcoal grey	1-module	5.04.520.174/0152
RS 76 - Cover IP40, 1-module, light grey	light grey	1-module	5.04.520.174/0242
RS 76 - Cover IP40, 1-module, light beige	light beige	1-module	5.04.520.174/0710
RS 76 - Cover IP40, 1-module, dark grey	dark grey	1-module	5.04.520.174/0801

Other colours on request.

4



General Data

Keylock switches for PCB mounting. Matching with the RS 76 full-travel keyswitches and the RF 15 and RF 19 short-travel keyswitches.

Content

MICROMEK - Keylock switch IP54	4 - 154
MICROMEK - Keylock switch IP54	4 - 156
EUROLOCKS - Keylock switch IP54	4 - 158
EUROLOCKS - Keylock switch IP54	4 - 159
Priority keylock switch IP54	4 - 160
Priority keylock switch IP54	4 - 161
Rotary switch IP40	4 - 162
Rotary switch IP40	4 - 163

MICROMEK - Keylock switch IP54

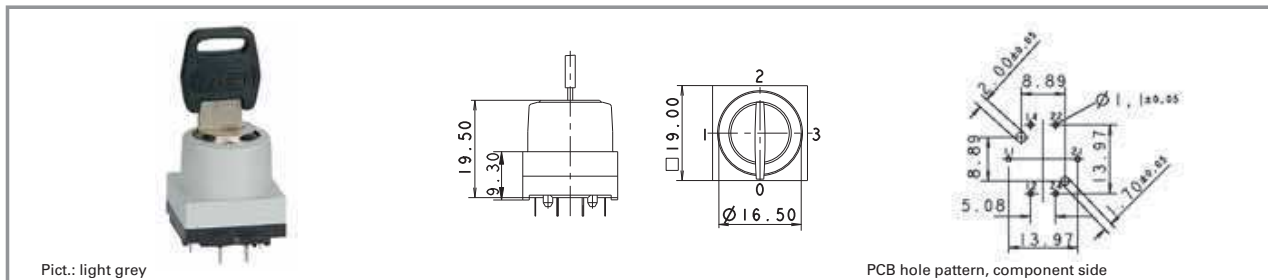

Pict.: light grey

PCB hole pattern, component side

Technical Data

General information

Colour see order block
Form of collar square

Dimensions

Length of collar 19 mm
Width of collar 19 mm
Overall height 19.5 mm

Mechanical design

Mounting soldering
Terminals tin-plated
Contact system cross contact self cleaning

Contact function see order block
Contact materials Au alloy
Illuminability no
Lock Micromec
Wafers 5
Lock type 001
Number of locking positions 500
Main key on request
Key removal position see order block

Mechanical characteristics

Switching torque 0.04 ... 0.10 Nm
Robustness max. 2 Nm
Dielectric strength AC min. 500 V
Rated power max. 1 W

Electrical characteristics

Rated voltage 2 ... 35 V
Rated current max. 100 mA
Contact resistance when new max. 100 mΩ
Contact resistance acc. to life max. 200 mΩ
Insulation resistance 10⁹ Ω
ESD strength max. 8 kV

Other specifications

Rotating angle see order block
Operating life 10,000
Degree of protection from front side IP54
Ambient temp. operating min. -25 °C
Ambient temp. operating max. +70 °C
Storage temperature min. -40 °C
Storage temperature max. +80 °C
Environmental resistance acc. to IEC 60068-2 -14, -30, -33 and -78
Flammability of materials UL 94 HB

4

Typical accessories MICROMEK - Keylock switch IP54

Description	Photo	Order no.	Additional accessories see page
O-ring for keylock switch		5.30.120.015/0100	5 - 25
Spare key, for single action, e.g. 1 x 90° (delivery content 1 key)		5.58.007.001/0000	
Spare key, for double action, e.g. 2 x 90° (delivery content 1 key)		5.58.008.001/0000	
Spare key for 3 angles, f.ex. 3 x 90° degree (content 1 key)		5.58.009.001/0100	

MICROMEK - Keylock switch IP54

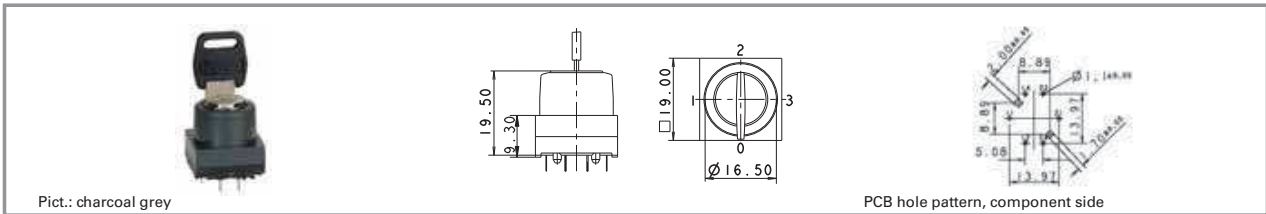

Pict.: charcoal grey

PCB hole pattern, component side

Contact function	Colour	Rotating angle		Key removal position	Order no.
momentary	charcoal grey	1 x 40°		0	3.13.026.041/0000
momentary	light grey	1 x 40°		0	3.13.026.541/0000
latching	charcoal grey	1 x 90°		0	3.13.026.001/0000
latching	light grey	1 x 90°		0	3.13.026.501/0000
latching	charcoal grey	1 x 90°		0+1	3.13.026.006/0000
latching	light grey	1 x 90°		0+1	3.13.026.506/0000
latching	charcoal grey	2 x 90°		0	3.13.026.011/0000
latching	light grey	2 x 90°		0	3.13.026.511/0000
latching	charcoal grey	2 x 90°		0+1+2	3.13.026.016/0000
latching	light grey	2 x 90°		0+1+2	3.13.026.516/0000
latching	charcoal grey	2 x 90°		0	3.13.026.601/0000
latching	light grey	2 x 90°		0	3.13.026.851/0000
latching	charcoal grey	2 x 90°		0+1+3	3.13.026.606/0000
latching	light grey	2 x 90°		0+1+3	3.13.026.856/0000
latching	charcoal grey	3 x 90°		0	3.13.026.021/0000
latching	light grey	3 x 90°		0	3.13.026.521/0000
latching	charcoal grey	3 x 90°		0+1+2+3	3.13.026.026/0000
latching	light grey	3 x 90°		0+1+2+3	3.13.026.526/0000
latching	charcoal grey	4 x 90° without stop		0	3.13.026.031/0000
latching	light grey	4 x 90° without stop		0	3.13.026.531/0000
latching	charcoal grey	4 x 90° without stop		0+1+2+3	3.13.026.036/0000
latching	light grey	4 x 90° without stop		0+1+2+3	3.13.026.536/0000

Technical data see page 4 - 154

2 keys included.

Other lock variants available on request.

4

Key
Swit-
ches

4 - 156

Stock items are marked
by bold printed order numbers.

PCB Keyswitches

EUROLOCKS - Keylock switch IP54

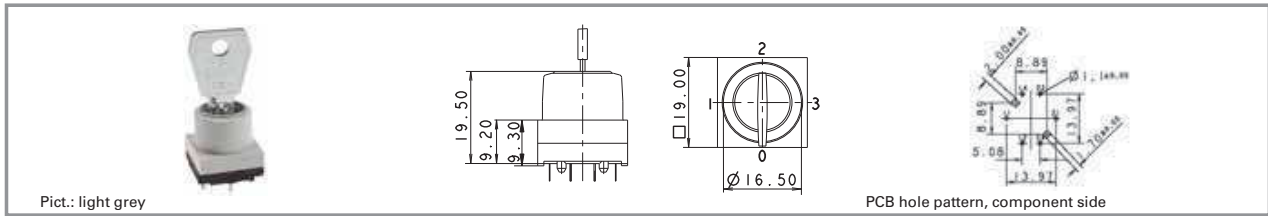

Contact function	Colour	Rotating angle		Key removal position	Order no.
latching	charcoal grey	1 x 90°		0	3.13.009.001/0000
latching	light grey	1 x 90°		0	3.13.009.006/0000
latching	charcoal grey	1 x 90°		0+1	3.13.009.031/0000
latching	light grey	1 x 90°		0+1	3.13.009.036/0000

Technical data see page 4 - 158

2 keys included.

Other lock variants available on request.

For the switching arrangement, refer to Micromec keylock switch IP54.

Priority keylock switch IP54

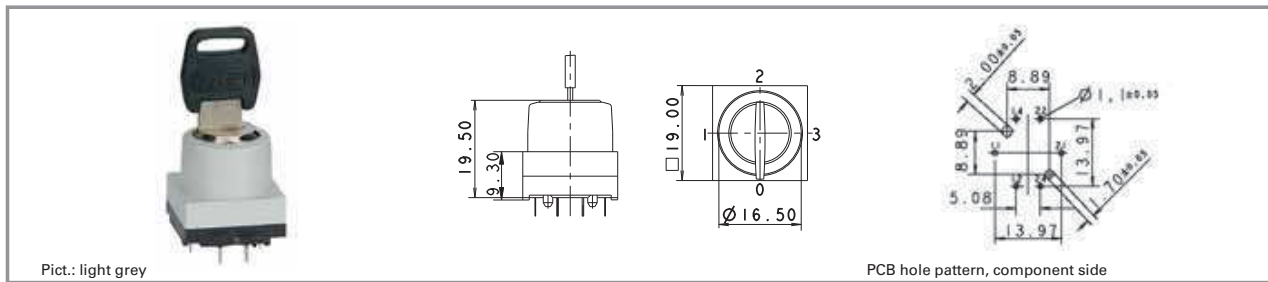

General Data

Either 2 or 3 different keys are required, depending on the angle between positions. Key 1 can switch to position 1, key 2 can switch to position 1 and 2, etc.

Technical Data

General information

Colour see order block
Form of collar square

Dimensions

Length of collar 19 mm
Width of collar 19 mm
Overall height 19.5 mm

Mechanical design

Mounting soldering
Terminals tin-plated
Contact system cross contact self cleaning
Contact function see order block
Contact materials Au alloy
Illuminability no
Lock Micromec
Wafers 5
Lock type 001
Number of locking positions 500
Main key on request
Key removal position see order block

Mechanical characteristics

Switching torque 0.04 ... 0.10 Nm
Robustness max. 2 Nm
Dielectric strength AC min. 500 V
Rated power max. 1 W

Electrical characteristics

Rated voltage 2 ... 35 V
Rated current max. 100 mA
Contact resistance when new max. 100 mΩ
Contact resistance acc. to life max. 200 mΩ
Insulation resistance 10⁹ Ω
ESD strength max. 8 kV

Other specifications

Rotating angle see order block
Operating life 10,000
Degree of protection from front side IP54
Ambient temp. operating min. -25 °C
Ambient temp. operating max. +70 °C
Storage temperature min. -40 °C
Storage temperature max. +80 °C
Environmental resistance acc. to IEC 60068-2 -14, -30, -33 and -78
Flammability of materials UL 94 HB

4

Typical accessories Priority keylock switch IP54

Description	Photo	Order no.	Additional accessories see page
O-ring for keylock switch		5.30.120.015/0100	5 - 25

Rotary switch IP40

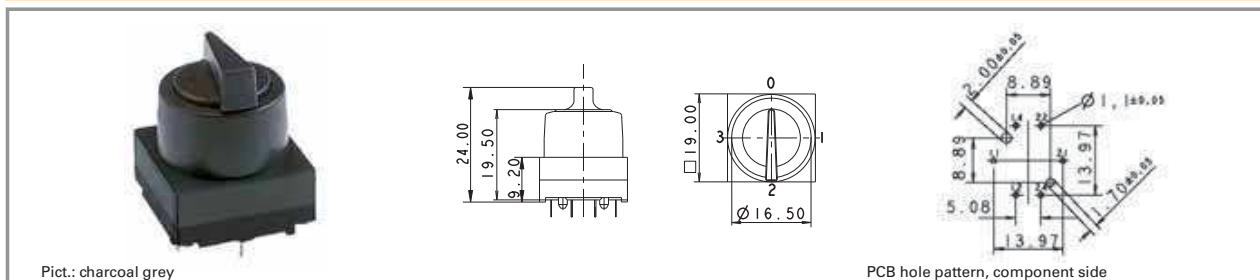

Pict.: charcoal grey

PCB hole pattern, component side

Technical Data

General information

Colour	see order block
Form of collar	square

Dimensions

Length of collar	19 mm
Width of collar	19 mm
Overall height	24 mm

Mechanical design

Mounting	soldering
Terminals	tin-plated
Contact system	cross contact self cleaning

Contact function	see order block
Contact materials	Au alloy
Illuminability	no

Mechanical characteristics

Torque against stop min.	0.45 Nm
Dielectric strength AC min.	see order block
Rated power max.	1 W

Electrical characteristics

Rated voltage max.	35 V
Rated current max.	100 mA
Contact resistance when new max.	100 mΩ
Contact resistance acc. to life max.	200 mΩ
Insulation resistance	10 ⁹ Ω
ESD strength max.	8 kV

Other specifications

Rotating angle	see order block
Operating life	50,000
Degree of protection from front side	IP40
Ambient temp. operating min.	-25 °C
Ambient temp. operating max.	+70 °C
Storage temperature min.	-40 °C
Storage temperature max.	+80 °C
Environmental resistance	acc. to IEC 60068-2 -14, -30, -33 and -78
Flammability of materials	UL 94 HB

4

