

Single Cell Li-Ion Battery Fuel Gauge for Battery Pack Integration

: bq27541-G1

FEATURES

- **Battery Fuel Gauge for 1-Series (1sXp) Li-Ion Applications up to 32Ahr capacity**
- **Microcontroller Peripheral Provides:**
 - **Accurate Battery Fuel Gauging Update to 32Ahr**
 - **Internal Temperature Sensor for System Temperature Reporting**
 - **SHA-1/HMAC Authentication**
 - **Lifetime Data Logging**
 - **64 Bytes of Non-Volatile Scratch Pad FLASH**
- **Battery Fuel Gauging Based on Patented Impedance Track™ Technology**
 - **Models Battery Discharge Curve for Accurate Time-To-Empty Predictions**
 - **Automatically Adjusts for Battery Aging, Battery Self-Discharge, and Temperature/Rate Inefficiencies**
 - **Low-Value Sense Resistor (5mΩ to 20mΩ)**
- **Advanced Fuel Gauging Features**
 - **Internal Short Detection**
 - **Tab Disconnection Detection**
- **HDQ and I²C™ Interface Formats for Communication With Host System**
- **Small 12-pin 2.5 mm × 4 mm SON Package**

APPLICATIONS

- **Smartphones**
- **Tablets**
- **Digital Still and Video Cameras**
- **Handheld Terminals**
- **MP3 or Multimedia Players**

DESCRIPTION

The Texas Instruments bq27541-G1 Li-Ion battery fuel gauge is a microcontroller peripheral that provides fuel gauging for single-cell Li-Ion battery packs. The device requires little system microcontroller firmware development for accurate battery fuel gauging. The bq27541-G1 resides within the battery pack or on the system's main-board with an embedded battery (nonremovable).

The bq27541-G1 uses the patented Impedance Track™ algorithm for fuel gauging, and provides information such as remaining battery capacity (mAh), state-of-charge (%), run-time to empty (min.), battery voltage (mV), and temperature (°C). It also provides detections for internal short or tab disconnection.

The bq27541-G1 also features integrated support for secure battery pack authentication, using the SHA-1/HMAC authentication algorithm.

TYPICAL APPLICATION

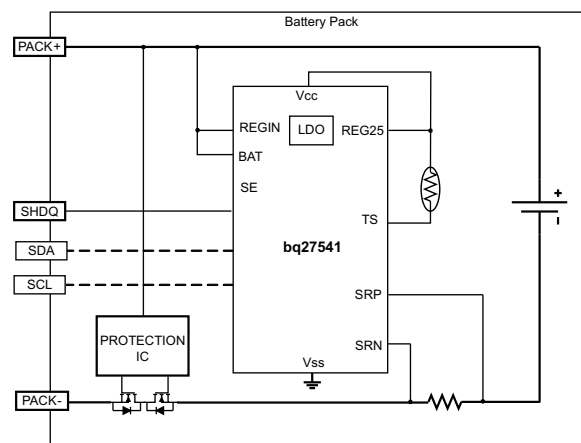

Please be aware that an important notice concerning availability, standard warranty, and use in critical applications of Texas Instruments semiconductor products and disclaimers thereto appears at the end of this data sheet.

Impedance Track is a trademark of Texas Instruments.

I²C is a trademark of NXP B.V Corporation.

PRODUCT PREVIEW information concerns products in the formative or design phase of development. Characteristic data and other specifications are design goals. Texas Instruments reserves the right to change or discontinue these products without notice.

Copyright © 2011, Texas Instruments Incorporated

PRODUCTPREVIEW



These devices have limited built-in ESD protection. The leads should be shorted together or the device placed in conductive foam during storage or handling to prevent electrostatic damage to the MOS gates.

DEVICE INFORMATION

AVAILABLE OPTIONS

PRODUCTION PART NO. ⁽¹⁾	PACKAGE	T _A	COMMUNICATION FORMAT	TAPE AND REEL QUANTITY
bq27541DRZR-G1	12-pin, 2.5-mm × 4-mm SON	–40°C to 85°C	I2C, HDQ ⁽¹⁾	3000
bq27541DRZT-G1				250

(1) bq27541-G1 is shipped in I2C mode

**bq27541 PIN DIAGRAM
(TOP VIEW)**

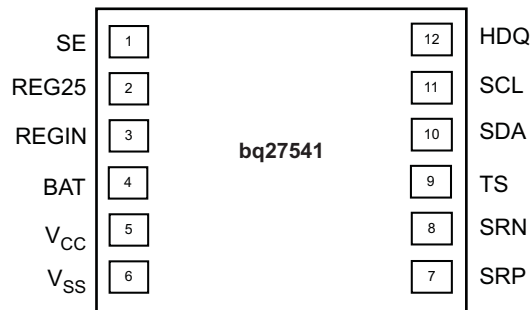

PIN FUNCTIONS

PIN		TYPE ⁽¹⁾	DESCRIPTION
NAME	NO.		
BAT	4	I	Cell-voltage measurement input. ADC input. Decouple with 0.1µF capacitor.
REG25	2	P	2.5V output voltage of the internal integrated LDO. Connect a minimum 0.47µF ceramic capacitor.
REGIN	3	P	The input voltage for the internal integrated LDO. Connect a 0.1µF ceramic capacitor.
SCL	11	I	Slave I ² C serial communications clock input line for communication with system (Slave). Open-drain I/O. Use with 10kΩ pull-up resistor (typical).
SDA	10	I/O	Slave I ² C serial communications data line for communication with system (Slave). Open-drain I/O. Use with 10kΩ pull-up resistor (typical).
SE	1	O	Shutdown Enable output. Push-pull output.
HDQ	12	I/O	HDQ serial communications line (Slave). Open-drain.
SRN	8	IA	Analog input pin connected to the internal coulomb counter with a Kelvin connection where SRN is nearest the PACK- connection. Connect to 5-mΩ to 20-mΩ sense resistor.
SRP	7	IA	Analog input pin connected to the internal coulomb counter with a Kelvin connection where SRP is nearest the CELL- connection. Connect to 5-mΩ to 20-mΩ sense resistor
TS	9	IA	Pack thermistor voltage sense (use 103AT-type thermistor). ADC input
V _{cc}	5	P	Processor power input. The minimum 0.47µF capacitor connected to REG25 should be close to V _{cc} .
V _{ss}	6	P	Device ground

(1) I/O = Digital input/output, IA = Analog input, P = Power connection

ELECTRICAL SPECIFICATIONS

ABSOLUTE MAXIMUM RATINGS

over operating free-air temperature range (unless otherwise noted)⁽¹⁾

		VALUE		UNIT
		MIN	MAX	
V _I	Regulator input, REGIN	-0.3	24	V
V _{CC}	Supply voltage range	-0.3	2.75	V
V _{IOD}	Open-drain I/O pins (SDA, SCL, HDQ)	-0.3	6	V
V _{BAT}	BAT input, (pin 4)	-0.3	6	V
V _I	Input voltage range to all others (pins 1, 7, 8, 9)	-0.3	V _{CC} + 0.3	V
ESD	Human Body Model (HBM), BAT pin		1.5	kV
	Human Body Model (HBM), all pins		2	
T _F	Functional temperature range	-40	100	°C
T _{stg}	Storage temperature range	-65	150	

- (1) Stresses beyond those listed under absolute maximum ratings may cause permanent damage to the device. These are stress ratings only, and functional operation of the device at these or any other conditions beyond those indicated under recommended operating conditions is not implied. Exposure to absolute-maximum-rated conditions for extended periods may affect device reliability.

DISSIPATION RATINGS

PACKAGE ⁽¹⁾	T _A ≤ 40°C POWER RATING	DERATING FACTOR T _A ≤ 40°C	R _{θJA}
12-pin DRZ ⁽²⁾	482 mW	5.67 mW/°C	176°C/W

- (1) For the most current package and ordering information, see the Package Option Addendum at the end of this document, or see the TI website at www.ti.com.
- (2) This data is based on using a 4-layer JEDEC high-K board with the exposed die pad connected to a Cu pad on the board. The board pad is connected to the ground plane by a 2- × 2-via matrix.

RECOMMENDED OPERATING CONDITIONS

T_A = -40°C to 85°C; typical values at T_A = 25°C and V_(REGIN) = V_{BAT} = 3.6 V (unless otherwise noted)

			MIN	TYP	MAX	UNIT
V _I	Supply voltage, REGIN	No operating restrictions	2.7		5.5	V
		No FLASH writes	2.45		2.7	
I _{CC}	Normal operating mode current ⁽¹⁾	Fuel gauge in NORMAL mode. I _{LOAD} > Sleep Current		131		μA
I _(SLP)	Low-power operating mode current ⁽¹⁾	Fuel gauge in SLEEP mode. I _{LOAD} < Sleep Current		60		μA
I _(FULLSLP)	Low-power operating mode current ⁽¹⁾	Fuel gauge in FULLSLEEP mode. I _{LOAD} < Sleep Current		21		μA
I _(HIB)	Hibernate operating mode current ⁽¹⁾	Fuel gauge in HIBERNATE mode. Available in I ² C Mode only. I _{LOAD} < Hibernate Current		6		μA
V _{OL}	Output voltage low (HDQ, SDA, SCL, SE)	I _{OL} = 3 mA			0.4	V
V _{OH(PP)}	Output high voltage (SE)	I _{OH} = -1 mA	V _{CC} -0.5			V
V _{OH(OD)}	Output high voltage (HDQ, SDA, SCL)	External pull-up resistor connected to V _{CC}	V _{CC} -0.5			V
V _{IL}	Input voltage low (HDQ, SDA, SCL)		-0.3		0.6	V
V _{IH}	Input voltage high (HDQ, SDA, SCL)		1.2		6	V
V _(A1)	Input voltage range (TS)		V _{SS} -0.125		2	V
V _(A2)	Input voltage range (BAT)		V _{SS} -0.125		5	V
V _(A3)	Input voltage range (SRP, SRN)		V _{SS} -0.125		0.125	V

- (1) Specified by design. Not tested in production.

RECOMMENDED OPERATING CONDITIONS (continued)

$T_A = -40^\circ\text{C}$ to 85°C ; typical values at $T_A = 25^\circ\text{C}$ and $V_{(\text{REGIN})} = V_{\text{BAT}} = 3.6\text{ V}$ (unless otherwise noted)

		MIN	TYP	MAX	UNIT
I_{IKG}	Input leakage current (I/O pins)			0.3	μA
t_{PUCD}	Power-up communication delay		250		ms

POWER-ON RESET

$T_A = -40^\circ\text{C}$ to 85°C , $C_{(\text{REG})} = 0.47\mu\text{F}$, $2.45\text{ V} < V_{(\text{REGIN})} = V_{\text{BAT}} < 5.5\text{ V}$; typical values at $T_A = 25^\circ\text{C}$ and $V_{(\text{REGIN})} = V_{\text{BAT}} = 3.6\text{ V}$ (unless otherwise noted)

PARAMETER	TEST CONDITIONS	MIN	TYP	MAX	UNIT
$V_{\text{IT+}}$	Positive-going battery voltage input at V_{CC}	2.05	2.20	2.31	V
V_{HYS}	Power-on reset hysteresis	45	115	185	mV

2.5 V LDO REGULATOR⁽¹⁾

$T_A = -40^\circ\text{C}$ to 85°C , $C_{(\text{REG})} = 0.47\mu\text{F}$, $2.45\text{ V} < V_{(\text{REGIN})} = V_{\text{BAT}} < 5.5\text{ V}$; typical values at $T_A = 25^\circ\text{C}$ and $V_{(\text{REGIN})} = V_{\text{BAT}} = 3.6\text{ V}$ (unless otherwise noted)

PARAMETER	TEST CONDITION	MIN	NOM	MAX	UNIT
V_{O}	Regulator output voltage, REG25 $2.7\text{ V} \leq V_{(\text{REGIN})} \leq 5.5\text{ V}$, $I_{\text{OUT}} \leq 16\text{ mA}$	2.4	2.5	2.6	V
	$2.45\text{ V} \leq V_{(\text{REGIN})} < 2.7\text{ V}$ (low battery), $I_{\text{OUT}} \leq 3\text{ mA}$	2.4			V
V_{DO}	Regulator dropout voltage 2.7 V , $I_{\text{OUT}} \leq 16\text{ mA}$			280	mV
	2.45 V , $I_{\text{OUT}} \leq 3\text{ mA}$			50	
$\Delta V_{(\text{REGTEMP})}$	Regulator output change with temperature $V_{(\text{REGIN})} = 3.6\text{ V}$, $I_{\text{OUT}} = 16\text{ mA}$		0.3%		
$\Delta V_{(\text{REGLINE})}$	Line regulation $2.7\text{ V} \leq V_{(\text{REGIN})} \leq 5.5\text{ V}$, $I_{\text{OUT}} = 16\text{ mA}$		11	25	mV
$\Delta V_{(\text{REGLOAD})}$	Load regulation $0.2\text{ mA} \leq I_{\text{OUT}} \leq 3\text{ mA}$, $V_{(\text{REGIN})} = 2.45\text{ V}$		34	40	mV
	$3\text{ mA} \leq I_{\text{OUT}} \leq 16\text{ mA}$, $V_{(\text{REGIN})} = 2.7\text{ V}$		31		
$I_{\text{OS}}^{(2)}$	Short circuit current limit $V_{(\text{REG25})} = 0\text{ V}$			250	mA

(1) LDO output current, I_{OUT} , is the total load current. LDO regulator should be used to power internal fuel gauge only.

(2) Specified by design. Not production tested.

INTERNAL TEMPERATURE SENSOR CHARACTERISTICS

$T_A = -40^\circ\text{C}$ to 85°C , $C_{(\text{REG})} = 0.47\mu\text{F}$, $2.45\text{ V} < V_{(\text{REGIN})} = V_{\text{BAT}} < 5.5\text{ V}$; typical values at $T_A = 25^\circ\text{C}$ and $V_{(\text{REGIN})} = V_{\text{BAT}} = 3.6\text{ V}$ (unless otherwise noted)

PARAMETER	TEST CONDITIONS	MIN	TYP	MAX	UNIT
$G_{(\text{TEMP})}$	Temperature sensor voltage gain		-2.0		$\text{mV}/^\circ\text{C}$

HIGH FREQUENCY OSCILLATOR

$T_A = -40^\circ\text{C}$ to 85°C , $C_{(\text{REG})} = 0.47\mu\text{F}$, $2.45\text{ V} < V_{(\text{REGIN})} = V_{\text{BAT}} < 5.5\text{ V}$; typical values at $T_A = 25^\circ\text{C}$ and $V_{(\text{REGIN})} = V_{\text{BAT}} = 3.6\text{ V}$ (unless otherwise noted)

PARAMETER	TEST CONDITIONS	MIN	TYP	MAX	UNIT
$f_{(\text{OSC})}$	Operating frequency		2.097		MHz
$f_{(\text{EIO})}$	Frequency error ^{(1) (2)}	$T_A = 0^\circ\text{C}$ to 60°C	-2.0%	0.38%	2.0%
	$T_A = -20^\circ\text{C}$ to 70°C	-3.0%	0.38%	3.0%	
	$T_A = -40^\circ\text{C}$ to 85°C	-4.5%	0.38%	4.5%	
$t_{(\text{SXO})}$	Start-up time ⁽³⁾		2.5	5	ms

(1) The frequency error is measured from 2.097 MHz.

(2) The frequency drift is included and measured from the trimmed frequency at $V_{\text{CC}} = 2.5\text{ V}$, $T_A = 25^\circ\text{C}$.

(3) The startup time is defined as the time it takes for the oscillator output frequency to be $\pm 3\%$.

LOW FREQUENCY OSCILLATOR

$T_A = -40^{\circ}\text{C}$ to 85°C , $C_{(\text{REG})} = 0.47\mu\text{F}$, $2.45\text{ V} < V_{(\text{REGIN})} = V_{\text{BAT}} < 5.5\text{ V}$; typical values at $T_A = 25^{\circ}\text{C}$ and $V_{(\text{REGIN})} = V_{\text{BAT}} = 3.6\text{ V}$ (unless otherwise noted)

PARAMETER		TEST CONDITIONS	MIN	TYP	MAX	UNIT
$f_{(\text{LOSC})}$	Operating frequency			32.768		KHz
$f_{(\text{LEIO})}$	Frequency error ^{(1) (2)}	$T_A = 0^{\circ}\text{C}$ to 60°C	-1.5%	0.25%	1.5%	
		$T_A = -20^{\circ}\text{C}$ to 70°C	-2.5%	0.25%	2.5%	
		$T_A = -40^{\circ}\text{C}$ to 85°C	-4.0%	0.25%	4.0%	
$t_{(\text{LSXO})}$	Start-up time ⁽³⁾			500		μs

(1) The frequency drift is included and measured from the trimmed frequency at $V_{\text{CC}} = 2.5\text{ V}$, $T_A = 25^{\circ}\text{C}$.

(2) The frequency error is measured from 32.768 KHz.

(3) The startup time is defined as the time it takes for the oscillator output frequency to be $\pm 3\%$ of typical oscillator frequency.

INTEGRATING ADC (COULOMB COUNTER) CHARACTERISTICS

$T_A = -40^{\circ}\text{C}$ to 85°C , $C_{(\text{REG})} = 0.47\mu\text{F}$, $2.45\text{ V} < V_{(\text{REGIN})} = V_{\text{BAT}} < 5.5\text{ V}$; typical values at $T_A = 25^{\circ}\text{C}$ and $V_{(\text{REGIN})} = V_{\text{BAT}} = 3.6\text{ V}$ (unless otherwise noted)

PARAMETER		TEST CONDITIONS	MIN	TYP	MAX	UNIT
$V_{\text{IN}(\text{SR})}$	Input voltage range, $V_{(\text{SRN})}$ and $V_{(\text{SRP})}$	$V_{\text{SR}} = V_{(\text{SRN})} - V_{(\text{SRP})}$	-0.125		0.125	V
$t_{\text{CONV}(\text{SR})}$	Conversion time	Single conversion		1		s
	Resolution		14		15	bits
$V_{\text{OS}(\text{SR})}$	Input offset			10		μV
I_{NL}	Integral nonlinearity error			± 0.007	± 0.034	FSR
$Z_{\text{IN}(\text{SR})}$	Effective input resistance ⁽¹⁾		2.5			M Ω
$I_{\text{lkq}(\text{SR})}$	Input leakage current ⁽¹⁾				0.3	μA

(1) Specified by design. Not production tested.

ADC (TEMPERATURE AND CELL VOLTAGE) CHARACTERISTICS

$T_A = -40^{\circ}\text{C}$ to 85°C , $C_{(\text{REG})} = 0.47\mu\text{F}$, $2.45\text{ V} < V_{(\text{REGIN})} = V_{\text{BAT}} < 5.5\text{ V}$; typical values at $T_A = 25^{\circ}\text{C}$ and $V_{(\text{REGIN})} = V_{\text{BAT}} = 3.6\text{ V}$ (unless otherwise noted)

PARAMETER		TEST CONDITIONS	MIN	TYP	MAX	UNIT
$V_{\text{IN}(\text{ADC})}$	Input voltage range		-0.2		1	V
$t_{\text{CONV}(\text{ADC})}$	Conversion time				125	ms
	Resolution		14		15	bits
$V_{\text{OS}(\text{ADC})}$	Input offset			1		mV
$Z_{(\text{ADC}1)}$	Effective input resistance (TS) ⁽¹⁾		8			M Ω
$Z_{(\text{ADC}2)}$	Effective input resistance (BAT) ⁽¹⁾	bq27541-G1 not measuring cell voltage	8			M Ω
		bq27541-G1 measuring cell voltage		100		k Ω
$I_{\text{lkq}(\text{ADC})}$	Input leakage current ⁽¹⁾				0.3	μA

(1) Specified by design. Not production tested.

DATA FLASH MEMORY CHARACTERISTICS

$T_A = -40^{\circ}\text{C}$ to 85°C , $C_{(\text{REG})} = 0.47\mu\text{F}$, $2.45\text{ V} < V_{(\text{REGIN})} = V_{\text{BAT}} < 5.5\text{ V}$; typical values at $T_A = 25^{\circ}\text{C}$ and $V_{(\text{REGIN})} = V_{\text{BAT}} = 3.6\text{ V}$ (unless otherwise noted)

PARAMETER		TEST CONDITIONS	MIN	TYP	MAX	UNIT
t_{DR}	Data retention ⁽¹⁾		10			Years
	Flash programming write-cycles ⁽¹⁾		20,000			Cycles
t_{WORDPROG}	Word programming time ⁽¹⁾				2	ms
I_{CCPROG}	Flash-write supply current ⁽¹⁾			5	10	mA

(1) Specified by design. Not production tested.

HDQ COMMUNICATION TIMING CHARACTERISTICS

$T_A = -40^{\circ}\text{C}$ to 85°C , $C_{REG} = 0.47\mu\text{F}$, $2.45\text{ V} < V_{REGIN} = V_{BAT} < 5.5\text{ V}$; typical values at $T_A = 25^{\circ}\text{C}$ and $V_{REGIN} = V_{BAT} = 3.6\text{ V}$ (unless otherwise noted)

PARAMETER	TEST CONDITIONS	MIN	TYP	MAX	UNIT
$t_{(CYCH)}$	Cycle time, host to bq27541-G1	190			μs
$t_{(CYCD)}$	Cycle time, bq27541-G1 to host	190	205	250	μs
$t_{(HW1)}$	Host sends 1 to bq27541-G1	0.5		50	μs
$t_{(DW1)}$	bq27541-G1 sends 1 to host	32		50	μs
$t_{(HW0)}$	Host sends 0 to bq27541-G1	86		145	μs
$t_{(DW0)}$	bq27541-G1 sends 0 to host	80		145	μs
$t_{(RSPS)}$	Response time, bq27541-G1 to host	190		950	μs
$t_{(B)}$	Break time	190			μs
$t_{(BR)}$	Break recovery time	40			μs
$t_{(RISE)}$	HDQ line rising time to logic 1 (1.2V)			950	ns

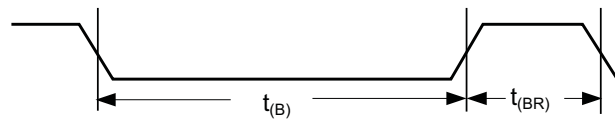

(a) Break and Break Recovery

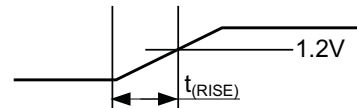

(b) HDQ line rise time

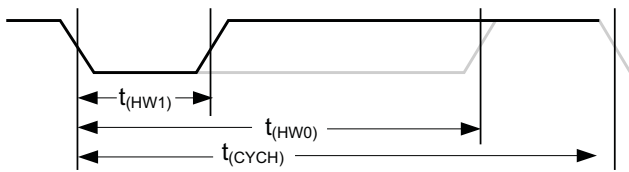

(c) Host Transmitted Bit

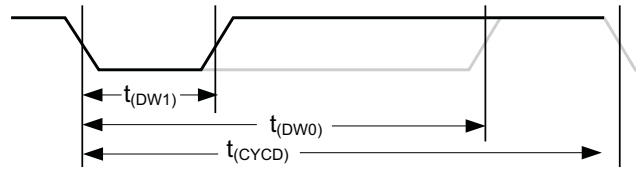

(d) Gauge Transmitted Bit

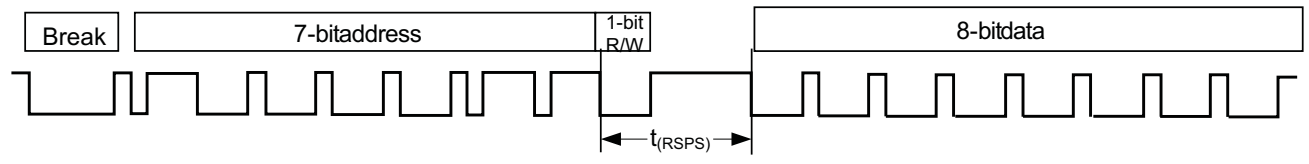

(e) Gauge to Host Response

Figure 1. Timing Diagrams

PRODUCT PREVIEW

I²C-COMPATIBLE INTERFACE TIMING CHARACTERISTICS

T_A = -40°C to 85°C, C_{REG} = 0.47µF, 2.45 V < V_{REGIN} = V_{BAT} < 5.5 V; typical values at T_A = 25°C and V_{REGIN} = V_{BAT} = 3.6 V (unless otherwise noted)

PARAMETER		TEST CONDITIONS	MIN	TYP	MAX	UNIT
t _r	SCL/SDA rise time				300	ns
t _f	SCL/SDA fall time				300	ns
t _{w(H)}	SCL pulse width (high)		600			ns
t _{w(L)}	SCL pulse width (low)		1.3			µs
t _{su(STA)}	Setup for repeated start		600			ns
t _{d(STA)}	Start to first falling edge of SCL		600			ns
t _{su(DAT)}	Data setup time		1000			ns
t _{h(DAT)}	Data hold time		0			ns
t _{su(STOP)}	Setup time for stop		600			ns
t _{BUF}	Bus free time between stop and start		66			µs
f _{SCL}	Clock frequency				400	kHz

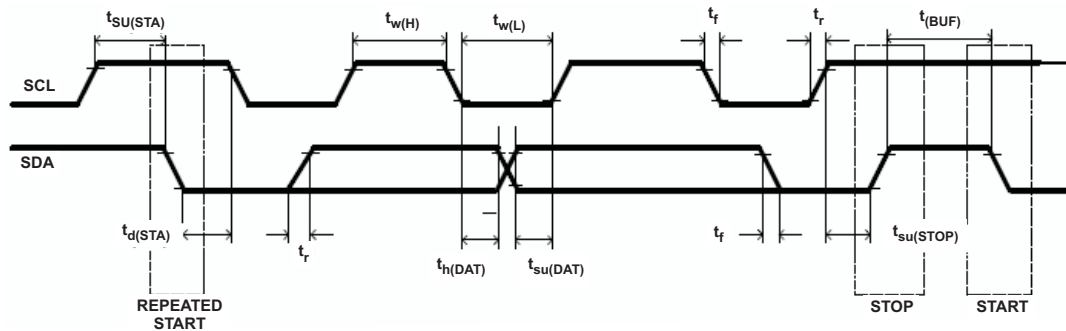

Figure 2. I²C-Compatible Interface Timing Diagrams

GENERAL DESCRIPTION

The bq27541-G1 accurately predicts the battery capacity and other operational characteristics of a single Li-based rechargeable cell. It can be interrogated by a system processor to provide cell information, such as state-of-charge (SOC), time-to-empty (TTE) and time-to-full (TTF).

Information is accessed through a series of commands, called Standard Commands. Further capabilities are provided by the additional Extended Commands set. Both sets of commands, indicated by the general format *Command*(), are used to read and write information contained within the bq27541-G1 control and status registers, as well as its data flash locations. Commands are sent from system to gauge using the bq27541-G1 serial communications engine, and can be executed during application development, pack manufacture, or end-equipment operation.

Cell information is stored in the bq27541-G1 in non-volatile flash memory. Many of these data flash locations are accessible during application development. They cannot, generally, be accessed directly during end-equipment operation. Access to these locations is achieved by either use of the bq27541-G1 companion evaluation software, through individual commands, or through a sequence of data-flash-access commands. To access a desired data flash location, the correct data flash subclass and offset must be known.

The bq27541-G1 provides 64 bytes of user-programmable data flash memory, partitioned into two (2) 32-byte blocks: **Manufacturer Info Block A** and **Manufacturer Info Block B**. This data space is accessed through a data flash interface. For specifics on accessing the data flash, see section Manufacturer Information Blocks. The key to the bq27541-G1 high-accuracy gas gauging prediction is Texas Instrument's proprietary Impedance Track™ algorithm. This algorithm uses cell measurements, characteristics, and properties to create state-of-charge predictions that can achieve less than 1% error across a wide variety of operating conditions and over the lifetime of the battery.

The bq27541-G1 measures charge/discharge activity by monitoring the voltage across a small-value series sense resistor (5 mΩ to 20 mΩ typ.) located between the CELL-and the battery's PACK-terminal. When a cell is attached to the bq27541-G1, cell impedance is learned, based on cell current, cell open-circuit voltage (OCV), and cell voltage under loading conditions.

The bq27541-G1 external temperature sensing is optimized with the use of a high accuracy negative temperature coefficient (NTC) thermistor with $R_{25} = 10k\Omega \pm 1\%$ and $B_{25/85} = 3435k\Omega \pm 1\%$ (such as Semitec 103AT for measurement). The bq27541-G1 can also be configured to use its internal temperature sensor. The bq27541-G1 uses temperature to monitor the battery-pack environment, which is used for fuel gauging and cell protection functionality.

To minimize power consumption, the bq27541-G1 has different power modes: NORMAL, SLEEP, FULLSLEEP, and HIBERNATE. The bq27541-G1 passes automatically between these modes, depending upon the occurrence of specific events, though a system processor can initiate some of these modes directly. More details can be found in section Power Modes.

NOTE

FORMATTING CONVENTIONS IN THIS DOCUMENT:

Commands: *italics with parentheses() and no breaking spaces.* e.g. *RemainingCapacity()*

Data Flash: *italics, bold, and breaking spaces.* e.g. ***Design Capacity***

Register bits and flags: *italics with brackets[].* e.g. *[TDA]*

Data flash bits: *italics, bold, and brackets[].* e.g: ***[LED1]***

Modes and states: ALL CAPITALS. e.g. UNSEALED mode

DATA COMMANDS

STANDARD DATA COMMANDS

The bq27541-G1 uses a series of 2-byte standard commands to enable system reading and writing of battery information. Each standard command has an associated command-code pair, as indicated in [Table 1](#). Each protocol has specific means to access the data at each Command Code. DataRAM is updated and read by the gauge only once per second. Standard commands are accessible in NORMAL operation mode.

Table 1. Standard Commands

NAME		COMMAND CODE	UNITS	SEALED ACCESS
<i>Control()</i>	CNTL	0x00 / 0x01	N/A	R/W
<i>AtRate()</i>	AR	0x02 / 0x03	mA	R/W
<i>AtRateTimeToEmpty()</i>	ARTTE	0x04 / 0x05	Minutes	R
<i>Temperature()</i>	TEMP	0x06 / 0x07	0.1K	R
<i>Voltage()</i>	VOLT	0x08 / 0x09	mV	R
<i>Flags()</i>	FLAGS	0x0a / 0x0b	N/A	R
<i>NominalAvailableCapacity()</i>	NAC	0x0c / 0x0d	mAh	R
<i>FullAvailableCapacity()</i>	FAC	0x0e / 0x0f	mAh	R
<i>RemainingCapacity()</i>	RM	0x10 / 0x11	mAh	R
<i>FullChargeCapacity()</i>	FCC	0x12 / 0x13	mAh	R
<i>AverageCurrent()</i>	AI	0x14 / 0x15	mA	R
<i>TimeToEmpty()</i>	TTE	0x16 / 0x17	Minutes	R
<i>TimeToFull()</i>	TTF	0x18 / 0x19	Minutes	R
<i>StandbyCurrent()</i>	SI	0x1a / 0x1b	mA	R
<i>StandbyTimeToEmpty()</i>	STTE	0x1c / 0x1d	Minutes	R
<i>MaxLoadCurrent()</i>	MLI	0x1e / 0x1f	mA	R
<i>MaxLoadTimeToEmpty()</i>	MLTTE	0x20 / 0x21	Minutes	R
<i>AvailableEnergy()</i>	AE	0x22 / 0x23	mWhr / cWhr	R
<i>AveragePower()</i>	AP	0x24 / 0x25	mW / cW	R
<i>TTEatConstantPower()</i>	TTECP	0x26 / 0x27	Minutes	R
<i>Internal_Temp()</i>	INTTEMP	0x28 / 0x29	0.1°K	R
<i>CycleCount()</i>	CC	0x2a / 0x2b	Counts	R
<i>StateOfCharge()</i>	SOC	0x2c / 0x2d	%	R
<i>StateOfHealth()</i>	SOH	0x2e / 0x2f	% / num	R
<i>PassedCharge()</i>	PCHG	0x34 / 0x35	mAh	R
<i>DOD0()</i>	DOD0	0x36 / 0x37	HEX#	R
<i>SelfDischargeCurrent()</i>	SDSG	0x38 / 0x39	mA	R

PRODUCTPREVIEW

Control(): 0x00/0x01

Issuing a *Control()* command requires a subsequent 2-byte subcommand. These additional bytes specify the particular control function desired. The *Control()* command allows the system to control specific features of the bq27541-G1 during normal operation and additional features when the bq27541-G1 is in different access modes, as described in [Table 2](#).

Table 2. Control() Subcommands

CNTL FUNCTION	CNTL DATA	SEALED ACCESS	DESCRIPTION
CONTROL_STATUS	0x0000	Yes	Reports the status of DF Checksum, Hibernate, IT, etc.
DEVICE_TYPE	0x0001	Yes	Reports the device type of 0x0541 (indicating bq27541-G1)
FW_VERSION	0x0002	Yes	Reports the firmware version on the device type
HW_VERSION	0x0003	Yes	Reports the hardware version of the device type
Resereved	0x0004	No	Not to be used
RESET_DATA	0x0005	No	Returns reset data
Reserved	0x0006	No	Not to be used
PREV_MACWRITE	0x0007	No	Returns previous MAC command code
CHEM_ID	0x0008	Yes	Reports the chemical identifier of the Impedance Track™ configuration
BOARD_OFFSET	0x0009	No	Forces the device to measure and store the board offset
CC_OFFSET	0x000A	No	Forces the device to measure and internal CC offset
CC_OFFSET_SAVE	0x000B	No	Forces the device to store the internal CC offset
DF_VERSION	0x000C	Yes	Reports the data flash version on the device
SET_FULLSLEEP	0x0010	No	Set the <i>[FullSleep]</i> bit in Control Status register to 1
SET_HIBERNATE	0x0011	Yes	Forces CONTROL_STATUS <i>[HIBERNATE]</i> to 1
CLEAR_HIBERNATE	0x0012	Yes	Forces CONTROL_STATUS <i>[HIBERNATE]</i> to 0
SET_SHUTDOWN	0x0013	Yes	Enables the SE pin to change state
CLEAR_SHUTDOWN	0x0014	Yes	Disables the SE pin from changing state
SET_HDQINTEN	0x0015	Yes	Forces CONTROL_STATUS <i>[HDQIntEn]</i> to 1
CLEAR_HDQINTEN	0x0016	Yes	Forces CONTROL_STATUS <i>[HDQIntEn]</i> to 0
STATIC_CHEM_CHKSUM	0x0017	Yes	Calculates chemistry checksum
SEALED	0x0020	No	Places the bq27541-G1 is SEALED access mode
IT_ENABLE	0x0021	No	Enables the Impedance Track™ algorithm
CAL_ENABLE	0x002d	No	Toggle bq27541-G1 calibration mode
RESET	0x0041	No	Forces a full reset of the bq27541-G1
EXIT_CAL	0x0080	No	Exit bq27541-G1 calibration mode
ENTER_CAL	0x0081	No	Enter bq27541-G1 calibration mode
OFFSET_CAL	0x0082	No	Reports internal CC offset in calibration mode

CONTROL_STATUS: 0X0000

Instructs the fuel gauge to return status information to Control addresses 0x00/0x01. The status word includes the following information.

Table 3. CONTROL_STATUS Flags

	bit7	bit6	bit5	bit4	bit3	bit2	bit1	bit0
High Byte	SE	FAS	SS	CALMODE	CCA	BCA	CSV	HDQHOSTIN
Low Byte	SHUTDOWN	HIBERNATE	FULLSLEEP	SLEEP	LDMD	RUP_DIS	VOK	QEN

- SE = Status bit indicating the SE pin is active. True when set. Default is 0.
- FAS = Status bit indicating the bq27541-G1 is in FULL ACCESS SEALED state. Active when set.
- SS = Status bit indicating the bq27541-G1 is in the SEALED State. Active when set.
- CALMODE = Status bit indicating the calibration function is active. True when set. Default is 0.
- CCA = Status bit indicating the bq27541-G1 Coulomb Counter Calibration routine is active. The CCA routine will take place approximately 1 minute after the initialization and periodically as gauging conditions change. Active when set.
- BCA = Status bit indicating the bq27541-G1 Board Calibration routine is active. Active when set.
- CSV = Status bit indicating a valid data flash checksum has been generated. Active when set.
- HDQHOSTIN = Status bit indicating the HDQ interrupt function is active. True when set. Default is 0.
- SHUTDOWN = Control bit indicating the fuel gauge can force its SE pin low to signal an external shutdown. True when set. Default is 1 which is controlled by Pack Configuration Register.
- HIBERNATE = Status bit indicating a request for entry into HIBERNATE from SLEEP mode has been issued. True when set. Default is 0. Control bit when set will put the bq27541-G1 into the lower power state of SLEEP mode. It is not possible to monitor this bit.
- FULLSLEEP = Status bit indicating the bq27541-G1 is in FULLSLEEP mode. True when set. The state can be detected by monitoring the power used by the bq27541-G1 because any communication will automatically clear it.
- SLEEP = Status bit indicating the bq27541-G1 is in SLEEP mode. True when set.
- LDMD = Status bit indicating the bq27541-G1 Impedance Track™ algorithm using *constant-power* mode. True when set. Default is 0 (*constant-current* mode).
- RUP_DIS = Status bit indicating the bq27541-G1 Ra table updates are disabled. True when set.
- VOK = Status bit indicating cell voltages are OK for Qmax updates. True when set.
- QEN = Status bit indicating the bq27541-G1 Qmax updates are enabled. True when set.

DEVICE_TYPE: 0X0001

Instructs the fuel gauge to return the device type to addresses 0x00/0x01.

FW_VERSION: 0X0002

Instructs the fuel gauge to return the firmware version to addresses 0x00/0x01. The bq27541-G1 firmware version return is 0x0214.

HW_VERSION: 0X0003

Instructs the fuel gauge to return the hardware version to addresses 0x00/0x01. For bq27541-G1, 0x0060 is returned. For firmware upgrade from bq27541-V200, 0x0000 or 0x0060 is returned.

RESET_DATA: 0X0005

Instructs the fuel gauge to return the number of resets performed to addresses 0x00/0x01.

PREV_MACWRITE: 0X0007

Instructs the fuel gauge to return the previous command written to addresses 0x00/0x01. The value returned is limited to less than 0x0020.

CHEM_ID: 0X0008

Instructs the fuel gauge to return the chemical identifier for the Impedance Track™ configuration to addresses 0x00/0x01.

BOARD_OFFSET: 0X0009

Instructs the fuel gauge to calibration board offset. During board offset calibration the [BCA] bit is set

CC_OFFSET: 0X000A

Instructs the fuel gauge to calibration coulomb counter offset. During calibration the [CCA] bit is set

CC_OFFSET_SAVE: 0X000B

Instructs the fuel gauge to save calibration coulomb counter offset after calibration.

DF_VERSION: 0x000C

Instructs the gas gauge to return the data flash version to addresses 0x00/0x01.

SET_FULLSLEEP: 0X0010

Instructs the gas gauge to set the FullSleep bit in Control Status register to 1. This will allow the gauge to enter the FULLSLEEP power mode after the transition to SLEEP power state is detected. In FullSleep mode less power is consumed by disabling an oscillator circuit used by the communication engines. For HDQ communication one host message will be dropped. For I²C communications the first I²C message will incur a 6–8 millisecond clock stretch while the oscillator is started and stabilized. A communication to the device in FULLSLEEP will force the part back to the SLEEP mode.

SET_HIBERNATE: 0X0011

Instructs the fuel gauge to force the CONTROL_STATUS [HIBERNATE] bit to 1. This will allow the gauge to enter the HIBERNATE power mode after the transition to SLEEP power state is detected and the required conditions are met. The [HIBERNATE] bit is automatically cleared upon exiting from HIBERNATE mode.

Note: For device upgrading from bq27541-V200 firmware with HW_VERSION returns 0x0000, the HIBERNATE mode is only available in I²C mode and must be disabled when HDQ mode is used. To disable the HIBERNATE mode, the Control() subcommand SET_HIBERNATE should not be used and Hibernate Voltage and Current must be set to 0 in data flash.

CLEAR_HIBERNATE: 0X0012

Instructs the fuel gauge to force the CONTROL_STATUS [HIBERNATE] bit to 0. This will prevent the gauge from entering the HIBERNATE power mode after the transition to SLEEP power state is detected. It can also be used to force the gauge out of HIBERNATE mode.

SET_SHUTDOWN: 0x0013

Sets the CONTROL_STATUS [SHUTDOWN] bit to 1, thereby enabling the SE pin to change state. The Impedance Track algorithm controls the setting of the SE pin, depending on whether the conditions are met for fuel gauge shutdown or not.

CLEAR_SHUTDOWN: 0X0014

Disables the SE pin from changing state. The SE pin is left in a high-impedance state.

SET_HDQINTEN: 0x0015

Instructs the fuel gauge to set the CONTROL_STATUS [*HDQIntEn*] bit to 1. This will enable the HDQ Interrupt function. When this subcommand is received, the device will detect any of the interrupt conditions and assert the interrupt at one second intervals until the CLEAR_HDQINTEN command is received or the count of HDQHostIntrTries has lapsed (default 3).

CLEAR_HDQINTEN: 0x0016

Instructs the fuel gauge to set the CONTROL_STATUS [*HDQIntEn*] bit to 0. This will disable the HDQ Interrupt function.

STATIC_CHEM_DF_CHKSUM: 0x0017

Instructs the fuel gauge to calculate chemistry checksum as a 16-bit unsigned integer sum of all static chemistry data. The most significant bit (MSB) of the checksum is masked yielding a 15-bit checksum. This checksum is compared with value stored in the data flash **Static Chem DF Checksum**. If the value matches, the MSB will be cleared to indicate pass. If it does not match, the MSB will be set to indicate failure.

SEALED: 0X0020

Instructs the gas gauge to transition from UNSEALED state to SEALED state. The gas gauge should always be set to SEALED state for use in customer's end equipment.

IT ENABLE: 0X0021

This command forces the fuel gauge to begin the Impedance Track™ algorithm, sets bit 2 of **UpdateStatus** and causes the [VOK] and [QEN] flags to be set in the CONTROL_STATUS register. [VOK] is cleared if the voltages are not suitable for a Qmax update. Once set, [QEN] cannot be cleared. This command is only available when the fuel gauge is UNSEALED and is typically enabled at the last step of production after system test is completed.

RESET: 0X0041

This command instructs the gas gauge to perform a full reset. This command is only available when the gas gauge is UNSEALED.

EXIT_CAL: 0X0080

This command instructs the gas gauge to exit calibration mode.

ENTER_CAL: 0X0081

This command instructs the gas gauge to enter calibration mode.

OFFSET_CAL: 0X0082

This command instructs the gas gauge to perform offset calibration.

AtRate(): 0x02/0x03

The *AtRate()* read-/write-word function is the first half of a two-function command call-set used to set the *AtRate* value used in calculations made by the *AtRateTimeToEmpty()* function. The *AtRate()* units are in mA.

The *AtRate()* value is a signed integer, with negative values interpreted as a discharge current value. The *AtRateTimeToEmpty()* function returns the predicted operating time at the *AtRate* value of discharge. The default value for *AtRate()* is zero and will force *AtRateTimeToEmpty()* to return 65,535. Both the *AtRate()* and *AtRateTimeToEmpty()* commands should only be used in NORMAL mode.

AtRateTimeToEmpty(): 0x04/0x05

This read-only function returns an unsigned integer value of the predicted remaining operating time if the battery is discharged at the *AtRate()* value in minutes with a range of 0 to 65,534. A value of 65,535 indicates *AtRate()* = 0. The fuel gauge updates *AtRateTimeToEmpty()* within 1 s after the system sets the *AtRate()* value. The fuel gauge automatically updates *AtRateTimeToEmpty()* based on the *AtRate()* value every 1s. Both the *AtRate()* and *AtRateTimeToEmpty()* commands should only be used in NORMAL mode.

Temperature(): 0x06/0x07

This read-only function returns an unsigned integer value of the battery temperature in units of 0.1K measured by the fuel gauge.

Voltage(): 0x08/0x09

This read-only function returns an unsigned integer value of the measured cell-pack voltage in mV with a range of 0 to 6000 mV.

Flags(): 0x0a/0x0b

This read-only function returns the contents of the gas-gauge status register, depicting the current operating status.

Table 4. Flags Bit Definitions

	bit7	bit6	bit5	bit4	bit3	bit2	bit1	bit0
High Byte	OTC	OTD	BATHIGH	BATLOW	CHG_INH	RSVD	FC	CHG
Low Byte	OCVTAKEN	ISD	TDD	HW1	HW0	SOC1	SOCF	DSG

OTC = Over-Temperature in Charge condition is detected. True when set.

OTD = Over-Temperature in Discharge condition is detected. True when set.

BATHIGH = Battery High bit indicating a high battery voltage condition. Refer to the Data Flash **BATTERY HIGH** parameters for threshold settings.

BATLOW = Battery Low bit indicating a low battery voltage condition. Refer to the Data Flash **BATTERY LOW** parameters for threshold settings.

CHG_INH = Charge Inhibit indicates the temperature is outside the range [*Charge Inhibit Temp Low, Charge Inhibit Temp High*]. True when set.

RSVD = Reserved.

FC = Full-charged is detected. FC is set when charge termination is reached and *FC Set%* = -1 (See the Charging and Charge Termination Indication section for details) or State of Charge is larger than *FC Set%* and *FC Set%* is not -1. True when set.

CHG = (Fast) charging allowed. True when set.

OCVTAKEN = Cleared on entry to relax mode and set to 1 when OCV measurement is performed in relax.

ISD = Internal Short is detected. True when set.

TDD = Tab Disconnect is detected. True when set.

REV[1:0] Device Identification. Default is 01

SOC1 = State-of-Charge-Threshold 1 (**SOC1 Set**) reached. True when set.

SOCF = State-of-Charge-Threshold Final (**SOCF Set %**) reached. True when set.

DSG = Discharging detected. True when set.

NominalAvailableCapacity(): 0x0c/0x0d

This read-only command pair returns the uncompensated (less than C/20 load) battery capacity remaining. Units are mAh.

FullAvailableCapacity(): 0x0e/0x0f

This read-only command pair returns the uncompensated (less than C/20 load) capacity of the battery when fully charged. Units are mAh. *FullAvailableCapacity()* is updated at regular intervals, as specified by the IT algorithm.

RemainingCapacity(): 0x10/0x11

This read-only command pair returns the compensated battery capacity remaining. Units are mAh.

FullChargeCapacity(): 0x12/13

This read-only command pair returns the compensated capacity of the battery when fully charged. Units are mAh. *FullChargeCapacity()* is updated at regular intervals, as specified by the IT algorithm.

AverageCurrent(): 0x14/0x15

This read-only command pair returns a signed integer value that is the average current flow through the sense resistor. It is updated every 1 second. Units are mA.

TimeToEmpty(): 0x16/0x17

This read-only function returns an unsigned integer value of the predicted remaining battery life at the present rate of discharge, in minutes. A value of 65,535 indicates battery is not being discharged.

TimeToFull(): 0x18/0x19

This read-only function returns an unsigned integer value of predicted remaining time until the battery reaches full charge, in minutes, based upon *AverageCurrent()*. The computation accounts for the taper current time extension from the linear TTF computation based on a fixed *AverageCurrent()* rate of charge accumulation. A value of 65,535 indicates the battery is not being charged.

StandbyCurrent(): 0x1a/0x1b

This read-only function returns a signed integer value of the measured standby current through the sense resistor. The *StandbyCurrent()* is an adaptive measurement. Initially it reports the standby current programmed in **Initial Standby**, and after spending some time in standby, reports the measured standby current.

The register value is updated every 1 second when the measured current is above the **Deadband** and is less than or equal to 2 x **Initial Standby**. The first and last values that meet this criteria are not averaged in, since they may not be stable values. To approximate a 1 minute time constant, each new *StandbyCurrent()* value is computed by taking approximate 93% weight of the last standby current and approximate 7% of the current measured average current.

StandbyTimeToEmpty(): 0x1c/0x1d

This read-only function returns an unsigned integer value of the predicted remaining battery life at the standby rate of discharge, in minutes. The computation uses *Nominal Available Capacity* (NAC), the uncompensated remaining capacity, for this computation. A value of 65,535 indicates battery is not being discharged.

MaxLoadCurrent(): 0x1e/0x1f

This read-only function returns a signed integer value, in units of mA, of the maximum load conditions. The *MaxLoadCurrent()* is an adaptive measurement which is initially reported as the maximum load current programmed in **Initial Max Load Current**. If the measured current is ever greater than **Initial Max Load Current**, then *MaxLoadCurrent()* updates to the new current. *MaxLoadCurrent()* is reduced to the average of the previous value and **Initial Max Load Current** whenever the battery is charged to full after a previous discharge to an SOC less than 50%. This prevents the reported value from maintaining an unusually high value.

MaxLoadTimeToEmpty(): 0x20/0x21

This read-only function returns an unsigned integer value of the predicted remaining battery life at the maximum load current discharge rate, in minutes. A value of 65,535 indicates that the battery is not being discharged.

AvailableEnergy(): 0x22/0x23

This read-only function returns an unsigned integer value of the predicted charge or energy remaining in the battery. The value is reported in units of mW (**Design Energy Scale = 1**) or cW (**Design Energy Scale = 10**) .

AveragePower(): 0x24/0x25

This read-word function returns an unsigned integer value of the average power of the current discharge. It is negative during discharge and positive during charge. A value of 0 indicates that the battery is not being discharged. The value is reported in units of mW (**Design Energy Scale = 1**) or cW (**Design Energy Scale = 10**) .

TimeToEmptyAtConstantPower(): 0x26/0x27

This read-only function returns an unsigned integer value of the predicted remaining operating time if the battery is discharged at the *AveragePower()* value in minutes. A value of 65,535 indicates *AveragePower() = 0*. The fuel gauge automatically updates *TimeToEmptyatConstantPower()* based on the *AveragePower()* value every 1s.

Internal_Temp(): 0x28/0x29

This read-only function returns an unsigned integer value of the measured internal temperature of the device in units of 0.1K measured by the fuel gauge.

CycleCount(): 0x2a/0x2b

This read-only function returns an unsigned integer value of the number of cycles the battery has experienced with a range of 0 to 65,535. One cycle occurs when accumulated discharge \geq **CC Threshold**.

StateOfCharge(): 0x2c/0x2d

This read-only function returns an unsigned integer value of the predicted remaining battery capacity expressed as a percentage of *FullChargeCapacity()*, with a range of 0 to 100%.

StateOfHealth(): 0x2e/0x2f

0x2e SOH percentage: this read-only function returns an unsigned integer value, expressed as a percentage of the ratio of predicted *FCC(25°C, SOH current rate)* over the *DesignCapacity()*. The *FCC(25°C, SOH current rate)* is the calculated full charge capacity at 25°C and the SOH current rate which is specified in the data flash (State of Health Load). The range of the returned SOH percentage is 0x00 to 0x64, indicating 0 to 100% correspondingly.

PassedCharge(): 0x34/0x35

This signed integer indicates the amount of charge passed through the sense resistor since the last IT simulation in mAh.

DOD0(): 0x36/0x37

This unsigned integer indicates the depth of discharge during the most recent OCV reading.

SelfDischargeCurrent(): 0x38/0x39

This read-only command pair returns the a signed integer value that estimates the battery self discharge current.

EXTENDED DATA COMMANDS

Extended commands offer additional functionality beyond the standard set of commands. They are used in the same manner; however unlike standard commands, extended commands are not limited to 2-byte words. The number of command bytes for a given extended command ranges in size from single to multiple bytes, as specified in [Table 5](#). For details on the SEALED and UNSEALED states, see Section *Access Modes*.

Table 5. Extended Commands

NAME		COMMAND CODE	UNITS	SEALED ACCESS ⁽¹⁾ ⁽²⁾	UNSEALED ACCESS ⁽¹⁾ ⁽²⁾
Reserved	RSVD	0x38...0x39	N/A	R	R
PackConfig()	PCR	0x3a / 0x3b	HEX#	R	R
DesignCapacity()	DCAP	0x3c / 0x3d	mAh	R	R
DataFlashClass() ⁽²⁾	DFCLS	0x3e	N/A	N/A	R/W
DataFlashBlock() ⁽²⁾	DFBLK	0x3f	N/A	R/W	R/W
BlockData() / Authenticate() ⁽³⁾	A/DF	0x40...0x53	N/A	R/W	R/W
BlockData() / AuthenticateChecksum() ⁽³⁾	ACKS/DFD	0x54	N/A	R/W	R/W
BlockData()	DFD	0x55...0x5f	N/A	R	R/W
BlockDataChecksum()	DFDCKS	0x60	N/A	R/W	R/W
BlockDataControl()	DFDCNTL	0x61	N/A	N/A	R/W
DeviceNameLength()	DNAMELEN	0x62	N/A	R	R
DeviceName()	DNAME	0x63...0x6c	N/A	R	R
Reserved	RSVD	0x6d...0x7f	N/A	R	R

(1) SEALED and UNSEALED states are entered via commands to **Control()** 0x00/0x01

(2) In SEALED mode, data flash CANNOT be accessed through commands 0x3e and 0x3f.

(3) The BlockData() command area shares functionality for accessing general data flash and for using Authentication. See section on Authentication for more details.

PackConfig(): 0x3a/0x3b

SEALED and UNSEALED Access: This command returns the value is stored in **Pack Configuration** and is expressed in hex value.

DesignCapacity(): 0x3c/0x3d

SEALED and UNSEALED Access: This command returns the value is stored in **Design Capacity** and is expressed in mAh. This is intended to be the theoretical or nominal capacity of a new pack, but has no bearing on the operation of the fuel gauge functionality.

DataFlashClass(): 0x3e

This command sets the data flash class to be accessed. The class to be accessed should be entered in hexadecimal.

SEALED Access: This command is not available in SEALED mode.

DataFlashBlock(): 0x3f

UNSEALED Access: This command sets the data flash block to be accessed. When 0x00 is written to **BlockDataControl()**, **DataFlashBlock()** holds the block number of the data flash to be read or written. Example: writing a 0x00 to **DataFlashBlock()** specifies access to the first 32 byte block and a 0x01 specifies access to the second 32 byte block, and so on.

SEALED Access: This command directs which data flash block will be accessed by the **BlockData()** command. Writing a 0x00 to **DataFlashBlock()** specifies the **BlockData()** command will transfer authentication data. Issuing a 0x01, 0x02 or 0x03 instructs the **BlockData()** command to transfer **Manufacturer Info Block A or B** respectively.

BlockData(): 0x40...0x5f

This command range is used to transfer data for data flash class access. This command range is the 32-byte data block used to access **Manufacturer Info Block A or B**. **Manufacturer Info Block A** is read only for the sealed access. UNSEALED access is read/write.

BlockDataChecksum(): 0x60

The host system should write this value to inform the device that new data is ready for programming into the specified data flash class and block.

UNSEALED Access: This byte contains the checksum on the 32 bytes of block data read or written to data flash. The least-significant byte of the sum of the data bytes written must be complemented ($[255 - x]$, for x the 8-bit summation of the BlockData() (0x40 to 0x5F) on a byte-by-byte basis.) before being written to 0x60.

SEALED Access: This byte contains the checksum for the 32 bytes of block data written to **Manufacturer Info Block A or B**. The least-significant byte of the sum of the data bytes written must be complemented ($[255 - x]$, for x the 8-bit summation of the BlockData() (0x40 to 0x5F) on a byte-by-byte basis.) before being written to 0x60.

BlockDataControl(): 0x61

UNSEALED Access: This command is used to control data flash access mode. The value determines the the data flash to be accessed. Writing 0x00 to this command enables *BlockData()* to access general data flash.

SEALED Access: This command is not available in SEALED mode.

DeviceNameLength(): 0x62

UNSEALED and SEALED Access: This byte contains the length of the **Device Name**.

DeviceName(): 0x63...0x6c

UNSEALED and SEALED Access: This block contains the device name that is programmed in **Device Name**.

Reserved – 0x6a – 0x7f

DATA FLASH INTERFACE

ACCESSING THE DATA FLASH

The bq27541-G1 data flash is a non-volatile memory that contains initialization, default, cell status, calibration, configuration, and user information. The data flash can be accessed in several different ways, depending on what mode the bq27541-G1 is operating in and what data is being accessed.

Commonly accessed data flash memory locations, frequently read by a system, are conveniently accessed through specific instructions, already described in Section *Data Commands*. These commands are available when the bq27541-G1 is either in UNSEALED or SEALED modes.

Most data flash locations, however, are only accessible in UNSEALED mode by use of the bq27541-G1 evaluation software or by data flash block transfers. These locations should be optimized and/or fixed during the development and manufacture processes. They become part of a golden image file and can then be written to multiple battery packs. Once established, the values generally remain unchanged during end-equipment operation.

To access data flash locations individually, the block containing the desired data flash location(s) must be transferred to the command register locations, where they can be read to the system or changed directly. This is accomplished by sending the set-up command *BlockDataControl()* (0x61) with data 0x00. Up to 32 bytes of data can be read directly from the BlockData() (0x40...0x5f), externally altered, then rewritten to the *BlockData()* command space. Alternatively, specific locations can be read, altered, and rewritten if their corresponding offsets are used to index into the *BlockData()* command space. Finally, the data residing in the command space is transferred to data flash, once the correct checksum for the whole block is written to *BlockDataChecksum()* (0x60).

Occasionally, a data flash CLASS will be larger than the 32-byte block size. In this case, the *DataFlashBlock()* command is used to designate which 32-byte block the desired locations reside in. The correct command address is then given by $0x40 + \text{offset modulo } 32$. For example, to access **Terminate Voltage** in the *Gas Gauging* class, *DataFlashClass()* is issued 80 (0x50) to set the class. Because the offset is 67, it must reside in the third 32-byte block. Hence, *DataFlashBlock()* is issued 0x02 to set the block offset, and the offset used to index into the *BlockData()* memory area is $0x40 + 67 \text{ modulo } 32 = 0x40 + 16 = 0x40 + 0x03 = 0x43$.

Reading and writing subclass data are block operations up to 32 bytes in length. If during a write the data length exceeds the maximum block size, then the data is ignored.

None of the data written to memory are bounded by the bq27541-G1 — the values are not rejected by the fuel gauge. Writing an incorrect value may result in hardware failure due to firmware program interpretation of the invalid data. The written data is persistent, so a power-on reset does not resolve the fault.

MANUFACTURER INFORMATION BLOCKS

The bq27541-G1 contains 64 bytes of user programmable data flash storage: **Manufacturer Info Block A** and **Manufacturer Info Block B**. The method for accessing these memory locations is slightly different, depending on whether the device is in UNSEALED or SEALED modes.

When in UNSEALED mode and when 0x00 has been written to *BlockDataControl()*, accessing the Manufacturer Info Blocks is identical to accessing general data flash locations. First, a *DataFlashClass()* command is used to set the subclass, then a *DataFlashBlock()* command sets the offset for the first data flash address within the subclass. The *BlockData()* command codes contain the referenced data flash data. When writing the data flash, a checksum is expected to be received by *BlockDataChecksum()*. Only when the checksum is received and verified is the data actually written to data flash.

As an example, the data flash location for **Manufacturer Info Block B** is defined as having a Subclass = 58 and an Offset = 32 through 63 (32 byte block). The specification of Class = System Data is not needed to address **Manufacturer Info Block B**, but is used instead for grouping purposes when viewing data flash info in the bq27541-G1 evaluation software.

When in SEALED mode or when 0x01 *BlockDataControl()* does not contain 0x00, data flash is no longer available in the manner used in UNSEALED mode. Rather than issuing subclass information, a designated Manufacturer Information Block is selected with the *DataFlashBlock()* command. Issuing a 0x01, 0x02, or 0x03 with this command causes the corresponding information block (A, B, or C, respectively) to be transferred to the command space 0x40...0x5f for editing or reading by the system. Upon successful writing of checksum information to *BlockDataChecksum()*, the modified block is returned to data flash. **Note: Manufacturer Info Block A** is read-only when in SEALED mode.

ACCESS MODES

The bq27541-G1 provides three security modes (FULL ACCESS, UNSEALED, and SEALED) that control data flash access permissions according to [Table 6](#). *Data Flash* refers to those data flash locations, specified in [Table 7](#), that are accessible to the user. *Manufacture Information* refers to the three 32-byte blocks.

Table 6. Data Flash Access

SECURITY MODE	DATA FLASH	MANUFACTURER INFORMATION
FULL ACCESS	R/W	R/W
UNSEALED	R/W	R/W
SEALED	None	R (A); R/W (B,C)

Although FULL ACCESS and UNSEALED modes appear identical, only FULL ACCESS mode allows the bq27541-G1 to write access-mode transition keys.

SEALING/UNSEALING DATA FLASH

The bq27541-G1 implements a key-access scheme to transition between SEALED, UNSEALED, and FULL-ACCESS modes. Each transition requires that a unique set of two keys be sent to the bq27541-G1 via the *Control()* control command. The keys must be sent consecutively, with no other data being written to the *Control()* register in between. Note that to avoid conflict, the keys must be different from the codes presented in the *CNTL DATA* column of [Table 2](#) subcommands.

When in SEALED mode the [SS] bit of CONTROL_STATUS is set, but when the UNSEAL keys are correctly received by the bq27541-G1, the [SS] bit is cleared. When the full-access keys are correctly received the CONTROL_STATUS [FAS] bit is cleared.

Both **Unseal Key** and **Full-Access Key** have two words and are stored in data flash. The first word is Key 0 and the second word is Key 1. The order of the keys sent to bq27541-G1 are Key 1 followed by Key 0. The order of the bytes for each key entered through the *Control()* command is the reverse of what is read from the part. For an example, if the Unseal Key is 0x56781234, key 1 is 0x1234 and key 0 is 0x5678. Then *Control()* should supply 0x3412 and 0x7856 to unseal the part. The **Unseal Key** and the **Full-Access Key** can only be updated when in FULL-ACCESS mode.

DATA FLASH SUMMARY

Table 7 summarizes the data flash locations available to the user, including their default, minimum, and maximum values.

Table 7. Data Flash Summary

Class	Subclass ID	Subclass	Offset	Name	Data Type	Min Value	Max Value	Default Value	Units (EVSU Units)*
Configuration	2	Safety	0	OT Chg	I2	0	1200	550	0.1°C
Configuration	2	Safety	2	OT Chg Time	U1	0	60	2	s
Configuration	2	Safety	3	OT Chg Recovery	I2	0	1200	500	0.1°C
Configuration	2	Safety	5	OT Dsg	I2	0	1200	600	0.1°C
Configuration	2	Safety	7	OT Dsg Time	U1	0	60	2	s
Configuration	2	Safety	8	OT Dsg Recovery	I2	0	1200	550	0.1°C
Configuration	32	Charge Inhibit Cfg	0	Chg Inhibit Temp Low	I2	-400	1200	0	0.1°C
Configuration	32	Charge Inhibit Cfg	2	Chg Inhibit Temp High	I2	-400	1200	450	0.1°C
Configuration	32	Charge Inhibit Cfg	4	Temp Hys	I2	0	100	50	0.1°C
Configuration	34	Charge	0	Charging Voltage	I2	0	4600	4200	mV
Configuration	36	Charge Termination	0	Taper Current	I2	0	1000	100	mA
Configuration	36	Charge Termination	2	Min Taper Capacity	I2	0	1000	25	mAh
Configuration	36	Charge Termination	4	Taper Voltage	I2	0	1000	100	mV
Configuration	36	Charge Termination	6	Current Taper Window	U1	0	60	40	s
Configuration	36	Charge Termination	7	TCA Set %	I1	-1	100	99	%
Configuration	36	Charge Termination	8	TCA Clear %	I1	-1	100	95	%
Configuration	36	Charge Termination	9	FC Set %	I1	-1	100	100	%
Configuration	36	Charge Termination	10	FC Clear %	I1	-1	100	98	%
Configuration	36	Charge Termination	11	DODatEOC Delta T	I2	0	1000	100	0.1°C
Configuration	48	Data	0	Rem Cap Alarm	I2	0	700	100	mA
Configuration	48	Data	8	Initial Standby	I1	-256	0	-10	mA
Configuration	48	Data	9	Initial MaxLoad	I2	-32767	0	-500	mA
Configuration	48	Data	17	Cycle Count	U2	0	65535	0	num
Configuration	48	Data	19	CC Threshold	I2	100	32767	900	mAh
Configuration	48	Data	23	Design Capacity	I2	0	32767	1000	mA
Configuration	48	Data	25	Design Energy	I2	0	32767	5400	mWh/cWh
Configuration	48	Data	27	SOH Load I	I2	-32767	0	-400	mA
Configuration	48	Data	29	TDD SOH Percent	I1	0	100	90	%
Configuration	48	Data	40	ISD Current	I2	0	32767	10	HourRate
Configuration	48	Data	42	ISD I Filter	U1	0	255	127	num
Configuration	48	Data	43	Min ISD Time	U1	0	255	7	Hour
Configuration	48	Data	44	Design Energy Scale	U1	0	255	1	num
Configuration	48	Data	45	Device Name	S11	x	x	bq27541	-
Configuration	49	Discharge	0	SOC1 Set Threshold	U2	0	65535	150	mAh
Configuration	49	Discharge	2	SOC1 Clear Threshold	U2	0	65535	175	mAh
Configuration	49	Discharge	4	SOCF Set Threshold	U2	0	65535	75	mAh
Configuration	49	Discharge	6	SOCF Clear Threshold	U2	0	65535	100	mAh
Configuration	49	Discharge	9	BL Set Volt Threshold	I2	0	16800	0	mV
Configuration	49	Discharge	11	BL Set Volt Time	U1	0	60	0	s
Configuration	49	Discharge	12	BL Clear Volt Threshold	I2	0000	16800	5	mV
Configuration	49	Discharge	14	BH Set Volt Threshold	I2	0	16800	4300	mV
Configuration	49	Discharge	16	BH Volt Time	U1	0	60	2	s
Configuration	49	Discharge	17	BH Clear Volt Threshold	I2	0000	16800	5	mV
Configuration	56	Manufacturer Data	0	Pack Lot Code	H2	0x0	0xffff	0x0	-
Configuration	56	Manufacturer Data	2	PCB Lot Code	H2	0x0	0xffff	0x0	-
Configuration	56	Manufacturer Data	4	Firmware Version	H2	0x0	0xffff	0x0	-
Configuration	56	Manufacturer Data	6	Hardware Revision	H2	0x0	0xffff	0x0	-
Configuration	56	Manufacturer Data	8	Cell Revision	H2	0x0	0xffff	0x0	-
Configuration	56	Manufacturer Data	10	DF Config Version	H2	0x0	0xffff	0x0	-
Configuration	57	Integrity Data	6	Static Chem DF Checksum	H2	0x0	0x7fff	0x0	-

Table 7. Data Flash Summary (continued)

Class	Subclass ID	Subclass	Offset	Name	Data Type	Min Value	Max Value	Default Value	Units (EVSU Units)*
Configuration	59	Lifetime Data	0	Lifetime Max Temp	I2	0	1400	300	0.1°C
Configuration	59	Lifetime Data	2	Lifetime Min Temp	I2	-600	1400	200	0.1°C
Configuration	59	Lifetime Data	4	Lifetime Max Pack Voltage	I2	0	32767	3200	mV
Configuration	59	Lifetime Data	6	Lifetime Min Pack Voltage	I2	0	32767	3500	mV
Configuration	59	Lifetime Data	8	Lifetime Max Chg Current	I2	-32767	32767	0	mA
Configuration	59	Lifetime Data	10	Lifetime Max Dsg Current	I2	-32767	32767	0	mA
Configuration	60	Lifetime Temp Samples	0	LT Flash Cnt	U2	0	65535	0	-
Configuration	64	Registers	0	Pack Configuration	H2	0x0	0xffff	0x0177	-
Configuration	64	Registers	2	Pack Configuration B	H1	0x0	0xff	0x1f	-
Configuration	64	Registers	3	Pack Configuration C	H1	0x0	0xff	0x0	-
Configuration	66	Lifetime Resolution	0	LT Temp Res	U1	0	255	10	Num
Configuration	66	Lifetime Resolution	1	LT V Res	U1	0	255	25	Num
Configuration	66	Lifetime Resolution	2	LT Cur Res	U1	0	255	100	Num
Configuration	66	Lifetime Resolution	3	LT Update Time	U2	0	65535	60	Num
Configuration	68	Power	0	Flash Update OK Voltage	I2	0	4200	2800	mV
Configuration	68	Power	2	Sleep Current	I2	0	100	10	mA
Configuration	68	Power	11	Hibernate I	U2	0	700	8	mA
Configuration	68	Power	13	Hibernate V	U2	2400	3000	2550	mV
Configuration	68	Power	15	FS Wait	U1	0	255	0	s
System Data	58	Manufacturer Info	0 - 31	Block A 0 - 31	H1	0x0	0xff	0x0	-
System Data	58	Manufacturer Info	32 - 63	Block B 0 - 31	H1	0x0	0xff	0x0	-
Gas Gauging	80	IT Cfg	0	Load Select	U1	0	255	1	-
Gas Gauging	80	IT Cfg	1	Load Mode	U1	0	255	0	-
Gas Gauging	80	IT Cfg	21	Max Res Factor	U1	0	255	15	num
Gas Gauging	80	IT Cfg	22	Min Res Factor	U1	0	255	3	num
Gas Gauging	80	IT Cfg	25	Ra Filter	U2	0	1000	500	num
Gas Gauging	80	IT Cfg	42	Fast Qmax Start DOD %	U1	0	255	92	%
Gas Gauging	80	IT Cfg	43	Fast Qmax End DOD %	U1	0	255	96	%
Gas Gauging	80	IT Cfg	44	Fast Qmax Start Volt Delta	I2	0	4200	200	mV
Gas Gauging	80	IT Cfg	67	Terminate Voltage	I2	2800	3700	3000	mV
Gas Gauging	80	IT Cfg	69	Term V Delta	I2	0	4200	200	mV
Gas Gauging	80	IT Cfg	72	ResRelax Time	U2	0	65534	200	s
Gas Gauging	80	IT Cfg	76	User Rate-mA	I2	2000	9000	0	mA
Gas Gauging	80	IT Cfg	78	User Rate-Pwr	I2	3000	14000	0	mW/cW
Gas Gauging	80	IT Cfg	80	Reserve Cap-mAh	I2	0	9000	0	mA
Gas Gauging	80	IT Cfg	82	Reserve Energy	I2	0	14000	0	mWh/cWh
Gas Gauging	80	IT Cfg	86	Max Scale Back Grid	U1	0	15	4	-
Gas Gauging	80	IT Cfg	87	Max DeltaV	U2	0	65535	200	mV
Gas Gauging	80	IT Cfg	89	Min DeltaV	U2	0	65535	0	mV
Gas Gauging	80	IT Cfg	91	Max Sim Rate	U1	0	255	2	C/rate
Gas Gauging	80	IT Cfg	92	Min Sim Rate	U1	0	255	20	C/rate
Gas Gauging	80	IT Cfg	93	Ra Max Delta	U2	0	65535	44	mΩ
Gas Gauging	80	IT Cfg	95	Qmax Max Delta %	U1	0	100	5	mAh
Gas Gauging	80	IT Cfg	96	DeltaV Max Delta	U2	0	65535	10	mV
Gas Gauging	80	IT Cfg	102	Fast Scale Start SOC	U1	0	100	10	%
Gas Gauging	81	Current Thresholds	0	Dsg Current Threshold	I2	0	2000	60	mA
Gas Gauging	81	Current Thresholds	2	Chg Current Threshold	I2	0	2000	75	mA
Gas Gauging	81	Current Thresholds	4	Quit Current	I2	0	1000	40	mA
Gas Gauging	81	Current Thresholds	6	Dsg Relax Time	U2	0	8191	60	s
Gas Gauging	81	Current Thresholds	8	Chg Relax Time	U1	0	255	60	s
Gas Gauging	81	Current Thresholds	9	Quit Relax Time	U1	0	63	1	s
Gas Gauging	81	Current Thresholds	10	Max IR Correct	U2	0	1000	400	mV
Gas Gauging	82	State	0	Qmax Cell 0	I2	0	32767	1000	mAh
Gas Gauging	82	State	2	Cycle Count	U2	0	65535	0	num
Gas Gauging	82	State	4	Update Status	H1	0x0	0x6	0x0	-

Table 7. Data Flash Summary (continued)

Class	Subclass ID	Subclass	Offset	Name	Data Type	Min Value	Max Value	Default Value	Units (EVSU Units)*
Gas Gauging	82	State	5	V at Chg Term	I2	0	5000	4200	mV
Gas Gauging	82	State	7	Avg I Last Run	I2	-32768	32767	-299	mA
Gas Gauging	82	State	9	Avg P Last Run	I2	-32768	32767	-1131	mA
Gas Gauging	82	State	11	Delta Voltage	I2	-32768	32767	2	mV
Gas Gauging	82	State	15	T Rise	I2	0	32767	0	Num
Gas Gauging	82	State	17	T Time Constant	I2	0	32767	32767	Num
OCV Table	83	OCVa Table	0	Chem ID	H2	0x0	0xffff	0x0107	-
Ra Table	88	R_a0	0	Cell0 R_a flag	H2	0x0	0x0	0xff55	-
Ra Table	88	R_a0	2 - 30	Cell0 R_a 0 - 14	I2	183	183	105	2 ⁻¹⁰ Ω
Ra Table	89	R_a0x	0	xCell0 R_a flag	H2	0xffff	0xffff	0xffff	-
Ra Table	89	R_a0x	2 - 30	xCell0 R_a 0 - 14	I2	183	183	105	2 ⁻¹⁰ Ω
Calibration	104	Data	0	CC Gain	F4	1.0e-1	4.0e+1	0.4768	num
Calibration	104	Data	4	CC Delta	F4	2.9826e+4	1.193046e+6	5677445.6	num
Calibration	104	Data	8	CC Offset	I2	-32768	32767	-1200	num
Calibration	104	Data	10	Board Offset	I1	-128	127	0	num
Calibration	104	Data	11	Int Temp Offset	I1	-128	127	0	num
Calibration	104	Data	12	Ext Temp Offset	I1	-128	127	0	num
Calibration	104	Data	13	Pack V Offset	I1	-128	127	0	mV
Calibration	107	Current	1	Deadband	U1	0	255	5	mA
Security	112	Codes	0	Sealed to Unsealed	H4	0x0	0xffffffff	0x36720414	-
Security	112	Codes	4	Unsealed to Full	H4	0x0	0xffffffff	0xffffffff	-
Security	112	Codes	8	Authen Key3	H4	0x0	0xffffffff	0x01234567	-
Security	112	Codes	12	Authen Key2	H4	0x0	0xffffffff	0x89abcdef	-
Security	112	Codes	16	Authen Key1	H4	0x0	0xffffffff	0xfedcba98	-
Security	112	Codes	20	Authen Key0	H4	0x0	0xffffffff	0x76543210	-

Table 8. Data Flash to EVSW Conversion

Class	SubClass ID	SubClass	Offset	Name	Data Type	Data Flash Default	Data Flash Unit	EVSU Default	EVSU Unit	Data Flash (DF) to EVSW Conversion
Gas Gauging	80	IT Cfg	59	User Rate-mW/cW	I2	0	cW/10W	0	mW/cW	DF × 10
Gas Gauging	80	IT Cfg	63	Reserve Cap-mWh/cWh	I2	0	cWh/10cWh	0	mWh/cW	DF × 10
Calibration	104	Data	0	CC Gain	F4	0.47095	Num	10.124	mΩ	4.768/DF
Calibration	104	Data	4	CC Delta	F4	5.595e5	Num	10.147	mΩ	5677445/DF
Calibration	104	Data	8	CC Offset	I2	-1200	Num	-0.576	mV	DF × 0.00048
Calibration	104	Data	10	Board Offset	I1	0	Num	0	μV	DF × 16/0.48

PRODUCTPREVIEW

FUNCTIONAL DESCRIPTION

FUEL GAUGING

The bq27541-G1 measures the cell voltage, temperature, and current to determine battery SOC based on Impedance Track™ algorithm (Please refer to Application Report SLUA450 "Theory and Implementation of Impedance Track Battery Fuel-Gauging Algorithm" for more information). The bq27541-G1 monitors charge and discharge activity by sensing the voltage across a small-value resistor (5 mΩ to 20 mΩ typ.) between the SRP and SRN pins and in series with the cell. By integrating charge passing through the battery, the battery's SOC is adjusted during battery charge or discharge.

The total battery capacity is found by comparing states of charge before and after applying the load with the amount of charge passed. When an application load is applied, the impedance of the cell is measured by comparing the OCV obtained from a predefined function for present SOC with the measured voltage under load. Measurements of OCV and charge integration determine chemical state of charge and chemical capacity (Qmax). The initial Qmax values are taken from a cell manufacturers' data sheet multiplied by the number of parallel cells. It is also used for the value in **Design Capacity**. The bq27541-G1 acquires and updates the battery-impedance profile during normal battery usage. It uses this profile, along with SOC and the Qmax value, to determine *FullChargeCapacity()* and *StateOfCharge()*, specifically for the present load and temperature. *FullChargeCapacity()* is reported as capacity available from a fully charged battery under the present load and temperature until *Voltage()* reaches the **Terminate Voltage**. *NominalAvailableCapacity()* and *FullAvailableCapacity()* are the uncompensated (no or light load) versions of *RemainingCapacity()* and *FullChargeCapacity()* respectively.

The bq27541-G1 has two flags accessed by the *Flags()* function that warns when the battery's SOC has fallen to critical levels. When *RemainingCapacity()* falls below the first capacity threshold, specified in **SOC1 Set Threshold**, the *[SOC1] (State of Charge Initial)* flag is set. The flag is cleared once *RemainingCapacity()* rises above **SOC1 Clear Threshold**. All units are in mAh.

When *RemainingCapacity()* falls below the second capacity threshold, **SOCF Set Threshold**, the *[SOCF] (State of Charge Final)* flag is set, serving as a final discharge warning. If **SOCF Set Threshold** = -1, the flag is inoperative during discharge. Similarly, when *RemainingCapacity()* rises above **SOCF Clear Threshold** and the *[SOCF] flag* has already been set, the *[SOCF] flag* is cleared. All units are in mAh.

The bq27541-G1 has two additional flags accessed by the *Flags()* function that warns of internal battery conditions. The fuel gauge monitors the cell voltage during relaxed conditions to determine if an internal short has been detected. When this condition occurs, *[ISD]* will be set. The bq27541-G1 also has the capability of detecting when a tab has been disconnected in a 2-cell parallel system by actively monitoring the *SOH*. When this condition occurs, *[TDD]* will be set.

IMPEDANCE TRACK™ VARIABLES

The bq27541-G1 has several data flash variables that permit the user to customize the Impedance Track™ algorithm for optimized performance. These variables are dependent upon the power characteristics of the application as well as the cell itself.

Load Mode

Load Mode is used to select either the constant-current or constant-power model for the Impedance Track™ algorithm as used in **Load Select** (see **Load Select**). When **Load Mode** is 0, the *Constant Current Model* is used (default). When **Load Mode** is 1, the *Constant Power Model* is used. The *[LDMD]* bit of *CONTROL_STATUS* reflects the status of **Load Mode**.

Load Select

Load Select defines the type of power or current model to be used to compute load-compensated capacity in the Impedance Track™ algorithm. If **Load Mode** = 0 (*Constant Current*), then the options presented in [Table 9](#) are available.

Table 9. Constant-Current Model Used when Load Mode = 0

LoadSelect Value	Current Model Used
0	Average discharge current from previous cycle: There is an internal register that records the average discharge current through each entire discharge cycle. The previous average is stored in this register.
1 (default)	Present average discharge current: This is the average discharge current from the beginning of this discharge cycle until present time.
2	Average current: based off the AverageCurrent()
3	Current: based off of a low-pass-filtered version of AverageCurrent() ($\tau = 14s$)
4	Design capacity / 5: C Rate based off of Design Capacity /5 or a C / 5 rate in mA.
5	Use the value specific by AtRate()
6	Use the value in User_Rate-mA : This gives a completely user-configurable method.

If **Load Mode = 1** (*Constant Power*) then the following options are available:

Table 10. Constant-Power Model Used When Load Mode = 1

LoadSelect Value	Power Model Used
0 (default)	Average discharge power from previous cycle: There is an internal register that records the average discharge power through each entire discharge cycle. The previous average is stored in this register.
1	Present average discharge power: This is the average discharge power from the beginning of this discharge cycle until present time.
2	Average current \times voltage: based off the AverageCurrent() and Voltage() .
3	Current \times voltage: based off of a low-pass-filtered version of AverageCurrent() ($\tau = 14s$) and Voltage()
4	Design energy / 5: C Rate based off of Design Energy /5 or a C / 5 rate in mA .
5	Use the value specific by AtRate()
6	Use the value in User_Rate-mW/cW . This gives a completely user- configurable method.

Reserve Cap-mAh

Reserve Cap-mAh determines how much actual remaining capacity exists after reaching 0 **RemainingCapacity()**, before **Terminate Voltage** is reached. A loaded rate or no-load rate of compensation can be selected for **Reserve Cap** by setting [RESCAP] bit in **Pack Configuration Register**.

Reserve Cap-mWh/cWh

Reserve Cap-mWh determines how much actual remaining capacity exists after reaching 0 **AvailableEnergy()**, before **Terminate Voltage** is reached. A loaded rate or no-load rate of compensation can be selected for **Reserve Cap** by setting [RESCAP] bit in **Pack Configuration Register**.

Design Energy Scale

Design Energy Scale is used to select the scale/unit of a set of data flash parameters. The value of **Design Energy Scale** can be either 1 or 10 only.

Table 11. Data Flash Parameter scale/unit based on Design Energy Scale

Data Flash	Design Energy Scale = 1 (default)	Design Energy Scale = 10
Design Energy	mWh	cWh
Reserve Capacity -mWh/cWh	mWh	cWh
Avg Power Last Run	mW	cW
User Rate-mW/cW	mWh	cWh
T Rise	No Scale	Scaled by x10

Dsg Current Threshold

This register is used as a threshold by many functions in the bq27541-G1 to determine if actual discharge current is flowing into or out of the cell. The default for this register should be sufficient for most applications. This threshold should be set low enough to be below any normal application load current but high enough to prevent noise or drift from affecting the measurement.

Chg Current Threshold

This register is used as a threshold by many functions in the bq27541-G1 to determine if actual charge current is flowing into or out of the cell. The default for this register should be sufficient for most applications. This threshold should be set low enough to be below any normal charge current but high enough to prevent noise or drift from affecting the measurement.

Quit Current, Dsg Relax Time, Chg Relax Time, and Quit Relax Time

The **Quit Current** is used as part of the Impedance Track™ algorithm to determine when the bq27541-G1 enters relaxation mode from a current flowing mode in either the charge direction or the discharge direction. The value of Quit Current is set to a default value that should be above the standby current of the system.

Either of the following criteria must be met to enter relaxation mode:

1. $|AverageCurrent()| < |Quit\ Current|$ for **Dsg Relax Time**.
2. $|AverageCurrent()| < |Quit\ Current|$ for **Chg Relax Time**.

After about 6 minutes in relaxation mode, the bq27541-G1 attempts to take accurate OCV readings. An additional requirement of $dV/dt < 4\ \mu V/sec$ is required for the bq27541-G1 to perform Qmax updates. These updates are used in the Impedance Track™ algorithms. It is critical that the battery voltage be relaxed during OCV readings and that the current is not higher than C/20 when attempting to go into relaxation mode.

Quit Relax Time specifies the minimum time required for $AverageCurrent()$ to remain above the **QuitCurrent** threshold before exiting relaxation mode.

Qmax

Qmax contains the maximum chemical capacity of the active cell profiles, and is determined by comparing states of charge before and after applying the load with the amount of charge passed. They also correspond to capacity at low rate of discharge, such as C/20 rate. For high accuracy, this value is periodically updated by the bq27541-G1 during operation. Based on the battery cell capacity information, the initial value of chemical capacity should be entered in **Qmax** field. The Impedance Track™ algorithm will update this value and maintain it in the **Pack** profile.

Update Status

The **Update Status** register indicates the status of the Impedance Track algorithm.

Table 12. Update Status Definitions

UPDATE STATUS	STATUS
0x02	Qmax and Ra data are learned, but Impedance Track™ is not enabled. This should be the standard setting for a golden image.
0x04	Impedance Track™ is enabled but Qmax and Ra data are not learned.
0x05	Impedance Track™ is enabled and only Qmax has been updated during a learning cycle.
0x06	Impedance Track™ is enabled. Qmax and Ra data are learned after a successful learning cycle. This should be the operation setting for end equipment.

This register should only be updated by the bq27541-G1 during a learning cycle or when *IT_ENABLE()* subcommand is received. Refer to the application note *How to Generate Golden Image for Single-Cell Impedance Track™ Device (SLUA544)* for learning cycle details.

Avg I Last Run

The bq27541-G1 logs the current averaged from the beginning to the end of each discharge cycle. It stores this average current from the previous discharge cycle in this register. This register should never need to be modified. It is only updated by the bq27541-G1 when required.

Avg P Last Run

The bq27541-G1 logs the power averaged from the beginning to the end of each discharge cycle. It stores this average power from the previous discharge cycle in this register. To get a correct average power reading the bq27541-G1 continuously multiplies instantaneous current times Voltage() to get power. It then logs this data to derive the average power. This register should never need to be modified. It is only updated by the bq27541-G1 when required.

Delta Voltage

The bq27541-G1 stores the maximum difference of Voltage() during short load spikes and normal load, so the Impedance Track™ algorithm can calculate remaining capacity for pulsed loads. It is not recommended to change this value.

Ra Tables and Ra Filtering Related Parameters

These tables contain encoded data and are automatically updated during device operation. The bq27541-G1 has a filtering process to eliminate unexpected fluctuations in Ra values while the Ra values are being updated. The DF parameters RaFilter, RaMaxDelta, MaxResfactor and MinResfactor control the Filtering process of Ra values. RaMaxDelta Limits the change in Ra values to an absolute magnitude. MinResFactor and MaxResFactor parameters are cumulative filters which limit the change in Ra values to a scale on a per discharge cycle basis. These values are Data Flash configurable. No further user changes should be made to Ra values except for reading/writing the values from a prelearned pack (part of the process for creating golden image files).

MaxScaleBackGrid

MaxScaleBackGrid parameter limits the resistance grid point after which back scaling will not be performed. This variable ensures that the resistance values in the lower resistance grid points remain accurate while the battery is at a higher DoD state.

Max DeltaV, Min DeltaV

Maximal / Minimal value allowed for delta V, which will be subtracted from simulated voltage during remaining capacity simulation.

Qmax Max Delta %

Maximal change of Qmax during one update, as percentage of Design Capacity. If the gauges attempts to change Qmax exceeds this limit, changed value will be capped to old value \pm DesignCapacity*QmaxMaxDelta / 100

Fast Resistance Scaling

This new algorithm improves convergency of Remaining Capacity and terminate voltage at end of discharge. The algorithm is enabled when cell voltage goes below (Terminate Voltage + Term V Delta) or StateofCharge() goes below Fast Scale Start SOC. For most applications, the default value of Term V Delta and Fast Scale Start SOC are recommended.

Fast Qmax Update

This new algorithm improvement provides a fast Qmax update feature that can compute Qmax based on Full charge and end of discharge conditions without battery relaxation. The feature can be enabled by setting the [FASTQMAX] bit in **Operation Configuration C**. Several data flash parameters (**Fast Qmax Start DOD%**, **Fast Qmax End DOD%**, and **Fast Qmax Start Voltage Delta**) are used to configure the algorithm and default settings are recommended. Please note that Fast Qmax Update algorithm is not used during learning cycle.

DeltaV Max Delta

Maximal change of Delta V value. If attempted change of the value exceeds this limit, change value will be capped to old value \pm DeltaV Max Delta

Lifetime Data Logging Parameters

The Lifetime Data logging function helps development and diagnosis with the bq27541-G1. Note that IT_ENABLE needs to be enabled (Command 0x0021) for lifetime data logging functions to be active. bq27541-G1 logs the lifetime data as specified in the **Lifetime Data** and **Lifetime Temp Samples** data Flash Subclasses. The data log recordings are controlled by the **Lifetime Resolution** data flash Subclass.

The Lifetime Data Logging can be started by setting the IT_ENABLE bit and setting the Update Time register to a non-zero value.

Once the Lifetime Data Logging function is enabled, the measured values are compared to what is already stored in the Data Flash. If the measured value is higher than the maximum or lower than the minimum value stored in the Data Flash by more than the "Resolution" set for at least one parameter, the entire Data Flash Lifetime Registers are updated after at least LTUpdateTime.

LTUpdateTime sets the minimum update time between DF writes. When a new max/min is detected, a LT Update window of [update time] second is enabled and the DF writes occur at the end of this window. Any additional max/min value detected within this window will also be updated. The first new max/min value detected after this window will trigger the next LT Update window.

Internal to bq27541-G1, there exists a RAM max/min table in addition to the DF max/min table. The RAM table is updated independent of the resolution parameters. The DF table is updated only if at least one of the RAM parameters exceeds the DF value by more than resolution associated with it. When DF is updated, the entire RAM table is written to DF. Consequently, it is possible to see a new max/min value for a certain parameter even if the value of this parameter never exceeds the maximum or minimum value stored in the Data Flash for this parameter value by the resolution amount.

The Life Time Data Logging of one or more parameters can be reset or restarted by writing new default (or starting) values to the corresponding Data Flash registers through sealed or unsealed access as described below. However, when using unsealed access, new values will only take effect after device reset

The logged data can be accessed as R/W in unsealed mode from Lifetime Data SubClass (SubClass ID=59) of Data Flash. Lifetime data may be accessed (R/W) when sealed using a process identical Manufacturer Info Block B and C. The DataFlashBlock command code is 4. Note only the first 32 bytes of lifetime data (not resolution parameters) can be R/W when sealed. See Manufacturers Info Block section for sealed access. The logging settings such as Temperature Resolution, Voltage Resolution, Current Resolution, and Update Time can be configured only in unsealed mode by writing to the Lifetime Resolution Subclass (SubClassID=66) of the Data Flash.

The Lifetime resolution registers contain the parameters which set the limits related to how much a data parameter must exceed the previously logged Max/Min value to be updated in the lifetime log. For example, V must exceed MaxV by more than Voltage Resolution to update MaxV in the Data Flash.

DETAILED CONFIGURATION REGISTERS DESCRIPTIONS

The Pack Configuration Register

Some bq27541-G1 pins are configured via the **Pack Configuration** data flash register, as indicated in [Table 13](#). This register is programmed/read via the methods described in *Accessing the Data Flash*. The register is located at subclass = 64, offset = 0.

Table 13. Pack Configuration Bit Definition

	bit7	bit6	bit5	bit4	bit3	bit2	bit1	bit0
High Byte	RESCAP	CALEN	INTPOL	INTSEL	RSVD	IWAKE	RSNS1	RSNS0
Low Byte	GNDSEL	RESFACTSTEP	SLEEP	RMFCC	SE_PU	SE_POL	SE_EN	TEMPS

RESCAP = No-load rate of compensation is applied to the reserve capacity calculation. True when set. Default is 0.

CALEN bq27541-G1 Calibraiton mode is enabled. Default is 0.

INTPOL = Polarity for Interrupt pin. Defaults is 1.

INTSEL = Interrupt Pin select: 0 = SE Pin, 1 = HDQ pin. Default is 1.

RSVD = Reserved. Default = 0.

- IWAKE/RSNS1/RSNS0 = These bits configure the current wake function (see [Table 21](#)). Default is 0/0/1.
- GNDSEL = The ADC ground select control. The V_{SS} (Pin 6) is selected as ground reference when the bit is clear. Pin 7 is selected when the bit is set. Default is 0.
- ResFactStep = Enables Ra step up/down to Max/Min Res Factor before disabling Ra updates. Default is 1
- SLEEP = The fuel gauge can enter sleep, if operating conditions allow. True when set. Default is 1.
- RMFCC = RM is updated with the value from FCC, on valid charge termination. True when set. Default is 1.
- SE_PU = Pull-up enable for SE pin. True when set (push-pull). Default is 0.
- SE_POL = Polarity bit for SE pin. SE is active low when clear (makes SE low when gauge is ready for shutdown). Default is 1 (makes SE high when gauge is ready for shutdown).
- SE_EN = Indicates if set the shutdown feature is enabled. True when set. See the System Shutdown Enable section for details. Default is 1.
- TEMPS = Selects external thermistor for Temperature () measurements. True when set. Default is 1.

Operation Configuration B Register

Some bq27541-G1 pins are configured via the **Operation Configuration B** data flash register, as indicated in [Table 13](#). This register is programmed/read via the methods described in *Accessing the Data Flash*. The register is located at subclass = 64, offset = 2.

Table 14. Operation Configuration B Bit Definition

bit7	bit6	bit5	bit4	bit3	bit2	bit1	bit0
ChgDoDEoC	SE_TDD	VconsEN	SE_ISD	RSVD	LFPRelax	DoDWT	FConvEn

- ChgDoDEoC = Enable DoD at EoC during charging only. True when set. Default is 1. Default setting is recommended.
- SE_TDD = Enable Tab Disconnection Detection. True when set. Default is 1.
- VconsEN = Enable voltage consistency check. True when set. Default is 1. Default setting is recommended.
- SE_ISD = Enable Internal Short Detection. True when set. Default is 1.
- RSVD = Reserved. Default is 1.
- LFPRelax = Enable LiFePO4 long relaxation mode when chemical ID 400 series is selected. True when set. Default is 1.
- DoDWT = Enable Dod weighting for LiFePO4 support when chemical ID 400 series is selected. True when set. Default is 1.
- FConvEn = Enable fast convergence algorithm. Default is 1. Default setting is recommended.

Operation Configuration C Register

Some bq27541-G1 algorithm settings are configured via the **Operation Configuration C** data flash register, as indicated in [Table 13](#). This register is programmed/read via the methods described in *Accessing the Data Flash*. The register is located at subclass = 64, offset = 3.

Table 15. Operation Configuration C Bit Definition

bit7	bit6	bit5	bit4	bit3	bit2	bit1	bit0
FastQmax	RSVD	RSVD	RSVD	RSVD	RSVD	RSVD	RSVD

- FastQmax = Enable FAst Qmax Update mode. True when set. Default is 0. Default setting is recommended.
- RSVD = Reserved. Default is 0.

SYSTEM CONTROL FUNCTION

The bq27541-G1 provides system control functions which allows the fuel gauge to enter shutdown mode in order to power-off with the assistance of external circuit or provides interrupt function to the system. [Table 16](#) shows the configurations for SE and HDQ pins.

Table 16. SE and HDQ Pin Function

[INTSEL]	Communication Mode	SE Pin Function	HDQ Pin Function
0 (default)	I2C	Interrupt Mode ⁽¹⁾	Not Used
	HDQ		HDQ Mode ⁽²⁾
1	I2C	Shutdown Mode	Interrupt Mode
	HDQ		HDQ Mode ⁽²⁾

(1) [SE_EN] bit in **Pack Configuration** can be enabled to use [SE] and [SHUTDOWN] bits in CONTROL_STATUS() function; The SE pin shutdown function is disabled.

(2) HDQ pin is used for communication and HDQ Host Interrupt Feature is available

Shutdown Mode

In the shutdown mode, the SE pin is used to signal external circuit to power-off fuel gauge. This feature is useful to shutdown the fuel gauge in a deeply discharged battery to protect the battery. By default, the Shutdown Mode is in normal state. By sending SET_SHUTDOWN subcommand or setting [SE_EN] bit in **Pack Configuration** register, the [SHUTDOWN] bit is set and enables shutdown feature. When this feature is enabled and [INTSEL] is set, the SE pin can be in normal state or shutdown state. The shutdown state can be entered in HIBERNATE mode, all other power modes will default SE pin to normal state. [Table 17](#) shows the SE pin state in normal or shutdown mode. The CLEAR_SHUTDOWN subcommand or clearing [SE_EN] bit in **Pack Configuration** register can be used to disable shutdown mode.

The bq27541-G1 SE pin will be high impedance at power on reset (POR), the [SE_POL] does not affect the state of SE pin at POR. Also [SE_PU] configuration change will only take effect after POR. In addition, the [INTSEL] only controls the behavior of SE pin, it does not affect the function of [SE] and [SHUTDOWN] bits.

Table 17. SE Pin State

		Shutdown Mode [INTSEL] = 1 and ([SE_EN] or [SHUTDOWN] = 1)	
[SE_PU]	[SE_POL]	Normal state	Shutdown state
0	0	High Impedance	0
0	1	0	High Impedance
1	0	1	0
1	1	0	1

Interrupt Mode

By utilizing the interrupt mode, system can be interrupted based on detected fault conditions as specified in [Table 20](#). The SE or HDQ pin can be selected as interrupt pin by configuring [INTSEL] bit based on [Table 18](#). In addition, the pin polarity and pull-up (SE pin only) can be configured according to the system needs as described in [Table 18](#) and [Table 19](#).

Table 18. SE Pin in Interrupt Mode ([INTSEL]=0)

[SE_PU]	[INTPOL]	Interrupt Clear	Interrupt Set
0	0	High Impedance	0
0	1	0	High Impedance
1	0	1	0
1	1	0	1

Table 19. HDQ Pin in Interrupt Mode ([INTSEL]=1)

[INTPOL]	Interrupt Clear	Interrupt Set
0	High Impedance	0
1	0	High Impedance

Table 20. Interrupt Mode Fault Conditions

Interrupt Condition	Flags() status bit	Enable Condition	Comment
SOC1 Set/Clear	[SOC1]	Always	The SOC1 Set/Clear interrupt is based [SOC1] Flag condition when RemainingCapacity() reached the SOC1 Set or Clear threshold in the Data Flash.
Over Temperature Charge	[OTC]	OT Chg Time ≠ 0	The [OTC] Flag is set/clear based on conditions specified in "Over-Temperature: Charge" Section.
Over Temperature Discharge	[OTD]	OT Dsg Time ≠ 0	The [OTD] Flag is set/clear based on conditions specified in "Over-Temperature: Discharge" Section.
Battery High	[BATHIGH]	Always	The [BATHIGH] Flag is set/clear based on conditions specified in "BATTERY LEVEL INDICATION" Section.
Battery Low	[BATLOW]	Always	The [BATLOW] Flag is set/clear based on conditions specified in "BATTERY LEVEL INDICATION" Section.
Internal Short Detection	[ISD]	[SE_ISD]=1 in Pack Configuration B	The [SE_ISD] Flag is set/clear based on conditions specified in "INTERNAL SHORT DETECTION" Section
Tab disconnection detection	[TDD]	[SE_TDD]=1 in Pack Configuration B	The [TDD] Flag is set/clear based on conditions specified in "TAB DISCONNECTION DETECTION" Section

Battery Level Indication

The bq27541-G1 can indicate when battery voltage has fallen below or risen above predefined thresholds. The [BATHIGH] of Flags() is set high to indicate Voltage() is above **BH Set Volt Threshold** for predefined duration set in **BH Volt Time**. This flag returns to low once battery voltage is below or equal **BH Clear Volt threshold**. The [BATLOW] of Flags() is set high to indicate Voltage() is below **BL Set Volt Threshold** for predefined duration set in **BL Volt Time**. This flag returns to low once battery voltage is above or equal **BL Clear Volt threshold**.

The [BATHIGH] and [BATLOW] flags can be configured to control interrupt pin (SE or HDQ) by enabling interrupt mode. Refer to "Interrupt Mode" section for details.

Internal Short Detection

The bq27541-G1 can indicate detect internal battery short by setting [SE_ISD] bit in **Pack Configuraton B**. The device compares the self-discharge current calculated based StateOfCharge() in relaxation mode and AverageCurrent() measured in the system. The self-discharge rate is measured at 1 hour interval. When battery SelfDischargeCurrent() is less than the predefined **ISD Current** threshold, the [ISD] of Flags() is set high. The [ISD] of Flags() can be configured to control interrupt pin (SE or HDQ) by enabling interrupt mode. Refer to "Interrupt Mode" section for details.

Tab Disconnection Detection

The bq27541-G1 can indicate tab disconnection by detecting change of StateOfHealth(). This feature is enabled by setting [SE_TDD] bit in **Pack Configuraton B**. The [TDD] of Flags() is set when the ratio of current StateOfHealth() divided by the previous StateOfHealth() reported is less than **TDD SOH Percent**. The [TDD] of Flags() can be configured to control interrupt pin (SE or HDQ) by enabling interrupt mode. Refer to "Interrupt Mode" section for details.

TEMPERATURE MEASUREMENT AND THE TS INPUT

The bq27541-G1 measures battery temperature via the TS input in order to supply battery temperature status information to the fuel gauging algorithm and charger-control sections of the gauge. Alternatively, the gauge can also measure internal temperature via its on-chip temperature sensor, but only if the [TEMPS] bit of **Pack Configuration** register is cleared.

Regardless of which sensor is used for measurement, a system processor can request the current battery temperature by calling the Temperature() function (see *Section Standard Data Commands*, for specific information).

The thermistor circuit requires the use of an external 10kΩ thermistor with negative temperature coefficients, such as Semitec 103AT-type thermistor that connects between the Vcc and TS pins. Additional circuit information for connecting the thermistor to the bq27541 is shown in the **Reference Schematic**.

OVER-TEMPERATURE INDICATION

Over-Temperature: Charge

If during charging, $Temperature()$ reaches the threshold of **OT Chg** for a period of **OT Chg Time** and $AverageCurrent() \geq \mathbf{Chg\ Current\ Threshold}$, then the [OTC] bit of $Flags()$ is set. When $Temperature()$ falls to **OT Chg Recovery**, the [OTC] of $Flags()$ is reset.

If **OT Chg Time** = 0, the feature is disabled.

Over-Temperature: Discharge

If during discharging, $Temperature()$ reaches the threshold of **OT Dsg** for a period of **OT Dsg Time**, and $AverageCurrent() \leq \mathbf{-Dsg\ Current\ Threshold}$, then the [OTD] bit of $Flags()$ is set. When $Temperature()$ falls to **OT Dsg Recovery**, the [OTD] bit of $Flags()$ is reset.

If **OT Dsg Time** = 0, the feature is disabled.

CHARGING AND CHARGE TERMINATION INDICATION

Detection Charge Termination

For proper bq27541-G1 operation, the cell charging voltage must be specified by the user. The default value for this variable is in the data flash **Charging Voltage**.

The bq27541-G1 detects charge termination when (1) during 2 consecutive periods of Current Taper **Window**, the $AverageCurrent()$ is $< \mathbf{Taper\ Current}$, (2) during the same periods, the accumulated change in capacity $> 0.25\text{mAh} / \mathbf{Current\ Taper\ Window}$, and (3) $Voltage() > \mathbf{Charging\ Voltage - Taper\ Voltage}$. When this occurs, the [CHG] bit of $Flags()$ is cleared. Also, if the [RMFCC] bit of **Pack Configuration** is set, $RemainingCapacity()$ is set equal to $FullChargeCapacity()$. When TCA_Set is set to -1, it disables the use of the charger alarm threshold. In that case, TerminateCharge is set when the taper condition is detected. When FC_Set is set to -1, it disables the use of the full charge detection threshold. In that case, FullCharge is not set until the taper condition is met.

Charge Inhibit

The bq27541-G1 can indicate when battery temperature has fallen below or risen above predefined thresholds (**Charge Inhibit Temp Low** and **Charge Inhibit Temp High**, respectively). In this mode, the [CHG_INH] of $Flags()$ is made high to indicate this condition, and is returned to its low state, once battery temperature returns to the range [**Charge Inhibit Temp Low + Temp Hys**, **Charge Inhibit Temp High – Temp Hys**].

POWER MODES

The bq27541-G1 has three power modes: NORMAL, SLEEP, and HIBERNATE. In NORMAL mode, the bq27541-G1 is fully powered and can execute any allowable task. In SLEEP mode the fuel gauge exists in a reduced-power state, periodically taking measurements and performing calculations. Finally, in HIBERNATE mode, the fuel gauge is in a very low power state, but can be awoken by communication or certain I/O activity.

The relationship between these modes is shown in [Figure 3](#). Details are described in the sections that follow.

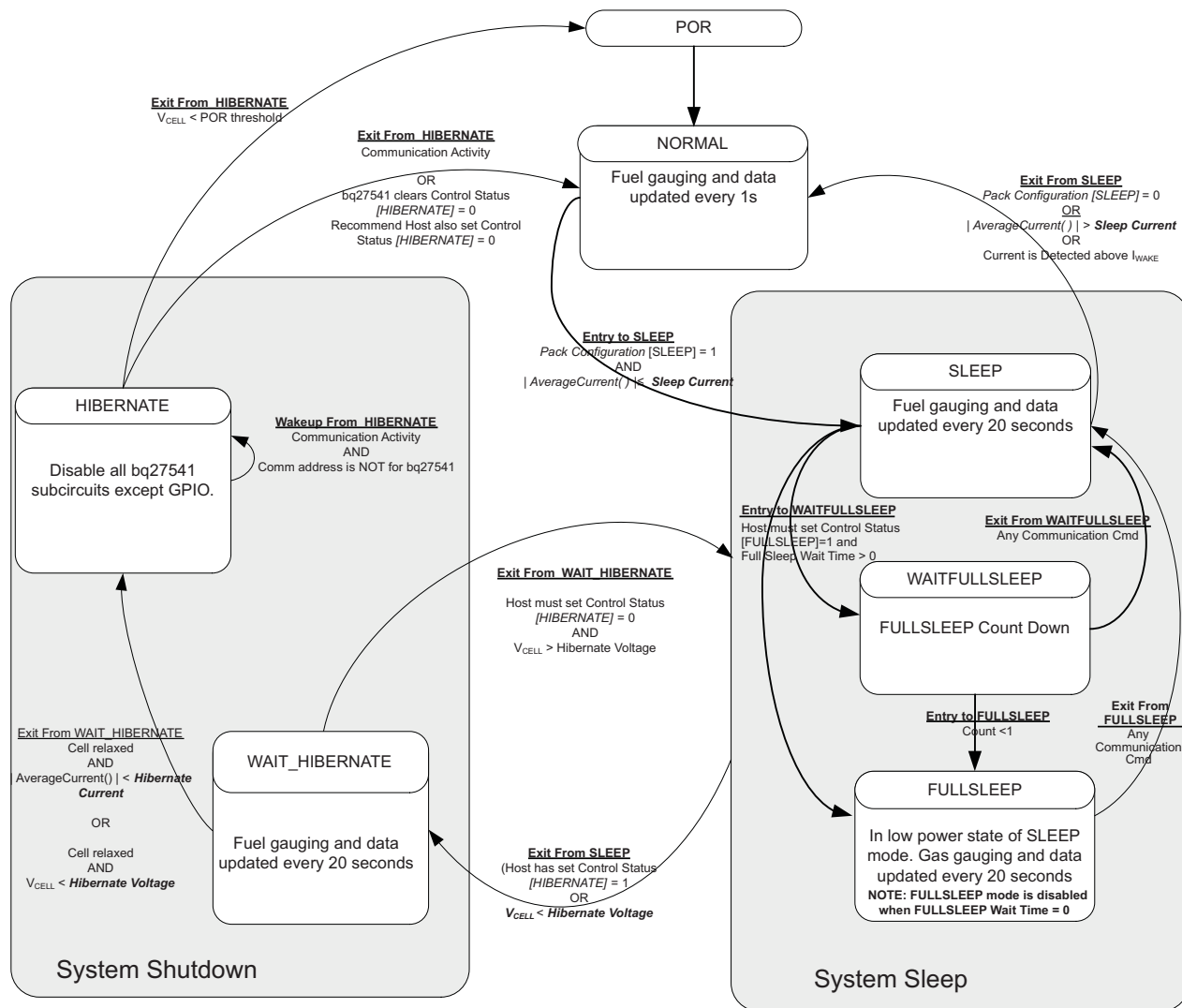

Figure 3. Power Mode Diagram

NORMAL MODE

The fuel gauge is in NORMAL Mode when not in any other power mode. During this mode, *AverageCurrent()*, *Voltage()* and *Temperature()* measurements are taken, and the interface data set is updated. Decisions to change states are also made. This mode is exited by activating a different power mode.

Because the gauge consumes the most power in NORMAL mode, the Impedance Track™ algorithm minimizes the time the fuel gauge remains in this mode.

SLEEP MODE

SLEEP mode is entered automatically if the feature is enabled (**Pack Configuration [SLEEP]** = 1) and *AverageCurrent()* is below the programmable level **Sleep Current**. Once entry into SLEEP mode has been qualified, but prior to entering it, the bq27541-G1 performs an ADC autocalibration to minimize offset.

While in SLEEP mode, the fuel gauge can suspend serial communications as much as 4ms by holding the comm line(s) low. This delay is necessary to correctly process host communication, since the fuel gauge processor is mostly halted in SLEEP mode.

During the SLEEP mode, the bq27541-G1 periodically takes data measurements and updates its data set. However, a majority of its time is spent in an idle condition.

The bq27541-G1 exits SLEEP if any entry condition is broken, specifically when (1) *AverageCurrent*() rises above **Sleep Current**, or (2) a current in excess of I_{WAKE} through R_{SENSE} is detected.

FULLSLEEP MODE

FULLSLEEP mode is enabled by setting the *Pack Configuration [FULLSLEEP]* bit in the Control Status register. FULLSLEEP mode is entered automatically when the bq27541-G1 is in SLEEP mode and the timer counts down to 0 (*Full Sleep Wait Time* > 0). FULLSLEEP mode is disabled when *Full Sleep Wait Time* is set to 0.

During FULLSLEEP mode, the bq27541-G1 periodically takes data measurements and updates its data set. However, a majority of its time is spent in an idle condition.

The gauge exits the FULLSLEEP mode when there is any communication activity. Therefore, the execution of SET_FULLSLEEP sets [FULLSLEEP] bit, but EVSW might still display the bit clear. The FULLSLEEP mode can be verified by measuring the current consumption of the gauge. In this mode, the high frequency oscillator is turned off. The power consumption is further reduced in this mode compared to the SLEEP mode.

While in FULLSLEEP mode, the fuel gauge can suspend serial communications as much as 4ms by holding the comm line(s) low. This delay is necessary to correctly process host communication, since the fuel gauge processor is mostly halted in SLEEP mode.

HIBERNATE MODE

HIBERNATE mode should be used when the host system needs to enter a low-power state, and minimal gauge power consumption is required. This mode is ideal when the host is set to its own HIBERNATE, SHUTDOWN, or OFF modes. The fuel gauge can enter HIBERNATE due to either low cell voltage or low load current.

- HIBERNATE due to the load current. If the fuel gauge enters the HIBERNATE mode due to the load current, the [HIBERNATE] bit of the CONTROL_STATUS register must be set. The gauge waits to enter HIBERNATE mode until it has taken a valid OCV measurement and the magnitude of the average cell current has fallen below Hibernate Current.
- HIBERNATE due to the cell voltage. When the cell voltage drops below the Hibernate Voltage and a valid OCV measurement has been taken, the fuel gauge enters HIBERNATE mode. The [HIBERNATE] bit of the CONTROL register has no impact for the fuel gauge to enter the HIBERNATE mode. If the [SHUTDOWN] bit of CONTROL_STATUS and [INTSEL] bit of **Pack Configuration** are set, the SE pin will be released in the state shown by [Table 16](#); thereby, allowing an optional external circuit to remove power from the gauge LDO.

The gauge will remain in HIBERNATE mode until any communication activity appears on the communication lines.

Upon exiting HIBERNATE mode, the [HIBERNATE] bit of CONTROL_STATUS is cleared. Since any communication activity wakes up the gauge from HIBERNATE mode, the host is required to set the [HIBERNATE] bit of the CONTROL_STATUS register to allow gauge to re-enter HIBERNATE mode.

Because the fuel gauge is dormant in HIBERNATE mode, the battery should not be charged or discharged in this mode, because any changes in battery charge status will not be measured. If necessary, the host equipment can draw a small current (generally infrequent and less than 1mA, for purposes of low-level monitoring and updating); however, the corresponding charge drawn from the battery will not be logged by the gauge. Once the gauge exits to NORMAL mode, the IT algorithm will take about 3 seconds to re-establish the correct battery capacity and measurements, regardless of the total charge drawn in HIBERNATE mode. During this period of re-establishment, the gauge reports previously calculated values prior to entering HIBERNATE mode. The host can identify exit from HIBERNATE mode by checking if Voltage() < Hibernate Voltage or [HIBERNATE] bit is cleared by the gauge.

If a charger is attached, the host should immediately take the fuel gauge out of HIBERNATE mode before beginning to charge the battery. Charging the battery in HIBERNATE mode will result in a notable gauging error that will take several hours to correct.

Note: For device upgrading from bq27541-V200 firmware with HW_VERSION returns 0x0000, the HIBERNATE mode is only available in I²C mode and must be disabled when HDQ mode is used. To disable the HIBERNATE mode, the Control() subcommand SET_HIBERNATE should not be used and Hibernate Voltage and Current must be set to 0 in data flash.

POWER CONTROL

Reset Functions

When the bq27541-G1 detects a software reset (*[RESET]* bit of *Control()* initiated), it determines the type of reset and increments the corresponding counter. This information is accessible by issuing the command *Control()* function with the *RESET_DATA* subcommand.

Wake-Up Comparator

The wake up comparator is used to indicate a change in cell current while the bq27541-G1 is in SLEEP modes. **Pack Configuration** uses bits *[RSNS1-RSNS0]* to set the sense resistor selection. **Operation Configuration** also uses the *[IWAKE]* bit to select one of two possible voltage threshold ranges for the given sense resistor selection. An internal interrupt is generated when the threshold is breached in either charge or discharge directions. Setting both *[RSNS1]* and *[RSNS0]* to 0 disables this feature.

Table 21. I_{WAKE} Threshold Settings⁽¹⁾

RSNS1	RSNS0	IWAKE	Vth(SRP-SRN)
0	0	0	Disabled
0	0	1	Disabled
0	1	0	+1.0 mV or –1.0 mV
0	1	1	+2.2 mV or –2.2 mV
1	0	0	+2.2 mV or –2.2 mV
1	0	1	+4.6 mV or –4.6 mV
1	1	0	+4.6 mV or –4.6 mV
1	1	1	+9.8 mV or –9.8 mV

(1) The actual resistance value vs the setting of the sense resistor is not important just the actual voltage threshold when calculating the configuration. The voltage thresholds are typical values under room temperature.

Flash Updates

Data Flash can only be updated if *Voltage()* \geq **Flash Update OK Voltage**. Flash programming current can cause an increase in LDO dropout. The value of **Flash Update OK Voltage** should be selected such that the bq27541-G1 Vcc voltage does not fall below its minimum of 2.4V during Flash write operations.

AUTOCALIBRATION

The bq27541-G1 provides an autocalibration feature that will measure the voltage offset error across SRP and SRN from time-to-time as operating conditions change. It subtracts the resulting offset error from normal sense resistor voltage, V_{SR} , for maximum measurement accuracy.

Autocalibration of the ADC begins on entry to SLEEP mode, except if *Temperature()* is $\leq 5^{\circ}\text{C}$ or *Temperature()* $\geq 45^{\circ}\text{C}$.

The fuel gauge also performs a single offset calibration when (1) the condition of *AverageCurrent()* $\leq 100\text{mA}$ and (2) {voltage change since last offset calibration $\geq 256\text{mV}$ } or {temperature change since last offset calibration is greater than 8°C for $\geq 60\text{s}$ }.

Capacity and current measurements will continue at the last measured rate during the offset calibration when these measurements cannot be performed. If the battery voltage drops more than 32mV during the offset calibration, the load current has likely increased considerably; hence, the offset calibration will be aborted.

COMMUNICATIONS

AUTHENTICATION

The bq27541-G1 can act as a SHA-1/HMAC authentication slave by using its internal engine. Sending a 160-bit SHA-1 challenge message to the bq27541-G1 will cause the gauge to return a 160-bit digest, based upon the challenge message and a hidden, 128-bit plain-text authentication key. If this digest matches an identical one generated by a host or dedicated authentication master, and when operating on the same challenge message and using the same plain text keys, the authentication process is successful.

KEY PROGRAMMING (DATA FLASH KEY)

By default, the bq27541-G1 contains a default plain-text authentication key of 0x0123456789ABCDEFEDCBA9876543210. This default key is intended for development purposes. It should be changed to a secret key and the part immediately sealed, before putting a pack into operation. Once written, a new plain-text key cannot be read again from the fuel gauge while in SEALED mode.

Once the bq27541-G1 is UNSEALED, the authentication key can be changed from its default value by writing to the *Authenticate()* Extended Data Command locations. A 0x00 is written to *BlockDataControl()* to enable the authentication data commands. The *DataFlashClass()* is issued 112 (0x70) to set the Security class. Up to 32 bytes of data can be read directly from the *BlockData()* (0x40...0x5f) and the authentication key is located at 0x48 (0x40 + 0x08 offset) to 0x57 (0x40 + 0x17 offset). The new authentication key can be written to the corresponding locations (0x48 to 0x57) using the *BlockData()* command. The data is transferred to the data flash when the correct checksum for the whole block (0x40 to 0x5f) is written to *BlockDataChecksum()* (0x60). The checksum is (255- x) where x is the 8-bit summation of the *BlockData()* (0x40 to 0x5F) on a byte-by-byte basis. Once the authentication key is written, the gauge can then be SEALED again.

KEY PROGRAMMING (THE SECURE MEMORY KEY)

As the name suggests, the bq27541-G1 secure-memory authentication key is stored in the secure memory of the bq27541-G1. If a secure-memory key has been established, only this key can be used for authentication challenges (the programmable data flash key is not available). The selected key can only be established/programmed by special arrangements with TI, using the TI's *Secure B-to-B Protocol*. The secure-memory key can never be changed or read from the bq27541-G1.

EXECUTING AN AUTHENTICATION QUERY

To execute an authentication query in UNSEALED mode, a host must first write 0x01 to the *BlockDataControl()* command, to enable the authentication data commands. If in SEALED mode, 0x00 must be written to *DataFlashBlock()*, instead.

Next, the host writes a 20-byte authentication challenge to the *Authenticate()* address locations (0x40 through 0x53). After a valid checksum for the challenge is written to *AuthenticateChecksum()*, the bq27541-G1 uses the challenge to perform the SHA-1/HMAC computation, in conjunction with the programmed key. The resulting digest is written to *AuthenticateData()*, overwriting the pre-existing challenge. The host may then read this response and compare it against the result created by its own parallel computation.

HDQ SINGLE-PIN SERIAL INTERFACE

The HDQ interface is an asynchronous return-to-one protocol where a processor sends the command code to the bq27541-G1. With HDQ, the least significant bit (LSB) of a data byte (command) or word (data) is transmitted first. Note that the DATA signal on pin 12 is open-drain and requires an external pull-up resistor. The 8-bit command code consists of two fields: the 7-bit HDQ command code (bits 0–6) and the 1-bit R/W field (MSB bit 7). The R/W field directs the bq27541-G1 either to

- Store the next 8 or 16 bits of data to a specified register or
- Output 8 bits of data from the specified register

The HDQ peripheral can transmit and receive data as either an HDQ master or slave.

HDQ serial communication is normally initiated by the host processor sending a break command to the bq27541-G1. A break is detected when the DATA pin is driven to a logic-low state for a time $t_{(B)}$ or greater. The DATA pin should then be returned to its normal ready high logic state for a time $t_{(BR)}$. The bq27541-G1 is now ready to receive information from the host processor.

The bq27541-G1 is shipped in the I2C mode. TI provides tools to enable the HDQ peripheral.

HDQ HOST INTERRUPTION FEATURE

The default bq27541-G1 behaves as an HDQ slave only device. If the HDQ interrupt function is enabled, the bq27541-G1 is capable of mastering and also communicating to a HDQ device. There is no mechanism for negotiating who is to function as the HDQ master and care must be taken to avoid message collisions. The interrupt is signaled to the host processor with the bq27541-G1 mastering an HDQ "message". This message is a fixed message that will be used to signal the interrupt condition. The message itself is 0x80 (slave write to register 0x00) with no data byte being sent as the command is not intended to convey any status of the interrupt condition. The HDQ interrupt function is not public and needs to be enabled by command.

When the SET_HDQINTEN subcommand is received, the bq27541-G1 will detect any of the interrupt conditions and assert the interrupt at one second intervals until the CLEAR_HDQINTEN command is received or the count of HDQHostIntrTries has lapsed.

The number of tries for interrupting the host will be determined the data flash parameter named Configuration.Register.HDQHostIntrTries.

Low Battery Capacity

This feature will work identically to SOC1. It will use the same data flash entries as SOC1 and will trigger interrupts as long as SOC1 = 1.

Temperature

This feature will trigger an interrupt based on the OTC (Over-Temperature in Charge) or OTD (Over-Temperature in Discharge) condition being met. It uses the same data flash entries as OTC or OTD and will trigger interrupts as long as either the OTD or OTC condition is met and *HDQIntEN*=1.

I²C INTERFACE

The fuel gauge supports the standard I²C read, incremental read, one-byte write quick read, and functions. The 7-bit device address (ADDR) is the most significant 7 bits of the hex address and is fixed as 1010101. The 8-bit device address is therefore 0xAA or 0xAB for write or read, respectively.

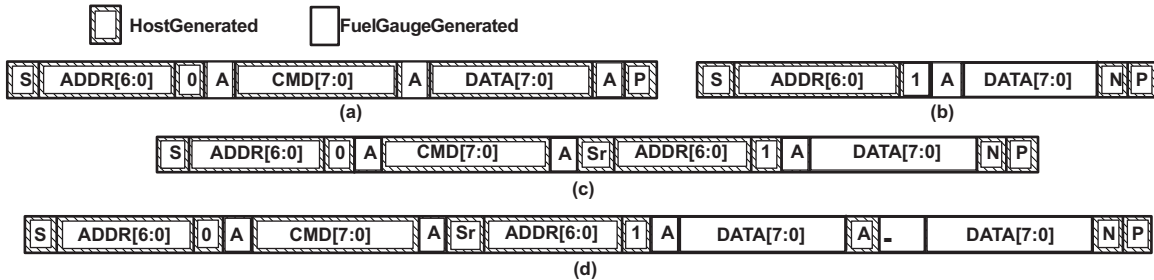

Figure 4. Supported I²C formats: (a) 1-byte write, (b) quick read, (c) 1 byte-read, and (d) incremental read (S = Start, Sr = Repeated Start, A = Acknowledge, N = No Acknowledge, and P = Stop).

The "quick read" returns data at the address indicated by the address pointer. The address pointer, a register internal to the I2C communication engine, increments whenever data is acknowledged by the bq27541-G1 or the I2C master. "Quick writes" function in the same manner and are a convenient means of sending multiple bytes to consecutive command locations (such as two-byte commands that require two bytes of data).

Attempt to write a read-only address (NACK after data sent by master):



Attempt to read an address above 0x7F (NACK command):



Attempt at incremental writes (NACK all extra data bytes sent):

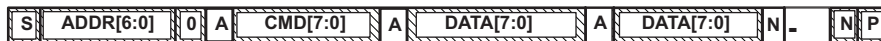

Incremental read at the maximum allowed read address:

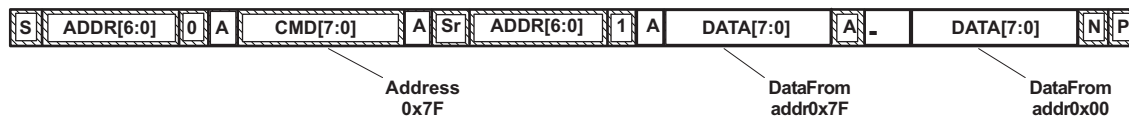

The I²C engine releases both SDA and SCL if the I²C bus is held low for $t_{(BUSERR)}$. If the fuel gauge was holding the lines, releasing them frees the master to drive the lines. If an external condition is holding either of the lines low, the I²C engine enters the low-power sleep mode.

I²C Time Out

The I2C engine will release both SDA and SCL if the I2C bus is held low for about 2 seconds. If the bq27541-G1 was holding the lines, releasing them will free for the master to drive the lines.

PRODUCTPREVIEW

I²C Command Waiting Time

To make sure the correct results of a command with the 400KHz I²C operation, a proper waiting time should be added between issuing command and reading results. For subcommands, the following diagram shows the waiting time required between issuing the control command the reading the status with the exception of the checksum command. A 100ms waiting time is required between the checksum command and reading result. For read-write standard commands, a minimum of 2 seconds is required to get the result updated. For read-only standard commands, there is no waiting time required, but the host should not issue all standard commands more than two times per second. Otherwise, the gauge could result in a reset issue due to the expiration of the watchdog timer.

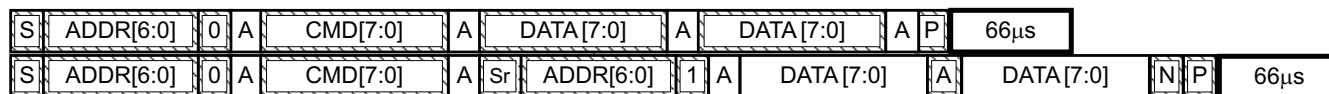

Waiting time between control subcommand and reading results



Waiting time between continuous reading results

The I²C clock stretch could happen in a typical application. A maximum 80ms clock stretch could be observed during the flash updates. There is up to 270ms clock stretch after the OCV command is issued.

PRODUCT PREVIEW

REFERENCE SCHEMATIC

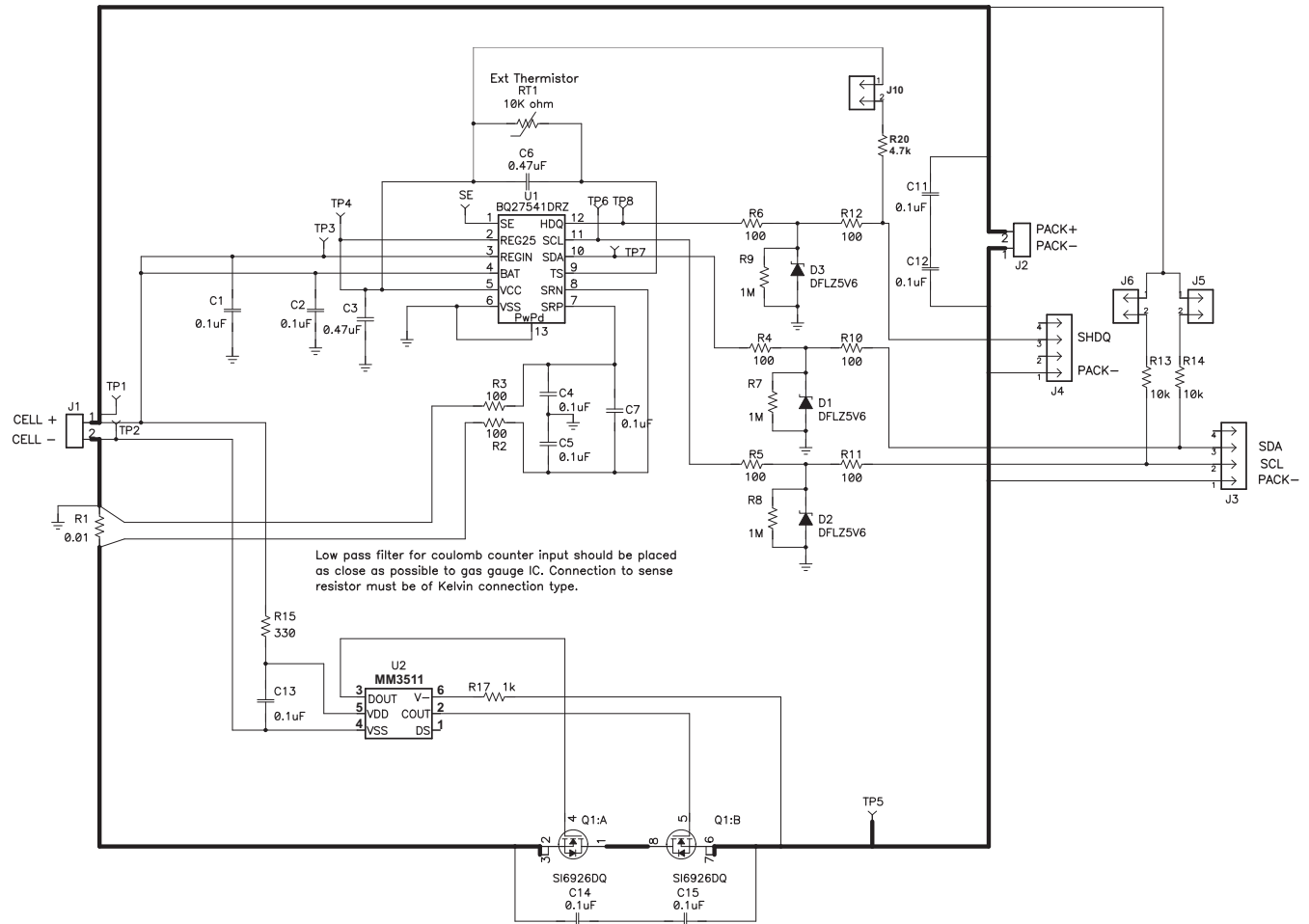

R7, R8, and R9 are optional pull-down resistors if pull-up resistors are applied.

PRODUCTPREVIEW

PACKAGING INFORMATION

Orderable Device	Status ⁽¹⁾	Package Type	Package Drawing	Pins	Package Qty	Eco Plan ⁽²⁾	Lead/ Ball Finish	MSL Peak Temp ⁽³⁾	Samples (Requires Login)
BQ27541DRZR-G1	PREVIEW	SON	DRZ	12	3000	Green (RoHS & no Sb/Br)	Call TI	Level-2-260C-1 YEAR	
BQ27541DRZT-G1	PREVIEW	SON	DRZ	12	250	Green (RoHS & no Sb/Br)	Call TI	Level-2-260C-1 YEAR	

⁽¹⁾ The marketing status values are defined as follows:

ACTIVE: Product device recommended for new designs.

LIFEBUY: TI has announced that the device will be discontinued, and a lifetime-buy period is in effect.

NRND: Not recommended for new designs. Device is in production to support existing customers, but TI does not recommend using this part in a new design.

PREVIEW: Device has been announced but is not in production. Samples may or may not be available.

OBSOLETE: TI has discontinued the production of the device.

⁽²⁾ Eco Plan - The planned eco-friendly classification: Pb-Free (RoHS), Pb-Free (RoHS Exempt), or Green (RoHS & no Sb/Br) - please check <http://www.ti.com/productcontent> for the latest availability information and additional product content details.

TBD: The Pb-Free/Green conversion plan has not been defined.

Pb-Free (RoHS): TI's terms "Lead-Free" or "Pb-Free" mean semiconductor products that are compatible with the current RoHS requirements for all 6 substances, including the requirement that lead not exceed 0.1% by weight in homogeneous materials. Where designed to be soldered at high temperatures, TI Pb-Free products are suitable for use in specified lead-free processes.

Pb-Free (RoHS Exempt): This component has a RoHS exemption for either 1) lead-based flip-chip solder bumps used between the die and package, or 2) lead-based die adhesive used between the die and leadframe. The component is otherwise considered Pb-Free (RoHS compatible) as defined above.

Green (RoHS & no Sb/Br): TI defines "Green" to mean Pb-Free (RoHS compatible), and free of Bromine (Br) and Antimony (Sb) based flame retardants (Br or Sb do not exceed 0.1% by weight in homogeneous material)

⁽³⁾ MSL, Peak Temp. -- The Moisture Sensitivity Level rating according to the JEDEC industry standard classifications, and peak solder temperature.

Important Information and Disclaimer: The information provided on this page represents TI's knowledge and belief as of the date that it is provided. TI bases its knowledge and belief on information provided by third parties, and makes no representation or warranty as to the accuracy of such information. Efforts are underway to better integrate information from third parties. TI has taken and continues to take reasonable steps to provide representative and accurate information but may not have conducted destructive testing or chemical analysis on incoming materials and chemicals. TI and TI suppliers consider certain information to be proprietary, and thus CAS numbers and other limited information may not be available for release.

In no event shall TI's liability arising out of such information exceed the total purchase price of the TI part(s) at issue in this document sold by TI to Customer on an annual basis.

DRZ (S-PDSO-N12)

PLASTIC SMALL OUTLINE

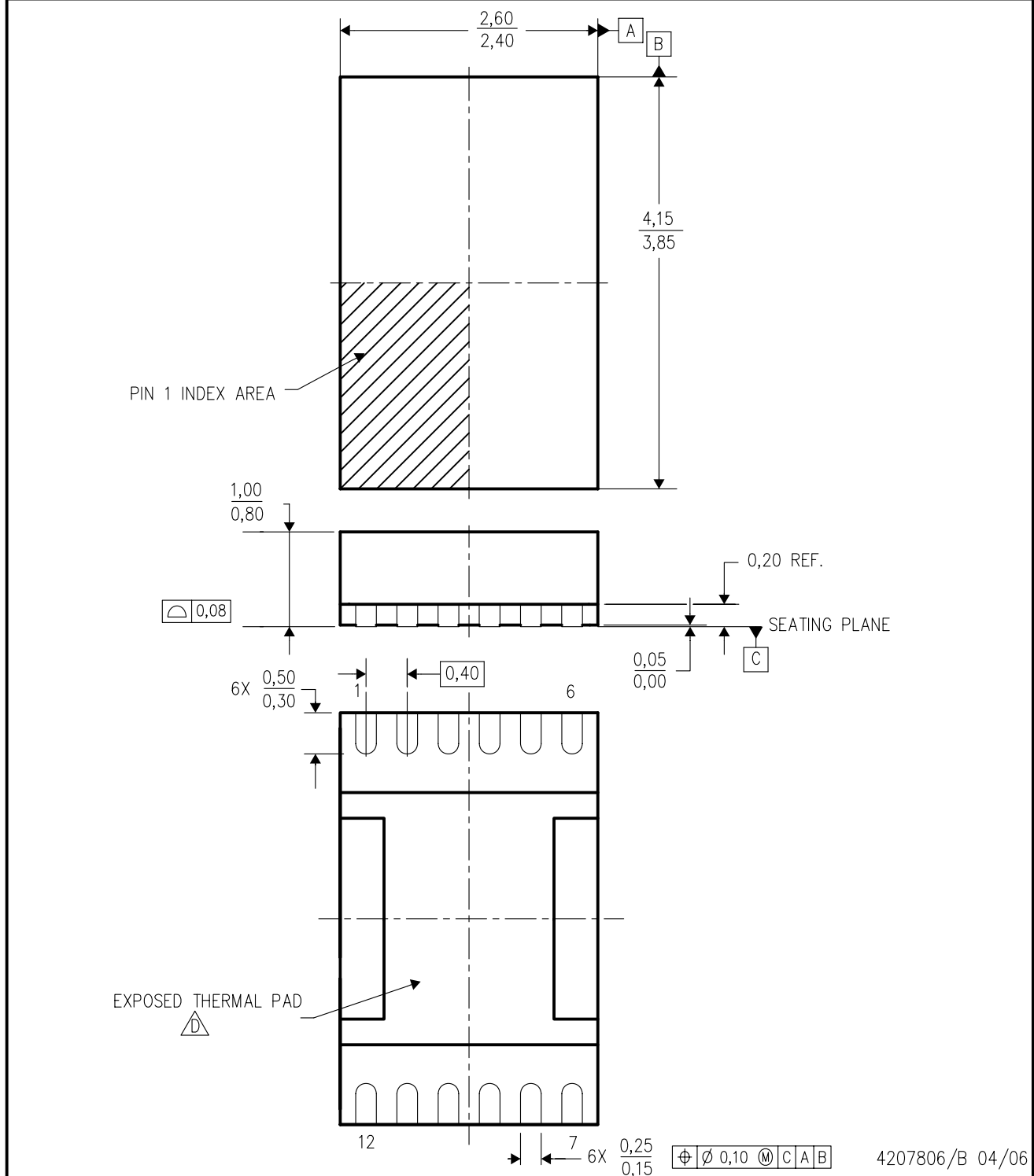

- NOTES:
- A. All linear dimensions are in millimeters. Dimensioning and tolerancing per ASME Y14.5M-1994.
 - B. This drawing is subject to change without notice.
 - C. Small Outline No-Lead (SON) package configuration.
 - D. The package thermal pad must be soldered to the board for thermal and mechanical performance. See the Product Data Sheet for details regarding the exposed thermal pad dimensions.
 - E. This package is lead-free.

THERMAL PAD MECHANICAL DATA

DRZ (R-PDSO-N12)

PLASTIC SMALL OUTLINE NO-LEAD

THERMAL INFORMATION

This package incorporates an exposed thermal pad that is designed to be attached directly to an external heatsink. The thermal pad must be soldered directly to the printed circuit board (PCB). After soldering, the PCB can be used as a heatsink. In addition, through the use of thermal vias, the thermal pad can be attached directly to the appropriate copper plane shown in the electrical schematic for the device, or alternatively, can be attached to a special heatsink structure designed into the PCB. This design optimizes the heat transfer from the integrated circuit (IC).

For information on the Quad Flatpack No-Lead (QFN) package and its advantages, refer to Application Report, QFN/SON PCB Attachment, Texas Instruments Literature No. SLUA271. This document is available at www.ti.com.

The exposed thermal pad dimensions for this package are shown in the following illustration.

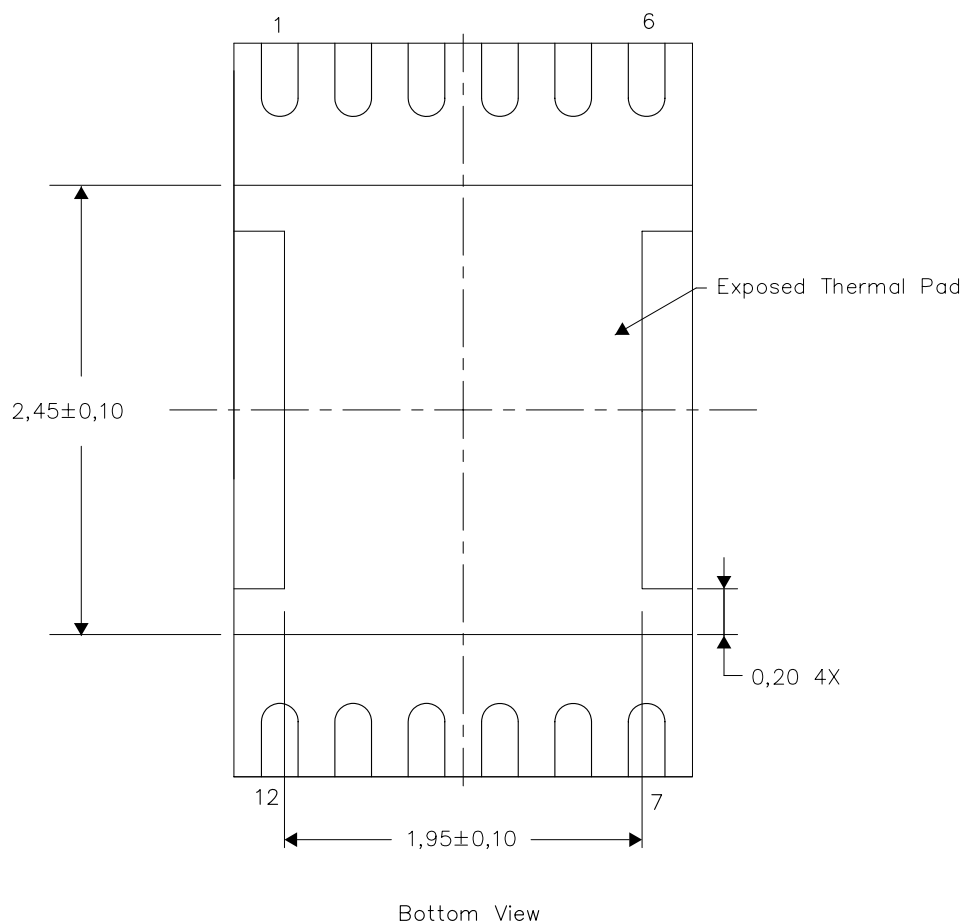

NOTE: All linear dimensions are in millimeters

Exposed Thermal Pad Dimensions

4208114/E 06/10

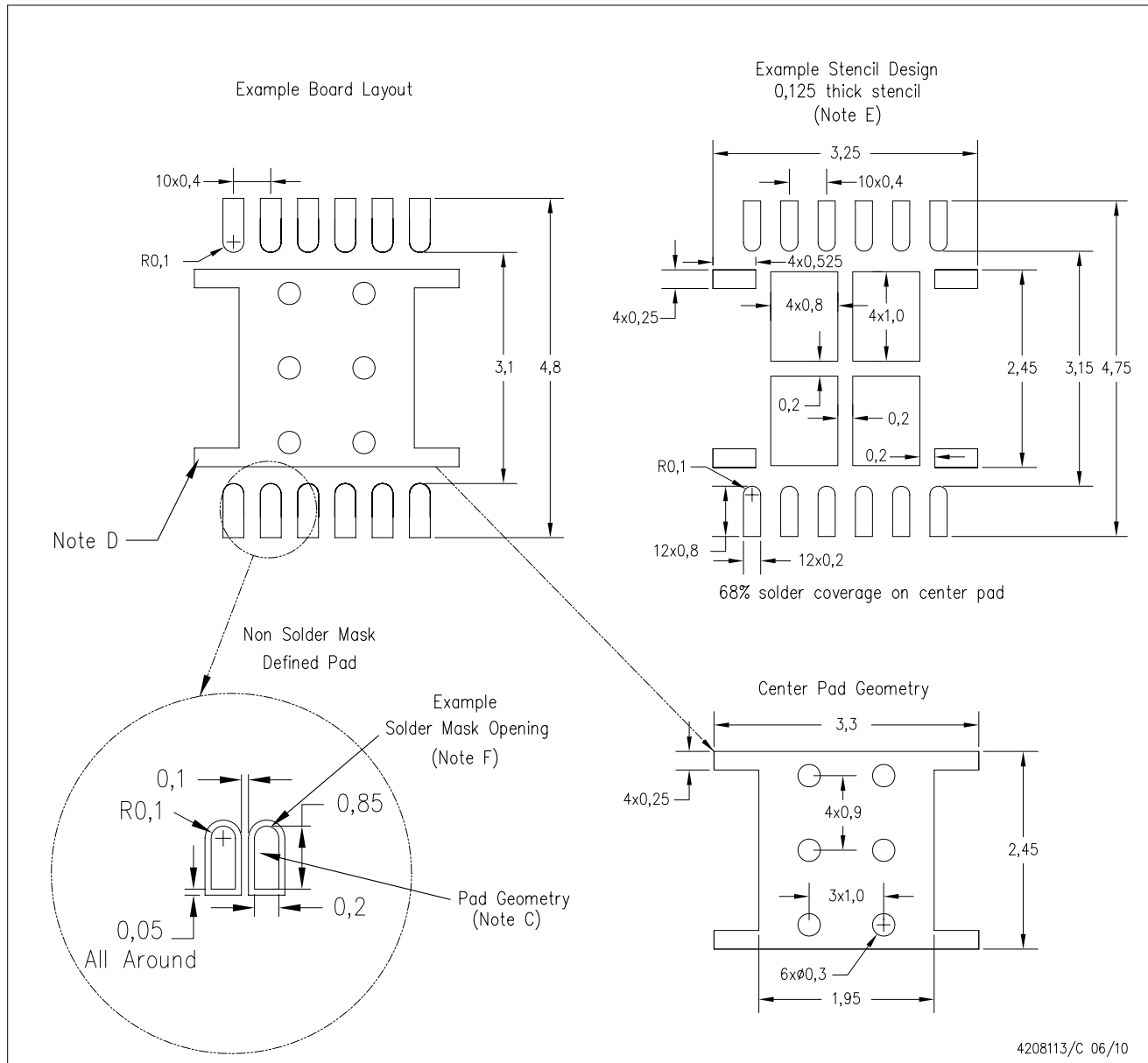

4208113/C 06/10

- NOTES:
- All linear dimensions are in millimeters.
 - This drawing is subject to change without notice.
 - Publication IPC-7351 is recommended for alternate designs.
 - This package is designed to be soldered to a thermal pad on the board. Refer to Application Note, Quad Flat-Pack Packages, Texas Instruments Literature No. SCBA017, SLUA271, and also the Product Data Sheets for specific thermal information, via requirements, and recommended board layout. These documents are available at www.ti.com <<http://www.ti.com>>.
 - Laser cutting apertures with trapezoidal walls and also rounding corners will offer better paste release. Customers should contact their board assembly site for stencil design recommendations. Refer to IPC 7525 for stencil design considerations.
 - Customers should contact their board fabrication site for minimum solder mask web tolerances between signal pads.

IMPORTANT NOTICE

Texas Instruments Incorporated and its subsidiaries (TI) reserve the right to make corrections, modifications, enhancements, improvements, and other changes to its products and services at any time and to discontinue any product or service without notice. Customers should obtain the latest relevant information before placing orders and should verify that such information is current and complete. All products are sold subject to TI's terms and conditions of sale supplied at the time of order acknowledgment.

TI warrants performance of its hardware products to the specifications applicable at the time of sale in accordance with TI's standard warranty. Testing and other quality control techniques are used to the extent TI deems necessary to support this warranty. Except where mandated by government requirements, testing of all parameters of each product is not necessarily performed.

TI assumes no liability for applications assistance or customer product design. Customers are responsible for their products and applications using TI components. To minimize the risks associated with customer products and applications, customers should provide adequate design and operating safeguards.

TI does not warrant or represent that any license, either express or implied, is granted under any TI patent right, copyright, mask work right, or other TI intellectual property right relating to any combination, machine, or process in which TI products or services are used. Information published by TI regarding third-party products or services does not constitute a license from TI to use such products or services or a warranty or endorsement thereof. Use of such information may require a license from a third party under the patents or other intellectual property of the third party, or a license from TI under the patents or other intellectual property of TI.

Reproduction of TI information in TI data books or data sheets is permissible only if reproduction is without alteration and is accompanied by all associated warranties, conditions, limitations, and notices. Reproduction of this information with alteration is an unfair and deceptive business practice. TI is not responsible or liable for such altered documentation. Information of third parties may be subject to additional restrictions.

Resale of TI products or services with statements different from or beyond the parameters stated by TI for that product or service voids all express and any implied warranties for the associated TI product or service and is an unfair and deceptive business practice. TI is not responsible or liable for any such statements.

TI products are not authorized for use in safety-critical applications (such as life support) where a failure of the TI product would reasonably be expected to cause severe personal injury or death, unless officers of the parties have executed an agreement specifically governing such use. Buyers represent that they have all necessary expertise in the safety and regulatory ramifications of their applications, and acknowledge and agree that they are solely responsible for all legal, regulatory and safety-related requirements concerning their products and any use of TI products in such safety-critical applications, notwithstanding any applications-related information or support that may be provided by TI. Further, Buyers must fully indemnify TI and its representatives against any damages arising out of the use of TI products in such safety-critical applications.

TI products are neither designed nor intended for use in military/aerospace applications or environments unless the TI products are specifically designated by TI as military-grade or "enhanced plastic." Only products designated by TI as military-grade meet military specifications. Buyers acknowledge and agree that any such use of TI products which TI has not designated as military-grade is solely at the Buyer's risk, and that they are solely responsible for compliance with all legal and regulatory requirements in connection with such use.

TI products are neither designed nor intended for use in automotive applications or environments unless the specific TI products are designated by TI as compliant with ISO/TS 16949 requirements. Buyers acknowledge and agree that, if they use any non-designated products in automotive applications, TI will not be responsible for any failure to meet such requirements.

Following are URLs where you can obtain information on other Texas Instruments products and application solutions:

Products

Audio	www.ti.com/audio
Amplifiers	amplifier.ti.com
Data Converters	dataconverter.ti.com
DLP® Products	www.dlp.com
DSP	dsp.ti.com
Clocks and Timers	www.ti.com/clocks
Interface	interface.ti.com
Logic	logic.ti.com
Power Mgmt	power.ti.com
Microcontrollers	microcontroller.ti.com
RFID	www.ti-rfid.com
OMAP Mobile Processors	www.ti.com/omap
Wireless Connectivity	www.ti.com/wirelessconnectivity

Applications

Communications and Telecom	www.ti.com/communications
Computers and Peripherals	www.ti.com/computers
Consumer Electronics	www.ti.com/consumer-apps
Energy and Lighting	www.ti.com/energy
Industrial	www.ti.com/industrial
Medical	www.ti.com/medical
Security	www.ti.com/security
Space, Avionics and Defense	www.ti.com/space-avionics-defense
Transportation and Automotive	www.ti.com/automotive
Video and Imaging	www.ti.com/video

TI E2E Community Home Page

e2e.ti.com

Mailing Address: Texas Instruments, Post Office Box 655303, Dallas, Texas 75265
Copyright © 2011, Texas Instruments Incorporated