

Reversible Motor Drivers for Brush Motors

1.0A Reversible Motor Drivers (Single Motor)



BA6956AN, BA6287F, BA6285FS, BA6285AFP-Y, BA6920FP-Y

No.11008EBT02

●Description

The reversible motor driver for output 1.0A for 1 motor can set the output modes to four modes, normal, reverse, stop (idling), and braking in accordance with logic input (2 inputs).

●Features

- 1) Built-in surge absorption diode
- 2) By built-in power save circuit, current consumption when a motor stops (idles) can be suppressed
- 3) Output voltage can be optionally set by reference voltage setting pin
- 4) Built-in thermal shutdown circuit (TSD)

●Applications

Audio-visual equipment; PC peripherals; Car audios; Car navigation systems; OA equipments

●Absolute maximum ratings (Ta=25°C, All voltages are with respect to ground)

Parameter	Symbol	Ratings					Unit
		BA6956AN	BA6287F	BA6285FS	BA6285AFP-Y	BA6920FP-Y	
Supply voltage	VCC	18	18	18	30	36	V
Supply voltage	VM	18	18	18	30	36	V
Output current	I _{OMAX}	1* ¹	1* ¹	1* ¹	1* ¹	1* ¹	A
Operating temperature	T _{OPR}	-20 ~ 75	-20 ~ 75	-20 ~ 75	-40 ~ 85	-30 ~ 85	°C
Storage temperature	T _{STG}	-55 ~ 150	-55 ~ 150	-55 ~ 150	-55 ~ 150	-55 ~ 150	°C
Power dissipation	Pd	1.19* ²	0.689* ³	0.813* ⁴	1.45* ⁵	1.45* ⁵	W
Junction temperature	T _{jmax}	150	150	150	150	150	°C

*1 Do not, exceed Pd or ASO.

*2 SIP9 package. Derated at 9.5mW/°C above 25°C.

*3 SOP8 package. Mounted on a 70mm x 70mm x 1.6mm FR4 glass-epoxy board with less than 3% copper foil. Derated at 5.52mW/°C above 25°C.

*4 SSOP-A16 package. Mounted on a 70mm x 70mm x 1.6mm FR4 glass-epoxy board with less than 3% copper foil. Derated at 6.5mW/°C above 25°C.

*5 HSOP25 package. Mounted on a 70mm x 70mm x 1.6mm FR4 glass-epoxy board with less than 3% copper foil. Derated at 11.6mW/°C above 25°C.

●Operating conditions (Ta=25°C)

Parameter	Symbol	Ratings					Unit
		BA6956AN	BA6287F	BA6285FS	BA6285AFP-Y	BA6920FP-Y	
Supply voltage	VCC	6.5 ~ 15	4.5 ~ 15	4.5 ~ 15	4.5 ~ 24	6.5 ~ 34	V
Supply voltage	VM	6.5 ~ 15	4.5 ~ 15	4.5 ~ 15	4.5 ~ 24	6.5 ~ 34	V
VREF voltage	VREF	< VCC, VM	< VCC, VM	< VCC, VM	< VCC, VM	< VCC, VM	V

● **Electrical characteristics** (BA6956AN, unless otherwise specified, Ta=25°C and VCC=9V, VM=9V)

Parameter	Symbol	Limits			Unit	Conditions
		Min.	Typ.	Max.		
Supply current 1	I _{CC1}	-	29	44	mA	FWD/REV mode
Supply current 2	I _{CC2}	-	56	80	mA	Brake mode
Supply current 3	I _{CC3}	-	0	15	μA	Standby mode
Input threshold voltage H	V _{IH}	2.0	-	VCC	V	
Input threshold voltage L	V _{IL}	0	-	0.8	V	
Input bias current	I _{IH}	50	90	131	μA	V _{IN} =2V
Output saturation voltage	V _{CE}	-	1.7	2.3	V	I _O =0.2A, vertically total
VREF bias current	I _{REF}	-	10	25	μA	I _O =0.2A, VREF=6V

● **Electrical characteristics** (BA6287F, unless otherwise specified, Ta=25°C and VCC=9V, VM=9V, VREF=9V)

Parameter	Symbol	Limits			Unit	Conditions
		Min.	Typ.	Max.		
Supply current 1	I _{CC1}	12	24	36	mA	FWD/REV mode
Supply current 2	I _{CC2}	29	48	67	mA	Brake mode
Standby current	I _{ST}	-	0	15	μA	Standby mode
Input threshold voltage H	V _{IH}	2.0	-	VCC	V	
Input threshold voltage L	V _{IL}	0	-	0.8	V	
Input bias current	I _{IH}	45	90	135	μA	V _{IN} =2V
Output saturation voltage	V _{CE}	-	1.0	1.5	V	I _O =0.2A, vertically total
VREF bias current	I _{REF}	6	12	18	mA	I _O =0.2A, FWD or REV mode

● **Electrical characteristics** (BA6285FS, unless otherwise specified, Ta=25°C and VCC=9V, VM=9V, VREF=9V)

Parameter	Symbol	Limits			Unit	Conditions
		Min.	Typ.	Max.		
Supply current 1	I _{CC1}	12	24	36	mA	FWD/REV mode
Supply current 2	I _{CC2}	29	48	67	mA	Brake mode
Standby current	I _{ST}	-	0	15	μA	Standby mode
Input threshold voltage H	V _{IH}	2.0	-	VCC	V	
Input threshold voltage L	V _{IL}	0	-	0.8	V	
Input bias current	I _{IH}	45	90	135	μA	V _{IN} =2V
Power save on voltage	V _{PSON}	2.0	-	VCC	V	Standby mode
Power save off voltage	V _{PSOFF}	0	-	0.8	V	Operation
Output saturation voltage	V _{CE}	-	1.0	1.5	V	I _O =0.2A, vertically total
VREF bias current	I _{REF}	6	12	18	mA	I _O =0.2A, FWD or REV mode

● **Electrical characteristics** (BA6285AFP-Y, unless otherwise specified, Ta=25°C and VCC=9V, VM=9V, VREF=9V)

Parameter	Symbol	Limits			Unit	Conditions
		Min.	Typ.	Max.		
Supply current 1	I _{CC1}	10	20	30	mA	FWD/REV mode
Supply current 2	I _{CC2}	21	42	63	mA	Brake mode
Standby current	I _{ST}	-	0	15	μA	Standby mode
Input threshold voltage H	V _{IH}	2.0	-	VCC	V	
Input threshold voltage L	V _{IL}	0	-	0.8	V	
Input bias current	I _{IH}	40	80	120	μA	V _{IN} =2V
Power save on voltage	V _{PSON}	-	-	0.8	V	Operation
Power save off voltage	V _{PSOFF}	2.0	-	VCC	V	Standby mode
Output saturation voltage	V _{CE}	-	1.0	1.5	V	I _O =0.2A, vertically total
VREF bias current	I _{REF}	9	15	21	mA	I _O =0.2A, FWD or REV mode

● **Electrical characteristics** (BA6920FP-Y, unless otherwise specified, Ta=25°C and VCC=12V, VM=12V)

Parameter	Symbol	Limits			Unit	Conditions
		Min.	Typ.	Max.		
Supply current 1	I _{CC1}	5	8	12	mA	FWD/REV mode
Supply current 2	I _{CC2}	3	5	8	mA	Brake mode
Standby current	I _{ST}	-	0	15	μA	Standby mode
Input threshold voltage H	V _{IH}	3.0	-	VCC	V	
Input threshold voltage L	V _{IL}	0	-	0.8	V	
Input bias current	I _{IH}	100	200	300	μA	V _{IN} =3V
Power save on voltage	V _{PSON}	2.0	-	VCC	V	Standby mode
Power save off voltage	V _{PSOFF}	-	-	0.8	V	Operation
Output saturation voltage	V _{CE}	-	2.2	3.3	V	I _O =0.2A, vertically total
VREF bias current	I _{REF}	-	12	35	μA	I _O =0.1A, VREF=6V

●Electrical characteristic curves (Reference data)

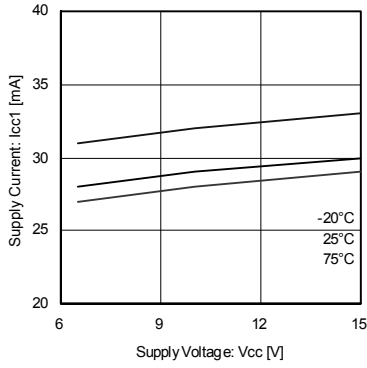

Fig.1 Supply current 1 (forward) (BA6956AN)

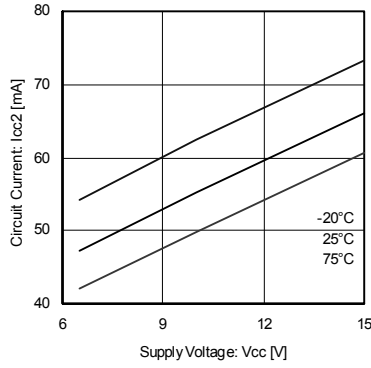

Fig.2 Supply current 2 (brake) (BA6956AN)

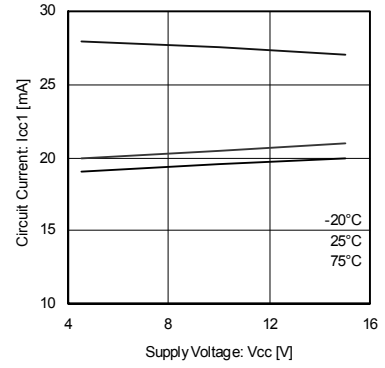

Fig.3 Supply current 1 (forward) (BA6287F)

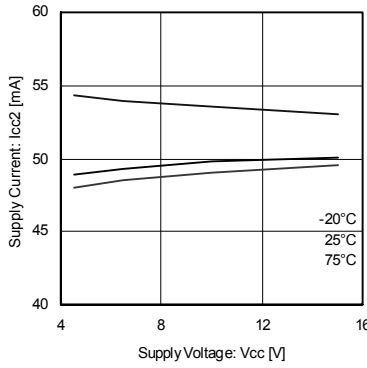

Fig.4 Supply current 2 (brake) (BA6287F)

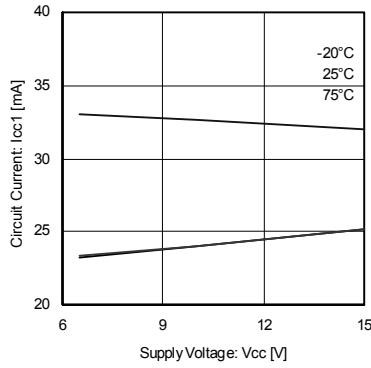

Fig.5 Supply current 1 (forward) (BA6285FS)

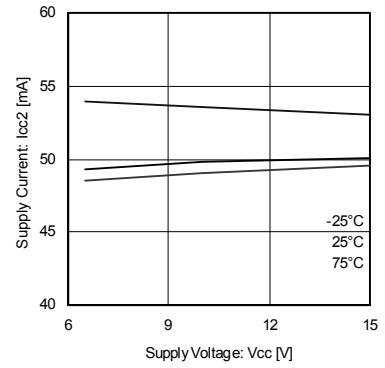

Fig.6 Supply current 2 (brake) (BA6285FS)

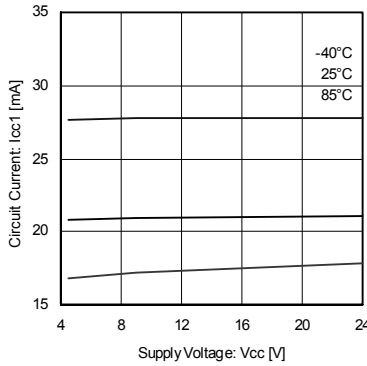

Fig.7 Supply current 1 (forward) (BA6285AFP-Y)

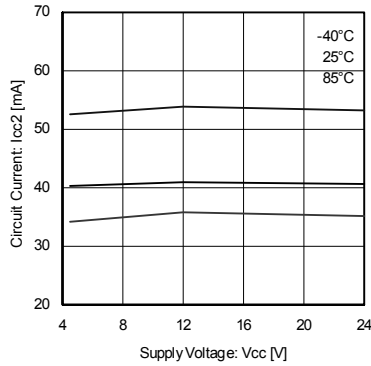

Fig.8 Supply current 2 (brake) (BA6285AFP-Y)

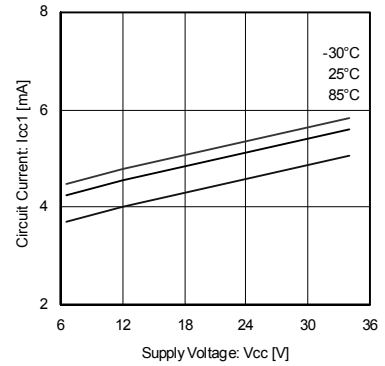

Fig.9 Supply current 1 (forward) (BA6920FP-Y)

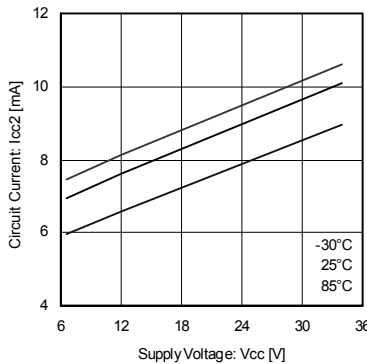

Fig.10 Supply current 2 (brake) (BA6920FP-Y)

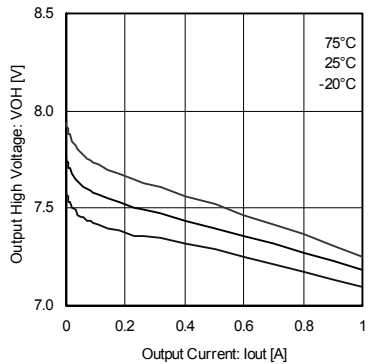

Fig.11 Output high voltage (BA6956AN)

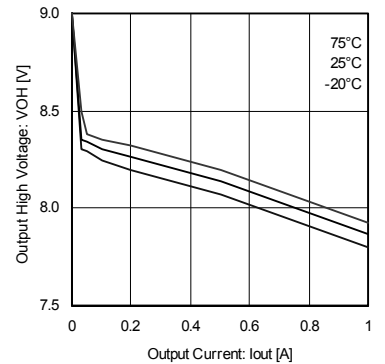

Fig.12 Output high voltage (BA6287F)

●Electrical characteristic curves (Reference data) - Continued

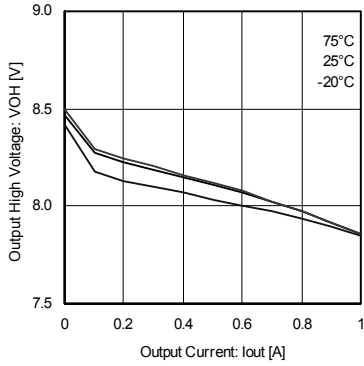

Fig. 13 Output high voltage (BA6285FS)

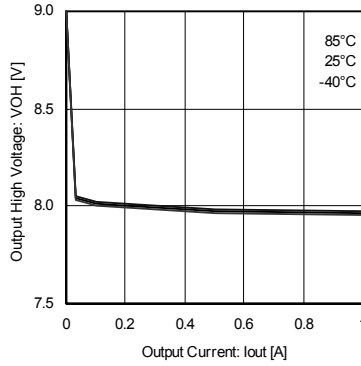

Fig. 14 Output high voltage (BA6285AFP-Y)

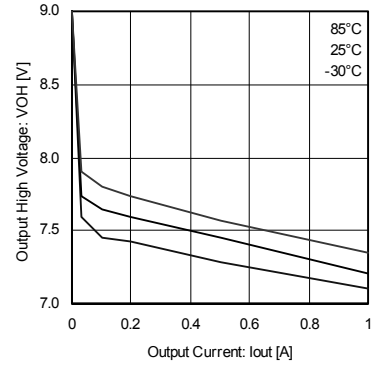

Fig. 15 Output high voltage (BA6920FP-Y)

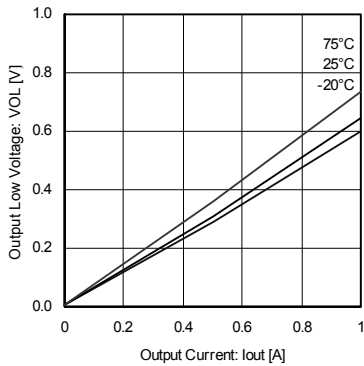

Fig. 16 Output low voltage (BA6956AN)

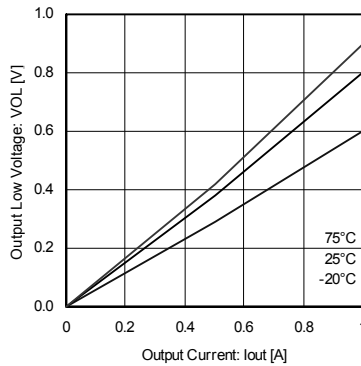

Fig. 17 Output low voltage (BA6287F)

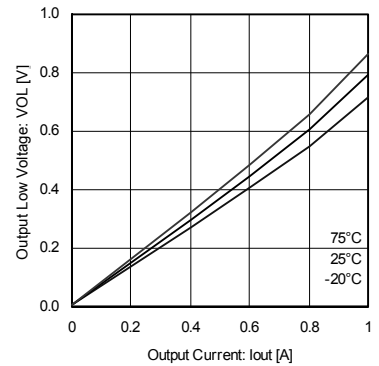

Fig. 18 Output low voltage (BA6285FS)

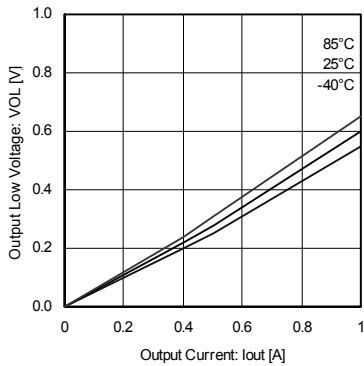

Fig. 19 Output low voltage (BA6285AFP-Y)

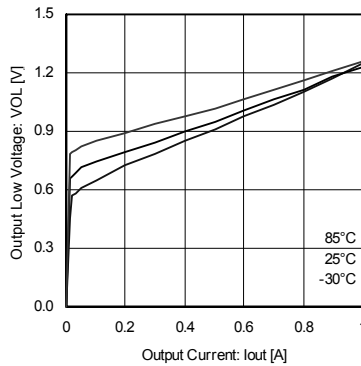

Fig. 20 Output low voltage (BA6920FP-Y)

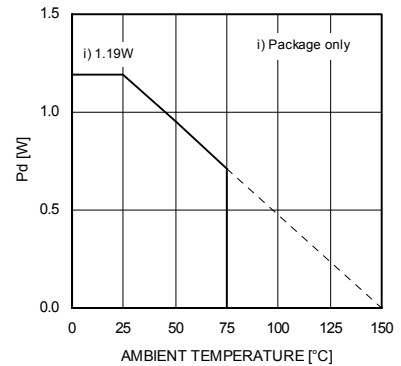

Fig. 21 Thermal derating curve (SIP9)

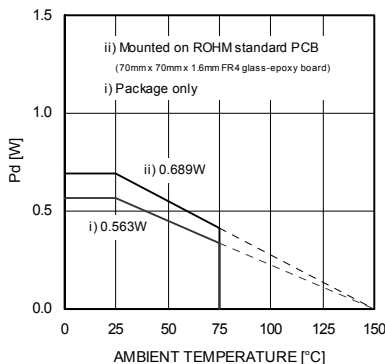

Fig. 22 Thermal derating curve (SOP8)

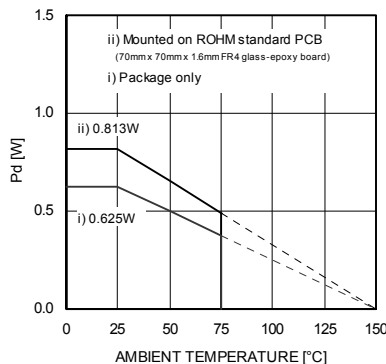

Fig. 23 Thermal derating curve (SSOP-A16)

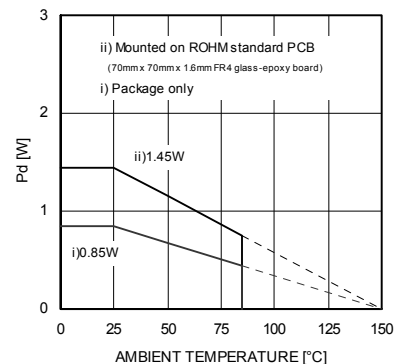

Fig. 24 Thermal derating curve (HSOP25)

●Block diagram and pin configuration

BA6956AN

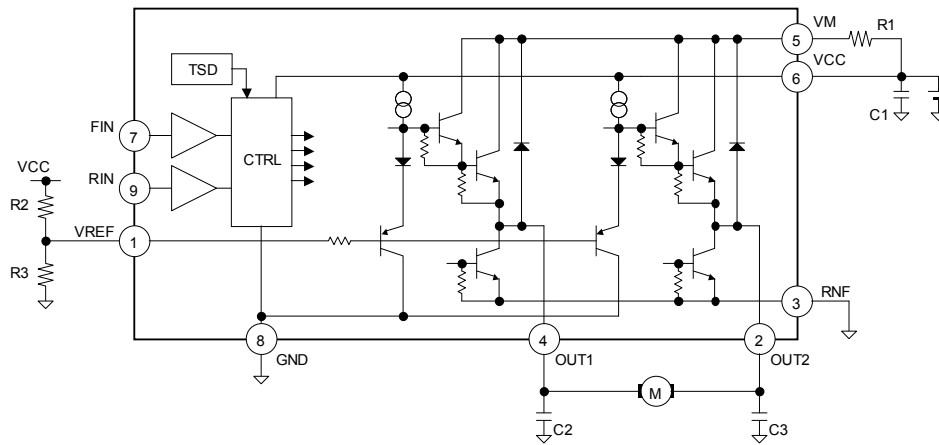

Fig.25 BA6956AN

Table 1 BA6956AN

Pin	Name	Function
1	VREF	Reference voltage setting pin
2	OUT2	Driver output
3	RNF	Power ground
4	OUT1	Driver output
5	VM	Power supply (driver stage)
6	VCC	Power supply (small signal)
7	FIN	Control input (forward)
8	GND	GND
9	RIN	Control input (reverse)

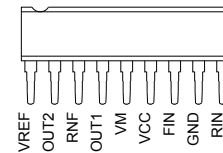

Fig.26 BA6956AN (SIP9)

●Block diagram and pin configuration

BA6287F

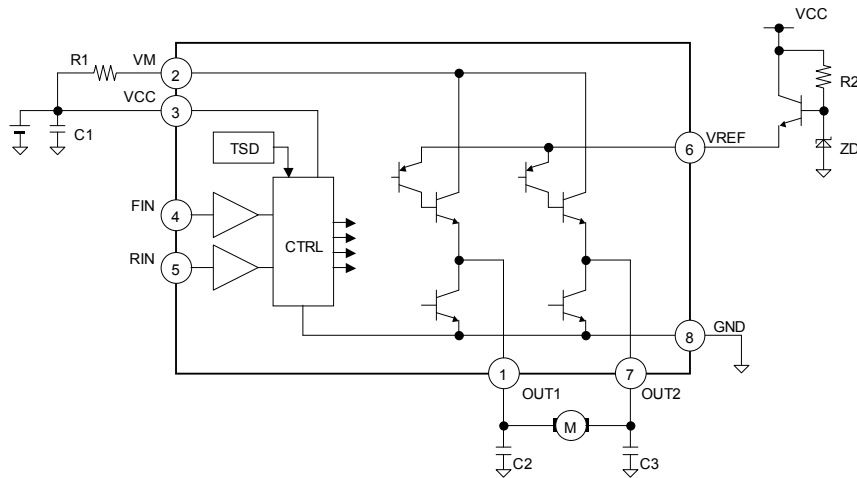

Fig.27 BA6287F

Table 2 BA6287F

Pin	Name	Function
1	OUT1	Driver output
2	VM	Power supply (driver stage)
3	VCC	Power supply (small signal)
4	FIN	Control input (forward)
5	RIN	Control input (reverse)
6	VREF	Reference voltage setting pin
7	OUT2	Driver output
8	GND	GND

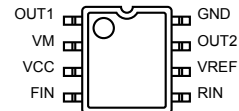

Fig.28 BA6287F (SOP8)

●Block diagram and pin configuration

BA6285FS

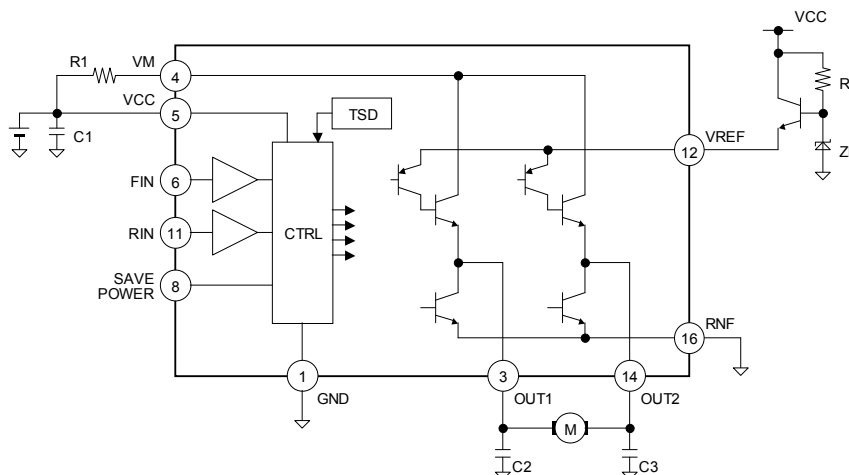

Fig.29 BA6285FS

Table 3 BA6285FS

Pin	Name	Function
1	GND	GND
2	NC	NC
3	OUT1	Driver output
4	VM	Power supply (driver stage)
5	VCC	Power supply (small signal)
6	FIN	Control input (forward)
7	NC	NC
8	PS	Power save enable pin
9	NC	NC
10	NC	NC
11	RIN	Control input (reverse)
12	VREF	Reference voltage setting pin
13	NC	NC
14	OUT2	Driver output
15	NC	NC
16	RNF	Power ground

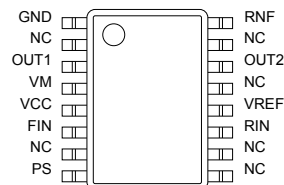

Fig.30 BA6285FS (SSOP-A16)

●Block diagram and pin configuration

BA6285AFP-Y

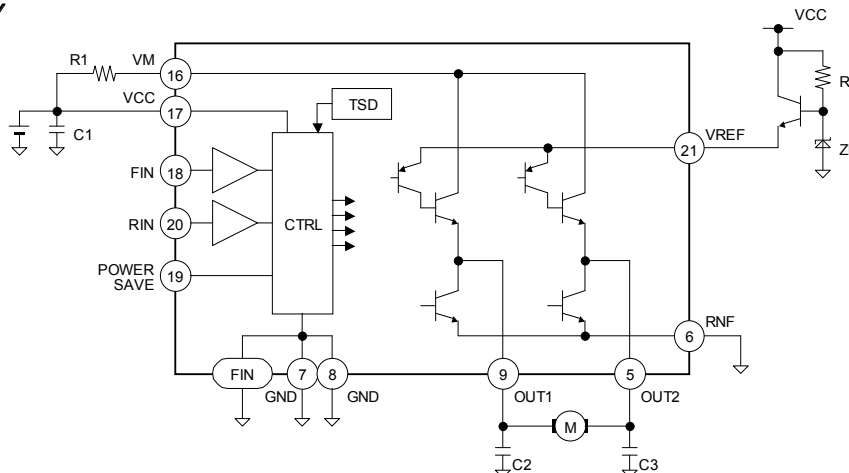

Fig.31 BA6285AFP-Y

Table 4 BA6285AFP-Y

Pin	Name	Function
1	NC	NC
2	NC	NC
3	NC	NC
4	NC	NC
5	OUT2	Driver output
6	RNF	Power ground
7	GND	GND
8	GND	GND
9	OUT1	Driver output
10	NC	NC
11	NC	NC
12	NC	NC
13	NC	NC
14	NC	NC
15	NC	NC
16	VM	Power supply (driver stage)
17	VCC	Power supply (small signal)
18	FIN	Control input (forward)
19	PS	Power save enable pin
20	RIN	Control input (reverse)
21	VREF	Reference voltage setting pin
22	NC	NC
23	NC	NC
24	NC	NC
25	NC	NC
FIN	GND	GND

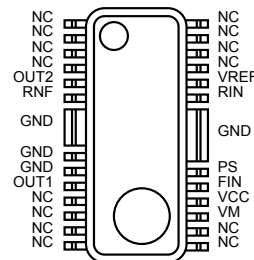

Fig.32 BA6285AFP-Y (HSOP25)

●Block diagram and pin configuration

BA6920FP-Y

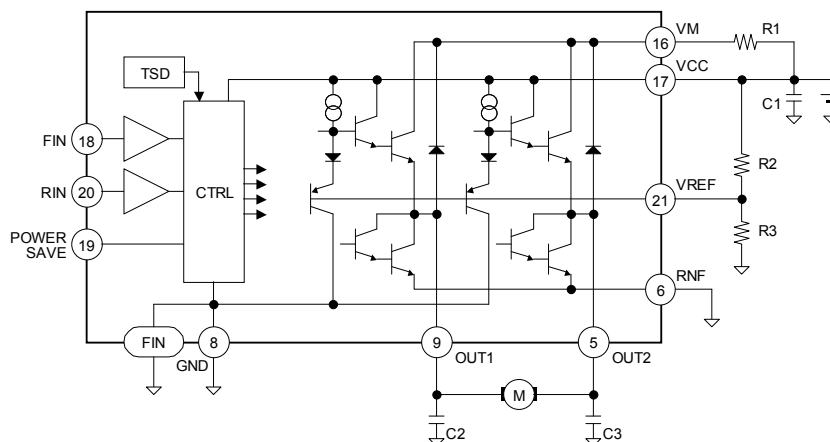

Fig.33 BA6920FP-Y

Table 5 BA6920FP-Y

Pin	Name	Function
1	NC	NC
2	NC	NC
3	NC	NC
4	NC	NC
5	OUT2	Driver output
6	RNF	Power ground
7	NC	NC
8	GND	GND
9	OUT1	Driver output
10	NC	NC
11	NC	NC
12	NC	NC
13	NC	NC
14	NC	NC
15	NC	NC
16	VM	Power supply (driver stage)
17	VCC	Power supply (small signal)
18	FIN	Control input (forward)
19	PS	Power save enable pin
20	RIN	Control input (reverse)
21	VREF	Reference voltage setting pin
22	NC	NC
23	NC	NC
24	NC	NC
25	NC	NC
FIN	GND	GND

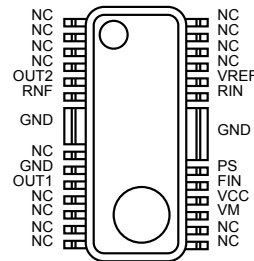

Fig.34 BA6920FP-Y (HSOP25)

● External application components

- 1) Resistor for the current limitation, R1
This is a current limiting resistor for collector loss reduction and at the time of short-circuited output. It depends on the power supply voltage used, etc., but choose resistance of about 5 to 10Ω. In addition, set resistance with utmost care to voltage drop caused by inrush current that flows when the motor is started.
- 2) Resistors and zener diode for the output high voltage setting, R2, R3 and ZD
These are the resistors and zener diode used when output high voltage is set. As for the voltage, only ($V_{SAT} + V_F$) lower than the VREF pin voltage for BA6287F, BA6285FS and BA6285AFP-Y. (Reference values; $V_{SAT} \approx 0.25V$, $V_F \approx 0.75V$) Zener diode ZD is recommended to be used instead of resistor R3 when the power supply voltage is unstable for BA6956AN and BA6920FP-Y.
- 3) Stabilization capacitor for the power supply line, C1
Please connect the capacitor of 1μF to 100μF for the stabilization of the power supply line, and confirm the motor operation.
- 4) Phase compensating capacitor, C2, C3
Noise is generated in output pins or oscillation results in accord with the set mounting state such as power supply circuit, motor characteristics, PCB pattern artwork, etc. As noise oscillation measures, connect 0.01μF to 0.1μF capacitors.

● Functional descriptions

- 1) Operation modes

Table 6 Logic table

IN1	IN2	OUT1	OUT2	Operation
L	L	OPEN*	OPEN*	Stop (idling)
H	L	H	L	Forward (OUT1 > OUT2)
L	H	L	H	Reverse (OUT1 < OUT2)
H	H	L	L	Brake (stop)

* OPEN is the off state of all output transistors. Please note that this is the state of the connected diodes, which differs from that of the mechanical relay.

** Output OUT1 and OUT2 become OPEN regardless of the input logic of FIN and RIN when switching to the power save mode with the POWERSAVE pin.

- a) Stand-by mode
In stand-by mode, all output power transistors are turned off, and the motor output goes to high impedance.
- b) Forward mode
This operating mode is defined as the forward rotation of the motor when the OUT1 pin is high and OUT2 pin is low. When the motor is connected between the OUT1 and OUT2 pins, the current flows from OUT1 to OUT2.
- c) Reverse mode
This operating mode is defined as the reverse rotation of the motor when the OUT1 pin is low and OUT2 pin is high. When the motor is connected between the OUT1 and OUT2 pins, the current flows from OUT2 to OUT1.
- d) Brake mode
This operating mode is used to quickly stop the motor (short circuit brake).

Note) Switching of rotating direction (FWD/REV)

When the rotating direction is changed over by the motor rotating condition, switch the direction after the motor is temporarily brought to the BRAKE condition or OPEN condition. It is recommended to keep the relevant conditions as follows:

- via BRAKE: Longer than braking time*. (* the time required for the output L terminal to achieve potential below GND when brake is activated.)
- via OPEN: The time longer than 1 ms is recommended.

2) Output high voltage setting

This function optionally sets output voltage by the output high voltage setting pin and controls the motor rotating speed. However, when the output high voltage is set to a low level, consumption at IC increases. Carry out thermal design with sufficient margin incorporated with the power dissipation (Pd) under the actual application condition taken into account.

a) BA6287F, BA6285FS, BA6285AFP-Y

The circuit diagram associated with the output high voltage setting VREF pin is as per shown on the right. The output high and low voltages V_{OH} and V_{OL} are expressed by:

$$V_{OH} = V_{REF} - (V_{SAT(Q1)} + V_{F(Q2)})$$

$$V_{OL} = V_{SAT(Q3)}$$

(Reference values; $V_{SAT} \approx 0.15V$, $V_F \approx 0.7V$)

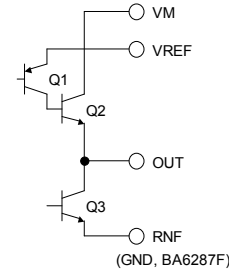

Fig.35 BA6287F, BA6285FS, BA6285AFP-Y

In addition, the relation of VREF voltage to output voltage is expressed by:

$$(V_{SAT(Q1)} + V_{F(Q2)}) < V_{REF} < VM - V_{SAT(Q2)} + V_{F(Q2)} + V_{SAT(Q1)}$$

Therefore, when the VREF voltage condition is as follows, the output high voltage is restricted.

$$V_{REF} > VM - V_{SAT(Q2)} + V_{SAT(Q1)} + V_{F(Q2)}$$

$$V_{OH} = VM - V_{SAT(Q2)}$$

b) BA6956AN, BA6920FP-Y

The circuit diagram associated with the output high voltage setting VREF pin is as per shown on the right. The output high and low voltages V_{OH} and V_{OL} are expressed by:

$$V_{OH} = V_{REF} + (V_{F(Q5)} + V_{F(Q4)}) - (V_{F(Q2)} + V_{F(Q3)})$$

$$\approx V_{REF}$$

$$V_{OL} = V_{SAT(Q6)} \text{ (BA6956AN)}$$

$$V_{OL} = V_{SAT(Q7)} + V_{F(Q6)} \text{ (BA6920FP-Y)}$$

(Reference values; $V_{SAT} \approx 0.15V$, $V_F \approx 0.7V$)

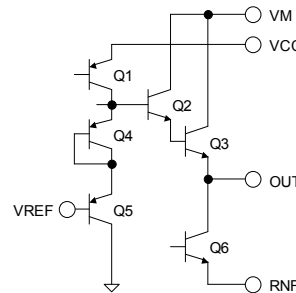

Fig.36 BA6956AN

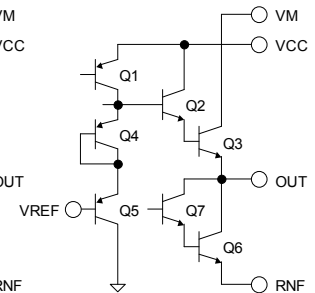

Fig.37 BA6920FP-Y

The output high voltage controllable range is expressed by:

$$V_{REF} < V_{CC} - V_{SAT(Q1)} - V_{F(Q4)} - V_{F(Q5)}$$

$$V_{REF} < VM - (V_{SAT(Q2)} + V_{F(Q3)}) + (V_{F(Q2)} + V_{F(Q3)}) - (V_{F(Q4)} + V_{F(Q5)}) \text{ (BA6956AN)}$$

$$V_{REF} < VM - V_{SAT(Q3)} + (V_{F(Q2)} + V_{F(Q3)}) - (V_{F(Q4)} + V_{F(Q5)}) \text{ (BA6920FP-Y)}$$

When the VREF voltage condition is as follows, the output high voltage is restricted.

$$V_{REF} > V_{CC} - V_{SAT(Q1)} - V_{F(Q4)} - V_{F(Q5)}$$

$$V_{REF} > VM - (V_{SAT(Q2)} + V_{F(Q3)}) + (V_{F(Q2)} + V_{F(Q3)}) - (V_{F(Q4)} + V_{F(Q5)}) \text{ (BA6956AN)}$$

$$V_{REF} > VM - V_{SAT(Q3)} + (V_{F(Q2)} + V_{F(Q3)}) - (V_{F(Q4)} + V_{F(Q5)}) \text{ (BA6920FP-Y)}$$

$$V_{OH} = V_{CC} - V_{SAT(Q1)} - V_{F(Q2)} - V_{F(Q3)}$$

$$V_{OH} = VM - V_{SAT(Q2)} - V_{F(Q3)} \text{ (BA6956AN)}$$

$$V_{OH} = VM - V_{SAT(Q3)} \text{ (BA6920FP-Y)}$$

● Interfaces

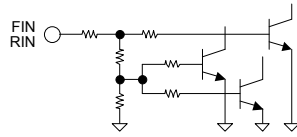
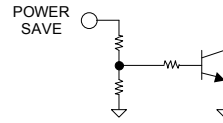
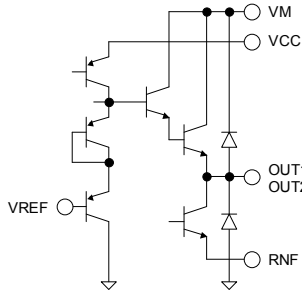

Fig. 38 FIN, RIN



(BA6285FS, BA6285AFP-Y, BA6920FP-Y)
Fig.39 POWER SAVE



(BA6956AN)

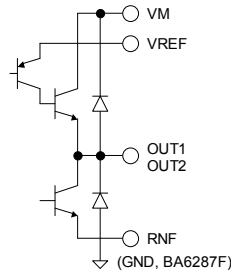

(BA6287F, BA6285FS, BA6285AFP-Y)

Fig. 40 VCC, VM, OUT1, OUT2, VREF, RNF, GND

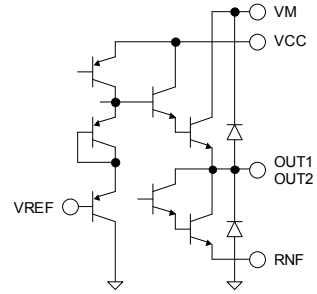

(BA6920FP-Y)

●Notes for use**1) Absolute maximum ratings**

Devices may be destroyed when supply voltage or operating temperature exceeds the absolute maximum rating. Because the cause of this damage cannot be identified as, for example, a short circuit or an open circuit, it is important to consider circuit protection measures – such as adding fuses – if any value in excess of absolute maximum ratings is to be implemented.

2) Connecting the power supply connector backward

Connecting the power supply in reverse polarity can damage the IC. Take precautions against reverse polarity when connecting the power supply lines, such as adding an external direction diode.

3) Power supply lines

Return current generated by the motor's Back-EMF requires countermeasures, such as providing a return current path by inserting capacitors across the power supply and GND (10 μ F, ceramic capacitor is recommended). In this case, it is important to conclusively confirm that none of the negative effects sometimes seen with electrolytic capacitors – including a capacitance drop at low temperatures - occurs. Also, the connected power supply must have sufficient current absorbing capability. Otherwise, the regenerated current will increase voltage on the power supply line, which may in turn cause problems with the product, including peripheral circuits exceeding the absolute maximum rating. To help protect against damage or degradation, physical safety measures should be taken, such as providing a voltage clamping diode across the power supply and GND.

4) Electrical potential at GND

Keep the GND terminal potential to the minimum potential under any operating condition. In addition, check to determine whether there is any terminal that provides voltage below GND, including the voltage during transient phenomena. When both a small signal GND and high current GND are present, single-point grounding (at the set's reference point) is recommended, in order to separate the small signal and high current GND, and to ensure that voltage changes due to the wiring resistance and high current do not affect the voltage at the small signal GND. In the same way, care must be taken to avoid changes in the GND wire pattern in any external connected component.

5) Thermal design

Use a thermal design that allows for a sufficient margin in light of the power dissipation (Pd) under actual operating conditions.

6) ASO - Area of Safety Operation

When using the IC, set the output transistor so that it does not exceed absolute maximum ratings or ASO.

7) Inter-pin shorts and mounting errors

Use caution when positioning the IC for mounting on printed circuit boards. The IC may be damaged if there is any connection error, or if pins are shorted together.

8) Operation in strong electromagnetic fields

Using this product in strong electromagnetic fields may cause IC malfunctions. Use extreme caution with electromagnetic fields.

9) Built-in thermal shutdown (TSD) circuit

The TSD circuit is designed only to shut the IC off to prevent thermal runaway. It is not designed to protect the IC or guarantee its operation in the presence of extreme heat. Do not continue to use the IC after the TSD circuit is activated, and do not operate the IC in an environment where activation of the circuit is assumed.

10) Capacitor between output and GND

In the event a large capacitor is connected between the output and GND, if VCC and VIN are short-circuited with 0V or GND for any reason, the current charged in the capacitor flows into the output and may destroy the IC. Use a capacitor smaller than 0.47 μ F between output and GND.

11) Testing on application boards

When testing the IC on an application board, connecting a capacitor to a low impedance pin subjects the IC to stress. Therefore, always discharge capacitors after each process or step. Always turn the IC's power supply off before connecting it to or removing it from the test setup during the inspection process. Ground the IC during assembly steps as an antistatic measure. Use similar precaution when transporting or storing the IC.

12) Regarding the input pin of the IC

This monolithic IC contains P+ isolation and P substrate layers between adjacent elements, in order to keep them isolated. P-N junctions are formed at the intersection of these P layers with the N layers of other elements, creating a parasitic diode or transistor. For example, the relation between each potential is as follows:

When $GND > Pin A$ and $GND > Pin B$, the P-N junction operates as a parasitic diode.

When $GND > Pin B$, the P-N junction operates as a parasitic transistor.

Parasitic diodes inevitably occur in the structure of the IC. The operation of parasitic diodes can result in mutual interference among circuits, as well as operating malfunctions and physical damage. Therefore, do not use methods by which parasitic diodes operate, such as applying a voltage lower than the GND (P substrate) voltage to an input pin.

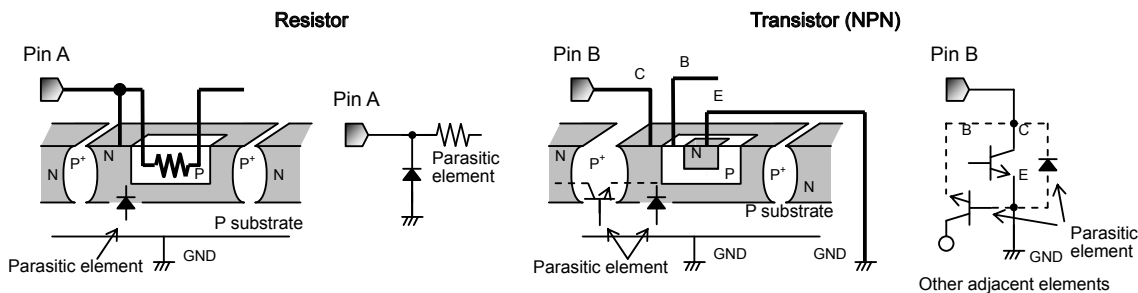

●Ordering part number

B	A	6	2	8	5	A	F	P	-	Y	E	2
Part No.		Part No.					Package				Packaging and forming specification	
		6956A 6287 6285 6285A 6920					N : SIP9 F : SOP8 FS : SSOP-A16 FP-Y : HSOP25				E2: Embossed tape and reel None: Tube	

SIP9

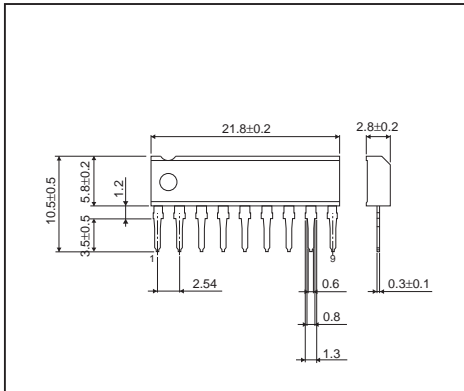

<Tape and Reel information>

Container	Tube
Quantity	1000pcs
Direction of feed	Direction of products is fixed in a container tube

*Order quantity needs to be multiple of the minimum quantity.

SOP8

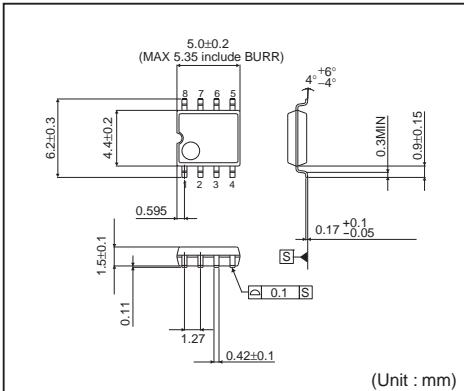

<Tape and Reel information>

Tape	Embossed carrier tape
Quantity	2500pcs
Direction of feed	E2 (The direction is the 1pin of product is at the upper left when you hold reel on the left hand and you pull out the tape on the right hand)

*Order quantity needs to be multiple of the minimum quantity.

SSOP-A16

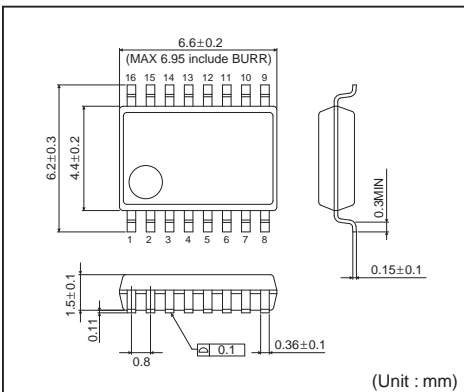

<Tape and Reel information>

Tape	Embossed carrier tape
Quantity	2500pcs
Direction of feed	E2 (The direction is the 1pin of product is at the upper left when you hold reel on the left hand and you pull out the tape on the right hand)

*Order quantity needs to be multiple of the minimum quantity.

HSOP25

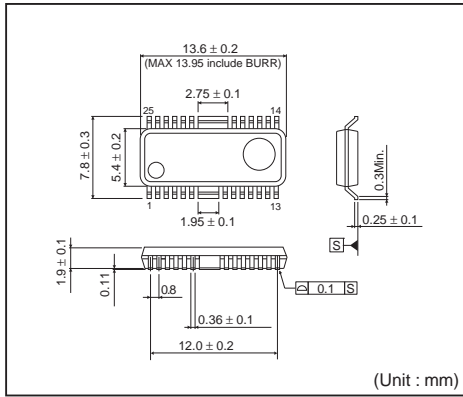

<Tape and Reel information>

Tape	Embossed carrier tape
Quantity	2000pcs
Direction of feed	E2 (The direction is the 1pin of product is at the upper left when you hold reel on the left hand and you pull out the tape on the right hand)

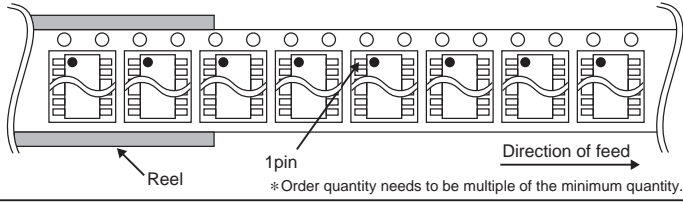

Notes

No copying or reproduction of this document, in part or in whole, is permitted without the consent of ROHM Co.,Ltd.

The content specified herein is subject to change for improvement without notice.

The content specified herein is for the purpose of introducing ROHM's products (hereinafter "Products"). If you wish to use any such Product, please be sure to refer to the specifications, which can be obtained from ROHM upon request.

Examples of application circuits, circuit constants and any other information contained herein illustrate the standard usage and operations of the Products. The peripheral conditions must be taken into account when designing circuits for mass production.

Great care was taken in ensuring the accuracy of the information specified in this document. However, should you incur any damage arising from any inaccuracy or misprint of such information, ROHM shall bear no responsibility for such damage.

The technical information specified herein is intended only to show the typical functions of and examples of application circuits for the Products. ROHM does not grant you, explicitly or implicitly, any license to use or exercise intellectual property or other rights held by ROHM and other parties. ROHM shall bear no responsibility whatsoever for any dispute arising from the use of such technical information.

The Products specified in this document are intended to be used with general-use electronic equipment or devices (such as audio visual equipment, office-automation equipment, communication devices, electronic appliances and amusement devices).

The Products specified in this document are not designed to be radiation tolerant.

While ROHM always makes efforts to enhance the quality and reliability of its Products, a Product may fail or malfunction for a variety of reasons.

Please be sure to implement in your equipment using the Products safety measures to guard against the possibility of physical injury, fire or any other damage caused in the event of the failure of any Product, such as derating, redundancy, fire control and fail-safe designs. ROHM shall bear no responsibility whatsoever for your use of any Product outside of the prescribed scope or not in accordance with the instruction manual.

The Products are not designed or manufactured to be used with any equipment, device or system which requires an extremely high level of reliability the failure or malfunction of which may result in a direct threat to human life or create a risk of human injury (such as a medical instrument, transportation equipment, aerospace machinery, nuclear-reactor controller, fuel-controller or other safety device). ROHM shall bear no responsibility in any way for use of any of the Products for the above special purposes. If a Product is intended to be used for any such special purpose, please contact a ROHM sales representative before purchasing.

If you intend to export or ship overseas any Product or technology specified herein that may be controlled under the Foreign Exchange and the Foreign Trade Law, you will be required to obtain a license or permit under the Law.



Thank you for your accessing to ROHM product informations.
More detail product informations and catalogs are available, please contact us.

ROHM Customer Support System

<http://www.rohm.com/contact/>