



Aluminum electrolytic capacitors

Snap-in capacitors

Series/Type: B41231
Date: November 2008

© EPCOS AG 2008. Reproduction, publication and dissemination of this publication, enclosures hereto and the information contained therein without EPCOS' prior express consent is prohibited.

General-purpose grade capacitors

Applications

- Switch-mode power supplies in industrial and entertainment electronics

Features

- High ripple current capability
- RoHS-compatible
- Useful life of 2000 h at 85 °C

Construction

- Aluminum case, fully insulated
- Snap-in solder pins to hold component in place on PC-board
- Minus pole marking on the insulating sleeve
- Case with safety vent

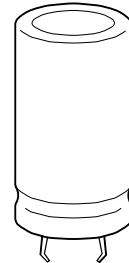

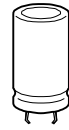
Specifications and characteristics in brief

Rated voltage V_R	10 ... 100 V DC								
Surge voltage V_S	$1.15 \cdot V_R$								
Rated capacitance C_R	1200 ... 68000 μ F								
Capacitance tolerance	$\pm 20\% \triangleq M$								
Dissipation factor (max.) (20 °C, 120 Hz)	V_R (V DC)	10	16	25	35	50	63	80	100
	$\tan \delta$	0.50	0.50	0.40	0.40	0.30	0.25	0.20	0.15
Leakage current I_{leak} (20 °C, after 5 minutes)	$I_{leak} \leq 0.02 \mu A \cdot \left(\frac{C_R}{\mu F} \cdot \frac{V_R}{V} \right)$								
Useful life 85 °C; V_R ; $I_{AC,R}$	> 2000 h	Requirements:							
		$\Delta C/C$	$\leq 20\%$ of initial value						
		$\tan \delta$	≤ 2 times initial specified limit						
		I_{leak}	\leq initial specified limit						
Shelf life	After storage for 1000 h at 85 °C, the capacitors shall meet the requirement of load life test after reforming process. After test: V_R to be applied for 30 minutes, 24 to 48 hours before measurement.								
Operating temperature range	–40 °C ... +85 °C								
Characteristics at low temperature	Max. impedance ratio at 120 Hz	V_R	10 V		16 ... 100 V				
		$Z_{-25^\circ C} / Z_{20^\circ C}$	5		4				
		$Z_{-40^\circ C} / Z_{20^\circ C}$	18		15				
Sectional specification	IEC 60384-4								

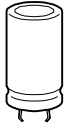

B41231

Standard series – 85 °C

Dimensional drawing

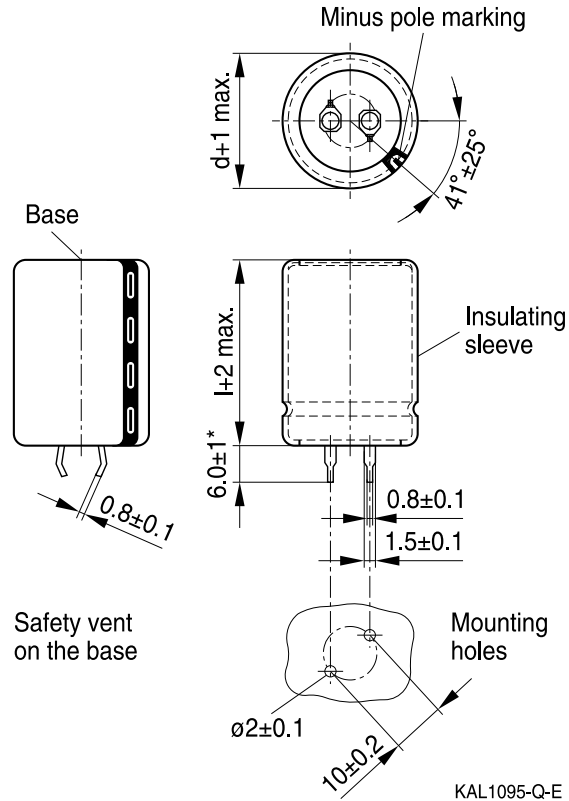

* = Shorter terminal (4.5 – 1) mm is also available upon request.

Dimensions (mm)		Approx. weight (g)	Packing units (pcs.)
d +1	l ±2		
22	25	13.0	200
22	30	15.0	100
22	35	20.5	100
22	40	23.0	100
22	45	25.0	100
22	50	29.5	100
25.4	25	13.5	100
25.4	30	19.5	50
25.4	35	25.0	50
25.4	40	28.0	50
25.4	45	31.0	50
25.4	50	39.0	50

Dimensions (mm)		Approx. weight (g)	Packing units (pcs.)
d +1	l ±2		
30	25	24.5	100
30	30	25.5	100
30	35	32.5	50
30	40	39.0	50
30	45	43.5	50
30	50	55.5	50
35	25	35.0	80
35	30	43.0	80
35	35	50.5	50
35	40	52.0	50
35	45	65.0	50
35	50	70.5	50

Overview of available types – B41231

V_R (V DC)	10	16	25	35	50	63	80	100
	Case dimensions $d \times l$ (mm)							
C_R (μ F)								
1200							22 × 25	22 × 30 25.4 × 25
1500							22 × 30	22 × 35 25.4 × 30 30 × 25
1800						22 × 25	22 × 30 25.4 × 25	22 × 40 25.4 × 35 30 × 30
2200						22 × 30 25.4 × 25	22 × 35 25.4 × 30 30 × 25	22 × 45 25.4 × 40 30 × 30
2700						22 × 35 25.4 × 30	22 × 40 25.4 × 35 30 × 30	25.4 × 45 30 × 35 35 × 30
3300					22 × 30 25.4 × 25	22 × 35 25.4 × 30 30 × 25	22 × 45 25.4 × 40 30 × 30	25.4 × 50 30 × 40 35 × 35
3900						22 × 40 25.4 × 35 30 × 30	22 × 50 25.4 × 45 30 × 35	30 × 45 35 × 35
4700				22 × 30 25.4 × 25	22 × 40 25.4 × 35 30 × 25 35 × 25	22 × 50 25.4 × 40 30 × 35 35 × 30	25.4 × 50 30 × 40 35 × 30	30 × 50 35 × 40
5600			22 × 25 25.4 × 30	22 × 35 25.4 × 40 30 × 30 35 × 25	22 × 45 25.4 × 40 30 × 30 35 × 25	25.4 × 45 30 × 35 35 × 30	30 × 45 35 × 35	35 × 45
6800			22 × 30 25.4 × 25	22 × 40 25.4 × 30 30 × 25	22 × 50 25.4 × 45 30 × 35 35 × 30	25.4 × 50 30 × 40 35 × 30	35 × 40	
8200			22 × 35 25.4 × 30	22 × 45 25.4 × 35 30 × 30	25.4 × 50 30 × 40 35 × 30	30 × 45 35 × 35	35 × 45	

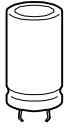
B41231
Standard series – 85 °C

V_R (V DC)	10	16	25	35	50	63	80	100
	Case dimensions $d \times l$ (mm)							
C_R (μ F)								
10000		22 × 25	22 × 40 25.4 × 30	22 × 50 25.4 × 40 30 × 30	30 × 45 35 × 35	30 × 50 35 × 40		
12000	22 × 25	22 × 30 25.4 × 25	22 × 45 25.4 × 35 30 × 25	25.4 × 45 30 × 35 35 × 30	30 × 50 35 × 40	35 × 45		
15000	22 × 30 25.4 × 25	22 × 35 25.4 × 30 30 × 25	22 × 50 25.4 × 40 30 × 30	30 × 40 35 × 35	35 × 45			
18000	22 × 35 25.4 × 25	22 × 40 25.4 × 35 30 × 30	25.4 × 45 30 × 35	30 × 45 35 × 40	35 × 50			
22000	22 × 40 25.4 × 30 30 × 25	22 × 50 25.4 × 40 30 × 30	30 × 35 35 × 30	35 × 45				
27000	22 × 45 25.4 × 35 30 × 30	25.4 × 45 30 × 35 35 × 25	30 × 45 35 × 35					
33000	22 × 50 25.4 × 40 30 × 30 35 × 25	30 × 40 35 × 30	30 × 50 35 × 40					
39000	25.4 × 45 30 × 35 35 × 30	30 × 45 35 × 35	35 × 45					
47000	25.4 × 50 30 × 40 35 × 30	30 × 50 35 × 40						
56000	30 × 45 35 × 35	35 × 45						
68000	35 × 40	35 × 50						

The capacitance and voltage ratings listed above are available in different cases upon request. Other voltage and capacitance ratings are also available upon request.

Technical data and ordering codes

C_R 120 Hz 20 °C μF	Case dimensions $d \times l$ mm	$\tan \delta_{\max}$ 120 Hz 20 °C	$I_{AC,\max}$ 120 Hz 60 °C A	$I_{AC,R}$ 120 Hz 85 °C A	Ordering code
$V_R = 10 \text{ V DC}$					
12000	22 × 25	0.50	6.55	3.31	B41231A3129M000
15000	22 × 30	0.50	7.56	3.82	B41231A3159M000
15000	25.4 × 25	0.50	6.71	3.39	B41231B3159M000
18000	22 × 35	0.50	8.47	4.28	B41231A3189M000
18000	25.4 × 25	0.50	8.26	4.17	B41231B3189M000
22000	22 × 40	0.50	9.48	4.79	B41231A3229M000
22000	25.4 × 30	0.50	9.33	4.71	B41231B3229M000
22000	30 × 25	0.50	9.56	4.83	B41231C3229M000
27000	22 × 45	0.50	10.49	5.30	B41231A3279M000
27000	25.4 × 35	0.50	10.41	5.26	B41231B3279M000
27000	30 × 30	0.50	10.71	5.41	B41231C3279M000
33000	22 × 50	0.50	11.52	5.82	B41231A3339M000
33000	25.4 × 40	0.50	11.50	5.81	B41231B3339M000
33000	30 × 30	0.50	11.27	5.69	B41231C3339M000
33000	35 × 25	0.50	11.50	5.81	B41231D3339M000
39000	25.4 × 45	0.50	12.49	6.31	B41231A3399M000
39000	30 × 35	0.50	12.32	6.22	B41231B3399M000
39000	35 × 30	0.50	12.63	6.38	B41231C3399M000
47000	25.4 × 50	0.50	13.52	6.83	B41231A3479M000
47000	30 × 40	0.50	13.42	6.78	B41231B3479M000
47000	35 × 30	0.50	13.11	6.62	B41231C3479M000
56000	30 × 45	0.50	14.47	7.31	B41231A3569M000
56000	35 × 35	0.50	14.22	7.18	B41231B3569M000
68000	35 × 40	0.50	15.36	7.76	B41231A3689M000
$V_R = 16 \text{ V DC}$					
10000	22 × 25	0.50	6.57	3.32	B41231A4109M000
12000	22 × 30	0.50	7.03	3.55	B41231A4129M000
12000	25.4 × 25	0.50	7.70	3.89	B41231B4129M000
15000	22 × 35	0.50	8.49	4.29	B41231A4159M000
15000	25.4 × 30	0.50	8.81	4.45	B41231B4159M000
15000	30 × 25	0.50	9.03	4.56	B41231C4159M000
18000	22 × 40	0.50	9.44	4.77	B41231A4189M000
18000	25.4 × 35	0.50	9.82	4.96	B41231B4189M000
18000	30 × 30	0.50	10.10	5.10	B41231C4189M000
22000	22 × 50	0.50	10.91	5.51	B41231A4229M000
22000	25.4 × 40	0.50	10.91	5.51	B41231B4229M000
22000	30 × 30	0.50	10.67	5.39	B41231C4229M000
27000	25.4 × 45	0.50	12.00	6.06	B41231A4279M000

B41231
Standard series – 85 °C
Technical data and ordering codes

C_R 120 Hz 20 °C μF	Case dimensions $d \times l$ mm	$\tan \delta_{\text{max}}$ 120 Hz 20 °C	$I_{\text{AC,max}}$ 120 Hz 60 °C A	$I_{\text{AC,R}}$ 120 Hz 85 °C A	Ordering code
$V_R = 16 \text{ V DC}$					
27000	30 × 35	0.50	11.84	5.98	B41231B4279M000
27000	35 × 25	0.50	11.48	5.80	B41231C4279M000
33000	30 × 40	0.50	12.99	6.56	B41231A4339M000
33000	35 × 30	0.50	12.69	6.41	B41231B4339M000
39000	30 × 45	0.50	14.02	7.08	B41231A4399M000
39000	35 × 35	0.50	13.78	6.96	B41231B4399M000
47000	30 × 50	0.50	15.09	7.62	B41231A4479M000
47000	35 × 40	0.50	14.93	7.54	B41231B4479M000
56000	35 × 45	0.50	16.00	8.08	B41231A4569M000
68000	35 × 50	0.50	16.89	8.53	B41231A4689M000
$V_R = 25 \text{ V DC}$					
5600	22 × 25	0.40	5.25	2.65	B41231A5568M000
6800	22 × 30	0.40	6.06	3.06	B41231A5688M000
6800	25.4 × 25	0.40	6.24	3.15	B41231B5688M000
8200	22 × 35	0.40	6.83	3.45	B41231A5828M000
8200	25.4 × 30	0.40	7.07	3.57	B41231B5828M000
10000	22 × 40	0.40	7.82	3.95	B41231A5109M000
10000	25.4 × 30	0.40	7.70	3.89	B41231B5109M000
12000	22 × 45	0.40	8.73	4.41	B41231A5129M000
12000	25.4 × 35	0.40	8.65	4.37	B41231B5129M000
12000	30 × 25	0.40	7.90	3.99	B41231C5129M000
15000	22 × 50	0.40	9.78	4.94	B41231A5159M000
15000	25.4 × 40	0.40	9.78	4.94	B41231B5159M000
15000	30 × 30	0.40	8.91	4.50	B41231C5159M000
18000	25.4 × 45	0.40	10.79	5.45	B41231A5189M000
18000	30 × 35	0.40	10.10	5.10	B41231B5189M000
22000	30 × 35	0.40	10.65	5.38	B41231A5229M000
22000	35 × 30	0.40	10.91	5.51	B41231B5229M000
27000	30 × 45	0.40	12.32	6.22	B41231A5279M000
27000	35 × 35	0.40	12.12	6.12	B41231B5279M000
33000	30 × 50	0.40	13.50	6.82	B41231A5339M000
33000	35 × 40	0.40	13.35	6.74	B41231B5339M000
39000	35 × 45	0.40	14.55	7.35	B41231A5399M000

Technical data and ordering codes

C_R 120 Hz 20 °C μF	Case dimensions $d \times l$ mm	$\tan \delta_{\max}$ 120 Hz 20 °C	$I_{AC,\max}$ 120 Hz 60 °C A	$I_{AC,R}$ 120 Hz 85 °C A	Ordering code
$V_R = 35 \text{ V DC}$					
4700	22 × 30	0.40	6.06	3.06	B41231A7478M000
4700	25.4 × 25	0.40	5.90	2.98	B41231B7478M000
5600	22 × 35	0.40	6.49	3.28	B41231A7568M000
5600	25.4 × 30	0.40	6.71	3.39	B41231B7568M000
6800	22 × 40	0.40	7.39	3.73	B41231A7688M000
6800	25.4 × 30	0.40	7.27	3.67	B41231B7688M000
6800	30 × 25	0.40	7.44	3.76	B41231C7688M000
8200	22 × 45	0.40	8.18	4.13	B41231A7828M000
8200	25.4 × 35	0.40	8.12	4.10	B41231B7828M000
8200	30 × 30	0.40	8.36	4.22	B41231C7828M000
10000	22 × 50	0.40	9.27	4.68	B41231A7109M000
10000	25.4 × 40	0.40	9.27	4.68	B41231B7109M000
10000	30 × 30	0.40	9.07	4.58	B41231C7109M000
12000	25.4 × 45	0.40	10.26	5.18	B41231A7129M000
12000	30 × 35	0.40	10.12	5.11	B41231C7129M000
12000	35 × 30	0.40	10.38	5.24	B41231D7129M000
15000	30 × 40	0.40	11.33	5.72	B41231A7159M000
15000	35 × 35	0.40	11.64	5.88	B41231B7159M000
18000	30 × 45	0.40	12.43	6.28	B41231A7189M000
18000	35 × 40	0.40	12.79	6.46	B41231B7189M000
22000	35 × 45	0.40	14.00	7.07	B41231A7229M000
$V_R = 50 \text{ V DC}$					
3300	22 × 30	0.30	5.88	2.97	B41231A6338M000
3300	25.4 × 25	0.30	7.58	3.06	B41231B6338M000
4700	22 × 40	0.30	7.58	3.83	B41231A6478M000
4700	25.4 × 35	0.30	7.88	3.98	B41231B6478M000
4700	30 × 25	0.30	7.64	3.86	B41231C6478M000
4700	35 × 25	0.30	8.30	4.19	B41231D6478M000
5600	22 × 45	0.30	8.43	4.26	B41231A6568M000
5600	25.4 × 40	0.30	8.79	4.44	B41231B6568M000
5600	30 × 30	0.30	8.61	4.35	B41231C6568M000
5600	35 × 25	0.30	8.79	4.44	B41231D6568M000
6800	22 × 50	0.30	9.44	4.77	B41231A6688M000
6800	25.4 × 45	0.30	9.42	4.76	B41231B6688M000
6800	30 × 35	0.30	9.74	4.92	B41231C6688M000
6800	35 × 30	0.30	9.98	5.04	B41231D6688M000
8200	25.4 × 50	0.30	10.75	5.43	B41231A6828M000
8200	30 × 40	0.30	10.65	5.38	B41231B6828M000

B41231
Standard series – 85 °C
Technical data and ordering codes

C_R 120 Hz 20 °C μF	Case dimensions $d \times l$ mm	$\tan \delta_{\max}$ 120 Hz 20 °C	$I_{AC,\max}$ 120 Hz 60 °C A	$I_{AC,R}$ 120 Hz 85 °C A	Ordering code
$V_R = 50 \text{ V DC}$					
8200	35 × 30	0.30	10.41	5.26	B41231C6828M000
10000	30 × 45	0.30	12.02	6.07	B41231A6109M000
10000	35 × 35	0.30	11.82	5.97	B41231B6109M000
12000	30 × 50	0.30	13.11	6.62	B41231A6129M000
12000	35 × 40	0.30	12.97	6.55	B41231B6129M000
15000	35 × 45	0.30	14.26	7.20	B41231A6159M000
18000	35 × 50	0.30	15.33	7.74	B41231A6189M000
$V_R = 63 \text{ V DC}$					
1800	22 × 25	0.25	4.36	2.20	B41231A8188M000
2200	22 × 30	0.25	4.95	2.50	B41231A8228M000
2200	25.4 × 25	0.25	5.11	2.58	B41231B8228M000
2700	22 × 35	0.25	5.82	2.94	B41231A8278M000
2700	25.4 × 30	0.25	6.02	3.04	B41231B8278M000
3300	22 × 35	0.25	6.22	3.14	B41231A8338M000
3300	25.4 × 30	0.25	6.45	3.26	B41231B8338M000
3300	30 × 25	0.25	6.61	3.34	B41231C8338M000
3900	22 × 40	0.25	7.13	3.60	B41231A8398M000
3900	25.4 × 35	0.25	7.41	3.74	B41231B8398M000
3900	30 × 30	0.25	7.62	3.85	B41231C8398M000
4700	22 × 50	0.25	8.30	4.19	B41231A8478M000
4700	25.4 × 40	0.25	8.30	4.19	B41231B8478M000
4700	30 × 35	0.25	8.12	4.10	B41231C8478M000
4700	35 × 30	0.25	8.30	4.19	B41231D8478M000
5600	25.4 × 45	0.25	9.21	4.65	B41231A8568M000
5600	30 × 35	0.25	9.07	4.58	B41231B8568M000
5600	35 × 30	0.25	9.31	4.70	B41231C8568M000
6800	25.4 × 50	0.25	10.30	5.20	B41231A8688M000
6800	30 × 40	0.25	10.22	5.16	B41231B8688M000
6800	35 × 30	0.25	9.98	5.04	B41231C8688M000
8200	30 × 45	0.25	11.13	5.62	B41231A8828M000
8200	35 × 35	0.25	10.95	5.53	B41231B8828M000
10000	30 × 50	0.25	12.51	6.32	B41231A8109M000
10000	35 × 40	0.25	12.38	6.25	B41231B8109M000
12000	35 × 45	0.25	13.52	6.83	B41231A8129M000

Technical data and ordering codes

C_R 120 Hz 20 °C μF	Case dimensions $d \times l$ mm	$\tan \delta_{\max}$ 120 Hz 20 °C	$I_{AC,\max}$ 120 Hz 60 °C A	$I_{AC,R}$ 120 Hz 85 °C A	Ordering code
$V_R = 80 \text{ V DC}$					
1200	22 × 25	0.20	4.44	2.24	B41231A0128M000
1500	22 × 30	0.20	5.29	2.67	B41231A0158M000
1800	22 × 30	0.20	5.78	2.92	B41231A0188M000
1800	25.4 × 25	0.20	5.96	3.01	B41231B0188M000
2200	22 × 35	0.25	6.44	3.25	B41231A0228M000
2200	25.4 × 30	0.20	6.65	3.36	B41231B0228M000
2200	30 × 25	0.20	6.83	3.45	B41231C0228M000
2700	22 × 40	0.20	7.50	3.79	B41231A0278M000
2700	25.4 × 35	0.20	7.80	3.94	B41231B0278M000
2700	30 × 30	0.20	8.02	4.05	B41231C0278M000
3300	22 × 45	0.20	8.28	4.18	B41231A0338M000
3300	25.4 × 40	0.20	8.63	4.36	B41231B0338M000
3300	30 × 30	0.20	8.45	4.27	B41231C0338M000
3900	22 × 50	0.25	9.41	4.75	B41231A0398M000
3900	25.4 × 45	0.20	9.82	4.96	B41231B0398M000
3900	30 × 35	0.20	9.68	4.89	B41231C0398M000
4700	25.4 × 50	0.20	10.77	5.44	B41231A0478M000
4700	30 × 40	0.20	10.67	5.39	B41231B0478M000
4700	35 × 30	0.20	10.43	5.27	B41231C0478M000
5600	30 × 45	0.20	11.70	5.91	B41231A0568M000
5600	35 × 35	0.20	11.50	5.81	B41231B0568M000
6800	35 × 40	0.20	10.81	5.46	B41231A0688M000
8200	35 × 45	0.20	13.68	6.91	B41231A0828M000
$V_R = 100 \text{ V DC}$					
1200	22 × 30	0.15	4.73	2.39	B41231A9128M000
1200	25.4 × 25	0.15	4.87	2.46	B41231B9128M000
1500	22 × 35	0.15	5.60	2.83	B41231A9158M000
1500	25.4 × 30	0.15	5.80	2.93	B41231B9158M000
1500	30 × 25	0.15	5.94	3.00	B41231C9158M000
1800	22 × 40	0.15	6.45	3.26	B41231A9188M000
1800	25.4 × 35	0.15	6.71	3.39	B41231B9188M000
1800	30 × 30	0.15	6.91	3.49	B41231C9188M000
2200	22 × 45	0.15	7.09	3.58	B41231A9228M000
2200	25.4 × 40	0.15	7.41	3.74	B41231B9228M000



B41231

Standard series – 85 °C

Technical data and ordering codes

C_R 120 Hz 20 °C μF	Case dimensions $d \times l$ mm	$\tan \delta_{\max}$ 120 Hz 20 °C	$I_{AC,\max}$ 120 Hz 60 °C A	$I_{AC,R}$ 120 Hz 85 °C A	Ordering code
$V_R = 100 \text{ V DC}$					
2200	30 × 30	0.15	7.25	3.66	B41231C9228M000
2700	25.4 × 45	0.15	8.57	4.33	B41231A9278M000
2700	30 × 35	0.15	8.45	4.27	B41231B9278M000
2700	35 × 30	0.15	8.65	4.37	B41231C9278M000
3300	25.4 × 50	0.15	9.42	4.76	B41231A9338M000
3300	30 × 40	0.15	9.35	4.72	B41231B9338M000
3300	35 × 35	0.15	9.60	4.85	B41231C9338M000
3900	30 × 45	0.15	10.61	5.36	B41231A9398M000
3900	35 × 35	0.15	10.43	5.27	B41231B9398M000
4700	30 × 50	0.15	11.60	5.86	B41231A9478M000
4700	35 × 40	0.15	11.48	5.80	B41231B9478M000
5600	35 × 45	0.15	12.55	6.34	B41231A9568M000

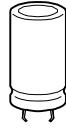

Useful life

depending on ambient temperature T_A under ripple current operating conditions¹⁾

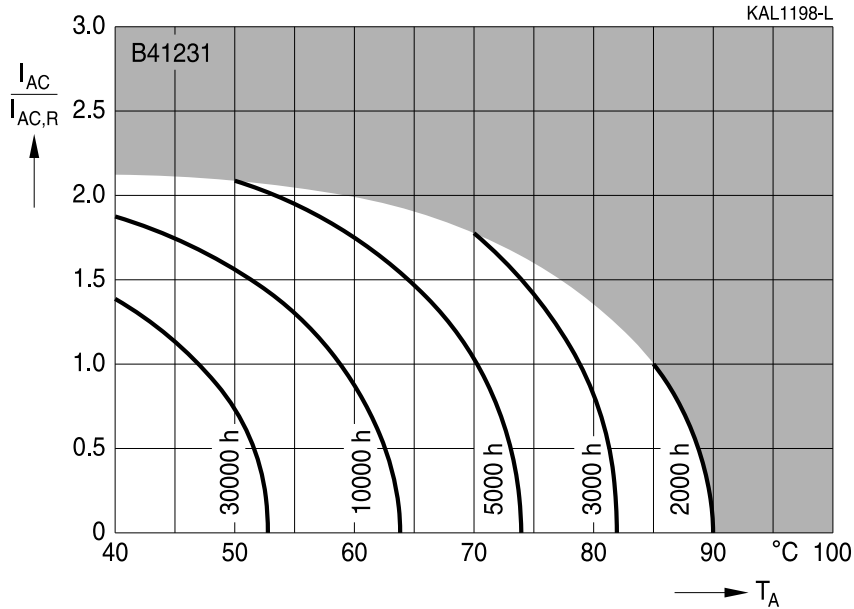

Frequency factor of permissible ripple current I_{AC} versus frequency f

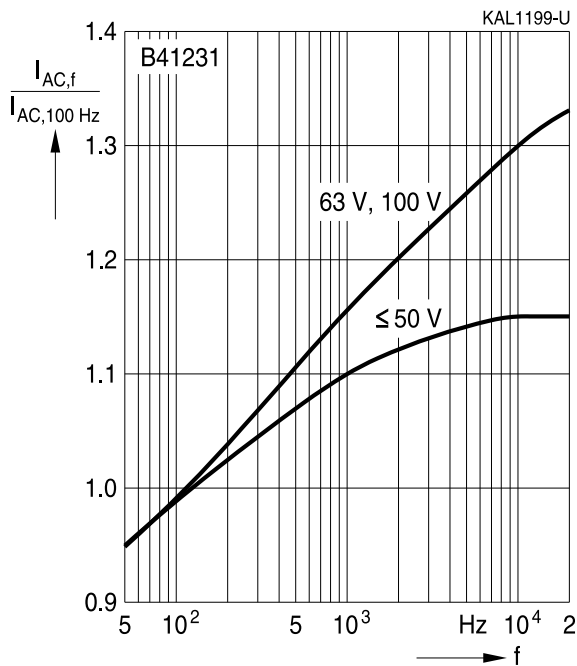

Frequency characteristics of ESR
Typical behavior

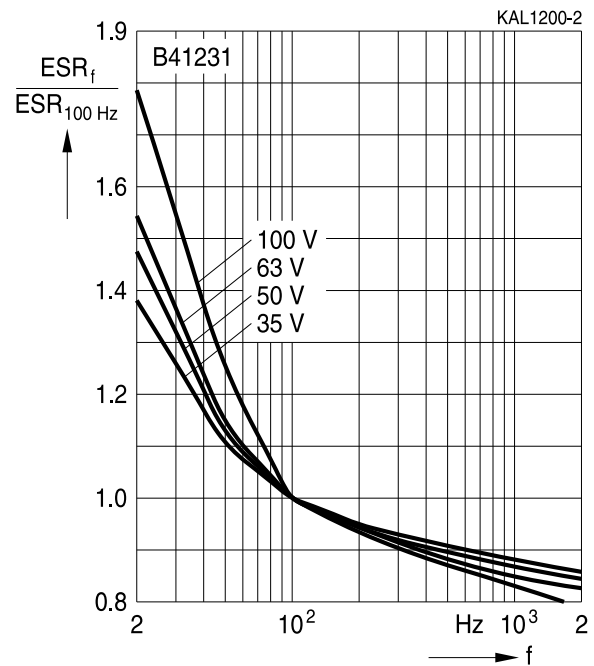

1) Refer to chapter "General technical information, 5.3 Calculation of useful life" for an explanation on how to interpret the useful life graphs.

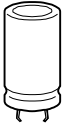

B41231

Standard series – 85 °C

Impedance Z versus frequency f

Typical behavior at 20 °C

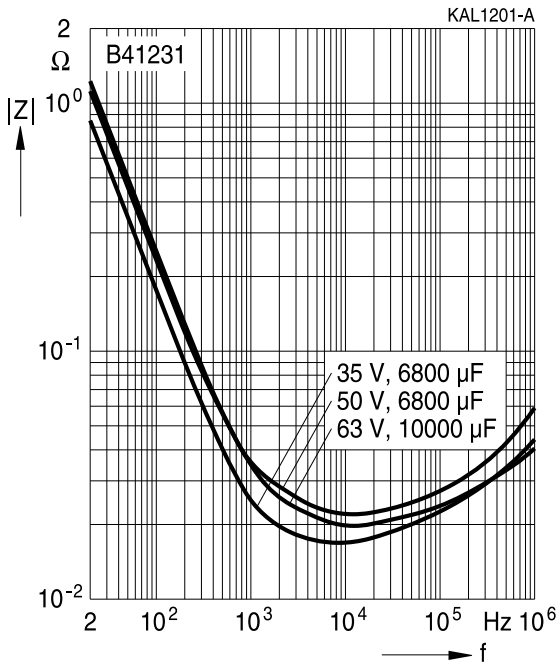



Cautions and warnings

Personal safety

The electrolytes used by EPCOS have not only been optimized with a view to the intended application, but also with regard to health and environmental compatibility. They do not contain any solvents that are detrimental to health, e.g. dimethyl formamide (DMF) or dimethyl acetamide (DMAC).

Furthermore, part of the high-voltage electrolytes used by EPCOS are self-extinguishing. They contain flame-retarding substances which will quickly extinguish any flame that may have been ignited.

As far as possible, EPCOS does not use any dangerous chemicals or compounds to produce operating electrolytes. However, in exceptional cases, such materials must be used in order to achieve specific physical and electrical properties because no safe substitute materials are currently known. However, the amount of dangerous materials used in our products has been limited to an absolute minimum. Nevertheless, the following rules should be observed when handling Al electrolytic capacitors:

- Any escaping electrolyte should not come into contact with eyes or skin.
- If electrolyte does come into contact with the skin, wash the affected parts immediately with running water. If the eyes are affected, rinse them for 10 minutes with plenty of water. If symptoms persist, seek medical treatment.
- Avoid breathing in electrolyte vapor or mists. Workplaces and other affected areas should be well ventilated. Clothing that has been contaminated by electrolyte must be changed and rinsed in water.

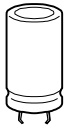

B41231

Standard series – 85 °C

Product safety

The table below summarize the safety instructions that must be observed without fail. A detailed description can be found in the relevant sections of chapter "General technical information".

Topic	Safety information	Reference Chapter "General technical information"
Polarity	Make sure that polar capacitors are connected with the right polarity.	1 "Basic construction of aluminum electrolytic capacitors"
Reverse voltage	Voltages polarity classes should be prevented by connecting a diode.	3.1.6 "Reverse voltage"
Upper category temperature	Do not exceed the upper category temperatur.	7.2 "Maximum permissible operating temperature"
Maintenance	Make periodic inspections of the capacitors. Before the inspection, make sure that the power supply is turned off and carefully discharge the electricity of the capacitors. Do not apply any mechanical stress to the capacitor terminals.	10 "Maintenance"
Mounting position of screw terminal capacitors	Do not mount the capacitor with the terminals (safety vent) upside down.	11.1 "Mounting positions of capacitors with screw terminals"
Mounting of single-ended capacitors	The internal structure of single-ended capacitors might be damaged if excessive force is applied to the lead wires. Avoid any compressive, tensile or flexural stress. Do not move the capacitor after soldering to PC board. Do not pick up the PC board by the soldered capacitor. Do not insert the capacitor on the PC board with a hole space different to the lead space specified.	11.4 "Mounting considerations for single-ended capacitors"
Robustness of terminals	The following maximum tightening torques must not be exceeded when connecting screw terminals: M5: 2 Nm M6: 2.5 Nm	11.3 "Mounting torques"
Soldering	Do not exceed the specified time or temperature limits during soldering.	11.5 "Soldering"

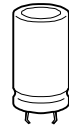

Topic	Safety information	Reference Chapter "General technical information"
Soldering, cleaning agents	Do not allow halogenated hydrocarbons to come into contact with aluminum electrolytic capacitors.	11.6 "Cleaning agents"
Passive flammability	Avoid external energy, such as fire or electricity.	8.1 "Passive flammability"
Active flammability	Avoid overload of the capacitors.	8.2 "Active flammability"
		Reference Chapter "Capacitors with screw terminals"
Breakdown strength of insulating sleeves	Do not damage the insulating sleeve, especially when ring clips are used for mounting.	"Screw terminals - accessories"

B41231
Standard series – 85 °C

Symbols and terms

Symbol	English	German
C	Capacitance	Kapazität
C_R	Rated capacitance	Nennkapazität
C_S	Series capacitance	Serienkapazität
$C_{S,T}$	Series capacitance at temperature T	Serienkapazität bei Temperatur T
C_f	Capacitance at frequency f	Kapazität bei Frequenz f
d	Case diameter, nominal dimension	Gehäusedurchmesser, Nennmaß
d_{max}	Maximum case diameter	Maximaler Gehäusedurchmesser
ESL	Self-inductance	Eigeninduktivität
ESR	Equivalent series resistance	Ersatzserienwiderstand
ESR_f	Equivalent series resistance at frequency f	Ersatzserienwiderstand bei Frequenz f
ESR_T	Equivalent series resistance at temperature T	Ersatzserienwiderstand bei Temperatur T
f	Frequency	Frequenz
I	Current	Strom
I_{AC}	Alternating current (ripple current)	Wechselstrom
$I_{AC,rms}$	Root-mean-square value of alternating current	Wechselstrom, Effektivwert
$I_{AC,f}$	Ripple current at frequency f	Wechselstrom bei Frequenz f
$I_{AC,max}$	Maximum permissible ripple current	Maximal zulässiger Wechselstrom
$I_{AC,R}$	Rated ripple current	Nennwechselstrom
$I_{AC,R} (B)$	Rated ripple current for base cooling	Nennwechselstromstrom für Bodenkühlung
I_{leak}	Leakage current	Ableitstrom
$I_{leak,op}$	Operating leakage current	Ableitstrom bei Betrieb
l	Case length, nominal dimension	Gehäuselänge, Nennmaß
l_{max}	Maximum case length (without terminals and mounting stud)	Maximale Gehäuselänge (ohne Anschlüsse und Gewindebolzen)
R	Resistance	Widerstand
R_{ins}	Insulation resistance	Isolationswiderstand
R_{symm}	Balancing resistance	Symmetrierwiderstand
T	Temperature	Temperatur
ΔT	Temperature difference	Temperaturdifferenz
T_A	Ambient temperature	Umgebungstemperatur
T_C	Case temperature	Gehäusetemperatur
T_B	Capacitor base temperature	Temperatur des Becherbodens
t	Time	Zeit
Δt	Period	Zeitraum
t_b	Service life (operating hours)	Brauchbarkeitsdauer (Betriebszeit)



Symbol	English	German
V	Voltage	Spannung
V _F	Forming voltage	Formierspannung
V _{op}	Operating voltage	Betriebsspannung
V _R	Rated voltage, DC voltage	Nennspannung, Gleichspannung
V _S	Surge voltage	Spitzenspannung
X _C	Capacitive reactance	Kapazitiver Blindwiderstand
X _L	Inductive reactance	Induktiver Blindwiderstand
Z	Impedance	Scheinwiderstand
Z _T	Impedance at temperature T	Scheinwiderstand bei Temperatur T
tan δ	Dissipation factor	Verlustfaktor
λ	Failure rate	Ausfallrate
ε ₀	Absolute permittivity	Elektrische Feldkonstante
ε _r	Relative permittivity	Dielektrizitätszahl
ω	Angular velocity; 2 · π · f	Kreisfrequenz; 2 · π · f

Notes

All dimensions are given in mm.

Important notes

The following applies to all products named in this publication:

1. Some parts of this publication contain **statements about the suitability of our products for certain areas of application**. These statements are based on our knowledge of typical requirements that are often placed on our products in the areas of application concerned. We nevertheless expressly point out **that such statements cannot be regarded as binding statements about the suitability of our products for a particular customer application**. As a rule, EPCOS is either unfamiliar with individual customer applications or less familiar with them than the customers themselves. For these reasons, it is always ultimately incumbent on the customer to check and decide whether an EPCOS product with the properties described in the product specification is suitable for use in a particular customer application.
2. We also point out that **in individual cases, a malfunction of electronic components or failure before the end of their usual service life cannot be completely ruled out in the current state of the art, even if they are operated as specified**. In customer applications requiring a very high level of operational safety and especially in customer applications in which the malfunction or failure of an electronic component could endanger human life or health (e.g. in accident prevention or lifesaving systems), it must therefore be ensured by means of suitable design of the customer application or other action taken by the customer (e.g. installation of protective circuitry or redundancy) that no injury or damage is sustained by third parties in the event of malfunction or failure of an electronic component.
3. **The warnings, cautions and product-specific notes must be observed.**
4. In order to satisfy certain technical requirements, **some of the products described in this publication may contain substances subject to restrictions in certain jurisdictions (e.g. because they are classed as hazardous)**. Useful information on this will be found in our Material Data Sheets on the Internet (www.epcos.com/material). Should you have any more detailed questions, please contact our sales offices.
5. We constantly strive to improve our products. Consequently, **the products described in this publication may change from time to time**. The same is true of the corresponding product specifications. Please check therefore to what extent product descriptions and specifications contained in this publication are still applicable before or when you place an order. We also **reserve the right to discontinue production and delivery of products**. Consequently, we cannot guarantee that all products named in this publication will always be available. The aforementioned does not apply in the case of individual agreements deviating from the foregoing for customer-specific products.
6. Unless otherwise agreed in individual contracts, **all orders are subject to the current version of the "General Terms of Delivery for Products and Services in the Electrical Industry" published by the German Electrical and Electronics Industry Association (ZVEI)**.
7. The trade names EPCOS, BAOKE, Alu-X, CeraDiode, CSSP, CTVS, DSSP, MiniBlue, MKK, MLSC, MotorCap, PCC, PhaseCap, PhaseMod, SIFERRIT, SIFI, SIKOREL, SilverCap, SIMDAD, SIMID, SineFormer, SIOV, SIP5D, SIP5K, ThermoFuse, WindCap are **trademarks registered or pending** in Europe and in other countries. Further information will be found on the Internet at www.epcos.com/trademarks.