

PRODUCT NUMBER
SEE TABLE

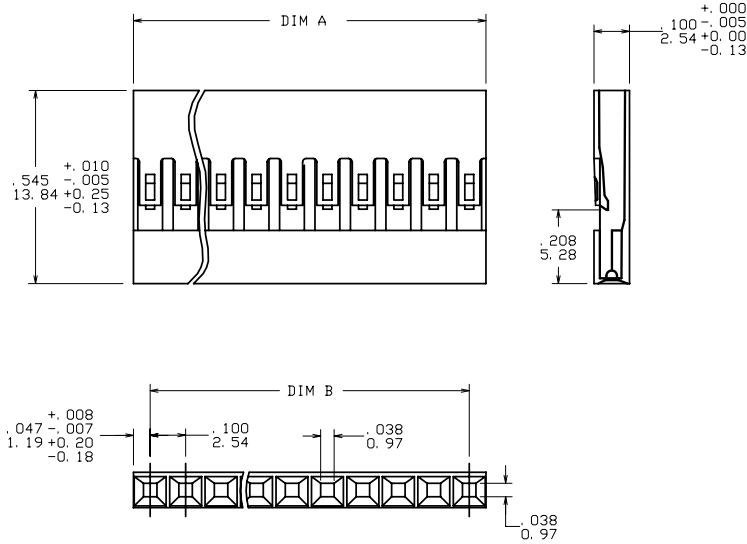

CONFIGURATION 1
(WITHOUT RIB)

NOTES:

- ① MOLDING MATERIAL: MODIFIED POLYPHENYLENE ETHER, COLOR: BLACK, UL 94V-0.
2. PIN LENGTH TO BE .210/5.33 MIN RECOMMENDED PIN LENGTH IS .225/5.72 ± .015/0.38.
3. FOR TERMINAL APPLICATION SEE TA-531. PRODUCT SPECIFICATION: BUS-12-067.
4. TERMINALS MUST BE CRIMPED PROPERLY FOR SATISFACTORY LATCHING. SEE TA-75 FOR CRIMPING INSTRUCTIONS.
5. THIS HOUSING IS INTENDED FOR USE WITH MINI PVM TERMINAL WITH 22-36 GAUGE WIRE.
- ⑥ ALL MARKING EXCEPT LOGO DONE IN "6 POINT TYPE SET" IF SPACE PERMITS APPROX AREA PER NUMBER/LETTER .056/1.42 WIDE X .06/1.5 HIGH USING WHITE PERMANENT INK.
- ⑦ ALL MARKINGS FOR MILITARY PART NUMBERS ARE TO BE PER MIL-STD-1285. SEE TABULATION.
- ⑧ PLACE DESC P/N AND CAGE NO. ON PACKAGING LABEL. PRODUCT LENGTH IS TOO SMALL TO MARK PART.
- ⑨ THESE PARTS ARE AS MOLDED WITH NO MARKINGS AND NO RESTRICTIONS, (BUT ARE MARKETABLE).
10. PRODUCT MEETS EUROPEAN UNION DIRECTIVES AND OTHER COUNTRY REGULATIONS AS DESCRIBED IN GS-22-008.
11. THE PRODUCT IS NOT INTENDED TO BE EXPOSED TO MANUFACTURING SOLDER PROCESS.
- ⑫ EUROPEAN CUSTOMERS SHOULD ORDER PART NUMBERS WITH AN 'E' SUFFIX AS SHOWN IN TABLE TO CONTINUE TO BE SUPPLIED BY THE EUROPEAN PLANT. SEE DRAWING 65039EUR.

mat'l code	SEE NOTE 1	surface	tolerance	projection	product family
lfr	ec'n no	dr	date	ASME Y14.5 ✓ ASME Y14.5	PV HOUSINGS
BE	v07-0483	HTB	2007-07-24	tolerances unless otherwise specified	title
-	-	-	-	angles	MINI LATCH HOUSING
AY	v03-1356	PJ	2004-01-31	0°±2'	SINGLE ROW .100 [2.54] CC
BA	v05-0712	DAI	2005-07-27	dr	scale 3:1
BB	v06-0407	HTB	2006-04-26	engr	FCJ
BC	v06-0549	HTB	2006-06-12	chr	dwg no
BD	v06-0886	HTB	2006-08-31	appd	65039
sheet	revision	BE	BE	BE	sheet 1 of 12
index	sheet	1	2	3	A4
		4	5	6	Product Customer Drawing
		7	8	9	
		10	11	12	



1 | 2

3

4

PRODUCT NUMBER
SEE TABLE

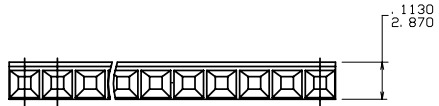
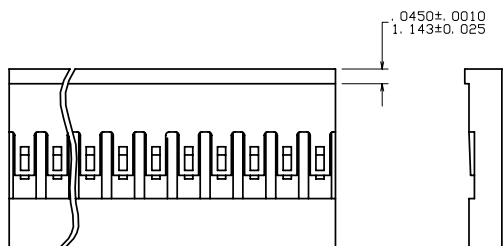

CONFIGURATION 2
(WITH RIB)

mat'l. code		SEE NOTE 1		surface	tolerance	projection	product family
ltr		ec'n no	dr	date	ASME Y14.5 ✓	ASME Y14.5	PV HOUSINGS
BE					tolerances unless otherwise specified	INCH/MM	title
					angles	XXX+01/XX+3	MINI LATCH HOUSING
					0°±2'	XXXX+005/XXX+13	SINGLE ROW .100 [2.54] CC
					dr	XXXX+0020/XXX+051	scale 3:1
					dr	M. CORNMAN	1990-01-31
					engr	H. SUNDY	1990-01-31
					chr	H. SUNDY	1990-01-31
					appd	H. SUNDY	1990-01-31
sheet	revision						
index	sheet						
							dwg no
							65039
							sheet 2 of 12
							size
							A4
							type
							Product Customer Drawing

form: A4mmXLC

1



2

3

4

<p>PRODUCT NO SEE TABLE</p> <p>MARK CO. LOGO TRADEMARK & PART NO. & CAVITY NO. APPROX. AS SHOWN.</p> <p>STYLE A</p>	<p>MARK CUST NAME AND CAVITY NO. APPROX AS SHOWN.</p> <p>STYLE D</p>	<p>CO. LOGO, CUSTOMER PART NO. LOGO, CUSTOMER PART NO. FIRST AND LAST CAVITIES AND EVERY FIFTH CAVITY MARKED PERMANENTLY AND LEGIBLE IN WHITE INK APPROX AS SHOWN.</p> <p>STYLE G</p>	<p>STYLE K</p>
<p>MARK CO. LOGO TRADEMARK & PART NO. & CAVITY NO. APPROX. AS SHOWN.</p> <p>STYLE B</p>	<p>MARK NUMBERS AS SHOWN CHARACTERS TO BE PERMANENT AND LEGIBLE AFTER REACHING #9 CAVITY CONTINUE ONLY MARKING EVERY OTHER ONE; IE. #11, #13, #15 ETC.</p> <p>STYLE E</p>	<p>MARK CHARACTERS AS SHOWN (ONE SIDE ONLY) 1,5,10,15, 20,ETC.</p> <p>STYLE H</p>	<p>MARK CHARACTERS AS SHOWN IN WHITE (ONE SIDE ONLY)</p> <p>STYLE L</p>
<p>MARK LETTERS AS SHOWN CHARACTERS TO BE PERMANENT & LEGIBLE. OMIT (!) POS AS SHOWN</p> <p>STYLE C</p>	<p>MARK ARROW IN WHITE APPROX AS SHOWN.</p> <p>STYLE F</p>	<p>NOTE 6</p> <p>STYLE J</p>	

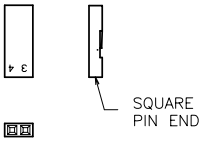
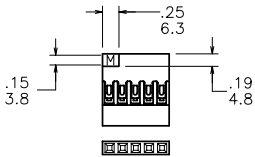
mat'l. code	SEE NOTE 1	surface	tolerance	projection	product family
tr	ecn no	date	ASME Y14.5 ✓ ASME Y14.5		PV HOUSINGS
BE			tolerances unless otherwise specified	INCH/MM	title
			angles	scale 1:1	MINI LATCH HOUSING SINGLE ROW .100 [2.54] CC
			0'±2'		dwg no 65039 sheet 3 of 12 size A4
			dr M. CORNMAN 1990-01-31		type Product Customer Drawing
			enrg H. SUNDY 1990-01-31		
			chr H. SUNDY 1990-01-31		
			appd H. SUNDY 1990-01-31		
sheet index	revision sheet				

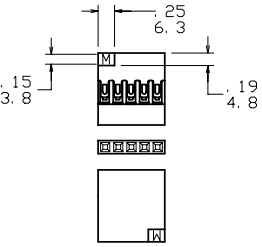
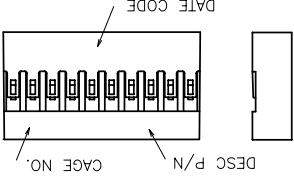
<p>PRODUCT NO SEE TABLE</p>	<p>MARK CHARACTERS ON SIDE OPPOSITE THE LATCHES ON THE PLUGGABLE SQUARE PIN END</p>	<p>MARK AN M (BLACK) IN THE CORNER AS SHOWN, WITH A WHITE BACKGROUND.</p>
 <p>STYLE M</p>	 <p>SQUARE PIN END</p> <p>STYLE P</p>	 <p>STYLE S</p>
<p>CAVITY MARKED WITH ARROW</p>  <p>STYLE N</p>	<p>MARK AN M (BLACK) IN THE CORNER AS SHOWN, WITH A WHITE BACKGROUND, ON BOTH SIDES OF THE PART.</p>  <p>STYLE R</p>	 <p>DATE CODE</p> <p>CAGE NO.</p> <p>DESC P/N</p> <p>STYLE T NOTE-7 & 8</p>

mat'l. code	SEE NOTE 1	surface	tolerance	projection	product family
lfr	ecrn no	dr	date	ASME Y14.5 ✓ ASME Y14.5	PV HOUSINGS
BE				tolerances unless otherwise specified	title
				angles	MINI LATCH HOUSING
				finishes	SINGLE ROW .100 [2.54] CC
				0°±2'	dwg no
				XXX+01/XX+3	65039
				XXX+005/XX+8	sheet 4 of 12
				XXXX+0020/XXX+051	size
				scale 1:1	A4
				dr M. CORNMAN 1990-01-31	type
				engr H. SUNDY 1990-01-31	Product Customer Drawing
				chr H. SUNDY 1990-01-31	
				appd H. SUNDY 1990-01-31	
sheet index	revision sheet				

Copyright FCJ



FCJconnect.com

PRODUCT NO.	NO.OF POS.	DIM A MAX	DIM B	EUROPEAN VERSION-NOTE 12	CONFIGURATION
65039-001LF	36	3.600/91.44	3.500/88.90	65039-001ELF	1
65039-002LF	35	3.500/88.90	3.400/86.36	65039-002ELF	1
65039-003LF	34	3.400/86.36	3.300/83.82	65039-003ELF	1
65039-004LF	33	3.300/83.82	3.200/81.28	65039-004ELF	1
65039-005LF	32	3.200/81.28	3.100/78.74	65039-005ELF	1
65039-006LF	31	3.100/78.74	3.000/76.20	65039-006ELF	1
65039-007LF	30	3.000/76.20	2.900/73.66	65039-007ELF	1
65039-008LF	29	2.900/73.66	2.800/71.12	65039-008ELF	1
65039-009LF	28	2.800/71.12	2.700/68.58	65039-009ELF	1
65039-010LF	27	2.700/68.58	2.600/66.04	65039-010ELF	1
65039-011LF	26	2.600/66.04	2.500/63.50	65039-011ELF	1
65039-012LF	25	2.500/63.50	2.400/60.96	65039-012ELF	1
65039-013LF	24	2.400/60.96	2.300/58.24	65039-013ELF	1
65039-014LF	23	2.300/58.24	2.200/55.88	65039-014ELF	1
65039-015LF	22	2.200/55.88	2.100/53.34	65039-015ELF	1
65039-016LF	21	2.100/53.34	2.000/50.80	65039-016ELF	1
65039-017LF	20	2.000/50.80	1.900/48.26	65039-017ELF	1
65039-018LF	19	1.900/48.26	1.800/45.72	65039-018ELF	1
65039-019LF	18	1.800/45.72	1.700/43.18	65039-019ELF	1
65039-020LF	17	1.700/43.18	1.600/40.64	65039-020ELF	1
65039-021LF	16	1.600/40.64	1.500/38.10	65039-021ELF	1
65039-022LF	15	1.500/38.10	1.400/35.56	65039-022ELF	1
65039-023LF	14	1.400/35.56	1.300/33.02	65039-023ELF	1
65039-024LF	13	1.300/33.02	1.200/30.48	65039-024ELF	1
65039-025LF	12	1.200/30.48	1.100/27.94	65039-025ELF	1
65039-026LF	11	1.100/27.94	1.000/25.40	65039-026ELF	1
65039-027LF	10	1.000/25.40	.900/22.86	65039-027ELF	1
65039-028LF	9	.900/22.86	.800/20.32	65039-028ELF	1
65039-029LF	8	.800/20.32	.700/17.78	65039-029ELF	1
65039-030LF	7	.700/17.78	.600/15.24	65039-030ELF	1
65039-031LF	6	.600/15.24	.500/12.70	65039-031ELF	1
65039-032LF	5	.500/12.70	.400/10.16	65039-032ELF	1
65039-033LF	4	.400/10.16	.300/7.62	65039-033ELF	1
65039-034LF	3	.300/7.62	.200/5.08	65039-034ELF	1
65039-035LF	2	.200/5.08	.100/2.54	65039-035ELF	1
65039-036LF	1	.100/2.54	—	—	1

mat'l. code	SEE NOTE 1	surface	tolerance	projection	product family
lfr	ecrn no	ASME Y14.5 ✓	ASME Y14.5		PV HOUSINGS
BE		tolerances unless otherwise specified	XX±01/XX±3	INCH/MM	title
		angles	XXX±005/XXX±13	scale 3:1	MINI LATCH HOUSING
		0°±2'	XXXX±0020/XXX±051		SINGLE ROW .100 [2.54] CC
		dr	M. CORNMAN 1990-01-31		dwg no
		engr	H. SUNDY 1990-01-31		sheet 5 of 12
		chr	H. SUNDY 1990-01-31		65039
		appd	H. SUNDY 1990-01-31		size A4
sheet index	revision sheet				type Product Customer Drawing

form A4mmXLC

Copyright FCJ



FCJconnect.com

1 | 2

3 |

4

MILITARY PRODUCT NO.	MADE FROM	MARKING STYLE	DESC P/N	CAGE NO.	REMARKS
65039-001-MIL	65039-001	T	86060-36	22526	OBSOLETE
65039-002-MIL	65039-002	T	86060-35	22526	OBSOLETE
65039-003-MIL	65039-003	T	86060-34	22526	OBSOLETE
65039-004-MIL	65039-004	T	86060-33	22526	OBSOLETE
65039-005-MIL	65039-005	T	86060-32	22526	OBSOLETE
65039-006-MIL	65039-006	T	86060-31	22526	OBSOLETE
65039-007-MIL	65039-007	T	86060-30	22526	OBSOLETE
65039-008-MIL	65039-008	T	86060-29	22526	OBSOLETE
65039-009-MIL	65039-009	T	86060-28	22526	OBSOLETE
65039-010-MIL	65039-010	T	86060-27	22526	OBSOLETE
65039-011-MIL	65039-011	T	86060-26	22526	OBSOLETE
65039-012-MIL	65039-012	T	86060-25	22526	OBSOLETE
65039-013-MIL	65039-013	T	86060-24	22526	OBSOLETE
65039-014-MIL	65039-014	T	86060-23	22526	OBSOLETE
65039-015-MIL	65039-015	T	86060-22	22526	OBSOLETE
65039-016-MIL	65039-016	T	86060-21	22526	OBSOLETE
65039-017-MIL	65039-017	T	86060-20	22526	OBSOLETE
65039-018-MIL	65039-018	T	86060-19	22526	OBSOLETE
65039-019-MIL	65039-019	T	86060-18	22526	OBSOLETE
65039-020-MIL	65039-020	T	86060-17	22526	OBSOLETE
65039-021-MIL	65039-021	T	86060-16	22526	OBSOLETE
65039-022-MIL	65039-022	T	86060-15	22526	OBSOLETE
65039-023-MIL	65039-023	T	86060-14	22526	OBSOLETE
65039-024-MIL	65039-024	T	86060-13	22526	OBSOLETE
65039-025-MIL	65039-025	T	86060-12	22526	OBSOLETE
65039-026-MIL	65039-026	T	86060-11	22526	OBSOLETE
65039-027-MIL	65039-027	T	86060-10	22526	OBSOLETE
65039-028-MIL	65039-028	T	86060-09	22526	SEE NOTE 8
65039-029-MIL	65039-029	T	86060-08	22526	SEE NOTE 8
65039-030-MIL	65039-030	T	86060-07	22526	SEE NOTE 8
65039-031-MIL	65039-031	T	86060-06	22526	SEE NOTE 8
65039-032-MIL	65039-032	T	86060-05	22526	SEE NOTE 8
65039-033-MIL	65039-033	T	86060-04	22526	SEE NOTE 8
65039-034-MIL	65039-034	T	86060-03	22526	SEE NOTE 8
65039-035-MIL	65039-035	T	86060-02	22526	SEE NOTE 8
65039-036-MIL	65039-036	T	86060-01	22526	SEE NOTE 8

mat'l code		SEE NOTE 1		surface ASME Y14.5 ✓		tolerance ASME Y14.5		projection		product family PV HOUSINGS	
ltr	ecrn no	dr	date	tolerances unless otherwise specified							
BE				angles	fin	xxx+01/xx+3	INCH/MM		title		
				0'±2'		xxx+005/xx+3	scale 1:1		MINI LATCH HOUSING		
						xxxx+0020/xxx+051	FCJ		SINGLE ROW .100 [2.54] CC		
				dr	M. CORNMAN	1990-01-31			dwg no		
				engr	H. SUNDY	1990-01-31			sheet 6 of 12 size		
				chr	H. SUNDY	1990-01-31			65039 A4		
				appd	H. SUNDY	1990-01-31			type Product Customer Drawing		
sheet index	revision sheet										

form A4mmXlc

1 | 2

3 |

4

Copyright FCJ



FCJconnect.com

1 | 2

3 |

4

PRODUCT NO	NO.OF POS.	DIM A MAX	DIM B	SPECIAL MARKINGS	CUSTOMER RESTRICTED	CONFIGURATION
65039-037LF	8	.800/20.32	.700/17.78	STYLE A		1
65039-038LF	8	.800/20.32	.700/17.78	B		↑
65039-039LF	10	1.000/25.40	.900/22.86	C		
65039-040LF	5	.500/12.70	.400/10.16	C		
65039-041LF	8	.800/20.32	.700/17.78	D	X	
65039-042LF	8	.800/20.32	.700/17.78	E		
65039-043LF	6	.600/15.24	.500/12.70	E		
65039-044LF	10	1.000/25.40	.900/22.86	A		
65039-045LF	4	.400/10.16	.300/7.62	A		
65039-046LF	9	.900/22.86	.800/20.32	A		
65039-047LF	7	.700/17.78	.600/15.24	A		
65039-048LF	20	2.000/50.80	1.900/48.26	A		
65039-049LF	3	.300/7.62	.200/5.08	C		
65039-050LF	8	.800/20.32	.700/17.78	F		
65039-051LF	16	1.600/40.64	1.500/38.10	F		
65039-052LF	20	2.000/50.80	1.900/48.26	F		
65039-053LF	24	2.400/60.96	2.300/58.24	F		
65039-054LF	19	1.900/48.26	1.800/45.72	E		
65039-055LF	33	3.300/83.82	3.200/81.28	E		
65039-056LF	7	.700/17.78	.600/15.24	E		
65039-057LF	4	.400/10.16	.300/7.62	F		
65039-058LF	12	1.200/30.48	1.100/27.94	F		
65039-059LF	14	1.400/35.56	1.300/33.02	F		
65039-060LF	6	.600/15.24	.500/12.70	A		
65039-061LF	2	.200/5.08	.100/2.54	A		
65039-062LF	2	.200/5.08	.100/2.54	F		
65039-063LF	10	1.000/25.40	.900/22.86	F		
65039-064LF	8	.800/20.32	.700/17.78	G	X	
65039-065LF	13	1.300/33.02	1.200/30.48	A		
65039-066LF	11	1.100/27.94	1.000/25.40	A		
65039-067LF	14	1.400/35.56	1.300/33.02	A		
65039-068LF	21	2.100/53.34	2.000/50.80	A		
65039-069LF	2	.200/5.08	.100/2.54	C		
65039-070LF	8	.800/20.32	.700/17.78	C		
65039-071LF	17	1.700/43.18	1.600/40.64	A		↓
65039-072LF	7	.700/17.78	.600/15.24	STYLE H		1

mat'l. code	SEE NOTE 1	surface	tolerance	projection	product family
ltr	ec'n no	ASME Y14.5 ✓	ASME Y14.5		PV HOUSINGS
BE		tolerances unless otherwise specified		INCH/MM	title
		angles	XXX+01/XX+3	scale 1:1	MINI LATCH HOUSING
		0°±2'	XXX+005/XX+13		SINGLE ROW .100 [2.54] CC
		dr	XXXX+0020/XXX+051		dwg no
		M. CORNMAN	1990-01-31		sheet 7 of 12
		engr	1990-01-31		65039
		H. SUNDY	1990-01-31		A4
		chr	1990-01-31		type
		H. SUNDY	1990-01-31		Product Customer Drawing
sheet index	revision sheet				

form A4mmXLC

1 |

2 |

3 |

4

Copyright FCJ



FCJconnect.com

1 | 2

3 |

4

PRODUCT NO	NO. OF POS.	DIM A MAX	DIM B	SPECIAL MARKINGS	CUSTOMER RESTRICTED	CONFIGURATION
65039-073LF	32	3.200/81.28	3.100/78.74	STYLE A	X	1
65039-074LF	3	.300/7.62	.200/5.08	A		
65039-075LF	16	1.600/40.64	1.500/38.10	E		
65039-076LF	25	2.500/63.50	2.400/60.96	E		
65039-077LF	5	.500/12.70	.400/10.16	J	X	
65039-078LF	24	2.400/60.96	2.300/58.24	A		
65039-079LF	27	2.700/68.58	2.600/66.04	A		
65039-080LF	33	3.300/83.82	3.200/81.28	A		
65039-081LF	29	2.900/73.66	2.800/71.12	A		
65039-082LF	5	.500/12.70	.400/10.16	A		
65039-083LF	7	.700/17.78	.600/15.24	K		
65039-084LF	3	.300/7.62	.200/5.08	E	X	
65039-085LF	9	.900/22.86	.800/20.32	E	X	
65039-086LF	11	1.100/27.94	1.000/25.40	E	X	
65039-087LF	25	2.500/63.50	2.400/60.96	A		
65039-088LF	15	1.500/38.10	1.400/35.56	A		
65039-089LF	4	.400/10.16	.300/7.62	C		
65039-090LF	12	1.200/30.48	1.100/27.94	A		
65039-091LF	4	.400/10.16	.300/7.62	L		
65039-092LF	16	1.600/40.64	1.500/38.10	A		
65039-093LF	18	1.800/45.72	1.700/43.18	A		
65039-094LF	19	1.900/48.26	1.800/45.72	A		
65039-095LF	22	2.200/55.88	2.100/53.34	A		
65039-096LF	23	2.300/58.42	2.200/55.88	A		
65039-097LF	26	2.600/66.04	2.500/63.50	A		
65039-098LF	28	2.800/71.12	2.700/68.58	A		
65039-099LF	30	3.000/76.20	2.900/73.66	A		
65039-100LF	31	3.100/78.74	3.000/76.20	A		
65039-101LF	34	3.400/86.36	3.300/83.82	A		
65039-102LF	35	3.500/88.90	3.400/86.36	A		
65039-103LF	36	3.600/91.44	3.500/88.90	A		
65039-104LF	2	.200/5.08	.100/2.54	E		
65039-105LF	2	.200/5.08	.100/2.54	M		
65039-106LF	3	.300/7.62	.200/5.08	N		
65039-107LF	5	.500/12.70	.400/10.16	N		
65039-108LF	9	.900/22.86	.800/20.32	STYLE F		1

mat'l. code	SEE NOTE 1	surface	tolerance	projection	product family
tr	ec'n no	dr	date	ASME Y14.5 ✓ ASME Y14.5	PV HOUSINGS
BE				tolerances unless otherwise specified	title
				angles	MINI LATCH HOUSING
				finishes	SINGLE ROW .100 [2.54] CC
				0°±2'	INCH/MM
				XXXX+0020/XXX+051	scale 1:1
		dr	M. CORNMAN	1990-01-31	FCJ
		engr	H. SUNDY	1990-01-31	dwg no
		chr	H. SUNDY	1990-01-31	65039
		appd	H. SUNDY	1990-01-31	sheet 8 of 12
sheet index	revision sheet				size A4
					type Product Customer Drawing

form A4mmXLC

1 |

2 |

3 |

4

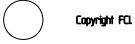

1 | 2

3

4

PRODUCT NO	NO. OF POS.	DIM A MAX	DIM B	SPECIAL MARKINGS	CUSTOMER RESTRICTED	CONFIGURATION
65039-109LF	2	.200/5.08	.100/2.54	STYLE P		1
65039-110LF	5	.500/12.7	.400/10.16	STYLE R		1
65039-111LF	5	.500/12.7	.400/10.16	STYLE S		1

A

A

B

B

mat'l. code	SEE NOTE 1	surface	tolerance	projection	product family
lfr	ecrn no	dr	date	ASME Y14.5	ASME Y14.5
BE					PV HOUSINGS
		angles	tolerances unless otherwise specified	INCH/MM	title
		0°±2'	XXX+01/XX+3	scale 1:1	MINI LATCH HOUSING
			XXX+005/XX+13		SINGLE ROW .100 [2.54] CC
		dr	M. CORNMAN	1990-01-31	FCJ
		engr	H. SUNDY	1990-01-31	dwg no
		chr	H. SUNDY	1990-01-31	65039
		appd	H. SUNDY	1990-01-31	sheet 9 of 12
sheet index	revision sheet				size A4
					type Product Customer Drawing

form: A4mmXLC

1

2

3

4

Copyright FCJ



FCJconnect.com

PRODUCT NO	NO. OF POS.	DIM A MAX	DIM B	SPECIAL MARKINGS	CUSTOMER RESTRICTED	CONFIGURATION
65039-201LF	36	3.600/91.44	3.500/88.90	NOTE 9	NOTE 9	2
65039-202LF	35	3.500/88.90	3.400/86.36			
65039-203LF	34	3.400/86.36	3.300/83.82			
65039-204LF	33	3.300/83.82	3.200/81.28			
65039-205LF	32	3.200/81.28	3.100/78.74			
65039-206LF	31	3.100/78.74	3.000/76.20			
65039-207LF	30	3.000/76.20	2.900/73.66			
65039-208LF	29	2.900/73.66	2.800/71.12			
65039-209LF	28	2.800/71.12	2.700/68.58			
65039-210LF	27	2.700/68.58	2.600/66.04			
65039-211LF	26	2.600/66.04	2.500/63.50			
65039-212LF	25	2.500/63.50	2.400/60.96			
65039-213LF	24	2.400/60.96	2.300/58.24			
65039-214LF	23	2.300/58.24	2.200/55.88			
65039-215LF	22	2.200/55.88	2.100/53.34			
65039-216LF	21	2.100/53.34	2.000/50.80			
65039-217LF	20	2.000/50.80	1.900/48.26			
65039-218LF	19	1.900/48.26	1.800/45.72			
65039-219LF	18	1.800/45.72	1.700/43.18			
65039-220LF	17	1.700/43.18	1.600/40.64			
65039-221LF	16	1.600/40.64	1.500/38.10			
65039-222LF	15	1.500/38.10	1.400/35.56			
65039-223LF	14	1.400/35.56	1.300/33.02			
65039-224LF	13	1.300/33.02	1.200/30.48			
65039-225LF	12	1.200/30.48	1.100/27.94			
65039-226LF	11	1.100/27.94	1.000/25.40			
65039-227LF	10	1.000/25.40	.900/22.86			
65039-228LF	9	.900/22.86	.800/20.32			
65039-229LF	8	.800/20.32	.700/17.78			
65039-230LF	7	.700/17.78	.600/15.24			
65039-231LF	6	.600/15.24	.500/12.70			
65039-232LF	5	.500/12.70	.400/10.16			
65039-233LF	4	.400/10.16	.300/7.62			
65039-234LF	3	.300/7.62	.200/5.08			
65039-235LF	2	.200/5.08	.100/2.54			
65039-236LF	1	.100/2.54		NOTE 9	NOTE 9	2

mat'l code	SEE NOTE 1	surface	tolerance	projection	product family
BE	ecm no	ASME Y14.5 ✓	ASME Y14.5		PV HOUSINGS
	dr	tolerances unless otherwise specified			title
	date	angles	XXX+01/XX+3	INCH/MM	MINI LATCH HOUSING
		0°±2'	XXX+005/XXX+13	scale 1:1	SINGLE ROW .100 [2.54] CC
		dr	XXXX+0020/XXX+051		dwg no
		engr			sheet 10 of 12 size
		chr			65039 A4
		appd			type
sheet index	revision sheet				Product Customer Drawing

form A4mmXLC

Copyright FCJ



FCJconnect.com

1 | 2

3 |

4

PRODUCT NO	NO. OF POS.	DIM A MAX	DIM B	SPECIAL MARKINGS	CUSTOMER RESTRICTED	CONFIGURATION
65039-237LF	8	.800/20.32	.700/17.78	A		2
65039-238LF	8	.800/20.32	.700/17.78	B		
65039-239LF	10	1.000/25.40	.900/22.86	C		
65039-240LF	5	.500/12.70	.400/10.16	C		
65039-241LF	8	.800/20.32	.700/17.78	D		
65039-242LF	8	.800/20.32	.700/17.78	E		
65039-243LF	6	.600/15.24	.500/12.70	E		
65039-244LF	10	1.000/25.40	.900/22.86	A		
65039-245LF	4	.400/10.16	.300/7.62	A		
65039-246LF	9	.900/22.86	.800/20.32	A		
65039-247LF	7	.700/17.78	.600/15.24	A		
65039-248LF	20	2.000/50.80	1.900/48.26	A		
65039-249LF	3	.300/7.62	.200/5.08	C		
65039-250LF	8	.800/20.32	.700/17.78	F		
65039-251LF	16	1.600/40.64	1.500/38.10	F		
65039-252LF	20	2.000/50.80	1.900/48.26	F		
65039-253LF	24	2.400/60.96	2.300/58.24	F		
65039-254LF	19	1.900/48.26	1.800/45.72	E		
65039-255LF	33	3.300/83.82	3.200/81.28	E		
65039-256LF	7	.700/17.78	.600/15.24	E		
65039-257LF	4	.400/10.16	.300/7.62	F		
65039-258LF	12	1.200/30.48	1.100/27.94	F		
65039-259LF	14	1.400/35.56	1.300/33.02	F		
65039-260LF	6	.600/15.24	.500/12.70	A		
65039-261LF	2	.200/5.08	.100/2.54	A		
65039-262LF	2	.200/5.08	.100/2.54	F		
65039-263LF	10	1.000/25.40	.900/22.86	F		
65039-264LF	8	.800/20.32	.700/17.78	G		
65039-265LF	13	1.300/33.02	1.200/30.48	A		
65039-266LF	11	1.100/27.94	1.000/25.40	A		
65039-267LF	14	1.400/35.56	1.300/33.02	A		
65039-268LF	21	2.100/53.34	2.000/50.80	A		
65039-269LF	2	.200/5.08	.100/2.54	C		
65039-270LF	8	.800/20.32	.700/17.78	C		
65039-271LF	17	1.700/43.18	1.600/40.64	A		
65039-272LF	7	.700/17.78	.600/15.24	H		
65039-273LF	32	3.200/81.28	3.100/78.74	A		
65039-274LF	3	.300/7.62	.200/5.08	A		
65039-275LF	16	1.600/40.64	1.500/38.10	E		
65039-276LF	25	2.500/63.50	2.400/60.96	E		
65039-277LF	5	.500/12.70	.400/10.16	J		2

mat'l. code	SEE NOTE 1	surface	tolerance	projection	product family
lfr	ecrn no	ASME Y14.5 ✓	ASME Y14.5		PV HOUSINGS
BE	dr	tolerances unless otherwise specified	angles	INCH/MM	title
			0°±2'	scale 1:1	MINI LATCH HOUSING
					SINGLE ROW .100 [2.54] CC
		dr	M. CORNMAN	1990-01-31	dwg no
		engr	H. SUNDY	1990-01-31	sheet 11 of 12
		chr	H. SUNDY	1990-01-31	size
		appd	H. SUNDY	1990-01-31	65039
sheet index	revision sheet				type Product Customer Drawing

form A4mmXLC

1 |

2 |

3 |

4

Copyright FCJ



FCJconnect.com

1 | 2

3 |

4

PRODUCT NO	NO. OF POS.	DIM A MAX	DIM B	SPECIAL MARKINGS	CUSTOMER RESTRICTED	CONFIGURATION
65039-278LF	24	2.400/60.96	2.300/58.24	A		2
65039-279LF	27	2.700/68.58	2.600/66.04	A		
65039-280LF	33	3.300/83.82	3.200/81.28	A		
65039-281LF	29	2.900/73.66	2.800/71.12	A		
65039-282LF	5	.500/12.70	.400/10.16	A		
65039-283LF	7	.700/17.78	.600/15.24	K		
65039-284LF	3	.300/7.62	.200/5.08	E		
65039-285LF	9	.900/22.86	.800/20.32	E		
65039-286LF	11	1.100/27.94	1.000/25.40	E		
65039-287LF	25	2.500/63.50	2.400/60.96	A		
65039-288LF	15	1.500/38.10	1.400/35.56	A		
65039-289LF	4	.400/10.16	.300/7.62	C		
65039-290LF	12	1.200/30.48	1.100/27.94	A		
65039-291LF	4	.400/10.16	.300/7.62	L		
65039-292LF	16	1.600/40.64	1.500/38.10	A		
65039-293LF	18	1.800/45.72	1.700/43.18	A		
65039-294LF	19	1.900/48.26	1.800/45.72	A		
65039-295LF	22	2.200/55.88	2.100/53.34	A		
65039-296LF	23	2.300/58.24	2.200/55.88	A		
65039-297LF	26	2.600/66.04	2.500/63.50	A		
65039-298LF	28	2.800/71.12	2.700/68.58	A		
65039-299LF	30	3.000/76.20	2.900/73.66	A		
65039-300LF	31	3.100/78.74	3.000/76.20	A		
65039-301LF	34	3.400/86.36	3.300/83.82	A		
65039-302LF	35	3.500/88.90	3.400/86.36	A		
65039-303LF	36	3.600/91.44	3.500/88.90	A		
65039-304LF	2	.200/5.08	.100/2.54	E		
65039-305LF	2	.200/5.08	.100/2.54	M		
65039-306LF	3	.300/7.62	.200/5.08	N		
65039-307LF	5	.500/12.70	.400/10.16	N		
65039-308LF	9	.900/22.86	.800/20.32	F		2

mat'l. code	SEE NOTE 1	surface	tolerance	projection	product family
lfr	ecrn no	dr	date	ASME Y14.5 ✓ ASME Y14.5	PV HOUSINGS
BE				tolerances unless otherwise specified	title
				angles	MINI LATCH HOUSING
				0°±2'	SINGLE ROW .100 [2.54] CC
				dr M. CORNMAN 1990-01-31	dwg no 65039
				engr H. SUNDY 1990-01-31	sheet 12 of 12
				chr H. SUNDY 1990-01-31	size A4
				appd H. SUNDY 1990-01-31	type Product Customer Drawing
sheet index	revision sheet				

form A4mmXc

1 |

2 |

3 |

4

PDM: Rev:BE STATUS: Released Printed: May 01, 2009