

10 9 8 7 6 5 4 3 2 1

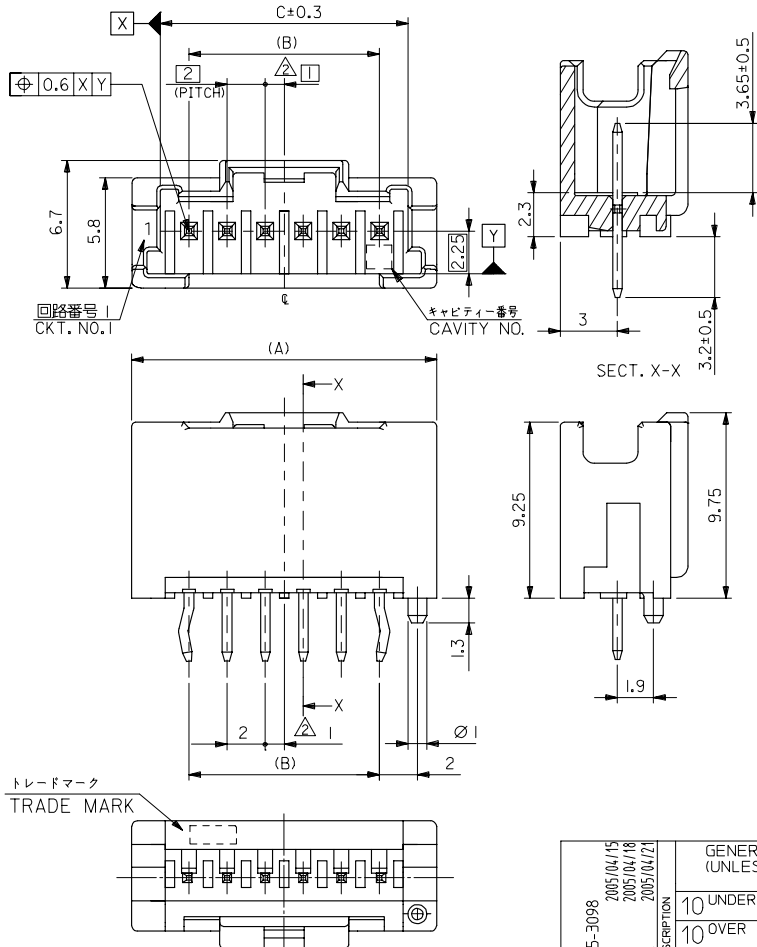

NOTE
 1. 嵌合相手：51382シリーズ
 2. 偶数極（列）に適用。
 3. キングは両外側の位置に付加。
 4. 製品番号 MATERIAL NO.

55932-****
 極数 CIRCUIT SIZE

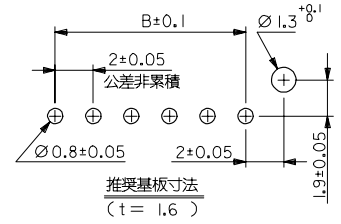

色 COLOR	色 COLOR
10 自然色 (白) NATURAL (WHITE)	10 自然色 (白) NATURAL (WHITE)
11 黒 BLACK	11 黒 BLACK
12 赤 RED	12 赤 RED
13 黄 YELLOW	13 黄 YELLOW
14 青 BLUE	14 青 BLUE
15 桃 PINK	15 桃 PINK
16 緑 GREEN	16 緑 GREEN
17 茶 BROWN	17 茶 BROWN
18 橙 ORANGE	18 橙 ORANGE
19 紫 VIOLET	19 紫 VIOLET
41 灰 GRAY	41 灰 GRAY
43 螢光黄 FLUORESCENCE YELLOW	43 螢光黄 FLUORESCENCE YELLOW
44 水 PALE BLUE	44 水 PALE BLUE
46 黄緑 YELLOWISH GREEN	46 黄緑 YELLOWISH GREEN

31	28	34	55932-15**	15
29	26	32	55932-14**	14
27	24	30	55932-13**	13
25	22	28	55932-12**	12
23	20	26	55932-11**	11
21	18	24	55932-10**	10
19	16	22	55932-09**	9
17	14	20	55932-08**	8
15	12	18	55932-07**	7
13	10	16	55932-06**	6
11	8	14	55932-05**	5
9	6	12	55932-04**	4
7	4	10	55932-03**	3
5	2	8	55932-02**	2
C	B	A	MATERIAL NO. CKT.	

MATERIAL
 ピン : 黄銅、錫メッキ
 ハウジング : PBT

REVISED IEC NO. J2005-3098 2005/04/15 DRAWN BY T.NIITSU 2005/02/08 2005/04/18 CHKD BY K.ASAKAWA 2005/06/12 2005/04/21 APPR. BY T.YAMAGUCHI 2005/06/12	GENERAL TOLERANCES (UNLESS SPECIFIED)		DIMENSION STYLE MM ONLY		SCALE ---	DESIGN UNITS METRIC	THIRD ANGLE PROJECTION
	10 UNDER	±0.2	DRAWN BY T.NIITSU	DATE '02/02/08	TITLE 2.0 W/B SINGLE CONN. PLUG HOUSING ASS'Y ST -LEAD FREE-		
	10 OVER 30 UNDER	±0.25	CHECKED BY K.ASAKAWA	DATE '03/06/12	MOLEX INCORPORATED		
	30 OVER	±0.3	APPROVED BY T.YAMAGUCHI	DATE '03/06/12	DOCUMENT NO. SD-55932-002		
ANGULAR ±3°		DRAFT WHERE APPLICABLE MUST REMAIN WITHIN DIMENSIONS		MATERIAL NO. SEE CHART		SHEET NO. 1 OF 2	
THIS DRAWING CONTAINS INFORMATION THAT IS PROPRIETARY TO MOLEX INCORPORATED AND SHOULD NOT BE USED WITHOUT WRITTEN PERMISSION							

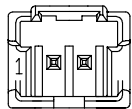
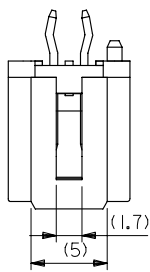

2 CIRCUIT

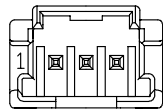
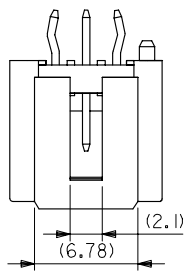

3 CIRCUIT

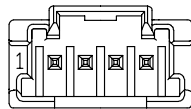
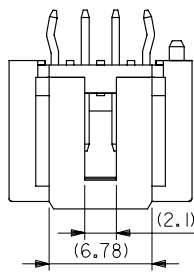

4 CIRCUIT 以上

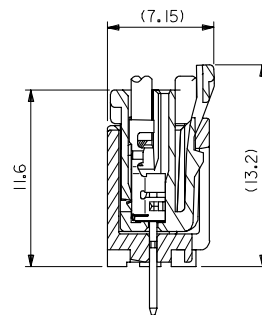

嵌合断面図

MODEL NO. : 55932-*****

REVISED EC. NO. J2005-3098 DRAWN BY T.N.IITSU 2005/04/15 CHKD BY K.ASAKAWA 2005/04/18 APPR. BY T.YAMAGUCHI 2005/04/21	GENERAL TOLERANCES (UNLESS SPECIFIED)		DIMENSION STYLE MM ONLY		SCALE ---	DESIGN UNITS METRIC	THIRD ANGLE PROJECTION
	10 UNDER	±0.2	DRAWN BY	DATE	TITLE		
	10 OVER 30 UNDER	±0.25	CHECKED BY	DATE	2.0 W/B SINGLE CONN. PLUG HOUSING ASS'Y ST -LEAD FREE-		
	30 OVER	±0.3	APPROVED BY	DATE	MOLEX INCORPORATED		
	ANGULAR	±3 °	MATERIAL NO.	DOCUMENT NO.	SHEET NO.		
DRAFT WHERE APPLICABLE MUST REMAIN WITHIN DIMENSIONS		SEE CHART		SD-55932-002		2 OF 2	
THIS DRAWING CONTAINS INFORMATION THAT IS PROPRIETARY TO MOLEX INCORPORATED AND SHOULD NOT BE USED WITHOUT WRITTEN PERMISSION				EN-02JA1021			