

HF **RoHS** **30KPA Series**

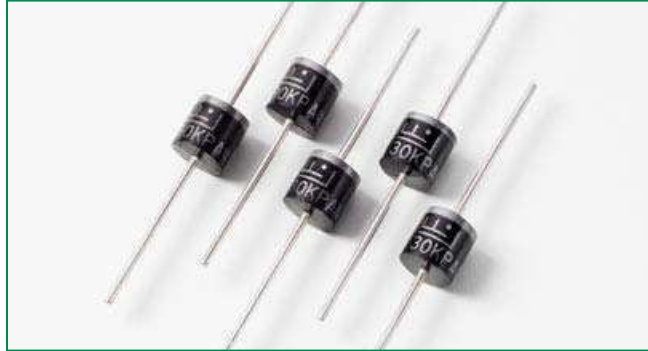

**Agency Approvals**

AGENCY	AGENCY FILE NUMBER
	E230531

**Maximum Ratings and Thermal Characteristics**  
(T<sub>A</sub>=25°C unless otherwise noted)

Parameter	Symbol	Value	Unit
Peak Pulse Power Dissipation by 10x1000µs test waveform (Fig.1) (Note 1)	P <sub>PPM</sub>	30000	W
Steady State Power Dissipation on infinite heat sink at T <sub>L</sub> =75°C (Fig. 5)	P <sub>D</sub>	8.0	W
Peak Forward Surge Current, 8.3ms Single Half Sine Wave Unidirectional only (Note 2)	I <sub>FSM</sub>	400	A
Operating Junction and Storage Temperature Range	T <sub>J</sub> , T <sub>STG</sub>	-55 to 175	°C
Typical Thermal Resistance Junction to Lead	R <sub>θJL</sub>	8.0	°C/W
Typical Thermal Resistance Junction to Ambient	R <sub>θJA</sub>	40	°C/W

- Notes:**
1. Non-repetitive current pulse, per Fig. 3 and derated above T<sub>A</sub> = 25°C per Fig. 2.
  2. Measured on 8.3ms single half sine wave or equivalent square wave, duty cycle=4 per minute maximum.

**Description**

The 30KPA Series is designed specifically to protect sensitive electronic equipment from voltage transients induced by lightning and other transient voltage events.

**Features**

- Halogen-Free
- RoHS compliant
- Typical maximum temperature coefficient  
 $\Delta V_{BR} = 0.1\% \times V_{BR} @ 25^\circ\text{C} \times \Delta T$
- Glass passivated chip junction in P600 package
- 30000W peak pulse capability at 10x1000µs waveform, repetition rate (duty cycles):0.01%
- Fast response time: typically less than 1.0ps from 0 Volts to BV min
- Excellent clamping capability
- Low incremental surge resistance
- Typical I<sub>R</sub> less than 2µA above 73V
- High temperature soldering guaranteed: 260°C/40 seconds / 0.375"(9.5mm) lead length, 5 lbs., (2.3kg) tension
- Plastic package has Underwriters Laboratory Flammability classification 94V-0
- Matte Tin Lead-free plated

**Applications**

TVS devices are ideal for the protection of I/O interfaces, V<sub>CC</sub> bus and other vulnerable circuits used in telecom, computer, industrial and consumer electronic applications.

**30KPA Series**

# Transient Voltage Suppression Diodes

## Axial Leaded – 30000W > 30KPA series

### Electrical Characteristics

Part Number (Uni)	Part Number (Bi)	Reverse Stand off Voltage $V_R$ (Volts)	Breakdown Voltage $V_{BR}$ (Volts) @ $I_T$	Test Current $I_T$ (mA)	Maximum Peak Pulse Current $I_{PP}$ (A)	Maximum Reverse Leakage $I_R$ @ $V_R$ ( $\mu$ A)	Maximum Clamping Voltage $V_C$ @ $I_{PP}$ (V)	Agency Approval 
			MIN					
30KPA28A	30KPA28CA	28	31.28	50	606.0	5000	50.0	X
30KPA30A	30KPA30CA	30	33.51	50	548.9	5000	55.2	X
30KPA33A	30KPA33CA	33	36.90	50	517.9	5000	58.5	X
30KPA36A	30KPA36CA	36	40.20	50	490.3	5000	61.8	X
30KPA39A	30KPA39CA	39	43.60	20	450.9	2000	67.2	X
30KPA42A	30KPA42CA	42	46.90	10	420.8	1000	72.0	X
30KPA43A	30KPA43CA	43	48.00	10	415.1	1000	73.0	X
30KPA45A	30KPA45CA	45	50.30	5	391.5	250	77.4	X
30KPA48A	30KPA48CA	48	53.60	5	371.3	150	81.6	X
30KPA51A	30KPA51CA	51	57.00	5	350.7	50	86.4	X
30KPA54A	30KPA54CA	54	60.30	5	331.5	20	91.4	X
30KPA58A	30KPA58CA	58	64.80	5	327.9	20	92.4	X
30KPA60A	30KPA60CA	60	67.00	5	297.1	15	102.0	X
30KPA64A	30KPA64CA	64	71.50	5	291.3	10	104.0	X
30KPA66A	30KPA66CA	66	73.70	5	283.2	2	107.0	X
30KPA70A	30KPA70CA	70	78.20	5	278.0	2	109.0	X
30KPA71A	30KPA71CA	71	79.30	5	271.7	2	111.5	X
30KPA72A	30KPA72CA	72	80.40	5	265.8	2	114.0	X
30KPA75A	30KPA75CA	75	83.80	5	253.8	2	119.4	X
30KPA78A	30KPA78CA	78	87.10	5	234.9	2	129.0	X
30KPA84A	30KPA84CA	84	93.80	5	217.7	2	139.2	X
30KPA90A	30KPA90CA	90	100.50	5	207.0	2	146.4	X
30KPA96A	30KPA96CA	96	107.20	5	194.2	2	156.0	X
30KPA102A	30KPA102CA	102	113.90	5	183.0	2	165.6	X
30KPA108A	30KPA108CA	108	120.60	5	172.9	2	175.2	X
30KPA120A	30KPA120CA	120	134.00	5	155.9	2	194.4	X
30KPA132A	30KPA132CA	132	147.40	5	142.3	2	213.0	X
30KPA144A	30KPA144CA	144	160.80	5	135.8	2	223.2	X
30KPA150A	30KPA150CA	150	167.60	5	129.8	2	233.4	X
30KPA156A	30KPA156CA	156	174.30	5	123.7	2	245.0	X
30KPA160A	30KPA160CA	160	178.70	5	120.0	2	252.6	X
30KPA168A	30KPA168CA	168	187.70	5	111.2	2	272.4	X
30KPA170A	30KPA170CA	170	189.90	5	110.2	2	275.0	X
30KPA180A	30KPA180CA	180	201.10	5	104.3	2	290.4	X
30KPA198A	30KPA198CA	198	221.20	5	94.7	2	319.8	X
30KPA216A	30KPA216CA	216	241.30	5	86.9	2	348.6	X
30KPA240A	30KPA240CA	240	268.10	5	78.3	2	387.0	X
30KPA258A	30KPA258CA	258	288.20	5	72.8	2	416.4	X
30KPA260A	30KPA260CA	260	290.40	5	72.8	2	416.0	X
30KPA270A	30KPA270CA	270	301.60	5	69.5	2	436.2	X
30KPA280A	30KPA280CA	280	312.80	5	65.3	2	464.0	X
30KPA288A	30KPA288CA	288	321.70	5	64.5	2	469.9	X

For bidirectional type having  $V_{RWM}$  of 60 volts and less, the  $I_T$  limit is double.

For parts without A, the  $V_{BR}$  is  $\pm 10\%$ .

**Ratings and Characteristic Curves** ( $T_A=25^\circ\text{C}$  unless otherwise noted)

**Figure 1 - Peak Pulse Power Rating Curve**

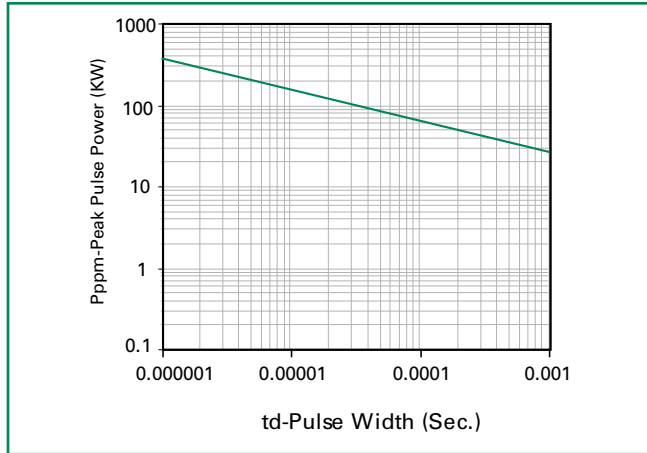

**Figure 2 - Pulse Derating Curve**

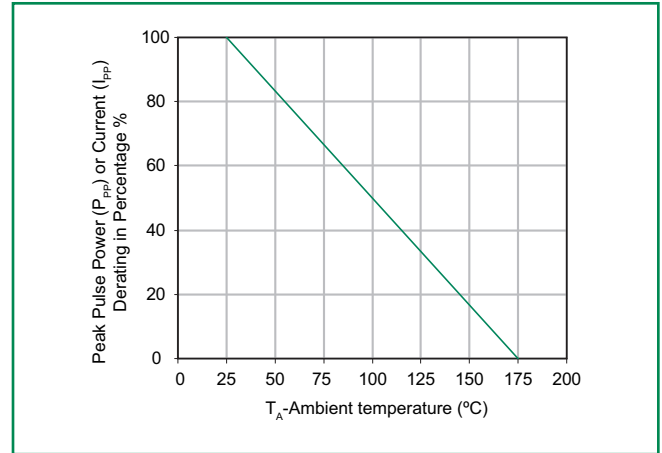

**Figure 3 - Pulse Waveform**

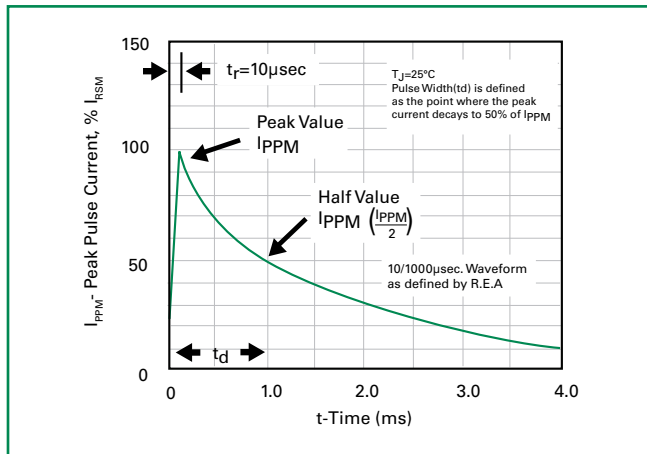

**Figure 4 - Typical Junction Capacitance**

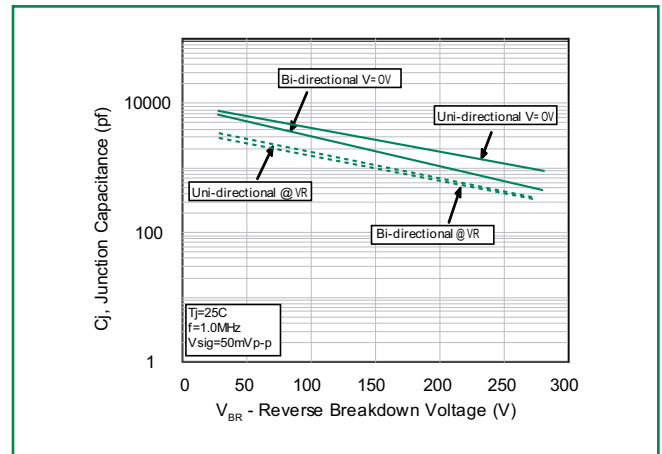

**Figure 5 - Steady State Power Derating Curve**

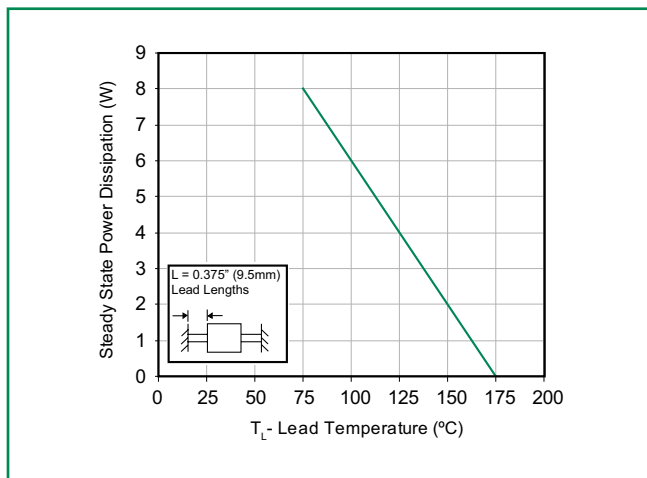

**Figure 6 - Maximum Non-Repetitive Peak Forward Surge Current**

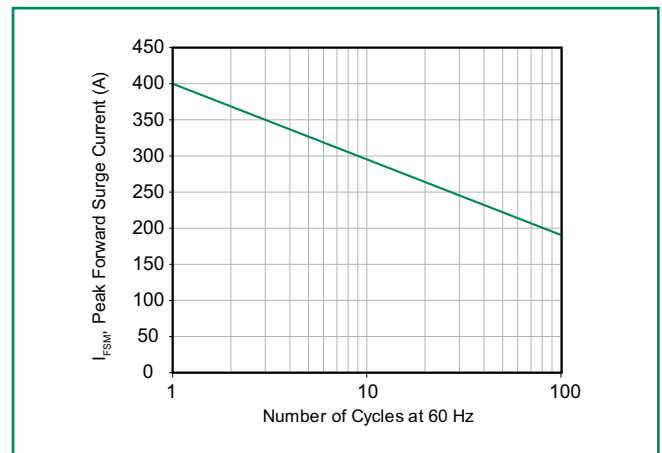

**30KPA Series**

## Soldering Parameters

Reflow Condition		Lead-free assembly
Pre Heat	- Temperature Min ( $T_{s(min)}$ )	150°C
	- Temperature Max ( $T_{s(max)}$ )	200°C
	- Time (min to max) ( $t_s$ )	60 – 180 secs
Average ramp up rate (Liquidus Temp ( $T_L$ ) to peak)		3°C/second max
$T_{s(max)}$ to $T_L$ - Ramp-up Rate		3°C/second max
Reflow	- Temperature ( $T_L$ ) (Liquidus)	217°C
	- Time (min to max) ( $t_s$ )	60 – 150 seconds
Peak Temperature ( $T_p$ )		260 <sup>+0/-5</sup> °C
Time within 5°C of actual peak Temperature ( $t_p$ )		20 – 40 seconds
Ramp-down Rate		6°C/second max
Time 25°C to peak Temperature ( $T_p$ )		8 minutes Max.
Do not exceed		280°C

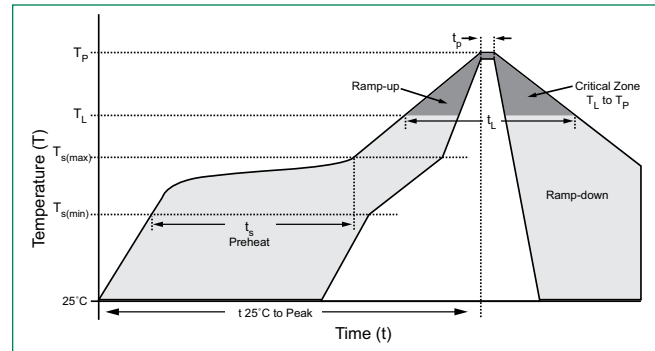

## Flow/Wave Soldering (Solder Dipping)

<b>Peak Temperature :</b>	265°C
<b>Dipping Time :</b>	10 seconds
<b>Soldering :</b>	1 time

## Physical Specifications

<b>Weight</b>	0.07oz., 2.5g
<b>Case</b>	P600 molded plastic body over passivated junction.
<b>Polarity</b>	Color band denotes the cathode except Bipolar.
<b>Terminal</b>	Matte Tin axial leads, solderable per JESD22-B102D.

## Environmental Specifications

<b>Temperature Cycle</b>	JESD22-A104
<b>Pressure Cooker</b>	JESD 22-A102
<b>High Temp. Storage</b>	JESD22-A103
<b>HTRB</b>	JESD22-A108
<b>Thermal Shock</b>	JESD22-A106

## Dimensions

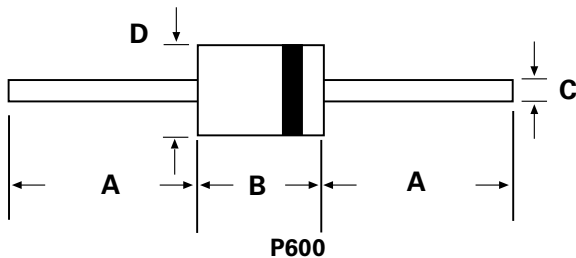

Dimensions	Inches		Millimeters	
	Min	Max	Min	Max
A	1.000	-	25.40	-
B	0.340	0.360	8.60	9.10
C	0.048	0.052	1.22	1.32
D	0.340	0.360	8.60	9.10

## Part Numbering System

**30KPA xxx XX X**

**OPTION CODE:**

- BLANK** Reel Tape
- B** Bulk Packaging

**TYPE CODE:**

- A** Uni-Directional (5% Voltage Tolerance)
- CA** Bi-Directional

**VOLTAGE CODE**

(Refer to the Electrical Characteristics table)

**SERIES CODE**

## Part Marking System

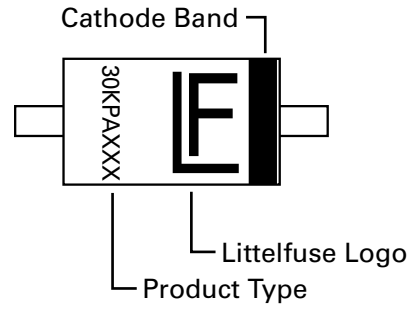

## Packaging

Part Number	Component Package	Quantity	Packaging Option	Packaging Specification
30KPAxxxXX	P600	800	Tape & Reel	EIA STD RS-296E
30KPAxxxXX-B	P600	500	BULK	Littelfuse Concord Packing Spec. DM-0016