

LOC	DIST	REVISIONS				
P	LTR	DESCRIPTION	DATE	DWN	APVD	
E	B	BA	NEW RELEASE	05MAY2010	PT	St.P

FOR FURTHER INFORMATION SEE DATA SHEET FOR
 RP73 SERIES-SMD HIGH POWER PRECISION RESISTORS

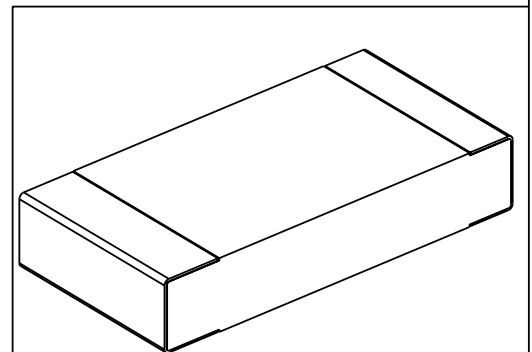
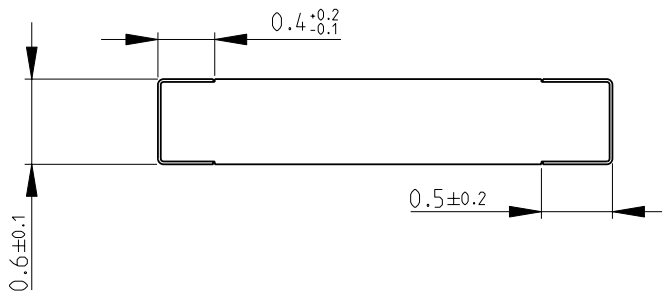
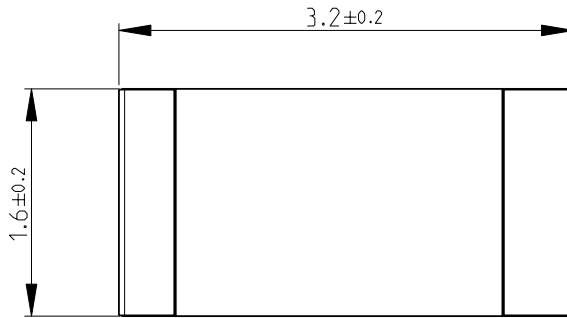

RoHS Compliant

2008

RELEASED FOR PUBLICATION

BY TYCO ELECTRONICS CORPORATION. ALL RIGHTS RESERVED.

© COPYRIGHT 2008

THIS DRAWING IS UNPUBLISHED.

DIMENSIONS: mm	DWN	PARUSURAM.T	05MAY2010	MATERIAL	-	FINISH	-
	CHK	SUBHASH.M	05MAY2010	Tyco Electronics Corporation Dorcan, Swindon, SN3 5HH			
TOLERANCES UNLESS OTHERWISE SPECIFIED:	APVD	STEPHEN.P	05MAY2010				
0 PLC ±0.2	PRODUCT SPEC	-	NAME	SMD HIGH POWER PRECISION RESISTORS SERIES RP73 - 2B			
1 PLC ±0.1	APPLICATION SPEC	-	SIZE	CAGE CODE	DRAWING NO	RESTRICTED TO	
2 PLC ±-	WEIGHT	-	A 4	00779	©= 1879261	-	
3 PLC ±-	CUSTOMER DRAWING			SCALE	20:1	SHEET	1 OF 1
4 PLC ±-						REV	BA
ANGLES ±5°							

