

LOC	DIST	REVISIONS				
P	LTR	DESCRIPTION	DATE	DWN	APVD	
E	B	BA	NEW RELEASE	04MAY2010	PT	St.P

FOR FURTHER INFORMATION SEE DATA SHEET FOR  
RP73 SERIES-SMD HIGH POWER PRECISION RESISTORS

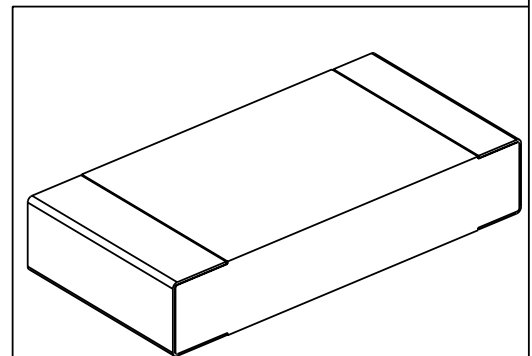
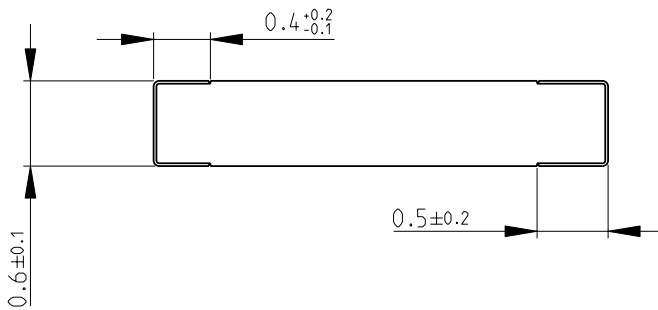
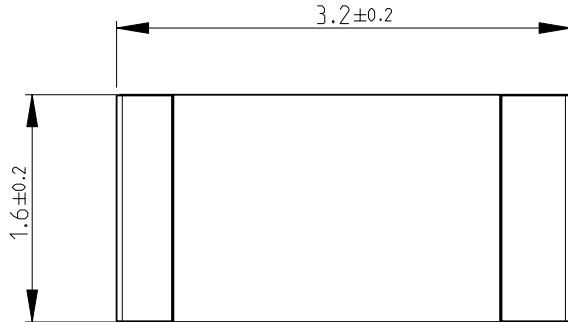

RoHS Compliant

2008

RELEASED FOR PUBLICATION

THIS DRAWING IS UNPUBLISHED.

© COPYRIGHT 2008 BY TYCO ELECTRONICS CORPORATION. ALL RIGHTS RESERVED.

DIMENSIONS: mm	DWN	PARUSURAM.T	04MAY2010	MATERIAL	-	FINISH	-
	CHK	SUBHASH.M	04MAY2010	Tyco Electronics Corporation Dorcan, Swindon, SN3 5HH			
TOLERANCES UNLESS OTHERWISE SPECIFIED:  0 PLC ±0.2 1 PLC ±0.1 2 PLC ±- 3 PLC ±- 4 PLC ±- ANGLES ±5°	APVD	STEPHEN.P	04MAY2010				
	PRODUCT SPEC	-		NAME			
	APPLICATION SPEC	-		SMD HIGH POWER PRECISION RESISTORS SERIES RP73 - 2B			
	WEIGHT	-		SIZE	A 4	CAGE CODE	00779
				DRAWING NO	C= 1879255		RESTRICTED TO
							-
CUSTOMER DRAWING				SCALE	20:1	SHEET	1 OF 1
						REV	BA