	TYPE APPLICATION SPECIFICATION	NUMBER GS-20-002	
	TITLE Specification of Requirements for Cable Preparation, Wire Termination and Assembly of Connectors Using 72392-type Contacts	PAGE 1 of 29	REVISION J
AUTHORIZED BY J.R. Volstorf		DATE 25-Apr-06	
STATUS UNRESTRICTED			

TABLE OF CONTENTS

1.0 PURPOSE.....	4
2.0 SCOPE.....	4
3.0 GENERAL.....	4
3.1 Method of Specifying.....	4
3.2 Workmanship.....	4
3.3 Usage.....	4
3.4 Visual.....	4
4.0 PRODUCT DESCRIPTIONS.....	5
4.1 72476 type 4-row Metral™ Unshielded Connector.....	5
4.2 72477 type 4-row Metral™ Unshielded Connector.....	6
4.3 88940 type 4-row Metral™ Unshielded Connector.....	6
5.0 CABLE PREPARATION.....	7
5.1 72476, 72477 and 88940 type 4-row Metral™ Unshielded Connectors.....	7
6.0 DESIGNING WIRING DIAGRAMS.....	7
7.0 RECOMMENDED WIRE SIZES AND INSULATIONS.....	8
7.1 Wire Insulation Materials.....	8
7.2 Maximum Insulation Diameters and Wire Sizes.....	8
7.3 Uninsulated Wires.....	9
7.4 Conductor Materials.....	9
8.0 POSITION OF CONNECTOR SUB-ASSEMBLY TO CABLE.....	9
8.1 72476 and 72477 type 4-row Metral™ Unshielded Connectors.....	9
8.2 88940 - type Metral™ Unshielded Connectors.....	10
9.0 ACCEPTABLE WIRE TERMINATION.....	10
9.1 Termination Requirements, Visual.....	11
9.1.1 Wire Location.....	11
9.1.2 Wire Depth.....	12
9.1.3 Strain Relief.....	13
9.1.4 IDC Terminal Damage.....	13
9.1.5 Wire Damage.....	13
9.2 Tool Setup and Destructive Inspection Techniques.....	13
9.2.1 Wire Removal.....	13
9.2.2 IDC Terminal Damage.....	13
9.2.3 Acceptable Metallic Contact.....	13

	TYPE	NUMBER	
	APPLICATION SPECIFICATION	GS-20-002	
TITLE Specification of Requirements for Cable Preparation, Wire Termination and Assembly of Connectors Using 72392-type Contacts	PAGE	2 of 29	REVISION
	AUTHORIZED BY	J.R. Volstorf	DATE
			25-Apr-06
	STATUS	UNRESTRICTED	

10.0	CONNECTOR SUB-ASSEMBLIES - GENERAL	13
10.1	Contact Retention	13
10.2	Connector Insulator Damage	14
10.2.1	Termination Tool Misalignment	14
10.3	Wire Terminators	14
10.3.1	Automatic Terminators	14
10.3.2	Hand Tools	16
11.0	ASSEMBLY OF COMPONENTS AFTER WIRE INSERTION	17
11.1	72476 and 72477 type Metral™ Unshielded Connectors	17
11.1.1	Assembly of Covers to Connector Sub-Assemblies	17
11.1.2	Assembly of Latch Finger to Covers	19
11.1.3	Assembly of Cable Tie	19
11.1.4	Assembly of Optional Coding Keys to Covers	20
11.2	88940 type Metral™ Unshielded Connectors	20
12.0	REPAIR PROCEDURES	21
12.1	Repair Tooling	21
12.2	Wire Replacement	21
12.3	Damaged Contacts in a Completed Connector	21
12.4	Removing Contacts from the Insulator	21
12.5	Inserting Contacts into the Insulator	21
12.6	Wires Inserted in Wrong Position or Defective Insertion	22
12.6.1	Preferred Method of Repair	22
12.6.2	Alternate Methods of Repair	23
12.6.2.1	Wires Inserted in Wrong Position	23
12.6.2.2	Defective Insertions	23
12.6.2.2.1	Reinsertion of Wire in IDC of Contact	23
12.6.2.2.2	Soldering of Wire in Contact	25
12.7	Replacing Latches	26
12.8	Replacing or Removing Covers	26
13.0	USE OF CONNECTORS WITH MATING PRODUCTS	26
13.1	72476 and 72477 type Metral™ Unshielded Connectors	26
13.2	88940 type Metral™ Unshielded Connectors	26
14.0	NOTES	28
15.0	NOTES	28
16.0	REFERENCE DOCUMENTS	28



	TYPE APPLICATION SPECIFICATION	NUMBER GS-20-002	
	TITLE Specification of Requirements for Cable Preparation, Wire Termination and Assembly of Connectors Using 72392-type Contacts	PAGE 3 of 29	REVISION J
AUTHORIZED BY J.R. Volstorf		DATE 25-Apr-06	
STATUS UNRESTRICTED			

Figure 1	4x6 Unshielded Connector	5
Figure 2	4x12 Unshielded Connector	6
Figure 3	2x10 & 2x6 Unshielded Connector	6
Figure 4	Cable Preparation - Unshielded Connectors	7
Figure 5	Wiring Diagram - 72476 Unshielded Connectors	7
Figure 6	Wiring Diagram - 72477 Unshielded Connectors	8
Figure 7	Dimensions - Single Or Multiple Cables per Unshielded Connector	9
Figure 8	Dimensions - Multiple Unshielded Connectors per Cable	10
Figure 9	Wire Insertion Visual Requirements	11
Figure 10	Wire Depth Gage	12
Figure 11	TL-230 Automatic Terminator	15
Figure 12	BPY6737PC1xx Automatic Terminator	16
Figure 13	Hand Tool Terminator	16
Figure 14	Assembly of Covers - 72476 type Connectors	17
Figure 15	Assembly of Covers - 72477 type Connectors	18
Figure 16	Cover Assembly Fixture	18
Figure 17	Assembly of Latch Finger	19
Figure 18	Assembly of Cable Tie	19
Figure 19	Assembly of Coding Keys	20
Figure 20	Checking for Proper Contact Latching After Insertion	22
Figure 21	Checking for Damaged Terminal After Insertion	22
Figure 22	Preparing Wire for Reinsertion	23
Figure 23	HT-0525 Wire Insertion Repair Tool	24
Figure 24	BPY75D37 Wire Insertion Repair Tool	24
Figure 25	Solder Repair of Defective Insertion	25
Figure 26	Mating Headers & Shrouds	26
Figure 27	Mating Retainers	27

	TYPE	APPLICATION SPECIFICATION		NUMBER	GS-20-002			
	TITLE	Specification of Requirements for Cable Preparation, Wire Termination and Assembly of Connectors Using 72392-type Contacts			PAGE	4 of 29	REVISION	J
				AUTHORIZED BY	J.R. Volstorf		DATE	25-Apr-06
				STATUS	UNRESTRICTED			

1.0 PURPOSE

This specification covers end product and workmanship requirements for cable preparation, wire termination and assembly of the following Metral™ connectors using the 72392 type insulation displacement contacts.

72476-type 4x6 Metral™ unshielded cable connectors

72477-type 4x12 Metral™ unshielded cable connectors

88940-type 2x6 & 2x10 Metral™ unshielded cable connectors

2.0 SCOPE

- Recommended cable preparation
- Recommendations on wire types that may be terminated.
No deviation of wire size, insulation type or insulation thickness from those listed in section **“Recommended Wire Sizes and Insulations”** should be used without approval of the FCI engineering design group responsible for this product. Please refer all question to your local FCI representative.
- Recommended requirements on completed termination
- Recommended repair procedures for wire terminations
- Assembly of components after wire termination

3.0 GENERAL

3.1 Method of Specifying

The cable assembly and detail drawings should reference this specification when applicable. All exceptions to the requirements of this specification should be clearly described in the notes of the cable assembly drawing. We do not recommend any exceptions unless approval is obtained in advance from the FCI engineering design group.

3.2 Workmanship

Workmanship shall be of a level that indicates controlled conditions of manufacture such that subsequent operations, functionality and performance are not degraded.

3.3 Usage

The connectors covered by this instruction are intended for use in a wide variety of environments and are designed to meet the conditions specified in Bellcore GR-1217-CORE and IEC-61076-4-110.

Banned/Restricted Substances

All product where the part number ends in ‘LF’ meet the European Union directives and other country regulations as described in GS-22-008. The part numbers that do not end in ‘LF’ meet all regulations except for Pb in SnPb plating.

Manufacturing Processability

All products covered by this specification will not withstand exposure to convection, infra-red or vapor phase reflow ovens. Do not heat this product above 110°C.

3.4 Visual

Visual examinations shall be performed with a magnification of up to 10x. (8 to 10x recommended)

	TYPE APPLICATION SPECIFICATION	NUMBER GS-20-002	
	TITLE Specification of Requirements for Cable Preparation, Wire Termination and Assembly of Connectors Using 72392-type Contacts	PAGE 5 of 29	REVISION J
	AUTHORIZED BY J.R. Volstorf	DATE 25-Apr-06	
	STATUS UNRESTRICTED		

4.0 Product Descriptions

4.1 **72476 type 4-row Metra™ Unshielded Connector**

This connector is a 4x6 2mm pitch cable connector with IDC type contacts. The connectors are sold in kits with the following variations.

as 72476-wxy1 where

“w” specifies the plating on the separable contact

w = 1 , for 0.8um Gold

w = 2 , for 2.0um Gold

w = 3 , for 1.3um Gold

w = 9 , for 0.8um GXT

“y” specifies the wire gage capacity

y = 1 , for 26-24 gage wire

y = 2 , for 30-28 gage wire

“x” specifies the latch finger type

x = 1 , for cable diameters up to 7.0mm

x = 2 , for cable diameters up to 11.0mm

Figure 1 4x6 Unshielded Connector

Product Number
72476-w1y1

Product Number
72476-w2y1

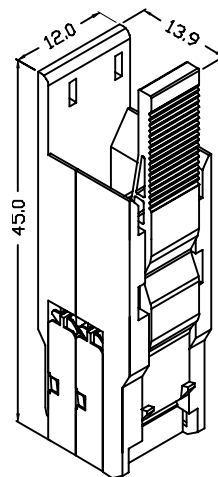

Standard Latch Finger

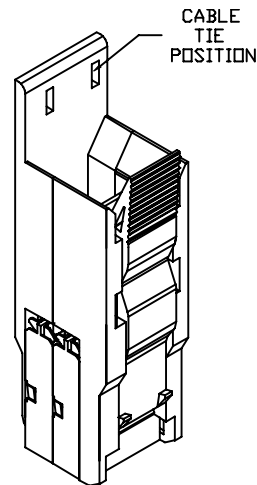

Short Latch Finger

The difference between the standard latch finger (x = 1) and the short latch finger (x = 2) is that the standard latch stands above the cable tie and is easier to access but thus restricts the maximum diameter cable that can be used. In certain cases the use of multiple cables or the stripping of the cable jacket above the cable tie area of the connector will allow the user to overcome some restrictions.

	TYPE APPLICATION SPECIFICATION	NUMBER GS-20-002	
	TITLE Specification of Requirements for Cable Preparation, Wire Termination and Assembly of Connectors Using 72392-type Contacts	PAGE 6 of 29	REVISION J
AUTHORIZED BY J.R. Volstorf		DATE 25-Apr-06	
STATUS UNRESTRICTED			

4.2 72477 type 4-row Metra™ Unshielded Connector

This connector is a 4x12 2mm pitch cable connector with IDC type contacts. The connectors are sold in kits with the same variations as the 72476 types and adapt to slightly larger cables .
as 72477-wxy1 where

- x = 1 , for cable diameters up to 9.5mm
- x = 2 , for cable diameters up to 11.5mm

Figure 2 4x12 Unshielded Connector

Product Number Product Number
72477-w1y1 72477-w2y1

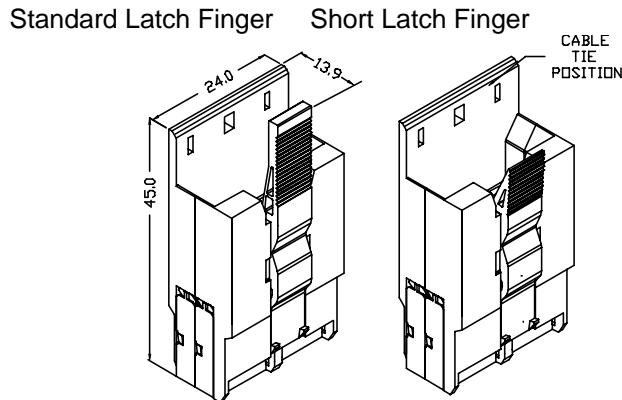



4.3 88940 type 4-row Metra™ Unshielded Connector

These connectors come in 2x10 & 2x6 2mm pitch cable connector with IDC type contacts. Please contact your FCI representative to obtain data on cables that can be used with this connector. The connectors are sold only with 0.8um GXT plating on the separable contacts and for 26 to 24 gage wire sizes.

Figure 3 2x10 & 2x6 Unshielded Connector

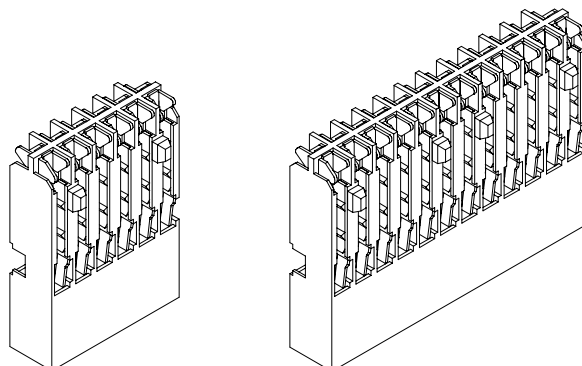
88940-001 88940-002



	TYPE APPLICATION SPECIFICATION	NUMBER GS-20-002	
	TITLE Specification of Requirements for Cable Preparation, Wire Termination and Assembly of Connectors Using 72392-type Contacts	PAGE 7 of 29	REVISION J
	AUTHORIZED BY J.R. Volstorf	DATE 25-Apr-06	
	STATUS UNRESTRICTED		

5.0 Cable Preparation

See "ASSEMBLY OF COMPONENTS AFTER WIRE INSERTION" for restrictions on cable diameters of each connector. See section "APPLICATION TOOLING" for available wire insertion equipment.

5.1 72476, 72477 and 88940 type 4-row Metra™ Unshielded Connectors

The following recommendations are for cable assemblies where one or more cables are being terminated to one connector and the user wished to tie the cable jacket to the connector cover for added strain relief. In the cases where more than one connector is being attached to one cable follow the cable assembly drawing instructions.

Figure 4 Cable Preparation - Unshielded Connectors

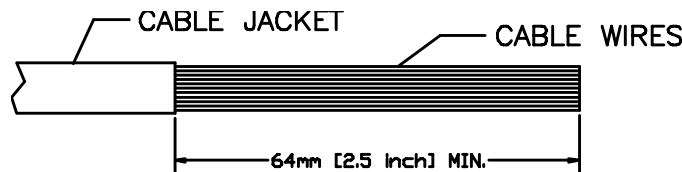

6.0 DESIGNING WIRING DIAGRAMS

The connector sub-assemblies are polarized with respect to the latch side of the connector. On wiring diagrams this polarization feature must be specified so that when the wire insertion operation is performed, the operator can properly orient the parts to the cable. In addition, on connectors using more than one connector sub-assembly, the cable assembly drawing and wiring diagram must specify a scheme to identify which connector sub-assembly will occupy which position in the connector assembly.

Figure 5 Wiring Diagram - 72476 Unshielded Connectors

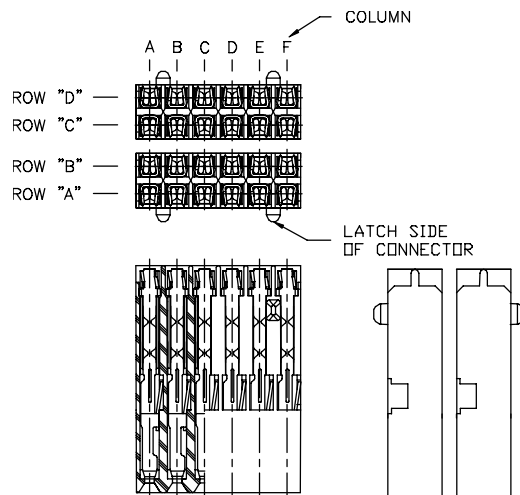

	TYPE APPLICATION SPECIFICATION	NUMBER GS-20-002	
	TITLE Specification of Requirements for Cable Preparation, Wire Termination and Assembly of Connectors Using 72392-type Contacts	PAGE 8 of 29	REVISION J
		AUTHORIZED BY J.R. Volstorf	DATE 25-Apr-06
		STATUS UNRESTRICTED	

Figure 6 Wiring Diagram - 72477 Unshielded Connectors



No standard wiring diagram exists for the 88940 type Connectors

7.0 RECOMMENDED WIRE SIZES AND INSULATIONS

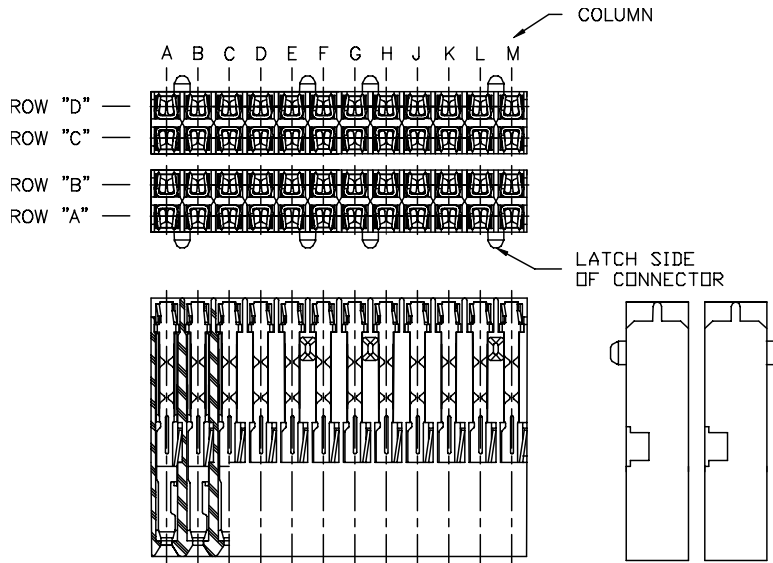
7.1 *Wire Insulation Materials*

Semi-rigid PVC, FEP, DP-3, PVC/PE, PTFE, PE, PP have been used.

7.2 *Maximum Insulation Diameters and Wire Sizes*

Conductor Size	Maximum Insulation Dimensions			
	Insulation Thickness		Insulation Diameter	
	mm	inch	mm	inch
30 gage solid	0.27	0.011	0.80	0.032
.3mm solid	0.28	0.011	0.86	0.034
28 gage solid	0.32	0.013	0.96	0.038
.4mm solid	0.30	0.012	1.00	0.040
26 gage solid	0.30	0.012	1.00	0.040
.5mm solid	0.25	0.010	1.00	0.040
24 gage solid	0.245	0.010	1.00	0.040

Certain stranded wires can be successfully inserted in the contact IDC but must be qualified individually. The specification of the cable using the stranded wire must have the wire insulation type, wire insulation thickness, number of strands, size of strands and twist of strands controlled.

	TYPE APPLICATION SPECIFICATION	NUMBER GS-20-002	
	TITLE Specification of Requirements for Cable Preparation, Wire Termination and Assembly of Connectors Using 72392-type Contacts	PAGE 9 of 29	REVISION J
	AUTHORIZED BY J.R. Volstorf	DATE 25-Apr-06	
	STATUS UNRESTRICTED		

7.3 Uninsulated Wires

Uninsulated wires of sizes 28, 26 & 24 gage plus .5mm and .4mm diameter have been successfully inserted in the contacts.

7.4 Conductor Materials

Bare copper wire
 Sn plated copper wire
 Ag plated copper wire

8.0 POSITION OF CONNECTOR SUB-ASSEMBLY TO CABLE

8.1 72476 and 72477 type 4-row Metral™ Unshielded Connectors

A variety of conditions can exist after wire insertion depending on the cable size and number of cables used. The following shows several cases where single or multiple cables are used per connector. The 10 to 18mm dimension represents the distance range from the 2x5 connector sub-assembly to the cable jacket that allows the cable tie to fasten to the cable jacket. The positioning of the cables in the insertion equipment controls the final position of the end of the cable jacket to the connector sub-assembly.

Figure 7 Dimensions - Single Or Multiple Cables per Unshielded Connector

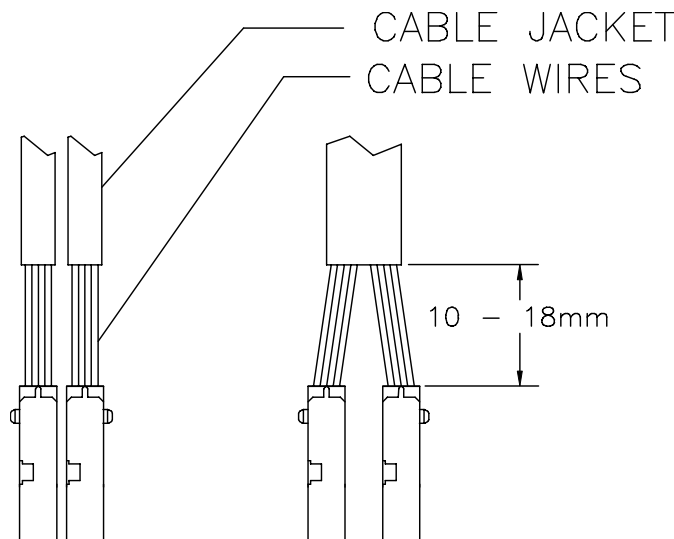

A different condition exists when multiple connectors are assembled to one cable. In this case the cable jacket must be stripped back to the point that the cable ties can only wrap around a bundle of wires. In the case of hard wire insulation this method is acceptable but in the case of soft insulation a small piece of heat shrink tubing may be needed in the area of the cable tie to group the wires and prevent the cable tie from penetrating the wire insulation. However, each of the contacts has its own wire strain relief and in most applications the cable strain relief is not needed. The cable assembly designer may have to specify that the heat shrink tube be slid on each bundle of wires before wire insertion depending on size and shrink rate of the tubing selected.

	TYPE APPLICATION SPECIFICATION	NUMBER GS-20-002	
	TITLE Specification of Requirements for Cable Preparation, Wire Termination and Assembly of Connectors Using 72392-type Contacts	PAGE 10 of 29	REVISION J
AUTHORIZED BY J.R. Volstorf		DATE 25-Apr-06	
STATUS UNRESTRICTED			

Figure 8 Dimensions - Multiple Unshielded Connectors per Cable



8.2 88940 - type Metra™ Unshielded Connectors

These connectors have only a wire strain relief on each contact and do not have a cable jacket strain relief option. Therefore there is no requirement on the position of the cable jacket to the connector. Multiple connectors may be attached to the same cable.

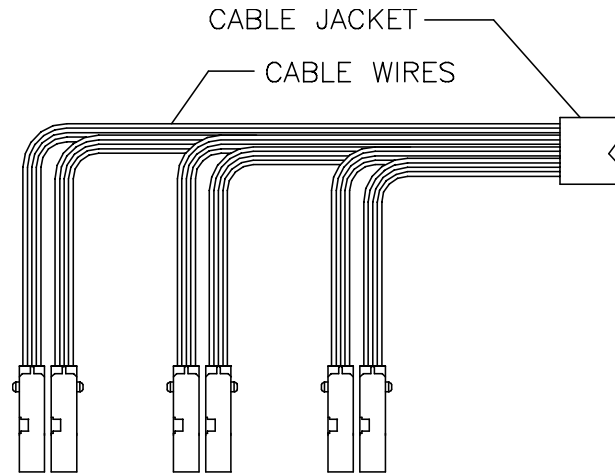
9.0 ACCEPTABLE WIRE TERMINATION

Caution: The wire strain relief of each contact must be closed by the wire insertion punch even if no wire is inserted into the contact! If the strain reliefs are not closed, a short can occur between contacts on both shielded and unshielded connectors or between the contact and metal shields on shielded connectors.

The automatic wire terminators will set all the unused contacts unless the machine cycle is interrupted. When using hand tools, the operator must index the connector sub-assembly to all unused positions and activate the hand tool.

	TYPE APPLICATION SPECIFICATION	NUMBER GS-20-002		
	TITLE Specification of Requirements for Cable Preparation, Wire Termination and Assembly of Connectors Using 72392-type Contacts	PAGE 11 of 29	REVISION J	
		AUTHORIZED BY J.R. Volstorf	DATE 25-Apr-06	
		STATUS UNRESTRICTED		

9.1 Termination Requirements, Visual

Requirements for an acceptable termination are shown in Figure 19 as well as non-destructive visual inspection methods to insure satisfactory terminations without removing wires.

9.1.1 Wire Location

The copper conductor shall extend at least .75mm beyond the IDC dimples. This requirement shall be considered met if the wire insulation extends at least 1.00mmj beyond the IDC dimples. At a maximum the insulation may extend to surface 'D'. See Figure 9

Figure 9 - Wire Insertion Visual Requirements

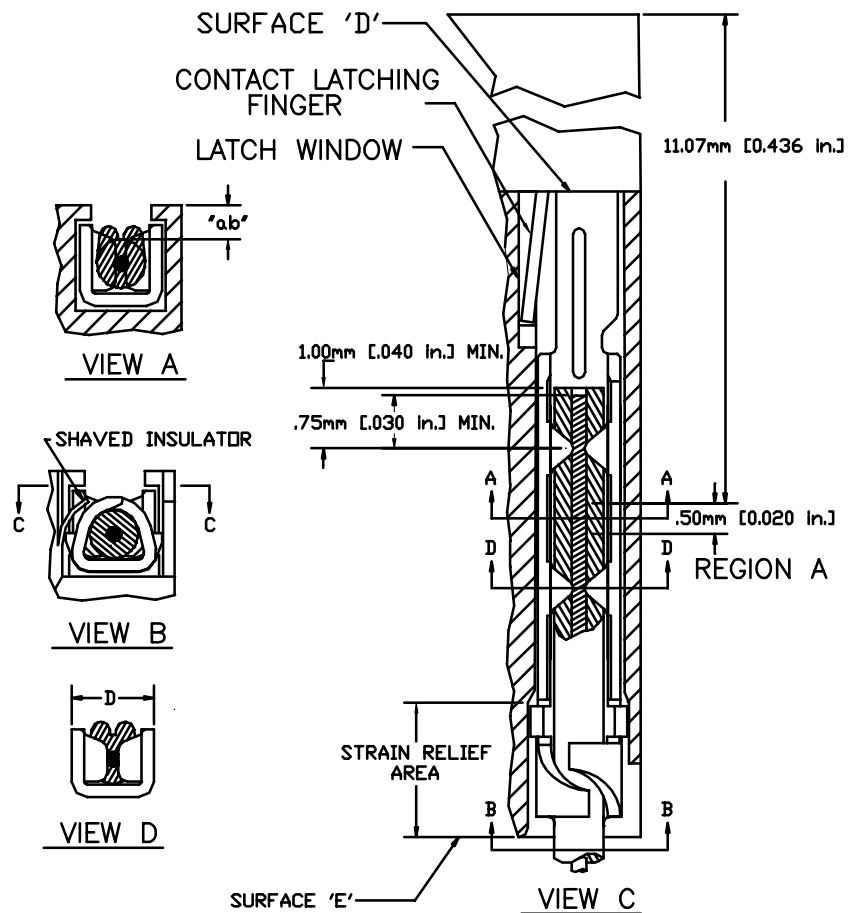

	TYPE APPLICATION SPECIFICATION	NUMBER GS-20-002	
	TITLE Specification of Requirements for Cable Preparation, Wire Termination and Assembly of Connectors Using 72392-type Contacts	PAGE 12 of 29	REVISION J
AUTHORIZED BY J.R. Volstorf		DATE 25-Apr-06	
STATUS UNRESTRICTED			

9.1.2 Wire Depth

The wire shall be inserted into the IDC dimples so that the wire depth is greater than or equal to “ab” as measured from the connector insulator to the top of the wire insulation in region “A” (Views A and C of Figure 9). A dial indicator (as depicted on Figure 2) can be used to measure the depth required. The minimum “ab” is based on the diameter of the wire being used. For insulation diameters greater or equal to 0.6mm [0.0236 inch], “ab” can be determined from the relation “ab” minimum = [(1.48 - O.D.) millimeters, (.058 - O.D.) inches]; where O.D. is the actual outside diameter of the insulation of the wire in question. For insulation diameters below 0.6mm [0.0236 inch] the minimum insertion depth is 0.88mm [0.0346 inch]. In the case where different size wires are being inserted on the same side of the insulator, “ab” shall be calculated from the largest wire insulation diameter.. Two insertion punches are available and the wire insulation diameter determines which one is used. See the section on “**Application Tooling**” for details.

For insulation diameters larger than 0.7mm [.0275 inch] it is possible to push on the wire with such pressure that the insulation spreads against the side of the contact walls in the IDC area and opens up the contact. For these diameters measure the distance “D” across the IDC channel at either IDC dimple as shown in view D of figure9 with the wire inserted. Open the wire strain relief and gently remove the inserted wire. Again measure distance “D” at the same spot. The measurement with the wire removed should be at least .05mm [.002 inch] less than with the wire inserted. This measurement should be done when the insertion equipment is set up. If the measurement is less than specified, reduce the depth of insertion until it is meet. Contact you FCI representative if the wire you selected cannot meet all requirements.

A standard depth gage is available for the measurement of “ab” as listed below. We have observed that with some wire insulation types, the insulation gradually lifts off the wire after insertion. For this reason, the measurement of wire depth “ab” should be made as soon after insertion as possible to avoid incorrect low readings.

Dial Indicator Insertion Depth Gage			
FCI Part No.	Scale	Travel per Revolution	Graduations
413395-001	Millimeters	1.00	0.01

Figure 10 - Wire Depth Gage

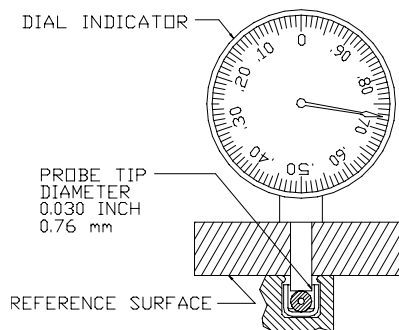

	TYPE	APPLICATION SPECIFICATION		NUMBER	GS-20-002		
	TITLE	Specification of Requirements for Cable Preparation, Wire Termination and Assembly of Connectors Using 72392-type Contacts		PAGE	13 of 29	REVISION	J
				AUTHORIZED BY	J.R. Volstorf	DATE	25-Apr-06
				STATUS	UNRESTRICTED		

9.1.3 Strain Relief

All strain relief tabs must be crimped firmly against the wire such that the wire will not be dislodged with a 8.9N (2 lb.) minimum pull. The wire shall be pulled at 90 degrees to the axis of the terminated wire, in a direction opposite to the insertion direction. It should be considered a major defect if either of the contact strain relief tabs have not been crimped over the wire.

9.1.4 IDC Terminal Damage

There should be no distortion of the metal terminal other than the intended forming of the strain relief except that the insertion punch may cut into the face of the IDC dimple a maximum of 0.1 millimeter (0.004 inches) during wire insertion.

9.1.5 Wire Damage

There shall be no breaks in the wire insulation to expose the center conductor below surface "E" in Figure 14 , View C. Marks and dents in the insulation caused by the insertion equipment that do not expose the conductor in this area are permitted.

9.2 Tool Setup and Destructive Inspection Techniques

Techniques to verify proper tool set-up and for further inspection of suspected visual failures require wire removal. Wire removal shall be done in accordance with the following instructions.

9.2.1 Wire Removal

Force open the wire strain reliefs of the contact and peel the wire away from the strain relief (up in Figure 14, View B) and out of the IDC dimples, being careful not to damage the contact.

9.2.2 IDC Terminal Damage

Examine the IDC dimples. There shall be no visible damage other than that caused by the intended forming of the strain relief and the normal widening of the IDC gap by the wire except that the insertion punch may cut into the face of the IDC dimple a maximum of 0.10 millimeters (0.004 inches) during wire insertion.

9.2.3 Acceptable Metallic Contact

The removed wire shall show evidence of metallic contact with all four IDC dimples.

10.0 CONNECTOR SUB-ASSEMBLIES - GENERAL

10.1 Contact Retention

Contacts shall be held securely in the insulator and be capable of withstanding a 13.4N (3.0 lb.) axial pull. A contact which becomes dislodged at an axial force of less than 8.9N (2.0 lb.) will be considered a major defect.

	TYPE	APPLICATION SPECIFICATION		NUMBER	GS-20-002			
	TITLE	Specification of Requirements for Cable Preparation, Wire Termination and Assembly of Connectors Using 72392-type Contacts			PAGE	14 of 29	REVISION	J
				AUTHORIZED BY	J.R. Volstorf		DATE	25-Apr-06
				STATUS	UNRESTRICTED			

10.2 Connector Insulator Damage

10.2.1 Termination Tool Misalignment

Slight misalignment between the connector and the wire insertion blade will cause shaving of plastic in the strain relief area of the connector (Figure 9, View B). Slight (0.1mm , 0.004 inch) shaving of the insulator in this region is acceptable if all other requirements of section "ACCEPTABLE WIRE TERMINATIONS" are met and if all strain relief tabs are crimped onto the wire.

10.3 Wire Terminators

The following coded wire termination tools are available for inserting wires into the connectors.

Wire Insertion Equipment				
FCI Part No.	Description	Function	Instructions	Comments
413053-010	TL-230	Auto. Terminator	413054-001	110 VAC
413053-011	TL-230	Auto .Terminator	413054-001	220 VAC
BPY6737PC1xx		Auto .Terminator		
BPY13836		Hand Tool		Pistol grip

10.3.1 Automatic Terminators

The terminators are semi-automatic wire inserters that can handle all sizes of the connectors. The terminators wire insertion punches can be adjusted to meet depth requirements on all approved wire sizes and insulation sizes and types. All terminators are self indexing and can insert two wires simultaneously. The terminators can be programmed to insert all positions, insert on one side only or skip positions. Multiple programs can be stored for different cable assemblies on the terminator and recalled by program number.

The TL-230 automatic terminator uses two different insertion punches. The punch you use is determined by the outside diameter of the wire insulation. In the case where bare drain wires are being inserted along with insulated wires, the punch used will depend on the diameter of the insulated wire. The punches are very similar but can be identified by the part number etched on the sides. On the punches for the TL-230, punch 166981-005 replaces the 166981-002. The 166981-005 punch produces a better connection on wires with insulation diameters above 0.8mm

Insertion Equipment	Insertion Punch	Wire Insulation Diameter
TL-230	166981-005	0.6 - 1.0mm [0.024 - 0.040inch]
TL-230	166981-003	0.4 - 0.7mm [0.016 - 0.028inch]

	TYPE APPLICATION SPECIFICATION	NUMBER GS-20-002	
	TITLE Specification of Requirements for Cable Preparation, Wire Termination and Assembly of Connectors Using 72392-type Contacts	PAGE 15 of 29	REVISION J
AUTHORIZED BY J.R. Volstorf		DATE 25-Apr-06	
STATUS UNRESTRICTED			

Figure 11 TL-230 Automatic Terminator



The BPY6737A3xx automatic terminator uses two different adapter kits. Which kit you use depends on the cable connector you are using. The 'xx' in the terminator number specifies the keyboard type. There are three versions, 'UK', 'FR' or 'SW'

Kit Number	For Cable Connectors
BPY6736A1	72476 and 72477

	TYPE APPLICATION SPECIFICATION	NUMBER GS-20-002	
TITLE Specification of Requirements for Cable Preparation, Wire Termination and Assembly of Connectors Using 72392-type Contacts	PAGE 16 of 29	REVISION J	
	AUTHORIZED BY J.R. Volstorf	DATE 25-Apr-06	
STATUS UNRESTRICTED			

Figure 12 BPY6737PC1xx Automatic Terminator



10.3.2 Hand Tools

The hand tool is a pistol grip ratchet type manual inserter. The insertion punch of the hand tool can be adjusted for controlling insertion depth and once activated must complete the entire insertion cycle before returning. The punch is mechanically advanced and spring returned and the connector sub-assembly is manually advanced and retracted from the tool. The hand tool inserts one wire at a time.

Figure 13 Hand Tool Terminator



	TYPE APPLICATION SPECIFICATION	NUMBER GS-20-002	
	TITLE Specification of Requirements for Cable Preparation, Wire Termination and Assembly of Connectors Using 72392-type Contacts	PAGE 17 of 29	REVISION J
AUTHORIZED BY J.R. Volstorf		DATE 25-Apr-06	
STATUS UNRESTRICTED			

11.0 ASSEMBLY OF COMPONENTS AFTER WIRE INSERTION

11.1 72476 and 72477 type Metra™ Unshielded Connectors

11.1.1 Assembly of Covers to Connector Sub-Assemblies

The two cover halves are pressed together trapping the connector sub-assemblies with the inserted cable wires between the two halves. The connector sub-assemblies must be aligned so that the side with the smaller diameter but longer stud faces the latch side cover. The force required to press the two halves together is such that a fixture is needed. The covers can be disassembled and reassembled up to three times if repairs are needed. After assembly check to see that the small separator ribs on the covers that go between the insulators (connector sub-assemblies) are actually between the insulators and not smashed down under the side of the insulators.

FCI Part No.	Drawing No.	Description	Instructions
HT-0520	415810-001	Cover Assembly Fixture	415835-001

Figure 14 Assembly of Covers - 72476 type Connectors

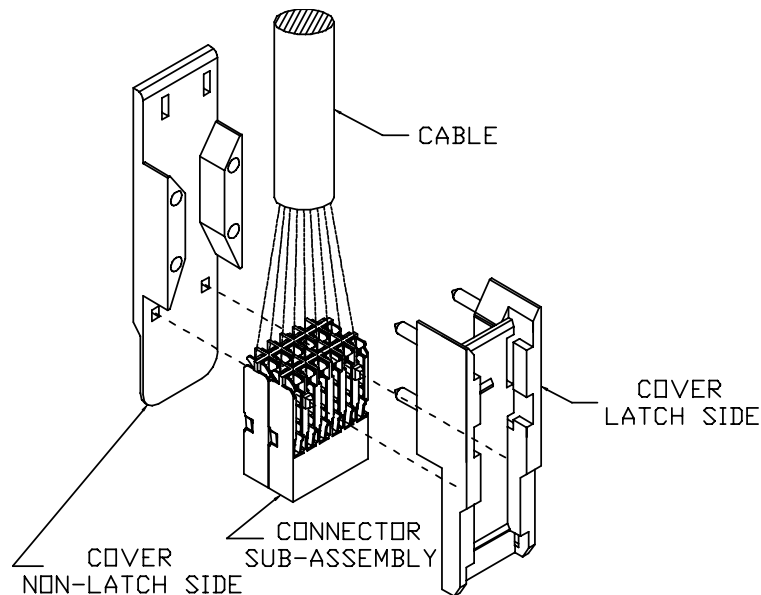

	TYPE APPLICATION SPECIFICATION	NUMBER GS-20-002	
	TITLE Specification of Requirements for Cable Preparation, Wire Termination and Assembly of Connectors Using 72392-type Contacts	PAGE 18 of 29	REVISION J
AUTHORIZED BY J.R. Volstorf		DATE 25-Apr-06	
STATUS UNRESTRICTED			

Figure 15 Assembly of Covers - 72477 type Connectors

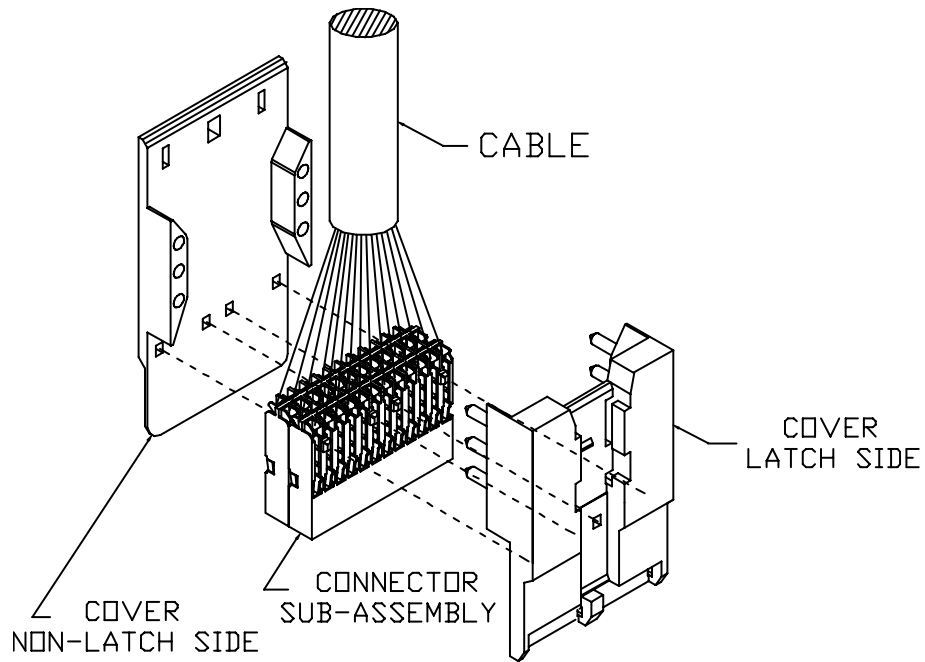
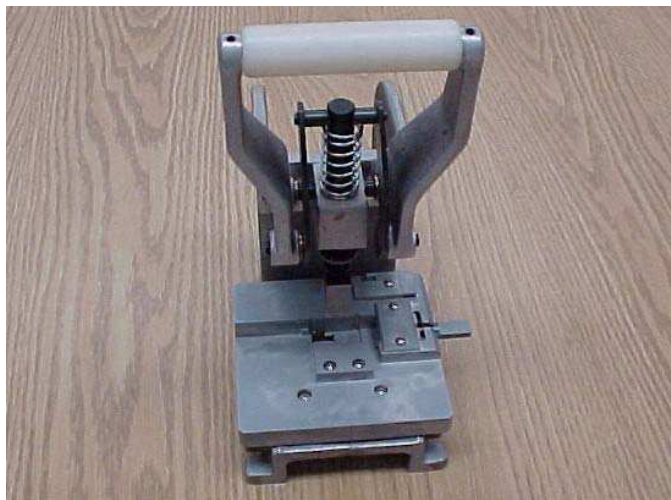



Figure 16 Cover Assembly Fixture



	TYPE APPLICATION SPECIFICATION	NUMBER GS-20-002	
	TITLE Specification of Requirements for Cable Preparation, Wire Termination and Assembly of Connectors Using 72392-type Contacts	PAGE 19 of 29	REVISION J
AUTHORIZED BY J.R. Volstorf		DATE 25-Apr-06	
STATUS UNRESTRICTED			

11.1.2 Assembly of Latch Finger to Covers

The assembly of the latch finger to a cover is show drawn below. The latch finger may also be assembled and before or after assembly of the optional coding keys.

Figure 17 Assembly of Latch Finger

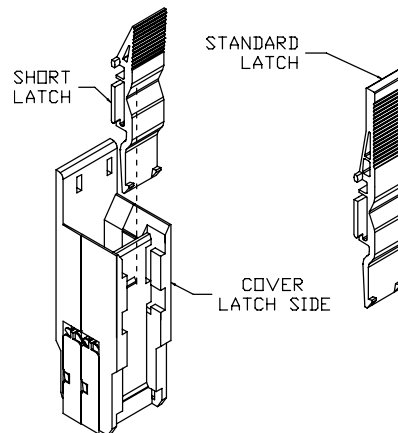

11.1.3 Assembly of Cable Tie

The band of the cable tie is threaded through the holes on the non-latch side cover and around the cable as shown. Then pull the tie band tight and cut the excess band flush to the tie head. Position the head of the tie so that it remains within the projected area of the covers and that it does not block insertion of adjacent connectors. In the case of cable assemblies specifying connectors with the regular latch finger, the tie head must be positioned so that it does not interfere with the action of the latch finger.

Figure 18 Assembly of Cable Tie

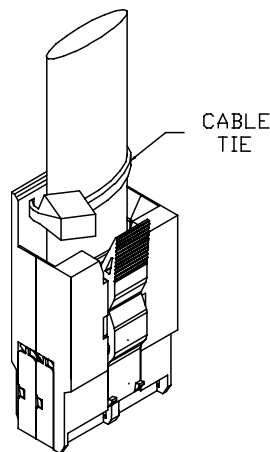

	TYPE APPLICATION SPECIFICATION	NUMBER GS-20-002	
	TITLE Specification of Requirements for Cable Preparation, Wire Termination and Assembly of Connectors Using 72392-type Contacts	PAGE 20 of 29	REVISION J
AUTHORIZED BY J.R. Volstorf		DATE 25-Apr-06	
STATUS UNRESTRICTED			

11.1.4 Assembly of Optional Coding Keys to Covers

The assembly of the 72388 type coding keys to the connector assembly is shown below. The cable is not shown. The coding keys may also be inserted in the latch side cover before latch finger or connector final assembly. The 72388 coding key is designed to work with the 5-row Metral™ Header coding key 70274. There are 18 coding key variations. Thus a 4x6 cable connector has 18 variations and a 4x12 cable connector can have up to 18x18 variations. The keys match on the part dash number so 72388-004 works with 70274-004.

Figure 19 Assembly of Coding Keys

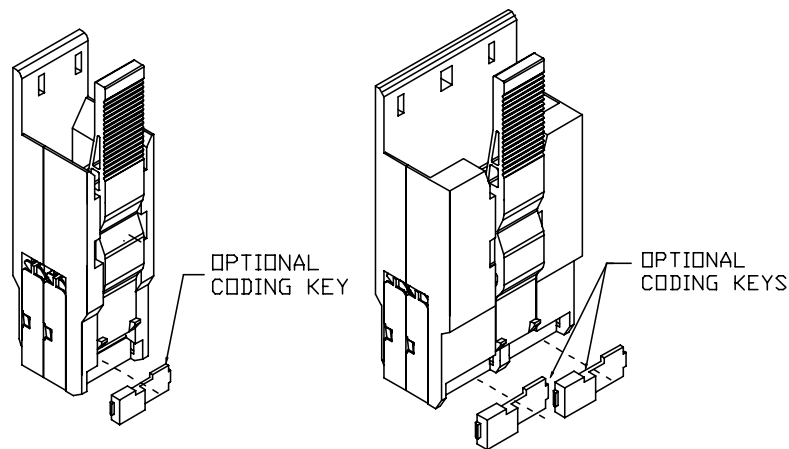

11.2 88940 type Metral™ Unshielded Connectors

No additional assembly required after wire insertion.

	TYPE	APPLICATION SPECIFICATION		NUMBER	GS-20-002			
	TITLE	Specification of Requirements for Cable Preparation, Wire Termination and Assembly of Connectors Using 72392-type Contacts			PAGE	21 of 29	REVISION	J
				AUTHORIZED BY	J.R. Volstorf		DATE	25-Apr-06
				STATUS	UNRESTRICTED			

12.0 REPAIR PROCEDURES

12.1 Repair Tooling

The HT-0522 contact removal kit contains one HT-0523 contact removal tool and a holding fixture. The holding fixture is needed to remove contacts on the connector sub-assembly end positions with the exposed contact latch fingers. There are two of these positions per connector sub-assembly on the unshielded cable connectors. The shielded cable connectors do not require the holding fixture and need only the HT-0522 contact removal tool. The HT-0525 wire insertion repair tool will insert wire with only a short remaining lead into a unused contact. If the contact into which the wire is to be inserted has been used previously, then it must be replaced with an unused contact before insertion. The HT-0517 latch finger removal tool removes an already installed latch finger from the connector assembly.

FCI Part No.	Drawing No.	Description	Instructions
HT-0522	415832-001	Contact Removal Kit	415837-001
HT-0523	415826-001	Contact Removal Hand Tool	415837-001
HT-0524	415821-001	Wire Insertion repair Tool	415838-001
HT-0517	415709-001	Latch Finger Removal Tool	415708-001

12.2 Wire Replacement

No testing has been done on the reliability of contacts that have been repaired (wire removed and replaced). Contacts with improperly inserted or incorrect wires should be removed and replaced.

12.3 Damaged Contacts in a Completed Connector

Damaged contacts must be removed from the connector and replaced.

12.4 Removing Contacts from the Insulator

Contacts are removed by inserting the contact removal tool, HT-0523 into the lock window in the insulator and deforming the lock tab (Figure 19, View C) in away from the window. This allows the contact to slide out through the back of the insulator (down in Figure 19, View C). If the contact is to be reinserted, then the contact must be remove carefully so as to not bend or deform the contact. The contact must also be protected from damage until it is reinserted.

12.5 Inserting Contacts into the Insulator

Carefully insert the contact into the desire insulator position. Check the orientation of other contacts in the insulator and orient the contact to be inserted the same before beginning insertion. Replacement contacts can be obtained by removing a contact from an identical connector sub-assembly (match part numbers printed on connector sub-assembly) or by the following special replacement contacts.

FCI Part No.	Description	For Wire Gages
84899-401	4-row Contact, 2.0um Au	26-24
84899-402	4-row Contact, 2.0um Au	30-26

	TYPE APPLICATION SPECIFICATION	NUMBER GS-20-002	
	TITLE Specification of Requirements for Cable Preparation, Wire Termination and Assembly of Connectors Using 72392-type Contacts	PAGE 22 of 29	REVISION J
		AUTHORIZED BY J.R. Volstorf	DATE 25-Apr-06
		STATUS UNRESTRICTED	

The contact must be fully seated so that the latch finger snaps into the locking window and holds the contact in place. The following figure shows the visual inspection needed to determine that the contact is properly latched in the insulator.

Figure 20 Checking for Proper Contact Latching After Insertion

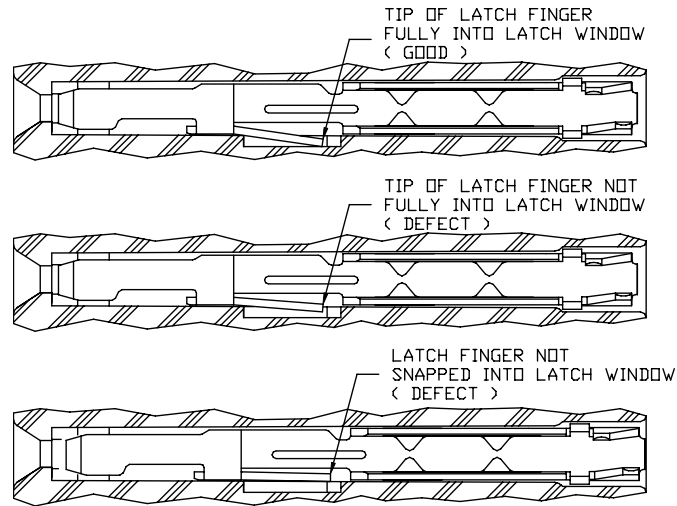

The following figure demonstrates the visual inspection procedure to check that the contact is properly aligned in the insulator. This visual inspection requires the aid of at least a 10x magnification lens. The reason the shown defect is named a “blackeye” is that it prevents light from passing through from the IDC side of the insulator to the pin window side. On a good contact, insertion light can pass through the contact tip gap.

Figure 21 Checking for Damaged Terminal After Insertion

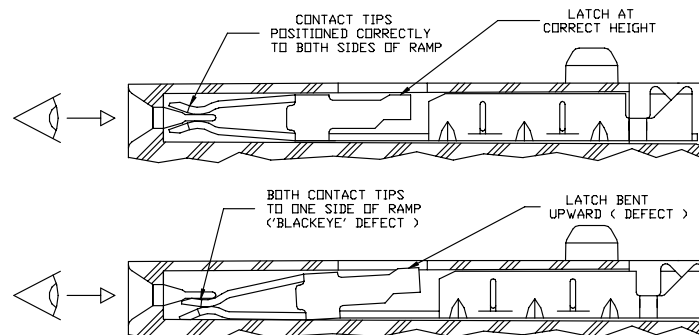

12.6 Wires Inserted in Wrong Position or Defective Insertion

12.6.1 Preferred Method of Repair

The preferred method of repair is to cutoff the defective connector sub-assemblies from the cable just above the connectors, strip the end of the cable and insert the wires into new connector sub-assemblies.

	TYPE APPLICATION SPECIFICATION	NUMBER GS-20-002	
	TITLE Specification of Requirements for Cable Preparation, Wire Termination and Assembly of Connectors Using 72392-type Contacts	PAGE 23 of 29	REVISION J
AUTHORIZED BY J.R. Volstorf		DATE 25-Apr-06	
STATUS UNRESTRICTED			

12.6.2 Alternate Methods of Repair

12.6.2.1 Wires Inserted in Wrong Position

Remove the inserted contact using contact removal kit HT-0522 being careful not to damage the contact or disturb the wire at the IDC's. In some cases the amount of free wire between the connector sub-assembly and the cable jacket is too short to back the contact out of the insulator. In this case the cable jacket will have to be slit higher to free more wire length to accomplish the task. After removal carefully reinsert the contacts in the correct positions. Another method would be to remove all contacts in the insulator at the same time which does not require slitting the cable jacket and reinserting all the contacts also at the same time. This latter method is not recommended since it is very hard to properly reinsert all the contacts at the same time.

12.6.2.2 Defective Insertions

12.6.2.2.1 Reinsertion of Wire in IDC of Contact

Remove the inserted contact with contact removal kit HT-0522. Replace the contact with a new contact. The preferred method is to cut the wire outside the contact but if this does not leave a long enough wire for reinsertion then the strain relief of the contact can be opened and the wire removed. After removal of the wire cut off the end of the wire just before were the first IDC dimple had contacted the wire as shown in the following figure. Reinsert the end of the wire using wire insertion repair tool HT-05254 The reinserted wire must meet all the requirements listed for normal wire insertion.

Figure 22 Preparing Wire for Reinsertion

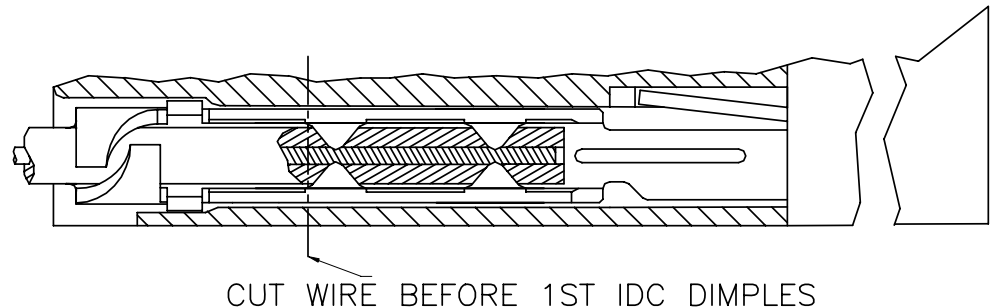



	TYPE APPLICATION SPECIFICATION	NUMBER GS-20-002	
	TITLE Specification of Requirements for Cable Preparation, Wire Termination and Assembly of Connectors Using 72392-type Contacts	PAGE 24 of 29	REVISION J
AUTHORIZED BY J.R. Volstorf		DATE 25-Apr-06	
STATUS UNRESTRICTED			

Figure 23 HT-0525 Wire Insertion Repair Tool



Figure 24 BPY75D37 Wire Insertion Repair Tool





	TYPE APPLICATION SPECIFICATION	NUMBER GS-20-002	
	TITLE Specification of Requirements for Cable Preparation, Wire Termination and Assembly of Connectors Using 72392-type Contacts	PAGE 25 of 29	REVISION J
AUTHORIZED BY J.R. Volstorf		DATE 25-Apr-06	
STATUS UNRESTRICTED			

12.6.2.2.2 Soldering of Wire in Contact

Remove the inserted contact with contact removal kit HT-0522. Replace the contact with a new contact. The preferred method is to cut the wire outside the contact but if this does not leave a long enough wire for reinsertion then the strain relief of the contact can be opened and the wire removed. After removal of the wire cut the end of the wire just before where the first IDC dimple had contacted the wire as shown in the above figure. Remove the insulation from the wire such that after reinsertion the wire is positioned in the contact as shown in the following figure. Reinsert the wire using the contact wire insertion repair tool HT-0524 setting the strain relief and carefully solder the wire to the contact IDC channel at the first set of IDC dimples or between sets of IDC dimples. The soldering operation must be done as quickly as possible to prevent damage to the insulator. Do not allow solder to protrude above the contact as shown in the following figure. Only certified soldering operators should be used to make these repairs.

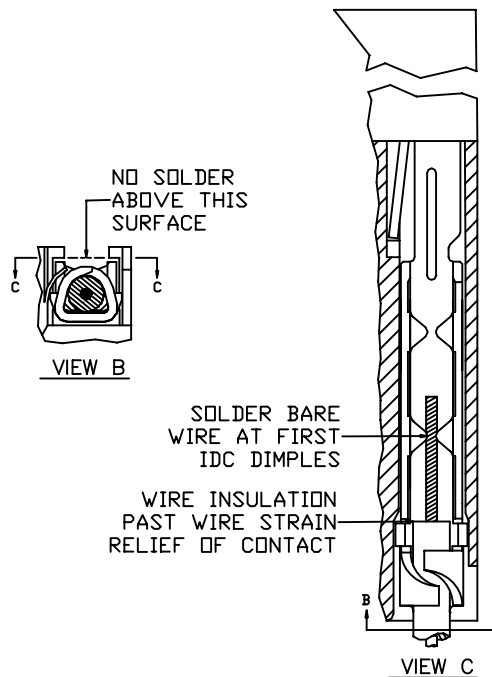
Figure 25 Solder Repair of Defective Insertion



	TYPE APPLICATION SPECIFICATION	NUMBER GS-20-002	
	TITLE Specification of Requirements for Cable Preparation, Wire Termination and Assembly of Connectors Using 72392-type Contacts	PAGE 26 of 29	REVISION J
AUTHORIZED BY J.R. Volstorf		DATE 25-Apr-06	
STATUS UNRESTRICTED			

12.7 Replacing Latches

This procedure covers both the replacement of broken or defective latch fingers as well as the wrong latch finger having been assembled. In both cases the old latch finger is destroyed in the process and cannot be reused. Remove the old latch finger using the latch finger removal tool, HT-0517. After the old latch finger is removed, check the latch finger track in the latch side covers for damage to the cover and for remaining pieces of the latch finger. Remove the remaining pieces of the old latch fingers if present. Assemble the new latch finger per instructions in section on component assembly.

12.8 Replacing or Removing Covers

Pry the two covers apart taking care not to damage the cable or connector sub-assemblies. If undamaged, covers may be reused up to three times. If one or more of the covers are damaged, replace with new covers. Reassemble covers per instructions in section on component assembly. If, due to the repair having to be made in a remote location, it is not feasible to have a cover assembly fixture (HT-0520), the covers can be pressed together using a small vise or mallet but great care must be taken to align the connector sub-assemblies to the covers to get a good assembly.

13.0 Use of Connectors with Mating Products

13.1 72476 and 72477 type Metral™ Unshielded Connectors

The cable connectors mate with all standard Metral™ 4-row headers and shrouds. Multiple cable connectors may be plugged into one header or in the case of the 72477, the cable connector can be plugged into two 4x6 headers. The cable connectors are end-to-end stackable and can be spaced within 16mm side-to-side. All connectors can mate with the following range of pin heights.

Figure 26 Mating Headers & Shrouds

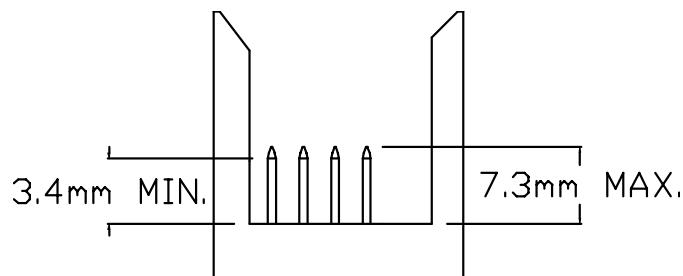

13.2 88940 type Metral™ Unshielded Connectors

These connectors can be used only for rear plug-up to straight Metral™ four row headers. Three varieties of press-on retainers are available for this purpose. The retainers press onto the header pins so no extra features are required on the board. In all cases two connectors must be placed side-to-side in the retainers to effect latching. The retainers and thus the connectors are end-to-end stackable. All connector can mate with the following range of pin heights.



	TYPE APPLICATION SPECIFICATION	NUMBER GS-20-002	
TITLE Specification of Requirements for Cable Preparation, Wire Termination and Assembly of Connectors Using 72392-type Contacts		PAGE 27 of 29	REVISION J
		AUTHORIZED BY J.R. Volstorf	DATE 25-Apr-06
		STATUS UNRESTRICTED	

Figure 27 Mating Retainers

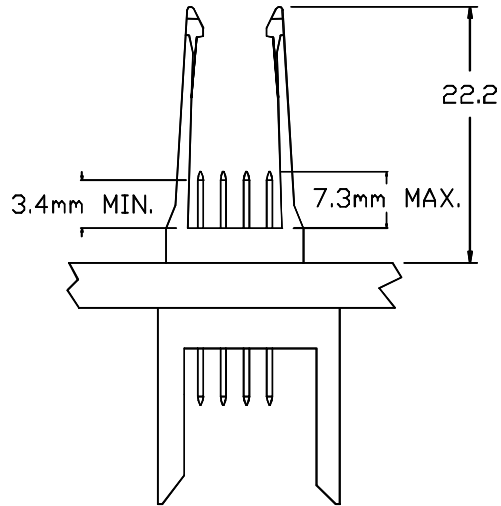

	TYPE APPLICATION SPECIFICATION	NUMBER GS-20-002	
	TITLE Specification of Requirements for Cable Preparation, Wire Termination and Assembly of Connectors Using 72392-type Contacts	PAGE 28 of 29	REVISION J
AUTHORIZED BY J.R. Volstorf		DATE 25-Apr-06	
STATUS UNRESTRICTED			

14.0 NOTES

The following table lists the cad files imported into this document.

Figure	Autocad File
1	G20002_A.DWG
2	G20002_B.DWG
3	G20002_C.DWG
4	G20002_D.DWG
5	G20002_E.DWG
6	G20002_F.DWG
7	G20002_G.DWG
8	G20002_H.DWG
9	G20002_J.DWG
10	G20002_K.DWG
11	G20003_T.JPG
12	G20003_U.JPG
13	G20003_V.JPG
14	G20002_L.DWG
15	G20002_M.DWG
16	G20003_Y.JPG
17	G20002_N.DWG
18	G20002_P.DWG
19	G20002_R.DWG
20	G20002_S.DWG
21	G20002_T.DWG
22	G20002_U.DWG
23	G20003AH.JPG
24	G20003AJ.JPG
25	G20002_V.DWG
26	G20002_W.DWG
27	G20002_X.DWG

15.0 NOTES

The following table lists the files of the pictures imported into this document.

16.0 REFERENCE DOCUMENTS

Bellcore GR-1217-CORE, IEC-1076-4-110

	TYPE	APPLICATION SPECIFICATION		NUMBER	GS-20-002			
	TITLE	Specification of Requirements for Cable Preparation, Wire Termination and Assembly of Connectors Using 72392-type Contacts			PAGE	29 of 29	REVISION	J
				AUTHORIZED BY	J.R. Volstorf		DATE	25-Apr-06
				STATUS	UNRESTRICTED			

REVISION RECORD

REV	PAGE	DESCRIPTION	EC #	DATE
A	ALL	NEW DOCUMENT	V-71213	09-03-97
B	ALL	ADD IDC SPRING BACK REQUIREMENTS	V-80308	02-12-98
C	ALL	ADD VISUAL AIDS ON CONTACT REPLACEMENT	V-81232	06-19-98
D	ALL	ADD CAMS AND REPAIR INFORMATION	V-90139	01-29-99
F	ALL	CHANGE 10.3 APP. TOOLING WIRE INSERT EQUIP. CHART	V12111	08/23/01
G	ALL	UPDATE INFO ON HAND TOOLS & ALTERNATE AUTO-INSERTER	V03-1138	10-20-03
H	ALL	ADD LEAD FREE INFORMATION	V05-0944	10-06-05
J	ALL	CHANGE LOGO	V06-0404	04/25/06