

LOC	DIST	REVISIONS				
P	LTR	DESCRIPTION	DATE	DWN	APVD	
E	B	BA	NEW RELEASE	11-NOV-08	SM	St.P

FOR FURTHER INFORMATION SEE DATA SHEET FOR  
CRG SERIES-THICK FILM CHIP RESISTORS

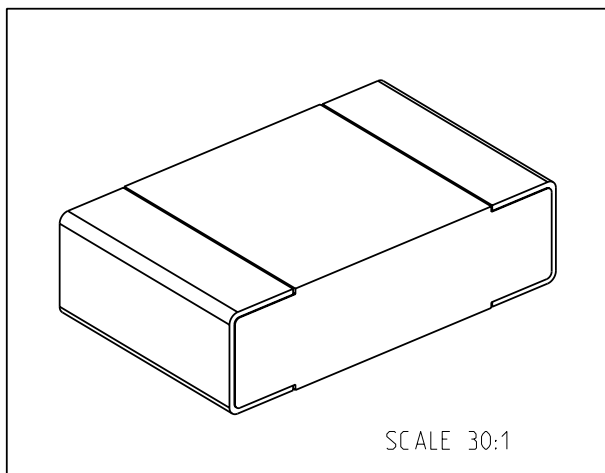
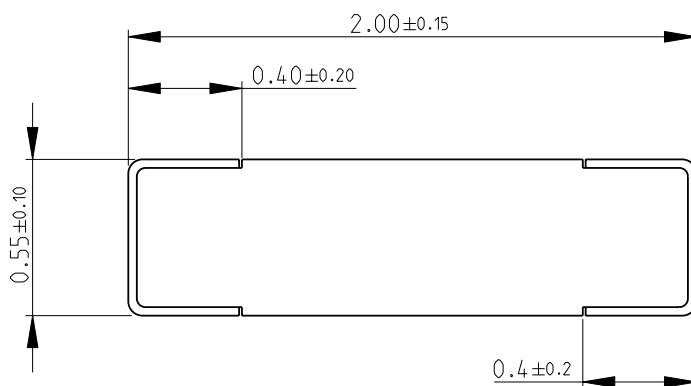

RoHS Compliant

2008

RELEASED FOR PUBLICATION

THIS DRAWING IS UNPUBLISHED.

© COPYRIGHT 2008 BY TYCO ELECTRONICS CORPORATION. ALL RIGHTS RESERVED.

DIMENSIONS: mm	DWN	SUBHASH.M	11-NOV-08	MATERIAL	-	FINISH	-
	CHK	PRAKASH.S	11-NOV-08	Tyco Electronics Corporation Dorcan, Swindon, SN3 5HH			
TOLERANCES UNLESS OTHERWISE SPECIFIED:	APVD	STEPHEN.P	11-NOV-08				
0 PLC ±0.5	PRODUCT SPEC	-	NAME	THICK FILM CHIP RESISTORS SERIES CRG 0805			
1 PLC ±0.2	APPLICATION SPEC	-	SIZE	CAGE CODE	DRAWING NO	RESTRICTED TO	
2 PLC ±0.1			A 4	00779	© = 1623132	-	
3 PLC ±	WEIGHT	-	CUSTOMER DRAWING		SCALE	SHEET	OF
4 PLC ±					40:1	1	1
ANGLES ±5°					REV	BA	