

SHOWN WITH DUST CAP
INSTALLED (NO MODULE)

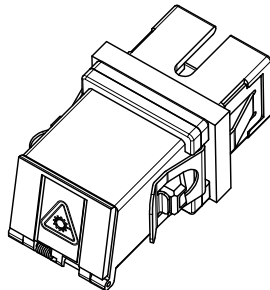

SC-SC VERSIONS
SEE SHEET 3

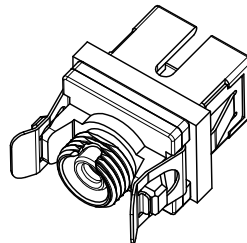

SC-FC VERSIONS
SEE SHEET 4

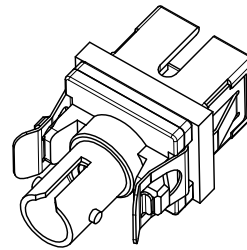

SC-ST VERSIONS
SEE SHEET 5

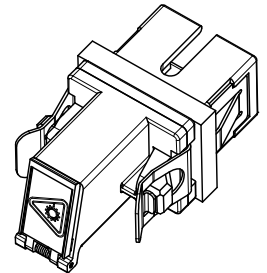

SC-LC VERSION
SEE SHEET 6

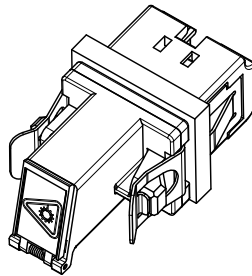

LC-LC VERSIONS
SEE SHEET 7

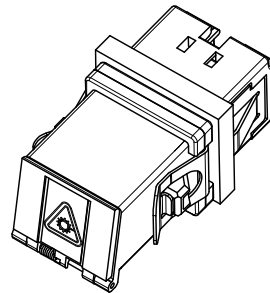

LC-SC VERSION
SEE SHEET 8

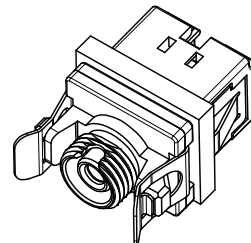

LC-FC VERSION
SEE SHEET 9

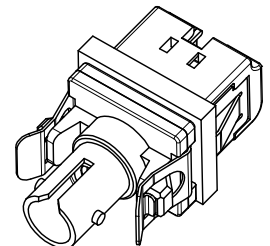

LC-ST VERSION
SEE SHEET 10

ENTER DESCRIPTION EC NO: MF2010-0212 DRAWN: SERNST CHKD: SMIGO APPR: SMIGO 2009/11/09 2009/11/11 2009/11/11	QUALITY SYMBOLS ▽=0 ▽=0	GENERAL TOLERANCES (UNLESS SPECIFIED)		DIMENSION STYLE MM/IN	SCALE 2.5:1	DESIGN UNITS METRIC	THIRD ANGLE PROJECTION		
		4 PLACES ± --- ± --- 3 PLACES ± --- ± --- 2 PLACES ± --- ± --- 1 PLACE ± --- ± ---	mm INCH	DRAWN BY SERNST	DATE 2006/02/13	TITLE UNIVERSAL EMI ADAPTER			
		ANGULAR ± 1 °		CHECKED BY DSZILAGYI	DATE 2006/03/07	MOLEX INCORPORATED			
		DRAFT WHERE APPLICABLE MUST REMAIN WITHIN DIMENSIONS		APPROVED BY SMIGO	DATE 2006/03/07	MATERIAL NO. SEE TABLES	DOCUMENT NO. SD-106154-001	SHEET NO. 1 OF 10	

MODULE P/N	TYPE	COLOR
1061540020	SC	BLUE
1061540022		BEIGE
1061540025		GREEN
1061540031	FC	BLUE
1061540033		BEIGE
1061540036		GREEN
1061540041	ST	BLUE
1061540043		BEIGE
1061540130	LC	BLUE
1061540131		BEIGE
1061540132		GREEN

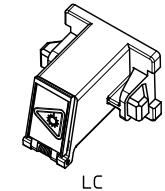
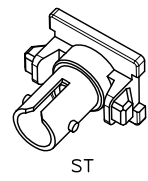
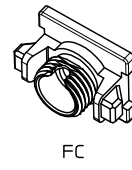
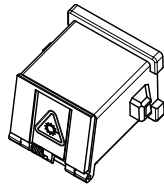

BASE P/N	TYPE	SLEEVE MAT'L	TYPE
1061540010	SINGLE MODE	ZIRCONIA	SC BASE TO 2.5mm
1061540012	MULTIMODE	PHOS BRONZE	SC BASE TO 2.5mm
1061540013	SM/MM	NICKEL	SC BASE TO 1.25mm
1061540210	SINGLE MODE	ZIRCONIA	LC BASE TO 1.25mm
1061540212	MULTIMODE	PHOS BRONZE	LC BASE TO 1.25mm
1061540213	SM/MM	NICKEL	LC BASE TO 2.5mm

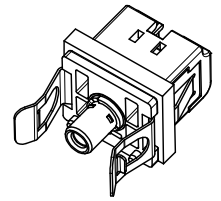
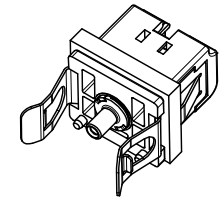
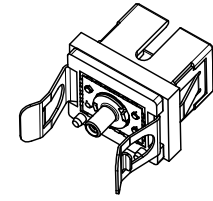
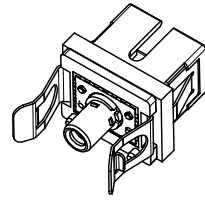

SLEEVE ASBY	TYPE	SLEEVE MAT'L	TYPE
1061540050	SINGLE MODE	ZIRCONIA	2.5mm
1061540051	MULTIMODE	PHOS BRONZE	2.5mm
1061540052	SINGLE MODE	ZIRCONIA	1.25mm
1061540053	MULTIMODE	PHOS BRONZE	1.25mm
1061540054	SM/MM	NICKEL	HYBRID 1.25 TO 2.5mm



DUST CAP
P/N 1061540006

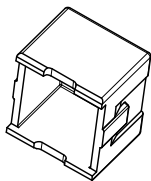

ENTER DESCRIPTION EC NO: MF2010-0212 DRAWN: SERNST CHKD: DSZILAGYI APPR: SMIGO	QUALITY SYMBOLS ▽=0 ▽=0	GENERAL TOLERANCES (UNLESS SPECIFIED)		DIMENSION STYLE	SCALE	DESIGN UNITS	THIRD ANGLE PROJECTION	
				MM/IN	2:1	METRIC		
				DRAWN BY	DATE	TITLE		
				SERNST	2006/02/13	UNIVERSAL EMI ADAPTER		
A4 REV	DESCRIPTION	ANGULAR ± 1 °		CHECKED BY	DATE	MATERIAL NO.		
				DSZILAGYI	2006/03/07	SMIGO		
				APPROVED BY	DATE	DOCUMENT NO.		
				SMIGO	2006/03/07	MOLEX INCORPORATED		
		DRAFT WHERE APPLICABLE MUST REMAIN WITHIN DIMENSIONS		SEE TABLES		SD-106154-001		
		THIS DRAWING CONTAINS INFORMATION THAT IS PROPRIETARY TO MOLEX INCORPORATED AND SHOULD NOT BE USED WITHOUT WRITTEN PERMISSION						
				SIZE B		SHEET NO. 2 OF 10		

10 9 8 7 6 5 4 3 2 106154

ADAPTER P/N	STYLE	TYPE	SLEEVE MAT'L	MODULE COLOR
1061541000	SC-SC	SINGLE MODE	ZIRCONIA	BLUE
1061541005	SC-SC/APC			GREEN
1061541001	SC-SC	MULTIMODE	PHOSPHOR BRONZE	BEIGE

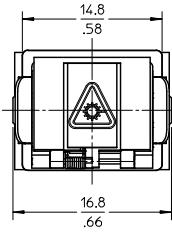
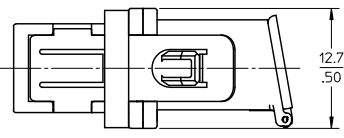
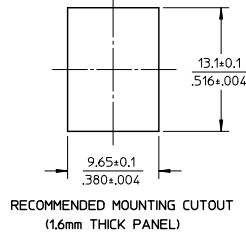
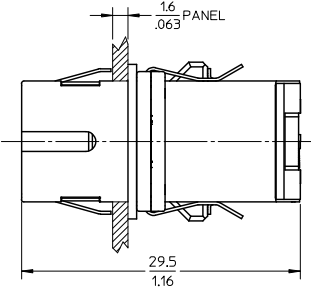

NOTES:
1. ALL DIMENSIONS ARE FOR REFERENCE ONLY.
2. PACKAGING: ADAPTERS AND DUSTCAPS ARE PACKED IN A PLASTIC TRAY.

ENTER DESCRIPTION EC NO: MF2010-0212 DRAWN: SERNST CHKD: CHYKD APPR: SMIGO 2009/11/09 2009/11/11 2009/11/11	QUALITY SYMBOLS ▽=0 ▽=0	GENERAL TOLERANCES (UNLESS SPECIFIED)		DIMENSION STYLE MM/IN	SCALE 2.5:1	DESIGN UNITS METRIC	THIRD ANGLE PROJECTION	
		mm	INCH	DRAWN BY SERNST	DATE 2006/02/13	TITLE UNIVERSAL EMI ADAPTER		
		4 PLACES ± --- ± ---		CHECKED BY DSZILAGYI	DATE 2006/03/07	MATERIAL NO. SEE TABLE		
		3 PLACES ± --- ± ---		APPROVED BY SMIGO	DATE 2006/03/07	DOCUMENT NO. SD-106154-001		
2 PLACES ± --- ± ---		ANGULAR ± 1 °		SIZE B		SHEET NO. 3 OF 10		
1 PLACE ± --- ± ---		DRAFT WHERE APPLICABLE MUST REMAIN WITHIN DIMENSIONS		THIS DRAWING CONTAINS INFORMATION THAT IS PROPRIETARY TO MOLEX INCORPORATED AND SHOULD NOT BE USED WITHOUT WRITTEN PERMISSION				

9 8 7 6 5 4 3 2 1

ADAPTER P/N	STYLE	TYPE	SLEEVE MAT'L	MODULE COLOR	KEY SIZE (mm)
1061541010	SC-FC	SINGLE MODE	ZIRCONIA	BLUE	2.3
1061541015	SC-FC/APC			GREEN	2
1061541011	SC-FC	MULTIMODE	PHOSPHOR BRONZE	BEIGE	2.3

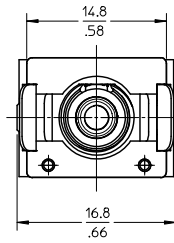
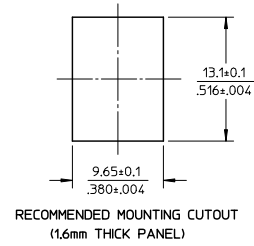
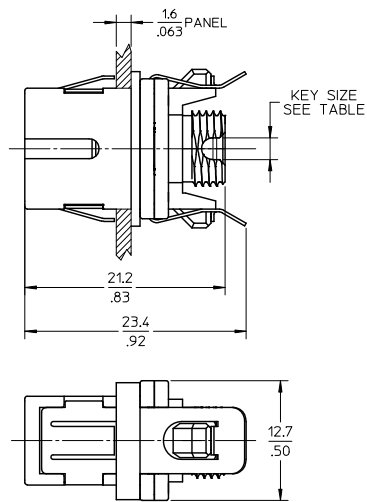

NOTES:
1. ALL DIMENSIONS ARE FOR REFERENCE ONLY.
2. PACKAGING: ADAPTERS AND DUSTCAPS ARE PACKED IN A PLASTIC TRAY.

ENTER DESCRIPTION EC NO: MF2010-0212 DRAWN: SERNST CHKD: CHYKD APPR: SMIGO 2009/11/09 2009/11/11 2009/11/11	QUALITY SYMBOLS	GENERAL TOLERANCES (UNLESS SPECIFIED) mm INCH 4 PLACES ± --- ± --- 3 PLACES ± --- ± --- 2 PLACES ± --- ± --- 1 PLACE ± --- ± --- ANGULAR ± 1 °	DIMENSION STYLE	SCALE	DESIGN UNITS	THIRD ANGLE PROJECTION
	▽=0 ▽=0		MM/IN	2.5:1	METRIC	
	DRAFT WHERE APPLICABLE MUST REMAIN WITHIN DIMENSIONS	DRAWN BY: SERNST DATE: 2006/02/13 CHECKED BY: DSZILAGYI DATE: 2006/03/07 APPROVED BY: SMIGO DATE: 2006/03/07	TITLE	UNIVERSAL EMI ADAPTER		
	A4	MATERIAL NO. SEE TABLE DOCUMENT NO. SD-106154-001 SHEET NO. 4 OF 10	MOLEX INCORPORATED THIS DRAWING CONTAINS INFORMATION THAT IS PROPRIETARY TO MOLEX INCORPORATED AND SHOULD NOT BE USED WITHOUT WRITTEN PERMISSION			

ADAPTER P/N	STYLE	TYPE	SLEEVE MAT'L	MODULE COLOR
1061541020	SC-ST	SINGLE MODE	ZIRCONIA	BLUE
1061541021		MULTIMODE	PHOS BRONZE	BEIGE

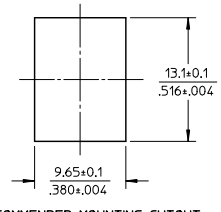
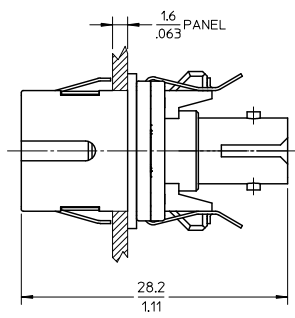

RECOMMENDED MOUNTING CUTOUT
(1.6mm THICK PANEL)

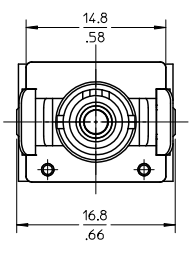
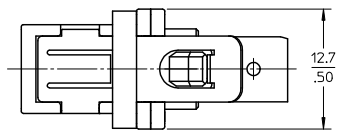

- NOTES:
- ALL DIMENSIONS ARE FOR REFERENCE ONLY.
 - PACKAGING: ADAPTERS AND DUSTCAPS ARE PACKED IN A PLASTIC TRAY.

ENTER DESCRIPTION EC NO: MF2010-0212 DRAWN: SERNST CHKD: DSZILAGYI APPR: SMIGO DATE: 2009/11/09 DATE: 2009/11/11 DATE: 2009/11/11	QUALITY SYMBOLS	GENERAL TOLERANCES (UNLESS SPECIFIED) mm INCH 4 PLACES ± --- ± --- 3 PLACES ± --- ± --- 2 PLACES ± --- ± --- 1 PLACE ± --- ± --- ANGULAR ± 1 °	DIMENSION STYLE	SCALE	DESIGN UNITS	THIRD ANGLE PROJECTION	
	▽=0 ▽=0		MM/IN	2.5:1	METRIC	DRAWN BY: SERNST DATE: 2006/02/13 CHECKED BY: DSZILAGYI DATE: 2006/03/07 APPROVED BY: SMIGO DATE: 2006/03/07	TITLE
	DRAFT WHERE APPLICABLE MUST REMAIN WITHIN DIMENSIONS		MATERIAL NO. SEE TABLE	DOCUMENT NO. SD-106154-001	SHEET NO. 5 OF 10	UNIVERSAL EMI ADAPTER MOLEX INCORPORATED	
	SIZE B THIS DRAWING CONTAINS INFORMATION THAT IS PROPRIETARY TO MOLEX INCORPORATED AND SHOULD NOT BE USED WITHOUT WRITTEN PERMISSION						

ADAPTER P/N	STYLE	TYPE	SLEEVE MAT'L	MODULE COLOR
1061541030	SC-LC	SM OR MM	NICKEL	BEIGE

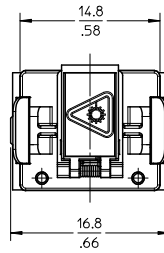
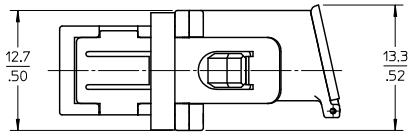
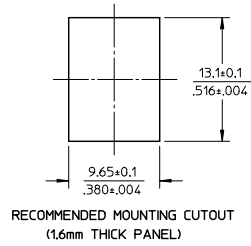
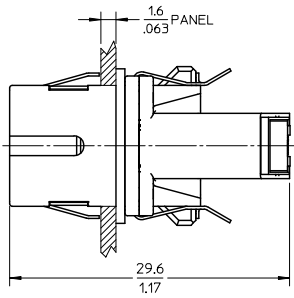

NOTES:
 1. ALL DIMENSIONS ARE FOR REFERENCE ONLY.
 2. PACKAGING: ADAPTERS AND DUSTCAPS ARE PACKED IN A PLASTIC TRAY.

ENTER DESCRIPTION EC NO: MF2010-0212 DRAWN: SERNST CHKD: CHYKD APPR: SMIGO	QUALITY SYMBOLS ▽=0 ▽=0	GENERAL TOLERANCES (UNLESS SPECIFIED)		DIMENSION STYLE	SCALE	DESIGN UNITS	THIRD ANGLE PROJECTION	
		mm	INCH	MM/IN	2.5:1	METRIC		
		4 PLACES ± --- ± ---		DRAWN BY	DATE	TITLE		
		3 PLACES ± --- ± ---		SERNST	2006/02/13	UNIVERSAL EMI ADAPTER		
2 PLACES ± --- ± ---		CHECKED BY	DATE	MOLEX INCORPORATED DOCUMENT NO. SD-106154-001 SHEET NO. 6 OF 10				
1 PLACE ± --- ± ---		DSZILAGYI	2006/03/07					
ANGULAR ± 1 °		APPROVED BY	DATE					
DRAFT WHERE APPLICABLE MUST REMAIN WITHIN DIMENSIONS		SMIGO	2006/03/07					
REV A4	DESCRIPTION	MATERIAL NO.		SEE TABLE				
		SIZE B		THIS DRAWING CONTAINS INFORMATION THAT IS PROPRIETARY TO MOLEX INCORPORATED AND SHOULD NOT BE USED WITHOUT WRITTEN PERMISSION				

ADAPTER P/N	STYLE	TYPE	SLEEVE MAT'L	MODULE COLOR
1061541530	LC-LC	SINGLE MODE	ZIRCONIA	BLUE
1061541535	LC-LC/APC			GREEN
1061541531	LC-LC	MULTIMODE	PHOSPHOR BRONZE	BEIGE

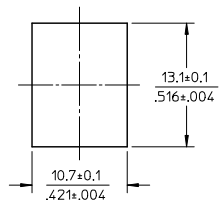
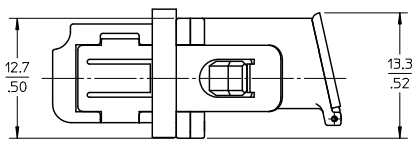
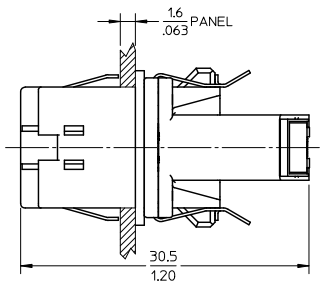

RECOMMENDED MOUNTING CUTOUT
(1.6mm THICK PANEL)

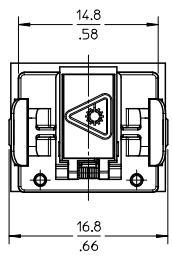

NOTES:
 1. ALL DIMENSIONS ARE FOR REFERENCE ONLY.
 2. PACKAGING: ADAPTERS AND DUSTCAPS ARE PACKED IN A PLASTIC TRAY.

ENTER DESCRIPTION EC NO: MF2010-0212 DRAWN: SERNST CHKD: SMIGO APPR: SMIGO 2009/11/09 2009/11/11 2009/11/11	QUALITY SYMBOLS	GENERAL TOLERANCES (UNLESS SPECIFIED) mm INCH 4 PLACES ± --- ± --- 3 PLACES ± --- ± --- 2 PLACES ± --- ± --- 1 PLACE ± --- ± --- ANGULAR ± 1 °	DIMENSION STYLE	SCALE	DESIGN UNITS	THIRD ANGLE PROJECTION
	▽=0 ▽=0		MM/IN	2.5:1	METRIC	
	DRAFT WHERE APPLICABLE MUST REMAIN WITHIN DIMENSIONS	DRAWN BY: SERNST DATE: 2006/02/13 CHECKED BY: DSZILAGYI DATE: 2006/03/07 APPROVED BY: SMIGO DATE: 2006/03/07	TITLE	UNIVERSAL EMI ADAPTER		
	A4	MATERIAL NO. SEE TABLE	MOLEX INCORPORATED DOCUMENT NO. SD-106154-001	SHEET NO.	7 OF 10	

ADAPTER P/N	STYLE	TYPE	SLEEVE MAT'L	MODULE COLOR
1061541500	LC-SC	SM OR MM	NICKEL	BEIGE

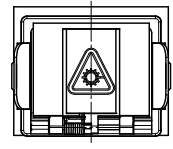
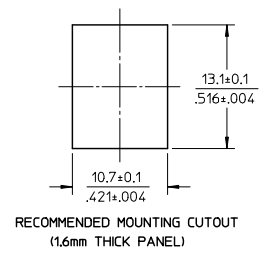
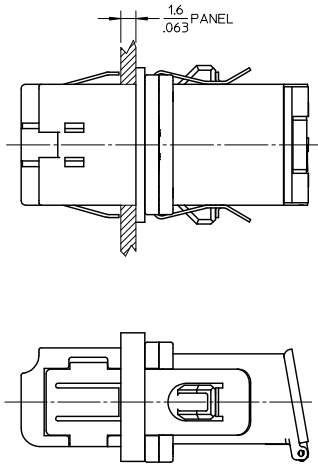

NOTES:
 1. ALL DIMENSIONS ARE FOR REFERENCE ONLY.
 2. PACKAGING: ADAPTERS AND DUSTCAPS ARE PACKED IN A PLASTIC TRAY.

ENTER DESCRIPTION EC NO: MF2010-0212 DRAWN: SERNST CHKD: DSZILAGYI APPR: SMIGO	QUALITY SYMBOLS ▽=0 ▽=0	GENERAL TOLERANCES (UNLESS SPECIFIED)		DIMENSION STYLE MM/IN	SCALE 2.5:1	DESIGN UNITS METRIC	THIRD ANGLE PROJECTION	
		4 PLACES ± --- ± ---	DRAWN BY SERNST	DATE 2006/02/13	TITLE UNIVERSAL EMI ADAPTER			
		3 PLACES ± --- ± ---	CHECKED BY DSZILAGYI	DATE 2006/03/07	MOLEX MOLEX INCORPORATED			
		2 PLACES ± --- ± ---	APPROVED BY SMIGO	DATE 2006/03/07	MATERIAL NO. SEE TABLE	DOCUMENT NO. SD-106154-001	SHEET NO. 8 OF 10	
1 PLACE ± --- ± ---	ANGULAR ± 1 °	DRAFT WHERE APPLICABLE MUST REMAIN WITHIN DIMENSIONS		THIS DRAWING CONTAINS INFORMATION THAT IS PROPRIETARY TO MOLEX INCORPORATED AND SHOULD NOT BE USED WITHOUT WRITTEN PERMISSION				

ADAPTER P/N	STYLE	TYPE	SLEEVE MAT'L	MODULE COLOR
1061541510	LC-FC	SM OR MM	NICKEL	BEIGE

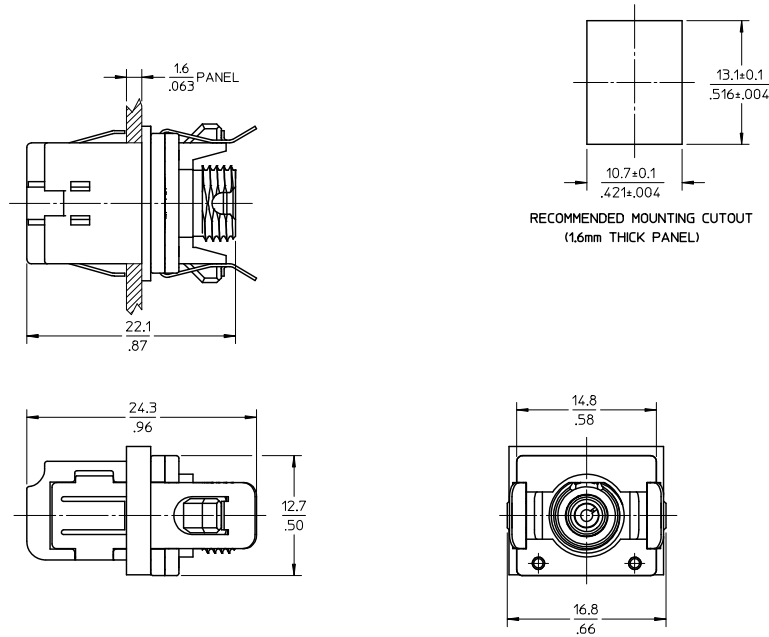

RECOMMENDED MOUNTING CUTOUT
(1.6mm THICK PANEL)

- NOTES:
 1. ALL DIMENSIONS ARE FOR REFERENCE ONLY.
 2. PACKAGING: ADAPTERS AND DUSTCAPS ARE PACKED IN A PLASTIC TRAY.

ENTER DESCRIPTION EC NO: MF2010-0212 DRAWN: SERNST CHKD: SMIGO APPR: SMIGO 2009/11/09 2009/11/11 2009/11/11	QUALITY SYMBOLS	GENERAL TOLERANCES (UNLESS SPECIFIED) mm INCH 4 PLACES ± --- ± --- 3 PLACES ± --- ± --- 2 PLACES ± --- ± --- 1 PLACE ± --- ± --- ANGULAR ± 1 °	DIMENSION STYLE	SCALE	DESIGN UNITS	THIRD ANGLE PROJECTION	
	▽=0		MM/IN	2.5:1	METRIC		
	▽=0		DRAWN BY	DATE	TITLE		
			SERNST	2006/02/13	UNIVERSAL EMI ADAPTER		
A4 REV	DRAFT WHERE APPLICABLE MUST REMAIN WITHIN DIMENSIONS	APPROVED BY	DATE	MATERIAL NO.			
		SMIGO	2006/03/07	DOCUMENT NO.			
				SD-106154-001			
		SIZE	THIS DRAWING CONTAINS INFORMATION THAT IS PROPRIETARY TO MOLEX INCORPORATED AND SHOULD NOT BE USED WITHOUT WRITTEN PERMISSION				
		B	SHEET NO. 9 OF 10				

ADAPTER P/N	STYLE	TYPE	SLEEVE MAT'L	MODULE COLOR
1061541520	LC-ST	SM OR MM	NICKEL	BEIGE

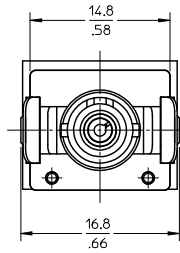
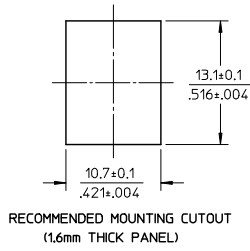
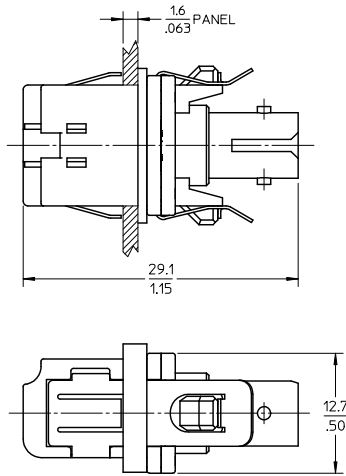

- NOTES:
1. ALL DIMENSIONS ARE FOR REFERENCE ONLY.
 2. PACKAGING: ADAPTERS AND DUSTCAPS ARE PACKED IN A PLASTIC TRAY.

ENTER DESCRIPTION EC NO: MF2010-0212 DRAWN: SERNST CHKD: 2009/11/11 APPR: SMIGO 2009/11/11	QUALITY SYMBOLS ▽=0 ▽=0	GENERAL TOLERANCES (UNLESS SPECIFIED)		DIMENSION STYLE	SCALE	DESIGN UNITS	THIRD ANGLE PROJECTION	
		mm	INCH	MM/IN	2.5:1	METRIC		
		4 PLACES ± --- ± ---		DRAWN BY	DATE	TITLE		
		3 PLACES ± --- ± ---		SERNST	2006/02/13	UNIVERSAL EMI ADAPTER		
2 PLACES ± --- ± ---		CHECKED BY	DATE	MOLEX INCORPORATED DOCUMENT NO. SD-106154-001 SHEET NO. 10 OF 10				
1 PLACE ± --- ± ---		DSZILAGYI	2006/03/07					
ANGULAR ± 1 °		APPROVED BY	DATE	THIS DRAWING CONTAINS INFORMATION THAT IS PROPRIETARY TO MOLEX INCORPORATED AND SHOULD NOT BE USED WITHOUT WRITTEN PERMISSION				
DRAFT WHERE APPLICABLE MUST REMAIN WITHIN DIMENSIONS		MATERIAL NO.	DATE					
REV A4		SEE TABLE	2006/03/07					