

LOC	DIST	REVISIONS					
E	B	P	LTR	DESCRIPTION	DATE	DWN	APVD
			BA1	AS PER ECR-09-006166	17-MAR-09	SM	JC

FOR FURTHER INFORMATION SEE DATA SHEET FOR
CPF SERIES-THIN FILM PRECISION CHIP RESISTORS

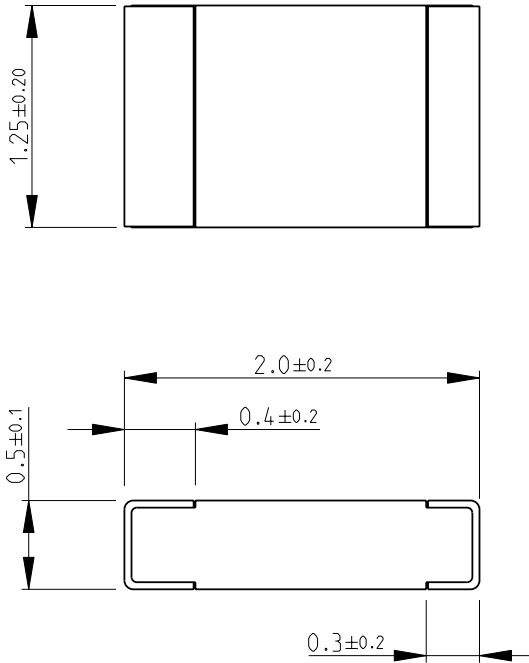

RoHS Compliant

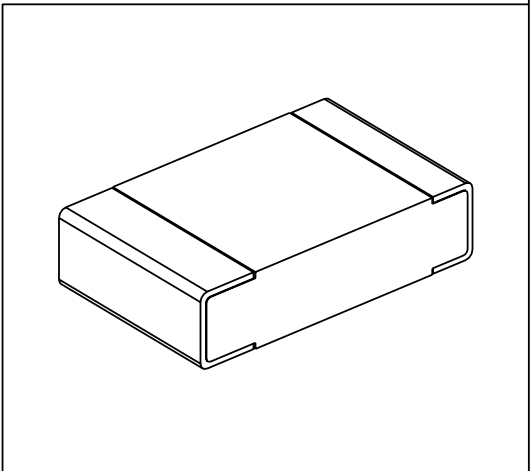

2008

RELEASED FOR PUBLICATION

THIS DRAWING IS UNPUBLISHED.

© COPYRIGHT 2008 BY TYCO ELECTRONICS CORPORATION. ALL RIGHTS RESERVED.

DIMENSIONS: mm	DWN	SUBHASH.M	22-Sep-08	MATERIAL	-	FINISH	-
	CHK	PRAKASH.S	22-Sep-08	Tyco Electronics Corporation Dorcan, Swindon, SN3 5HH			
TOLERANCES UNLESS OTHERWISE SPECIFIED:	APVD	STEPHEN.P	22-Sep-08				
0 PLC ± 0.2	PRODUCT SPEC	-	NAME	THIN FILM PRECISION CHIP RESISTORS SERIES CPF 0805			
1 PLC ± 0.1	APPLICATION SPEC	-	SIZE	CAGE CODE	DRAWING NO	RESTRICTED TO	
2 PLC \pm	WEIGHT	-	A 4	00779	© = 1614883	-	
3 PLC \pm			CUSTOMER DRAWING				
4 PLC \pm			SCALE	25:1	SHEET	1 OF 1	REV
ANGLES $\pm 5^\circ$							BA1