

BNC



BNC Connectors

BNC Connectors

Description

Developed in the late 1940's as a miniature version of the Type C connector, BNC stands for Bayonet Neill Concelman and is named after Amphenol engineer Carl Concelman. The BNC product line is a miniature quick connect/disconnect RF connector. It features two bayonet lugs on the female connector; mating is achieved with only a quarter turn of the coupling nut. BNC's are ideally suited for cable termination for miniature to subminiature coaxial cable (RG-58, 59, to RG-179, RG-316, etc.)

Amphenol 50 Ω BNC connectors are miniature, lightweight units useable up to 11 GHz and typically yield low reflection through 4 GHz. Designed to accommodate a large variety of RG and industry standard cables, BNC connectors are available in crimp/crimp, clamp/solder, SURETWIST[®], and field serviceable termination styles. A full line of printed circuit board receptacles, bulkhead receptacles, resistor terminations, and other accessories complement the product offering.

A variety of our 50 Ω BNC connectors are recognized under the Component program of Underwriter's Laboratories, Inc. These connectors are ideal for use with medical equipment and test instrumentation where safety cannot be compromised.

Amphenol also offers a full line of 75 Ω BNC connectors to meet the needs for higher performance impedance-matched cable interconnections. These connectors can be used in a variety of applications where true 75 Ω performance is needed to insure low signal distortion. Designed for the most popular 75 Ω cables used in broadcast and telecommunications applications as well as for plenum and other cables, these connectors feature crimp-crimp cable affixment for quick and reliable installation.

Part numbers that are listed with the appropriate M39012 number are military grade connectors produced in accordance with and actively qualified to the military specification MIL-C-39012. Connectors not listed with the M39012 number constitute the industrial grade product offering. These connectors provide comparable performance and generally feature nickel-plated brass bodies, Teflon insulators, and either gold or silver-plated center contacts. Amphenol's commercial grade connector offering carries the part number designation "RFX" for easy recognition. These low-cost connectors typically utilize die cast and molded components.

Reverse Polarity BNC's are also available. Reverse polarity is a keying system accomplished with a reverse interface, and ensures that reverse polarity interface connectors do not mate with standard interface connectors. Amphenol accomplishes this by inserting female contacts into plugs and male contacts into jacks. Other manufacturers may use reverse threading to accomplish reverse polarity keying.

Features/Benefits

- Bayonet coupling mechanism provides quick mating and unmating
- 50 Ω and 75 Ω impedance designs allow customers to match system requirements
- 50 Ω and 75 Ω connectors are intermateable
- Four grades of connectors are available for military, industrial, commercial and performance applications

Applications

- Antennas
- Base Stations
- Broadcast
- Cable Assemblies
- Computers/LANs
- Radios
- Satellite Communications
- Surge Protection
 - Telecom
- Instrumentation
- Oscilloscopes
- Medical Equipment

50 Ω BNC Specifications

Electrical

Impedance	50 Ω nominal
Frequency range	DC - 4 GHz (usable to 11 GHz)
VSWR	1.3 max. @ DC - 4 GHz (straight) 1.35 max. @ DC - 4 GHz (right-angle)
RF-leakage	55 dB minimum @ 3 GHz
Voltage rating (at sea level)	≥ 500 V peak (depending on cable)
Contact resistance	center contact: ≤ 1.5 mΩ outer contact: ≤ 0.2 mΩ braid to body: ≤ 0.1 mΩ
Insulation resistance	5,000 MΩ minimum
Insertion loss maximum	0.2 dB max. @ 3 GHz
Dielectric withstanding voltage	1,500 Vrms (at sea level)

Mechanical

Mating	2-stud bayonet lock coupling (MIL-STD-348)
Attachment method (inner / outer)	Crimp, clamp
Coupling torque, min./max.	0.6 / 2.5 in-lbs (7 / 28 N-cm)
Coupling nut retention force	101 lbs (450N) min.
Center contact retention force	≥ 6.1 lbs (27N)
Braid/Jacket cable affixment	Hex crimp or screw-threaded clamps
Center conductor cable affixment	Crimp or solder
Engagement force	≤ 5 lbs (22N)
Disengagement force	≥ 1.5 lbs (7N)
Durability (matings)	500 cycles minimum

Environmental

Temperature range	-65°C to +165°C
- copolymer of styrene:	-55°C to +85°C
Hermetic seals	Helium leak test, 2 x 10 ⁸ cc/sec.
Thermal shock	MIL-STD-202, method 102, cond. D
Moisture resistance	MIL-STD-202, method 106
Corrosion	MIL-STD-202, method 101, cond. B
Vibration	MIL-STD-202, method 204, cond. D
Mechanical shock	MIL-STD-202, method 202
Altitude	MIL-STD-202, method 105, cond. C

Note: These characteristics are typical but may not apply to all connectors.

50 Ω BNC Specifications (continued)

Material

Body and outer contacts	Brass, nickel plated
Male contact	Brass, gold plated
Female contact	Beryllium copper or phosphor bronze, gold or silver plated
Crimp ferrule	Copper or brass, nickel plated
Other metal parts	Brass, nickel plated (except M39012 silver plated)
Insulator	PTFE, copolymer of styrene, glass TFE (hermetically sealed)
Gasket	Silicone rubber

Military

MIL-C-39012

where applicable

Plug

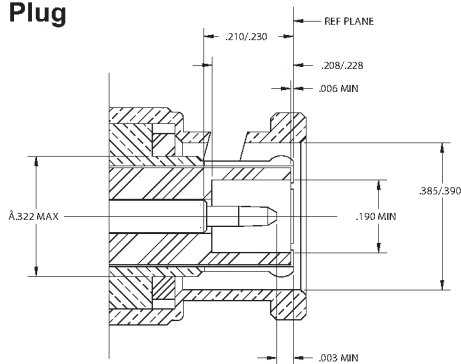

Jack

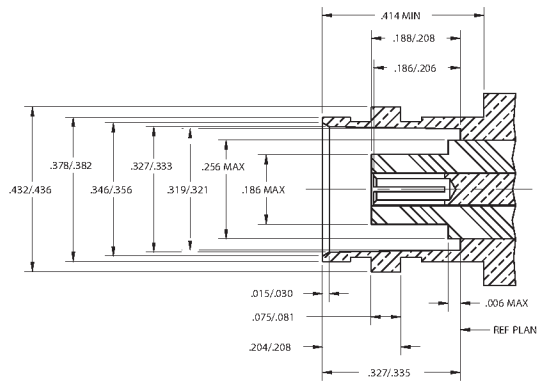

75 Ω BNC Specifications

Electrical

Impedance	75 Ω nominal
Frequency range	Type 1: DC – 4 GHz (performance grade useable to 6 GHz) Type 2: DC – 1 GHz
VSWR	Type 1: 1.5 + 0.1 f (GHz) DC – 4 GHz Type 1 (Performance grade): 1.16 max. @ DC – 3 GHz Type 2: 1.0 + 0.25 f (GHz) DC – 1 GHz
RF-leakage	55 dB minimum @ 3 GHz
Voltage rating (at sea level)	≥ 500 Vrms (depending on cable)
Contact resistance	center contact: ≤ 1.5 mΩ outer contact: ≤ 0.2 mΩ braid to body: ≤ 0.1 mΩ
Insulation resistance	5,000 MΩ minimum
Insertion loss maximum	0.2 dB max. @ 3 GHz
Dielectric withstanding voltage	1,500 Vrms (at sea level)

Mechanical

Mating	2-stud bayonet lock coupling (MIL-STD-348)
Attachment method (inner / outer)	Crimp, clamp
Coupling torque, min./max.	0.6 / 2.5 in-lbs (7 / 28 N-cm)
Coupling nut retention force	101 lbs (450N) min.
Center contact retention force	≥ 6.1 lbs (27N)
Braid/Jacket cable affixment	Hex crimp
Center conductor cable affixment	Crimp or solder
Engagement force	≤ 5 lbs (22N)
Disengagement force	≥ 1.5 lbs (7N)
Durability (matings)	500 cycles minimum

Environmental

Temperature range	-65°C to +165°C
Thermal shock	MIL-STD-202, method 102, cond. D
Moisture resistance	MIL-STD-202, method 106
Corrosion	MIL-STD-202, method 101, cond. B
Vibration	MIL-STD-202, method 204, cond. D
Mechanical shock	MIL-STD-202, method 202
Altitude	MIL-STD-202, method 105, cond. C

Material

Body and outer contacts	Brass or phosphor bronze, nickel plated
Male contact	Brass, gold plated
Female contact	Beryllium copper or phosphor bronze, silver or gold plated
Crimp ferrule	Copper or brass, nickel plated
Other metal parts	Brass, nickel plated
Insulator	PTFE
Gasket	Silicone rubber

Military

MIL-C-39012 where applicable

Plug

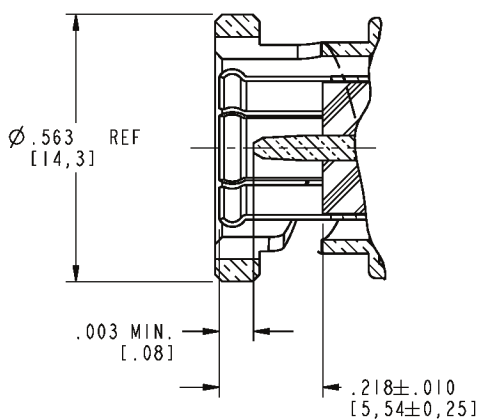

Jack

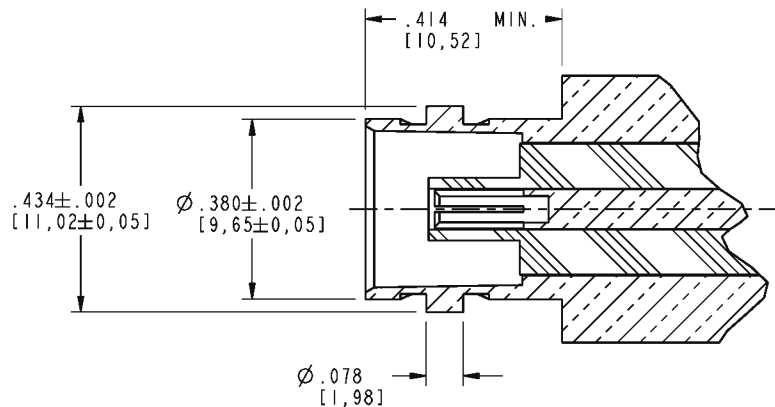

Note: These characteristics are typical but may not apply to all connectors.

50Ω Cable Connectors

Straight Crimp Plugs



Cable		Plating		Termination		Grade
Group	Part Number	Body	Contact	Body	Contact	
B	031-315	Nickel	Gold	Crimp	Crimp	Industrial
B	031-315-RFX	Nickel	Gold	Crimp	Crimp	Commercial
B1	031-242	Nickel	Gold	Crimp	Crimp	Industrial
B1	031-242-RFX	Nickel	Gold	Crimp	Crimp	Commercial
B2	031-315-1005	Nickel	Gold	Crimp	Crimp	Industrial
C	031-320	Nickel	Gold	Crimp	Crimp	Industrial
C	031-320-RFX	Nickel	Gold	Crimp	Crimp	Commercial
C	031-4320 (QPL)	Silver	Gold	Crimp	Crimp	Industrial
C	031-5800	Nickel	Gold	Crimp	Solder	Commercial
C1	031-326	Nickel	Gold	Crimp	Crimp	Industrial
C1	031-326-RFX	Nickel	Gold	Crimp	Crimp	Commercial
C1	031-4427 (QPL)	Silver	Gold	Crimp	Crimp	Industrial
D	031-320-1006	Nickel	Gold	Crimp	Crimp	Industrial
E	031-321	Nickel	Gold	Crimp	Solder	Industrial
E	031-321-RFX	Nickel	Gold	Crimp	Crimp	Commercial
E	031-4321 (QPL)	Silver	Gold	Crimp	Crimp	Industrial
E	031-5900	Nickel	Gold	Crimp	Solder	Commercial
E	000-68175-1005	Nickel	Gold	Crimp	Crimp	Industrial
E	000-68175-11RFX	Nickel	Gold	Crimp	Crimp	Commercial
E1	000-68175-5RFX	Nickel	Gold	Crimp	Crimp	Commercial
E2	031-321-1000	Nickel	Gold	Crimp	Crimp	Industrial
F	000-68175-1003	Nickel	Gold	Crimp	Crimp	Industrial
G2	031-5999-RFX	Nickel	Gold	Crimp	Crimp	Commercial
G2	031-6006	Nickel	Gold	Crimp	Crimp	Commercial
G3	031-5998-RFX	Nickel	Gold	Crimp	Crimp	Commercial
H2	031-4411	Nickel	Gold	Crimp	Crimp	Industrial
K3	031-325	Nickel	Gold	Crimp	Crimp	Industrial

Angle Crimp Plugs



Cable		Plating		Termination		Grade
Group	Part Number	Body	Contact	Body	Contact	
B	031-316	Nickel	Gold	Crimp	Crimp	Industrial
C	031-335	Nickel	Gold	Crimp	Crimp	Industrial
C	031-335-RFX	Nickel	Gold	Crimp	Crimp	Commercial
E	031-336	Nickel	Gold	Crimp	Crimp	Industrial
E	031-336-RFX	Silver	Gold	Crimp	Crimp	Commercial
G2	031-6005-RFX	Nickel	Gold	Crimp	Solder	Commercial
G3	031-6004-RFX	Nickel	Gold	Solder	Crimp	Commercial

Press Fit Plugs

Cable Group	Part Number	Plating		Termination		Grade
		Body	Contact	Body	Contact	
C	031-5557-RFX	Nickel	Gold	Crimp	Press Fit	Commercial
D	031-5559-RFX	Nickel	Gold	Crimp	Press Fit	Die Cast
E	031-5556-RFX	Nickel	Gold	Crimp	Press Fit	Commercial
G1	031-5558-RFX	Nickel	Gold	Crimp	Press Fit	Commercial

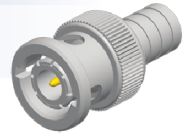

Straight Clamp Plugs

Cable Group	Part Number	Plating		Termination		Grade
		Body	Contact	Body	Contact	
A	000-15875	Nickel	Silver	Clamp	Solder	Industrial
B	000-69475	Nickel	Silver	Clamp	Solder	Industrial
C	031-202	Nickel	Silver	Clamp	Solder	Industrial
C	031-2-RFX	Nickel	Gold	Clamp	Solder	Commercial
C	031-3301 (QPL)	Silver	Gold	Clamp	Solder	Industrial
E	031-212	Nickel	Silver	Clamp	Solder	Industrial
E	031-212-1005	Nickel	Silver	Clamp	Solder	Industrial
E	031-212-RFX	Nickel	Gold	Clamp	Solder	Commercial
E	031-3302 (QPL)	Silver	Gold	Clamp	Solder	Industrial
G4	000-6775	Nickel	Silver	Clamp	Solder	Industrial



Sure Twist® Plugs

Cable Group	Part Number	Plating		Termination		Grade
		Body	Contact	Body	Contact	
C	031-5137	Nickel	Tin	Twist On		Industrial
C	031-5137-RFX	Nickel	Gold	Twist On		Commercial
E	031-5136	Nickel	Matte Tin	Twist On		Industrial
E	031-5136-RFX	Nickel	Gold	Twist On		Commercial

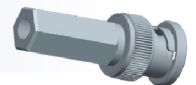

50Ω Cable Connectors (continued)

Straight Crimp Jacks

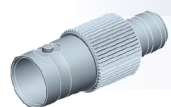

Cable		Plating		Termination		Grade
Group	Part Number	Body	Contact	Body	Contact	
B	031-317	Nickel	Gold	Crimp	Crimp	Industrial
C	031-4327 (QPL)	Silver	Gold	Crimp	Crimp	Industrial
C	000-36800-RFX	Nickel	Gold	Crimp	Crimp	Commercial
C	000-36800	Nickel	Gold	Crimp	Crimp	Industrial

Straight Clamp Jacks

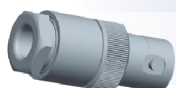

Cable		Plating		Termination		Grade
Group	Part Number	Body	Contact	Body	Contact	
C1	031-5	Nickel	Gold	Clamp	Solder	Industrial
E	031-15	Nickel	Silver	Clamp	Solder	Industrial

Straight Bulkhead Crimp Jacks

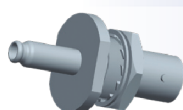

Cable		Plating		Termination		Grade
Group	Part Number	Body	Contact	Body	Contact	
B	031-318	Nickel	Gold	Crimp	Crimp	Industrial
B	031-318-RFX	Nickel	Gold	Crimp	Crimp	Commercial
C	031-342	Nickel	Gold	Crimp	Crimp	Industrial
C	031-342-RFX	Nickel	Gold	Crimp	Crimp	Commercial
E	031-343-RFX	Nickel	Gold	Crimp	Solder	Commercial

Straight Bulkhead Clamp Jacks

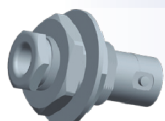

Cable		Plating		Termination		Grade
Group	Part Number	Body	Contact	Body	Contact	
C	031-206	Nickel	Silver	Clamp	Solder	Industrial
E	031-207	Nickel	Silver	Clamp	Solder	Industrial
B	000-86350	Nickel	Silver	Clamp	Solder	Industrial

50Ω Receptacles

Straight Panel Jacks



Part Number	Plating		Terminal Type	Description	Grade
	Body	Contact			
031-105	Nickel	Silver	Solder Cup	4-hole Square Flange .120" Dia.	Industrial
031-203	Nickel	Silver	Solder Cup	4-hole Square Flange No. 3-56	Industrial
031-203-RFX	Nickel	Gold	Solder Cup	4-hole Square Flange .125" Dia.	Commercial
000-4500	Nickel	Silver	Turret	4-hole Square Flange .136" Dia.	Industrial

Front Mount Bulkhead Panel Jacks

Part Number	Plating		Terminal Type	Description	Grade
	Body	Contact			
031-10	Nickel	Silver	Solder Cup	Isolated	Industrial
031-10-RFX	Nickel	Silver	Solder Cup	Isolated	Commercial
031-102	Nickel	Silver	Solder Cup	Pressurized	Industrial
031-221	Nickel	Silver	Solder Cup		Industrial
031-221-RFX	Nickel	Gold	Solder Cup		Commercial
031-2221	Nickel	Silver	Solder Cup		Industrial
031-236	Nickel	Silver	Solder Cup		Industrial
031-239	Nickel	Silver	Solder Cup	Pressurized	Industrial
031-3376 (QPL)	Silver	Gold	Solder Cup		Industrial
031-4238 (QPL)	Silver	Gold	Eyelet	Hermetic	Industrial
031-4890-1	Silver	Silver	Solder Cup	Isolated	Industrial

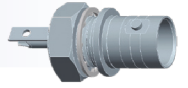

Rear Mount Bulkhead Panel Jacks

Part Number	Plating		Terminal Type	Description	Grade
	Body	Contact			
031-237 (QPL)	Silver	Gold	Eyelet	Rear Mount, Hermetic	Industrial

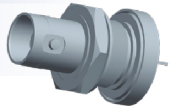

Angle Bulkhead Panel Jacks

Part Number	Plating		Terminal Type	Description	Grade
	Body	Contact			
031-222	Nickel	Silver	Solder Cup	With Tooth Lockwasher	Industrial

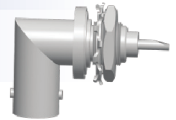

50Ω Printed Circuit Board Connectors

Straight Jacks

Part Number	Plating		Mounting Style	Grade	Description
	Body	Contact			
031-5633	Nickel	Gold	Blunt Post	Industrial	
031-5493-1010	Nickel	Gold	Compliant Pin	Industrial	
031-5633-1010	Nickel	Gold	Compliant Pin	Industrial	
000-18225	Nickel	Silver	Blunt Post (Sq.)	Industrial	4 Leg Post Terminal .040(1.0), Dia. X .125(3.2) Long
031-5329	Nickel	Gold	Blunt Post (Flush)	Industrial	3 Leg Long Post Terminal .040(1.0), Dia. X .125(3.2) Long/.025(0.6)
031-5329-51RFX	Nickel	Silver	Blunt Post (Lip)	Commercial	4 Legs .176(4.5) Long/Post Terminal, .037(0.9) Dia
031-5329-52RFX	Nickel	Gold	Blunt Post (Lip)	Commercial	4 Legs .176(4.5) Long/Post Terminal, .037(0.9) Dia



50Ω Printed Circuit Board Connectors (continued)

Angle Jacks

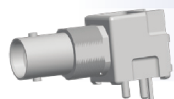

Part Number	Plating		Mounting Style	Grade	Description
	Body	Contact			
031-5640	Nickel	Gold	Blunt Post	Industrial	
031-5640-1010	Nickel	Gold	Compliant Pin	Industrial	
031-5431	Nickel	Gold	Blunt Post	Industrial	
031-5538-1010	Nickel	Gold	Compliant Pin	Industrial	
031-5431-1010	Nickel	Gold	Compliant Pin	Industrial	White Plastic Housing
031-5431-10RFX	Nickel	Gold	Compliant Pin	Commercial	White Plastic Housing
031-5486-10RFX	Nickel	Gold	Compliant Pin	Commercial	White Plastic Housing
031-5538	Nickel	Gold	Blunt Post	Industrial	Black Plastic Housing
031-5538-10RFX	Nickel	Gold	Compliant Pin	Commercial	Black Plastic Housing

Low Profile Angle Jacks

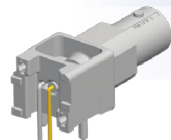

Part Number	Body	Plating		Mounting Style	Grade
		Contact	Grade		
031-5637	Nickel	Gold	Blunt Post	Industrial	
031-5540-1010	Nickel	Gold	Compliant Pin	Industrial	

Straight Bulkhead Jacks



Part Number	Body	Plating		Description	Grade
		Contact	Mounting Style		
031-5493	Nickel	Gold	Blunt Post	White Plastic Housing	Industrial
031-5539	Nickel	Gold	Blunt Post	Black Plastic Housing	Industrial
031-5539-1010	Nickel	Gold	Blunt Post	Black Plastic Housing	Industrial

Low Profile Angle Bulkhead Jacks

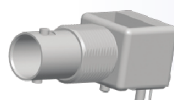

Part Number	Body	Plating		Description	Grade
		Contact	Mounting Style		
031-5486	Nickel	Gold	Blunt Post	White Plastic Housing	Industrial
031-5486-1010	Nickel	Gold	Compliant Pin	White Plastic Housing	Industrial
031-5540	Nickel	Gold	Blunt Post	Black Plastic Housing	Industrial

50Ω Adapters

Straight Plug-Plug



Part Number	Body	Plating		Description	Grade
		Contact	Grade		
031-218	Nickel	Silver	Blunt Post	Straight, Plug-Plug	Industrial
031-218-RFX	Nickel	Gold	Blunt Post	Straight, Plug-Plug	Commercial

Straight Jack-Jack



Part Number	Body	Plating		Grade
		Contact	Grade	
031-219	Nickel	Silver	Blunt Post	Industrial
031-219-RFX	Nickel	Silver	Blunt Post	Commercial

Straight Jack-Jack, Panel Mount

Part Number	Body	Plating		Grade
		Contact	Grade	
000-47000	Nickel	Gold	Industrial	

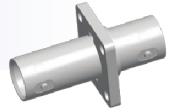

Angle Jack-Plug

Part Number	Body	Plating		Grade
		Contact	Grade	
031-9	Nickel	Silver	Industrial	
031-9-RFX	Nickel	Gold	Commercial	

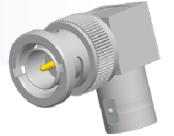

Straight Jack-Jack Bulkhead Adapters

Part Number	Body	Plating		Description	Grade
		Contact	Grade		
031-220G-RFX	Nickel	Gold	Commercial	Gasket Sealed	Commercial
031-220H	Nickel	Silver	Industrial	Pressurized	Industrial
031-220N	Nickel	Silver	Industrial		Industrial
031-220N-RFX	Nickel	Gold	Commercial		Commercial
031-3220	Silver	Silver	Industrial	Pressurized	Industrial



T-Adapters

Part Number	Body	Plating		Description	Grade
		Contact	Grade		
000-21900	Nickel	Silver	Industrial	Plug-Jack-Jack	Industrial
031-208	Nickel	Silver	Industrial	Jack-Plug-Jack	Industrial
031-208-RFX	Nickel	Gold	Commercial	Jack-Plug-Jack	Commercial



50Ω Reverse Polarity Connectors

Straight Cable Plugs

Part Number	Plating		Termination		Grade
	Body	Contact	Body	Contact	
031-5705	Nickel	Gold	Crimp	Crimp	Commercial
031-5787-T	Nickel	Gold	Crimp	Crimp	Commercial
031-6034	Nickel	Gold	Crimp	Crimp	Commercial
031-6032	Nickel	Gold	Crimp	Crimp	Commercial
031-6035	Nickel	Gold	Crimp	Crimp	Commercial
031-6036	Nickel	Gold	Crimp	Crimp	Commercial

75Ω Cable Connectors

Straight Crimp-Crimp Plugs



Cable Group	Part Number	Plating		Type	Grade
		Body	Contact		
B	031-71013	Nickel	Gold	2	Industrial
B1	031-70013	Nickel	Gold	1	Industrial
B1	031-71013-RFX	Nickel	Gold	2	Commercial
E	031-70008	Nickel	Gold	1	Industrial
E	031-71008	Nickel	Gold	2	Industrial
E	031-71008-RFX	Nickel	Gold	2	Commercial
E	031-71032	Nickel	Gold	2	Industrial
E1	031-70008-3000	Nickel	Gold	1	Industrial
E1	031-71008-1000	Nickel	Gold	2	Industrial
E1	031-71008-1RFX	Nickel	Gold	2	Commercial
E2	031-70235	Nickel	Gold	1	Industrial
E3	031-71066	Nickel	Gold	2	Industrial
F	031-71008-2000	Nickel	Gold	2	Industrial
G1	031-70000	Nickel	Gold	1	Industrial
H1	031-70234	Nickel	Gold	1	Industrial
H1	031-71000-RFX	Nickel	Gold	2	Commercial
H3	031-71065	Nickel	Gold	2	Industrial
I	031-70237	Nickel	Gold	1	Industrial
I2	031-70238	Nickel	Gold	1	Industrial
K3	031-70236	Nickel	Gold	1	Industrial
K3, I2	031-71033	Nickel	Gold	2	Industrial

Angle Crimp-Crimp Plugs



Cable Group	Part Number	Plating		Type	Grade
		Body	Contact		
I	031-70239	Nickel	Gold	2	Industrial
I2	031-70240	Nickel	Gold	1	Industrial

Bulkhead Crimp-Crimp Jacks

Cable Group	Part Number	Plating		Type	Grade
		Body	Contact		
B1	031-71016-RFX	Nickel	Gold	2	Commercial
E	031-71011-RFX	Nickel	Gold	2	Commercial

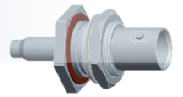

75Ω Receptacles

Bulkhead Solder Cup Jacks

Part Number	Plating		Terminal Type	Type	Grade
	Body	Contact			
031-10-75	Nickel	Gold	Solder Cup	2	Commercial
031-221-75RFX	Nickel	Gold	Solder Cup	2	Commercial
031-70018	Gold	Nickel	Solder Cup	1	Industrial
031-71004	Nickel	Gold	Solder Cup	2	Commercial

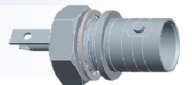

75Ω Printed Circuit Board Connectors

Straight Jacks

Part Number	Plating		Mounting Style	Type	Grade
	Body	Contact			
031-71045-1010	Nickel	Gold	Compliant Pin	2	Industrial
031-71058	Nickel	Gold	Blunt Post	2	Industrial
031-71062	Nickel	Gold	Thru-Hole (Blunt Post)	2	Industrial
031-6009	Nickel	Gold	Edge	2	Industrial
031-70040-100T	Nickel	Gold	Blunt Post	1	Industrial

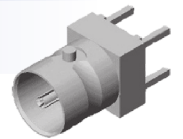

Angle Jacks

Part Number	Plating		Mounting Style	Type	Grade
	Body	Contact			
031-71043	Nickel	Gold	Blunt Post	2	Industrial
031-71043-1010	Nickel	Gold	Compliant Pin	2	Industrial
031-71052	Nickel	Gold	Blunt Post	2	Industrial
031-71052-10RFX	Nickel	Nickel	Compliant Pin, Blunt Post	2	Commercial
031-71053	Nickel	Gold	Blunt Post	2	Industrial
031-71053-1010	Nickel	Gold	Compliant Pin	2	Industrial

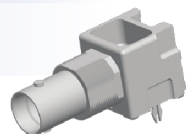

75Ω Printed Circuit Board Connectors (continued)

Straight Bulkhead Jacks



Part Number	Body	Plating		Mounting Style	Type	Grade
		Contact	Plating			
031-71059	Nickel	Gold	Blunt Post	2	Industrial	
031-71059-1010	Nickel	Gold	compliant Pin	2	Industrial	

Angle Bulkhead Jacks

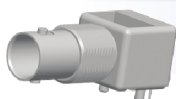

Part Number	Body	Plating		Mounting Style	Type	Grade
		Contact	Plating			
031-71042	Nickel	Gold	Blunt Post	2	Industrial	
031-71047-1010	Nickel	Gold	compliant Pin	2	Industrial	
031-70221	Nickel	Gold	Blunt Post	1	Industrial	

75Ω Adapters

Straight Plug-Plug



Part Number	Body	Plating		Type	Grade
		Contact	Plating		
031-218-75RFX	Nickel	Gold	2	Commercial	

Straight Jack-Jack



Part Number	Body	Plating		Type	Grade
		Contact	Plating		
031-70019	Nickel	Gold	1	Industrial	
031-220N-75	Nickel	Gold	2	Industrial	

Straight Bulkhead Jack-Jack

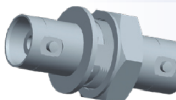

Part Number	Body	Plating		Type	Grade
		Contact	Description		
031-220N-75RFX	Nickel	Gold	Not Gasketed	2	Commercial
031-4803-75	Nickel	Gold	Isolated	2	Industrial
031-70020	Nickel	Gold	Gasketed	1	Industrial
031-219-75	Nickel	Gold	2	Commercial	

Angle Jack-Plug



Part Number	Body	Plating		Type	Grade
		Contact	Plating		
031-9-75	Nickel	Gold	2	Industrial	
031-9-75RFX	Nickel	Gold	2	Commercial	

T- Adapters



Part Number	Body	Plating		Type	Grade
		Contact	Plating		
031-70036	Nickel	Gold	1	Industrial	

Accessories

Terminations

Part Number	Plating		Description	Grade
	Body	Contact		
000-46650-51	Nickel	Silver	Male Cap, Resistor Terminated, 50 Ω	Industrial
000-46650-51RFX	Nickel	Gold	Male Cap, Resistor Terminated, 1% 1 watt, 50 Ω	Commercial
000-46650-75RFX	Nickel	Gold	Male Cap, Resistor Terminated, 1% 1 watt, 75 Ω	Commercial
000-46650-93RFX	Nickel	Gold	Male Cap, Resistor Terminated, 1% 1 watt, 90 Ω	Commercial



Caps & Chains

Part Number	Plating		Description	Grade
	Body	Contact		
000-35650-51	Nickel	Gold	Cap & Chain, Resistor Terminated, 50 Ω	Industrial
000-35650-75	Nickel	Gold	Cap & Chain, Resistor Terminated, 75 Ω	Industrial
031-17	Nickel	Silver	Male Shorting Cap & Chain	Industrial
031-6	Nickel	N/A	Cap & Chain	Industrial
031-6-RFX	Nickel	N/A	Cap & Chain	Commercial



Miscellaneous Accessories

Part Number	Plating	Quantity	Description	Grade
031-759	Nickel	Pkg. of 25	Shield Grounding Lug	Commercial
031-10152-RFX	Nickel	Pkg. of 25	Toothed Grounding Lug	Commercial
031-5663	N/A	1 ea.	4.8" x Diameter 1.3" piece of velcro	Industrial
000-5275	Nickel	1 ea.	Shorting Plug less chain	Industrial



Cable Group	Cable Type
A	RG-178, 196
B	RG-174, 188A, 316, Belden 7805
B1	RG-179, 187, Belden 9221
B2	RD-188/U, RD-316/U
B3	RD-179/U, AT&T 19224L2
C	RG-58, 58A, 58C, 141, 303, LMR195, Belden 7806A, 9907
C1	RG-55, 142, 223, 400
C2	LMR200, Belden 7807A
D	RG-58/U Plenum, Thinnet, RG-122/U, Belden 88240, 89907
E	RG-59, 62, 140, 210, Belden 8241, 8263, 8279, 9209
E1	RG-59/U 20 AWG center conductor, Belden 1426A, 1505A, 9100, 9278
E2	RD-59/U, Belden 8281, 9141, 9231
E3	RG-59/U Quad Shield, Belden 1152A
F	RG-59/U Plenum, Belden 1560A, 9259, 82259, 89259, 88241
F1	RG-59/U Plenum 20 AWG center conductor, Belden 82108
G1	RG-6, 143, 212
G2	8X, LMR240, Belden 7808A, 9258
G3	LMR400, Belden 7810A, 8214, 9913
G4	RG-8, 8A, 9, 87A, 213, 214, 225, 393
G5	RD-6/U
H	RG-11
H1	Belden 1694A, 9248
H2	Belden 1859A, 7731, 8213, 9292
H3	RG-54A/U
I	AT&T 734A, Belden 1505A
I2	AT&T 735A, Belden 735A1
J	Quad 59 headend cable
K	LMR600
K2	Belden 1695A
K3	RG-122, 180, 195, Belden 1855, 1865A, 8218
L	.141 semi-rigid, RG-402/U
L2	.085, .086, .087 semi-rigid, RG-405/U
L3	.250 semi-rigid
L4	.047 semi-rigid, Belden 1674
M	1/2 inch annular corrugated
M1	1 1/4 inch annular corrugated
M2	1 5/8 inch annular corrugated
M3	7/8 inch annular corrugated
N	1/4 Helical
N1	3/8 Helical
N2	1/2 Helical
N3	7/8 inch SFC
P1	.81 mm OD micro-cable
P2	1.13 mm OD micro-cable, TCB-068
P3	1.32 mm OD micro-cable
P4	1.37 mm OD micro-cable